



February 13, 2009

In Reply Refer To: HSSD/B-187

Ronald K. Faller, Ph.D.  
Research Assistant Professor  
Midwest Roadside Safety Facility  
University of Nebraska-Lincoln  
527 Nebraska Hall  
Lincoln, NE 68588-0529

Dear Dr. Faller:

This letter is in response to your request for the Federal Highway Administration (FHWA) acceptance of a roadside safety system for use on the National Highway System (NHS).

Name of system:	Midwest Guardrail System (MGS) Asymmetrical W-beam to Thrie Beam Transition
Type of system:	Longitudinal Barrier
Test Level:	NCHRP Report 350 TL3
Testing conducted by:	Midwest Roadside Safety Facility
Date of request:	October 13, 2008
Date of completed package:	November 26, 2007

You requested that we find this system acceptable for use on the NHS under the provisions of National Cooperative Highway Research Program (NCHRP) Report 350 "Recommended Procedures for the Safety Performance Evaluation of Highway Features."

### Requirements

Roadside safety systems should meet the guidelines contained in the NCHRP Report 350. FHWA Memorandum "ACTION: Identifying Acceptable Highway Safety Features" of July 25, 1997, provides further guidance on crash testing requirements of longitudinal barriers.

### Description

The test level 3 (TL-3) Midwest Guardrail System (MGS) Asymmetrical W-beam to Thrie Beam Transition system is 26.67-m (87-ft 6-in.) in length and consists of five major structural components: (1) a thrie beam channel bridge railing system; (2) nested 2.67-mm (12-gauge) thick thrie beam guardrail; (3) standard 2.67-mm (12-gauge) thick thrie beam guardrail; (4) a 3.43-mm (10-gauge) thick MGS asymmetrical W-beam to thrie beam transition section; and (5) standard 2.67-mm (12-gauge) thick W-beam rail attached to a simulated anchorage device. W-beam's top guardrail height was 787 mm (31 in.) with a 632-mm (24.875-in.) center mounting height.

The post size and embedment depth for this system included construction of three bridge posts and eighteen guardrail posts. Post numbers 1 and 2 were timber posts measuring 140 mm wide x 190 mm deep x 1,156 mm long (5.5 in. x 7.5 in. x 45.5 in.) and were placed in 1,829-mm (6-ft) long steel foundation tubes. The timber posts and foundation tubes were part of an anchorage system used to develop the required tensile capacity of a tangent guardrail terminal.

Post numbers 3 through 8 were galvanized ASTM A36 Steel W152 x 13.4 (W6 x 9) sections measuring 1,829 mm (6 ft) in length. Posts numbers 9 through 15 were galvanized ASTM A36 steel W152 x 17.9 (W6 x 12) sections measuring 2,286 mm (7.5 ft) in length.

Post numbers 16 through 18 were galvanized ASTM A36 steel W152 x 22.3 (W6 x 15) sections measuring 2,134 mm (7 ft) long.

Bridge post numbers 19 through 21 were galvanized ASTM A36 steel W152 x 29.8 (W6 x 20) sections measuring 752 mm (29.625 in.) long.

Post numbers 1 through 6 were spaced 1,905 mm (75 in.) on center, while post numbers 6 through 19 were spaced 953 mm (37.5 in.) on center, as shown in Figure 2. Post numbers 19 through 21 were spaced 1,905 mm (75 in.) on center.

The soil embedment depths for post numbers 3 through 8 was 1,016 mm (40 in.), 9 through 15 was 1,473 mm (58 in.), 16 is 1,391 mm (54.75 in.), 17 is 1,375 mm (54.125 in.), and 18 is 1,403 mm (55.25 in.).

The steel posts were placed in a compacted coarse, crushed limestone material that met Grading B of AASHTO M147-65 (1990) as found in NCHRP Report 350. For post numbers 3 through 11, 152-mm wide x 203-mm deep x 362-mm long (6-in. x 8-in. x 14.25-in.) wood spacer blockouts were used to block the rail away from the front face of the steel posts. For post number 12, a 152-mm wide x 305-mm deep x 483-mm long (6-in. x 12-in. x 19-in.) wood spacer blockout was used to block the rail away from the front face of the steel post. For post numbers 13 through 17, a 152-mm wide x 203-mm deep x 483-mm long (6-in. x 8-in. x 19-in.) wood spacer blockout was used to block the rail away from the front face of the steel post. For post number 18, a 152-mm wide x 203-mm deep x 381 mm long (6-in. x 8-in. x 15-in.) wood spacer blockout was used to block the rail away from the front face of the steel post. For post numbers 19 through 21, a galvanized ASTM A36 steel W152x22.3 (W6x15) section spacer blockout measuring 346 mm (13.625 in.) long was used to block the rail away from the front face of the steel bridge post.

### **Crash Testing**

The analysis of the crash test results showed that the MGS W-beam to three beam transition element, used in conjunction with an approach guardrail transition system, adequately contained and redirected the vehicle with controlled lateral displacements of the barrier system. There were no detached elements nor fragments which showed potential for penetrating the occupant compartment nor presented undue hazard to other traffic. Deformations of, or intrusion into, the occupant compartment that could have caused serious injury did not occur. The test vehicle did not penetrate nor ride over the barrier system and remained upright during and after the collision. Vehicle roll, pitch, and yaw angular displacements were noted, but they were deemed acceptable.

because they did not adversely influence occupant risk safety criteria nor cause rollover. After collision, the vehicle's trajectory revealed minimum intrusion into adjacent traffic lanes. Therefore, this crash test conducted on the MGS W-beam to thrie beam transition element, used in conjunction with an approach guardrail transition system, was determined to be acceptable according to the TL-3 safety performance criteria found in NCHRP Report 350.

### **Findings**

Therefore, the MGS Asymmetrical W-beam to Thrie Beam Transition system described above and detailed in the enclosed drawings is acceptable for use on the NHS under the range of conditions tested, when such use is acceptable to a highway agency.

Please note the following standard provisions that apply to the FHWA letters of acceptance:

- This acceptance is limited to the crashworthiness characteristics of the systems and does not cover their structural features, nor conformity with the Manual on Uniform Traffic Control Devices.
- Any changes that may adversely influence the crashworthiness of the system will require a new acceptance letter.
- Should the FHWA discover that the qualification testing was flawed, that in-service performance reveals unacceptable safety problems, or that the system being marketed is significantly different from the version that was crash tested, we reserve the right to modify or revoke our acceptance.
- You will be expected to supply potential users with sufficient information on design and installation requirements to ensure proper performance.
- You will be expected to certify to potential users that the hardware furnished has essentially the same chemistry, mechanical properties, and geometry as that submitted for acceptance, and that it will meet the crashworthiness requirements of the FHWA and the NCHRP Report 350.
- To prevent misunderstanding by others, this letter of acceptance is designated as number B-187 and shall not be reproduced except in full. This letter and the test documentation upon which it is based are public information. All such letters and documentation may be reviewed at our office upon request.
- This acceptance letter shall not be construed as authorization or consent by the FHWA to use, manufacture, or sell any patented system for which the applicant is not the patent holder. The acceptance letter is limited to the crashworthiness characteristics of the candidate system, and the FHWA is neither prepared nor required to become involved in issues concerning patent law. Patent issues, if any, are to be resolved by the applicant.

Sincerely yours,



David A. Nicol  
Director, Office of Safety Design  
Office of Safety

Enclosures

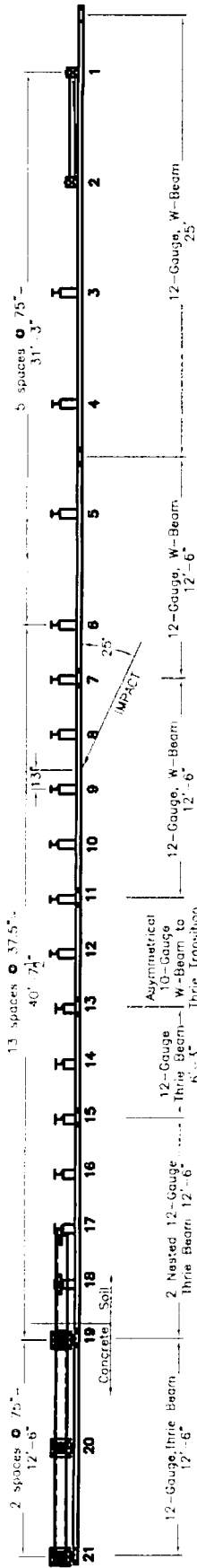

**Plan**

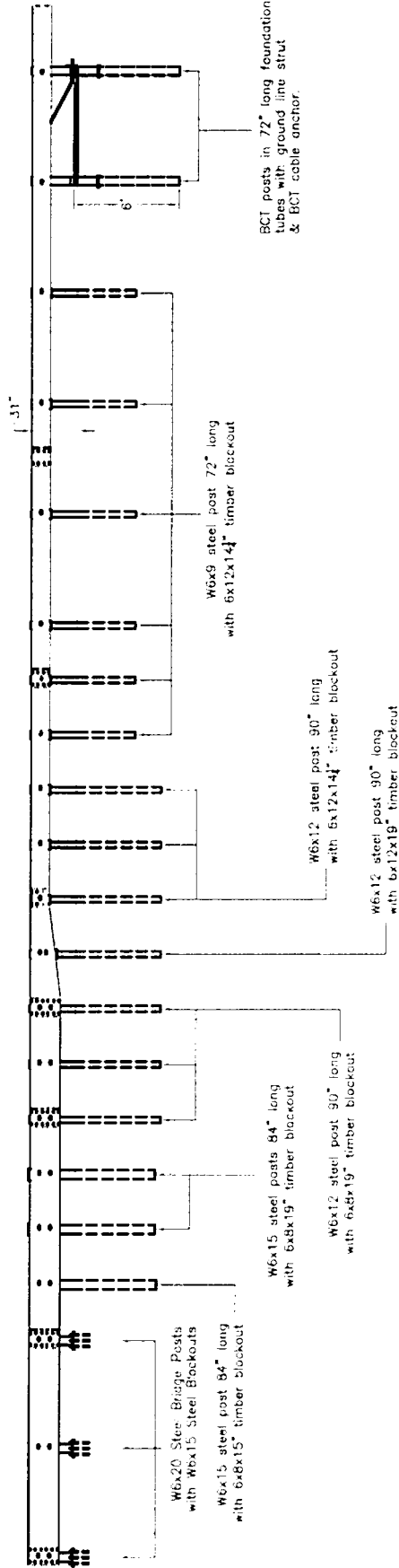

**Profile**



**Midwest Roadside Safety Facility**

**W-BEAM TO STIFF BRIDGE TRANSITION MWT-5 LAYOUT**

Drawing Name: MWT-5 R8.dwg

Scale: None

Sheet: I of 13	Scale: None
Date: 08/24/2007	Rev: EMA
By: GEP	

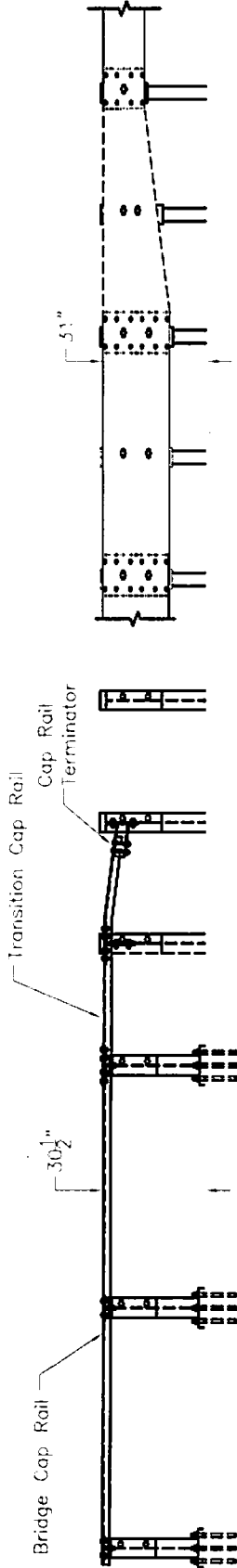
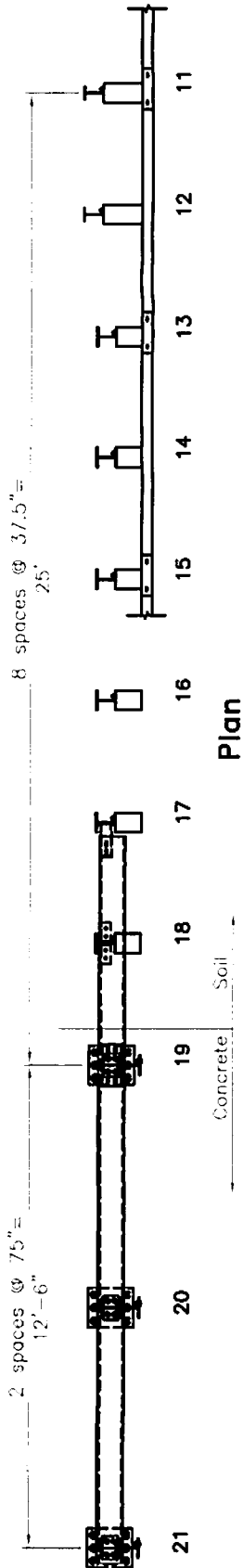

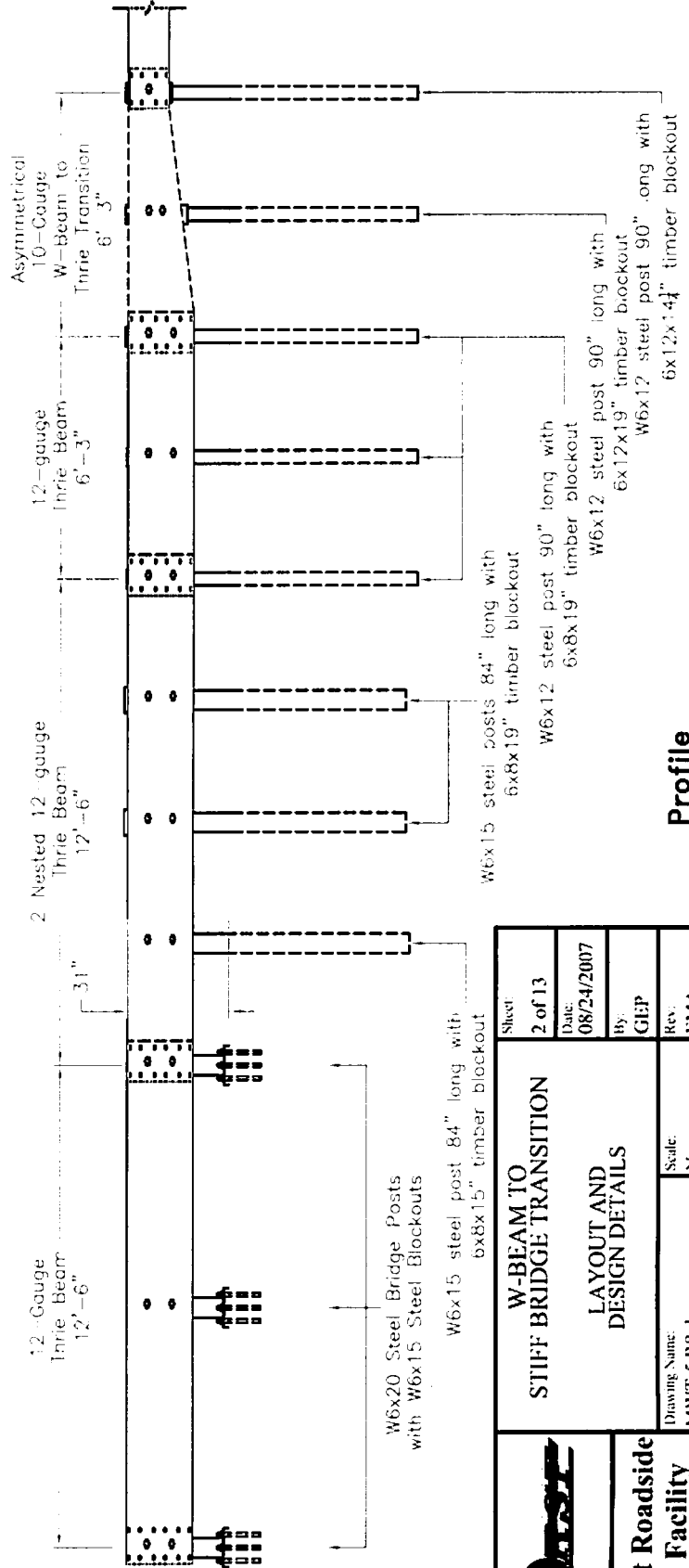

**Profile - Cap Rail**

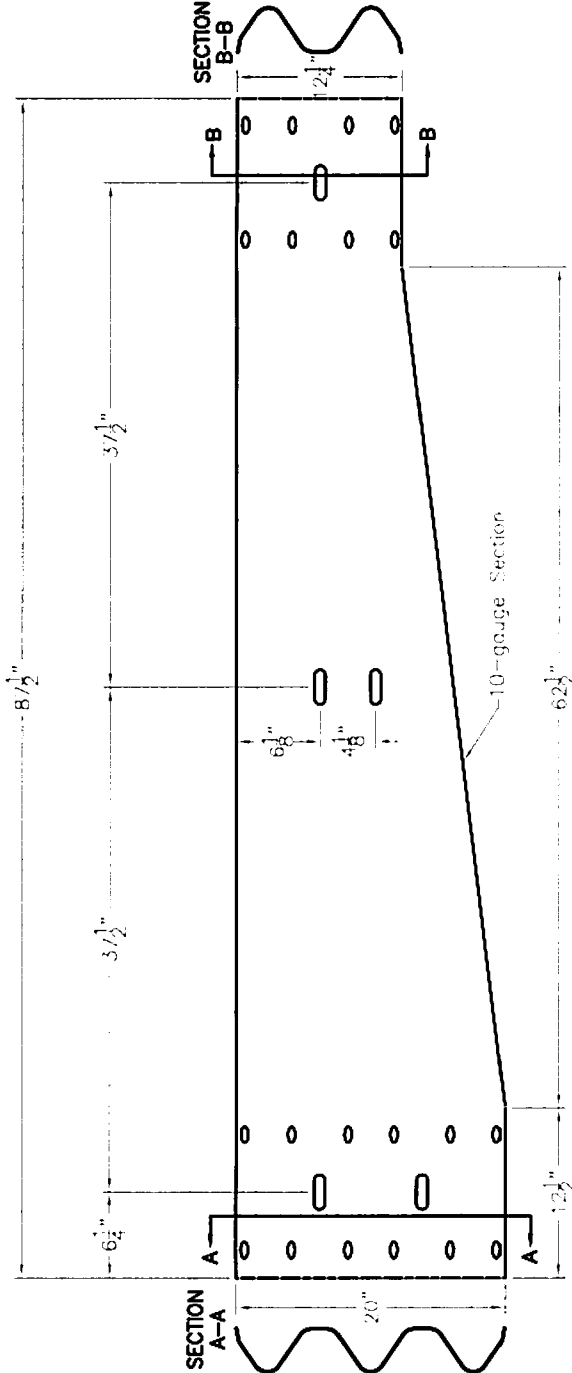

	<b>W-BEAM TO STIFF BRIDGE TRANSITION LAYOUT AND DESIGN DETAILS</b>		Sheet: 2 of 13 Date: 08/24/2007 By: GJEP Rev: EMA
	Drawing Name: MWT-5 R8.dwg	Scale: None	



 <b>Midwest Roadside Safety Facility</b>	<b>W-BEAM TO STIFF BRIDGE TRANSITION</b>		Sheet: 3 of 13
	Asymmetrical W-Beam to Thick Beam Transition Rail Detail		Date: 08/24/2007
Drawing Name: MWT-5 R8.dwg		Scale: 1"=10'	By: GEP
			Rev: EMA

Sheet	4 of 13	<b>W-BEAM TO STIFF BRIDGE TRANSITION</b> <b>CAP RAIL DETAIL &amp; POST 18</b>	Drawing Name <b>MW-T-5 R.R.dwg</b>	Scale None	Rev EMA
Date	08/24/2007				
<b>Midwest Roadside Safety Facility</b>					

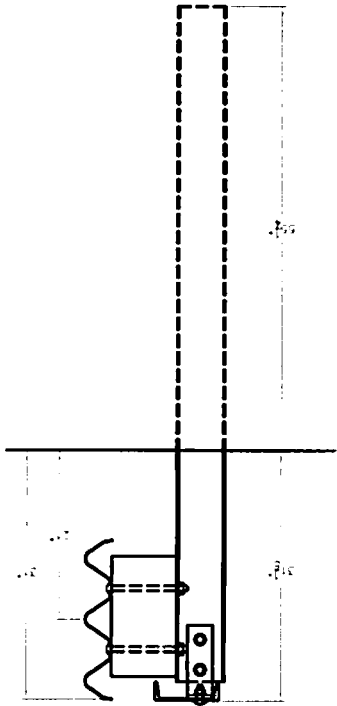

THREE BEAM BLOCKOUT THREE BEAM SUPPORT DETAILS

NOTES:  
 (1) Detail for wide-flange  
 and channel ASTM A588  
 and A572 Gr 50 or  
 (2) All holes are 1/8" diameter  
 (3) All bolts are F1554  
 diameter

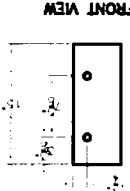

FRONT VIEW

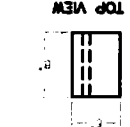

TOP VIEW

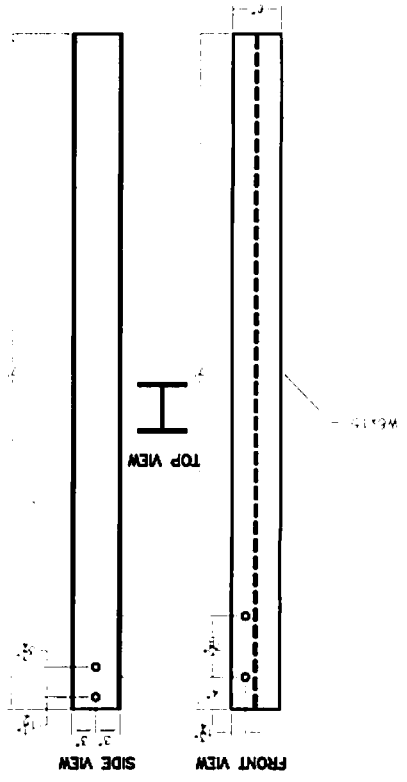

THREE BEAM POST (Post No. 18)

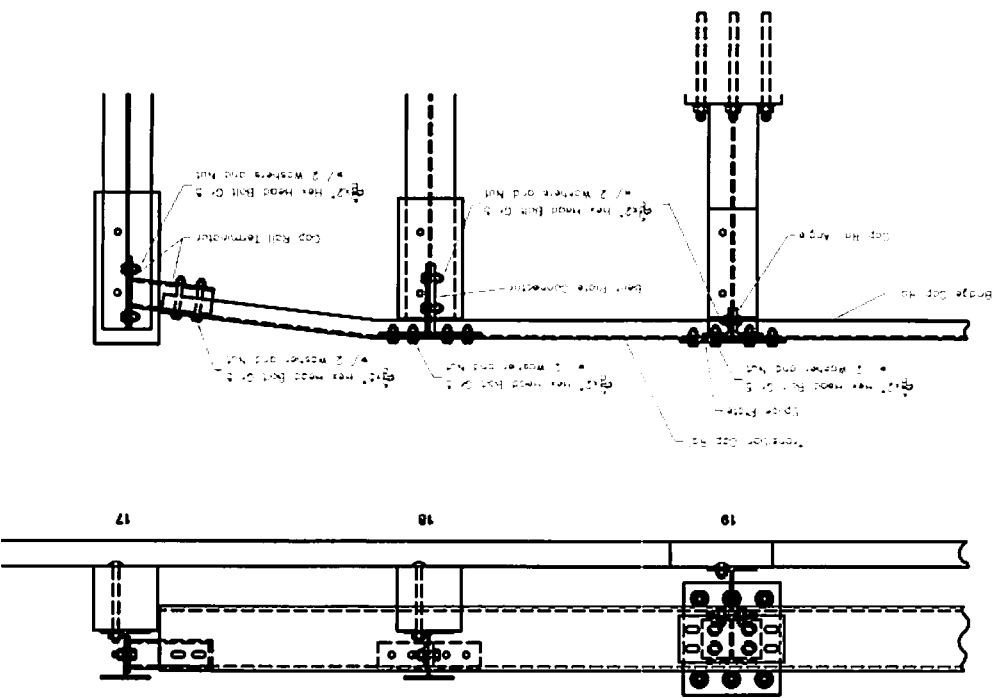

17

18

19

Rev: EMA	Scale: None	Drawng Name: MW1-5 R8.dwg	Midwest Roadside Safety Facility
By: GEP	POST 16 & 17		
Date: 08/24/2007	W-BEAM TO STIFF BRIDGE TRANSITION		
Sheet: 5 of 13			

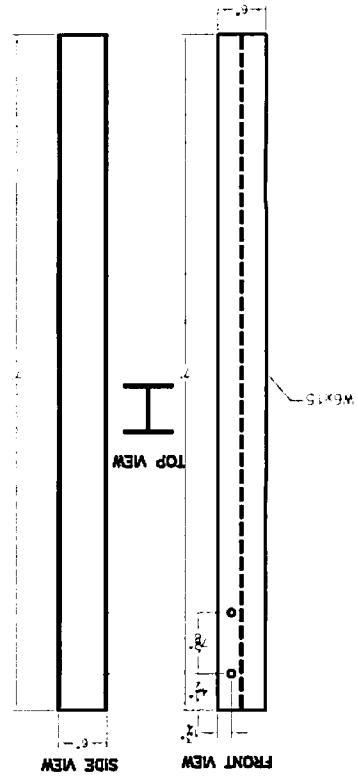

THREE BEAM POST  
(Post No. 16)

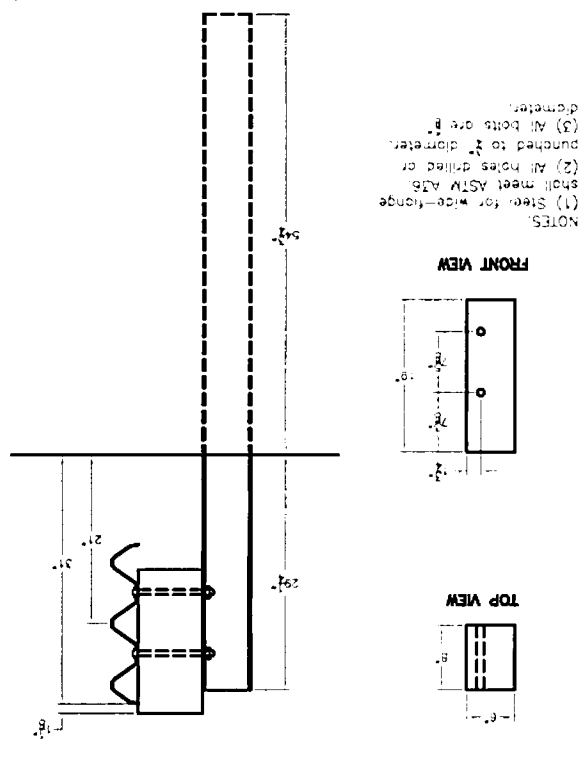

THREE BEAM BLOCKOUT THREE BEAM SUPPORT DETAILS

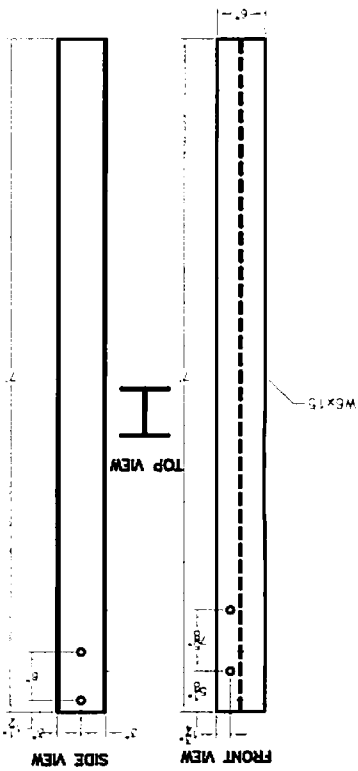

THREE BEAM POST  
(Post No. 17)

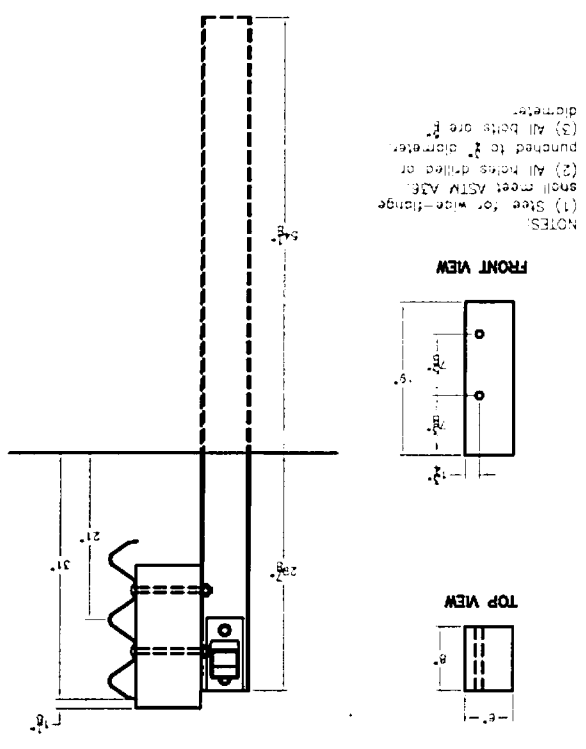

THREE BEAM BLOCKOUT THREE BEAM SUPPORT DETAILS

NOTES:  
 (1) Steel for wide-flange shall meet ASTM A36.  
 (2) All holes drilled or punched to 3/4" diameter.  
 (3) All bolts are 1/2" diameter.

NOTES:  
 (1) Steel for wide-flange shall meet ASTM A36.  
 (2) All holes drilled or punched to 3/4" diameter.  
 (3) All bolts are 1/2" diameter.



Rev: EMA	Scale: None	Drawing Name: MWT-5 R8.dwg	<b>Midwest Roadside Safety Facility</b> 
By: GEP	<b>W-BEAM TO STIFF BRIDGE TRANSITION</b> <b>POST 12</b> <b>POST 13-15 &amp;</b>		
Date: 08/24/2007			
Sheet: 6 of 13			

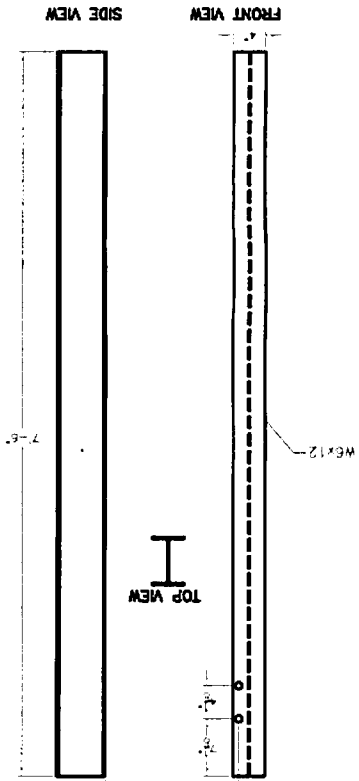

**W-BEAM TO THREE BEAM MID-POST (Post No. 12)**

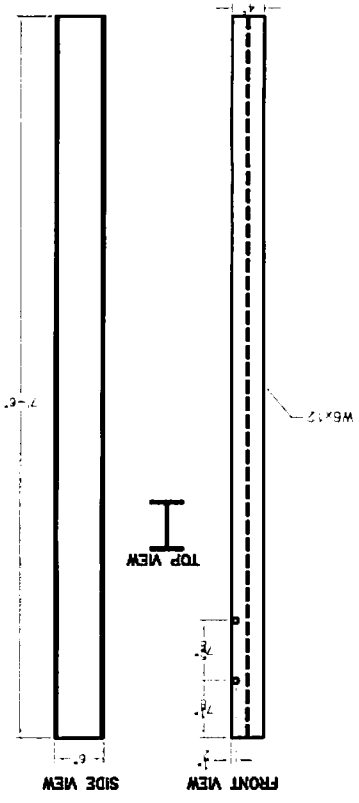

**THREE BEAM POST (Post No. 13-15)**

NOTES:  
 (1) Steel for wide-flange shall meet ASTM A36.  
 (2) All holes drilled or punched to 1/2" diameter.  
 (3) All bolts are 1/2" diameter.

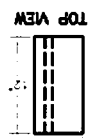
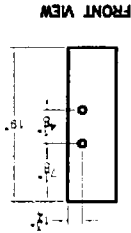

**W-BEAM TO THREE BEAM MID-POST BLOCKOUT**

NOTES:  
 (1) Steel for wide-flange shall meet ASTM A36.  
 (2) All holes drilled or punched to 1/2" diameter.  
 (3) All bolts are 1/2" diameter.

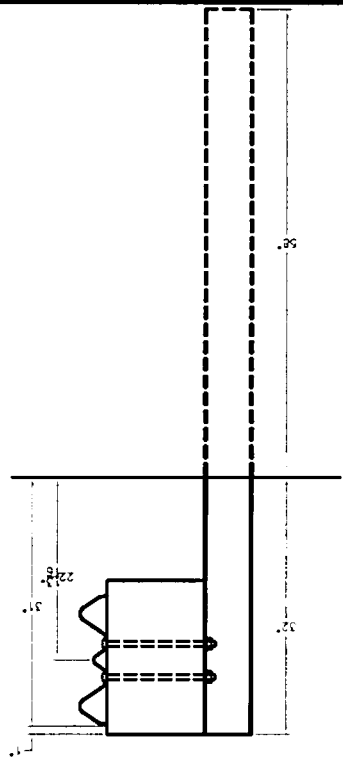
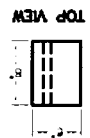
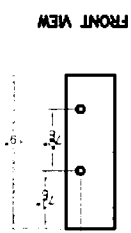

**W-BEAM TO THREE BEAM SUPPORT DETAILS**

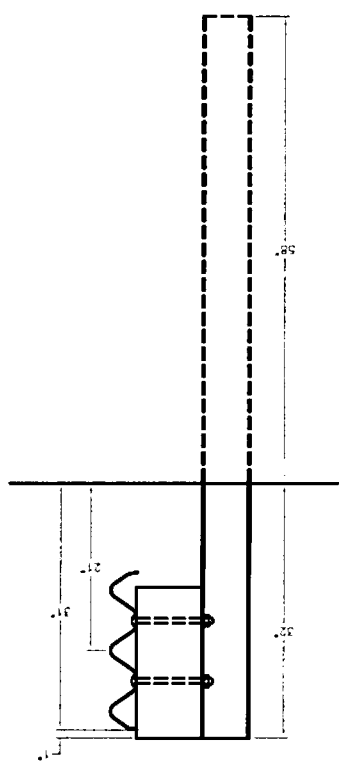

**THREE BEAM BLOCKOUT THREE BEAM SUPPORT DETAILS**

Rev: EMA	Scale: None	Drawing Name: MW-T-5 R8.dwg	Midwest Roadside Safety Facility
By: GEP	POST 9-11 & POST 3-8		
Date: 08/24/2007	W-BEAM TO STIFF BRIDGE TRANSITION		
Sheet: 7 of 13			

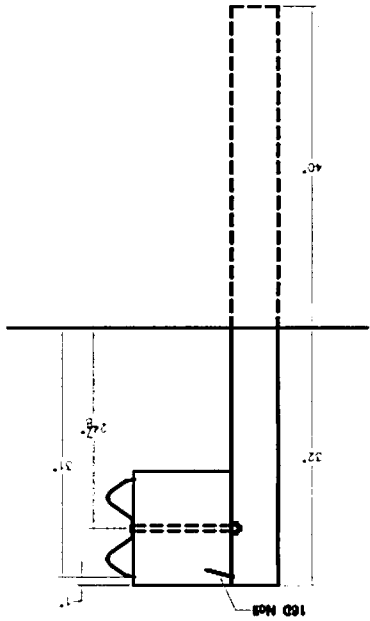

W-BEAM SUPPORT DETAILS

NOTES:  
 (1) Steel for wide-flange shall meet ASTM A36.  
 (2) All holes drilled or punched to 1/2" diameter.  
 (3) All bolts are 1/2" diameter.

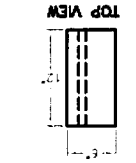
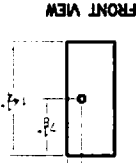

W-BEAM BLOCKOUT

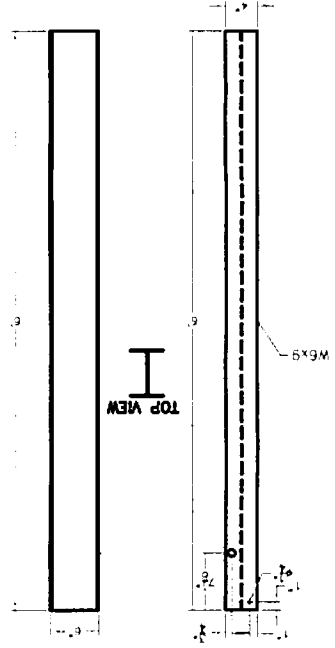

W-BEAM POST (Post No. 3-8)

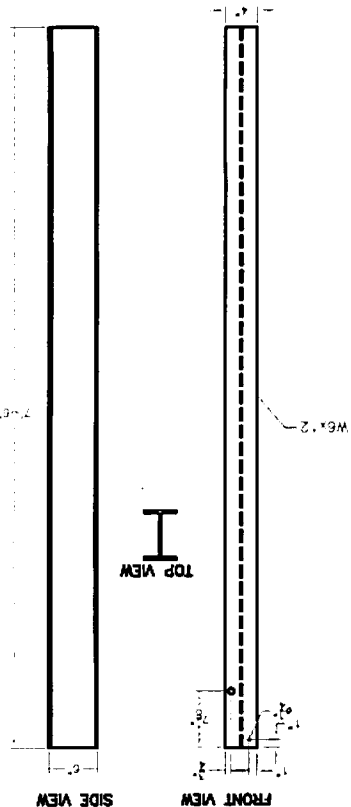

W-BEAM POST (Post No. 9-11)

NOTES:  
 (1) Steel for wide-flange shall meet ASTM A36.  
 (2) All holes drilled or punched to 1/2" diameter.  
 (3) All bolts are 1/2" diameter.

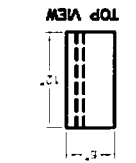
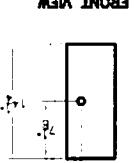

W-BEAM BLOCKOUT

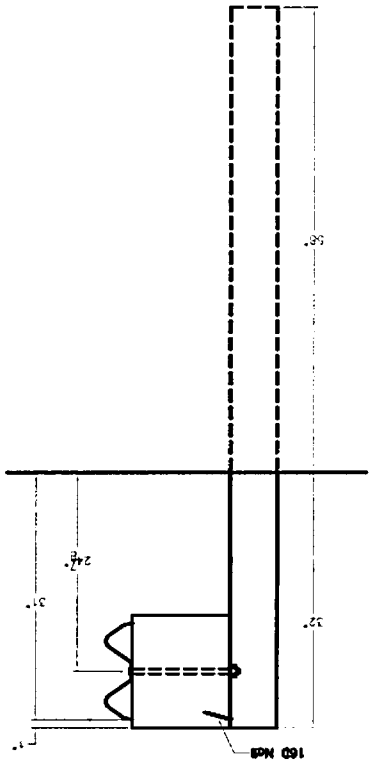

W-BEAM SUPPORT DETAILS



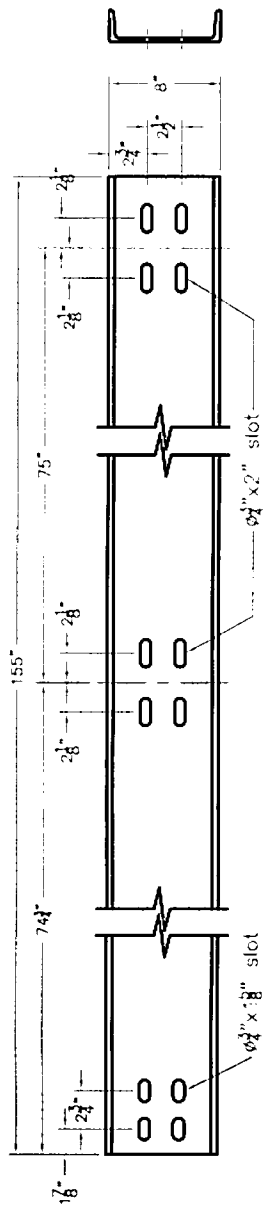

Bridge Cap Rail  
CBx11.5

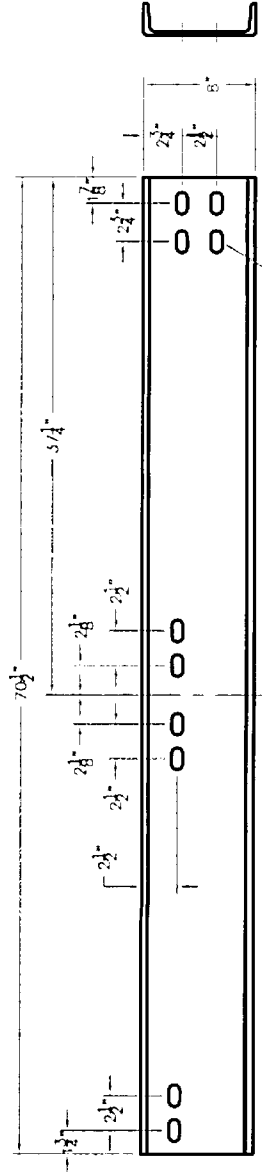

Transition Cap Rail  
CBx11.5

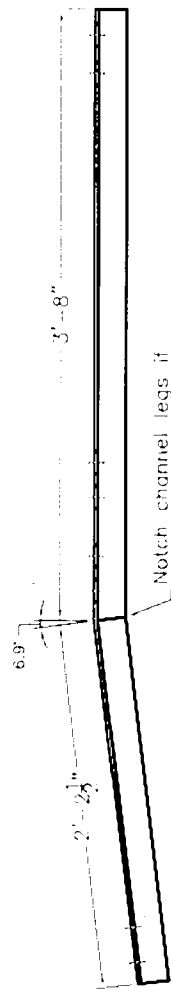

Bent Plate Connector  
L 6 1/2" x 9" x 3/8"

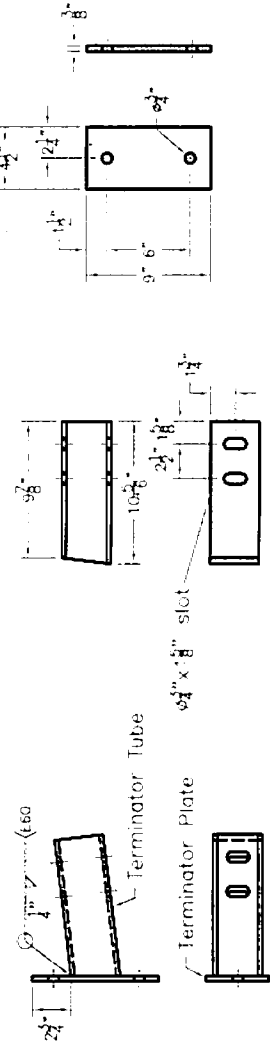

Terminator Assembly

Terminator Tube  
TS 3 1/2" x 5 1/2" x 4"

Terminator Plate  
9" x 4 1/2" x 3/8"

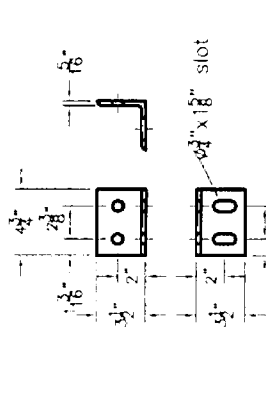

Cap Rail Angle  
L 3 1/2" x 3 1/2" x 1/8"

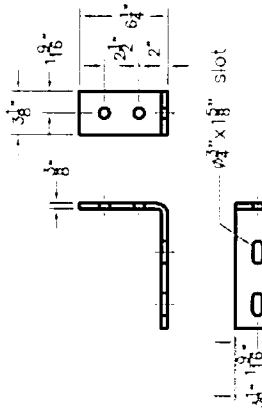

Bent Plate Connector  
L 6 1/2" x 9" x 3/8"

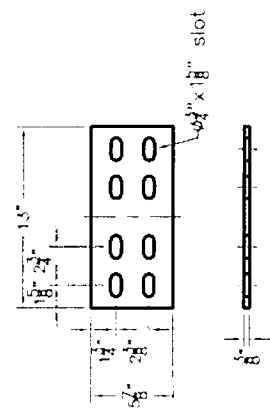

Splice Plate  
5 1/2" x 13" x 3/8"

	<b>W-BEAM TO STIFF BRIDGE TRANSITION</b>		Sheet: 9 of 13
	<b>CHANNEL BRIDGE RAIL DESIGN DETAILS (CONT'D)</b>		Date: 08/24/2007
Drawing Name: MWT-5 R8.dwg		By: GEP	Rev: EMA
Scale: None			

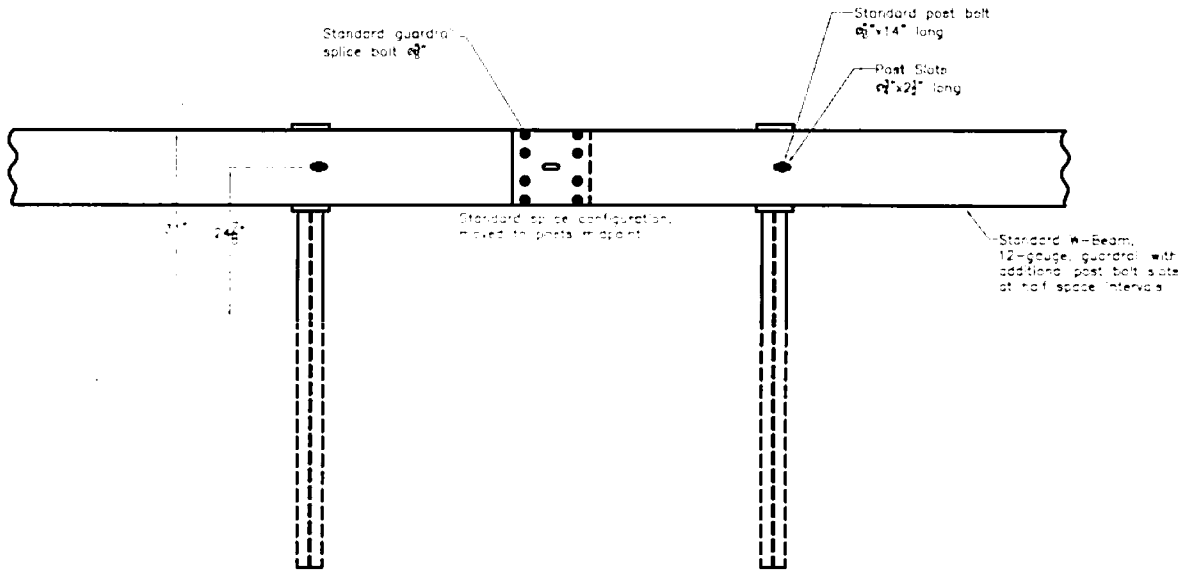

**SPLICE DETAIL**

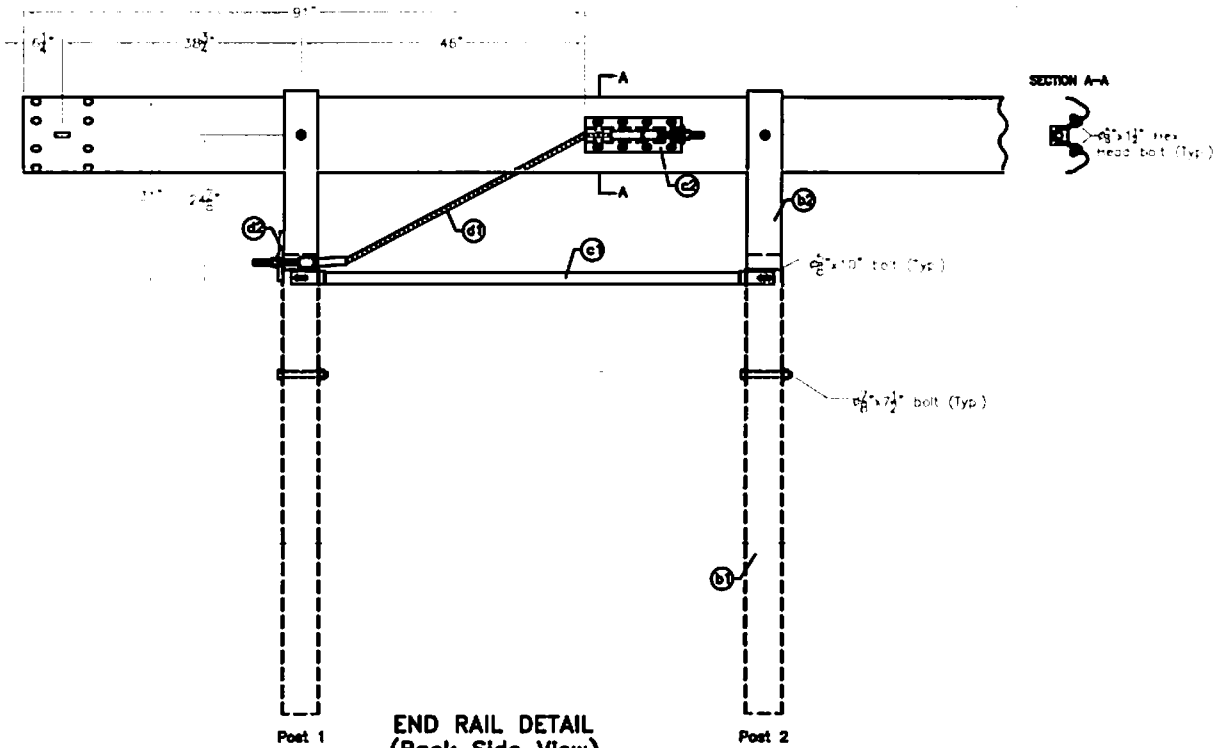

**END RAIL DETAIL  
(Back Side View)**

	<b>W-BEAM TO STIFF BRIDGE TRANSITION</b>		Sheet 10 of 13
	<b>Rail Detail End BCT Detail</b>		Date 08/24/2007
<b>Midwest Roadside Safety Facility</b>	Drawing Name MWT-5 R8.dwg	Scale 1=30	By GEP
			Rev EMA

ITEM	QTY	DESCRIPTION	MATERIAL
b1	2	Foundation Tubes	PIE05
b2	2	BCT Timber Post	PDF01

**MGS BCT TIMBER POST  
(Part b2)**

TOP VIEW

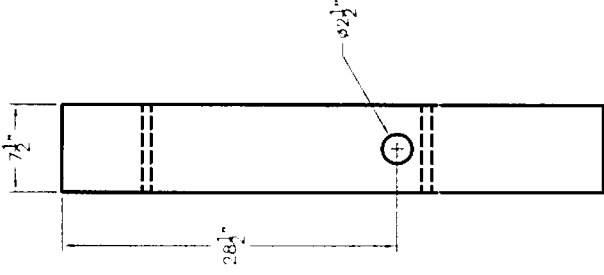

FRONT VIEW

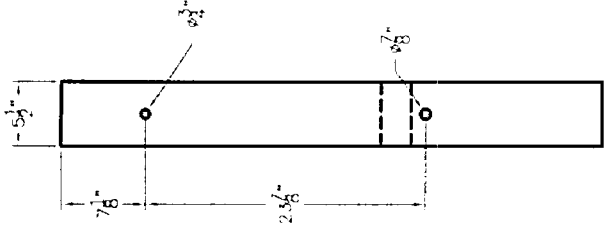

FRONT VIEW

**MGS FOUNDATION TUBE  
(Part b1)**

TOP VIEW

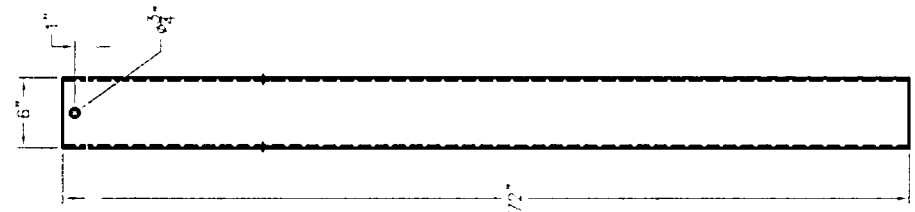
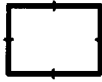

FRONT VIEW

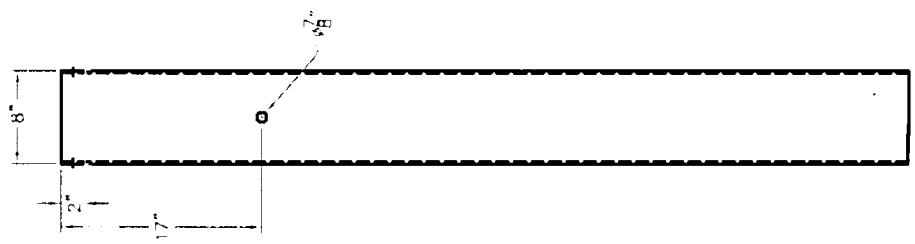

SIDE VIEW

	<b>W-BEAM TO STIFF BRIDGE TRANSITION</b>	Sheet: 11 of 13
	<b>BCT POST &amp; TUBE DETAIL</b>	Date: 08/24/2007
Drawing Name: MWT-5 R8.dwg	Scale: 1=16	By: GEP
<b>Midwest Roadside Safety Facility</b>		Rev: EMA

ITEM	QTY	DESCRIPTION	MATERIAL
c1	2	Cable Strut	PEP01
c2	2	Anchor Bracket	FPA01

Yoke Details

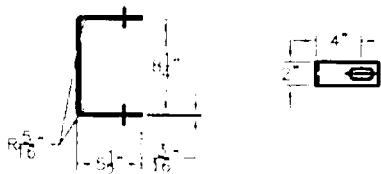

Strut Details

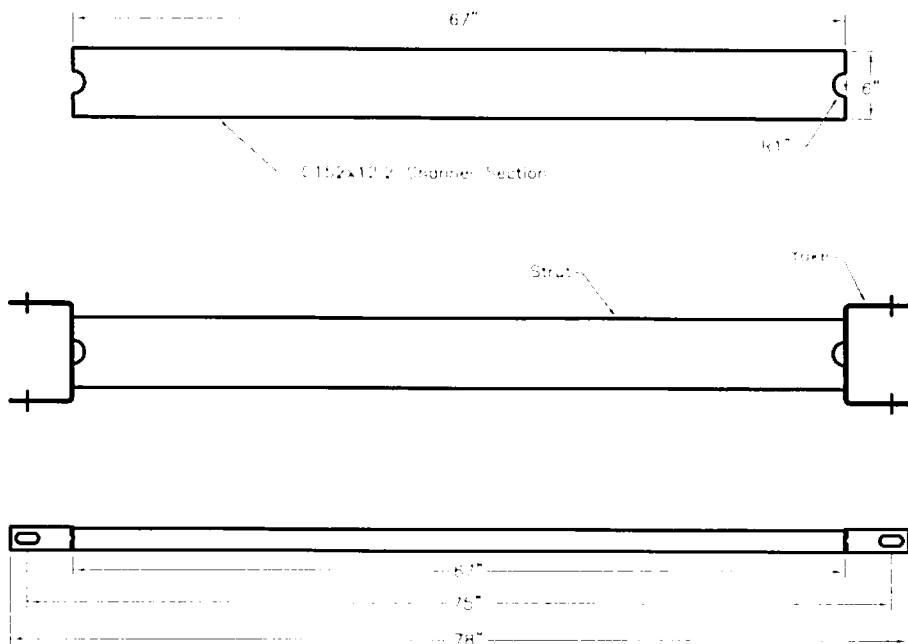

Cable Strut  
(Part c1)

Anchor Bracket  
(Part c2)

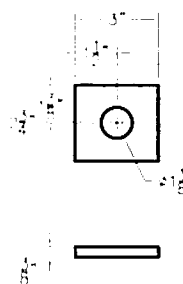
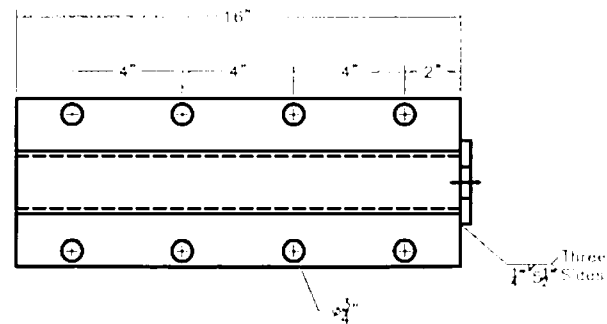

End Plate

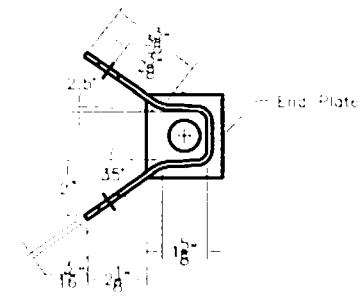

End View



Midwest Roadside  
Safety Facility

W-BEAM TO  
STIFF BRIDGE TRANSITION

CABLE STRUT &  
ANCHOR BRACKET

Drawing Name  
MWT-5 R8.dwg

Scale:  
None

Sheet:  
12 of 13  
Date:  
08/24/2007  
By:  
GEP  
Rev:  
EMA

ITEM QTY	DESCRIPTION	MATERIAL
d1 2	Anchor Cable	FCA01
a2 2	Bearing Plate	FPB01

### Anchor Cable (Part d1)

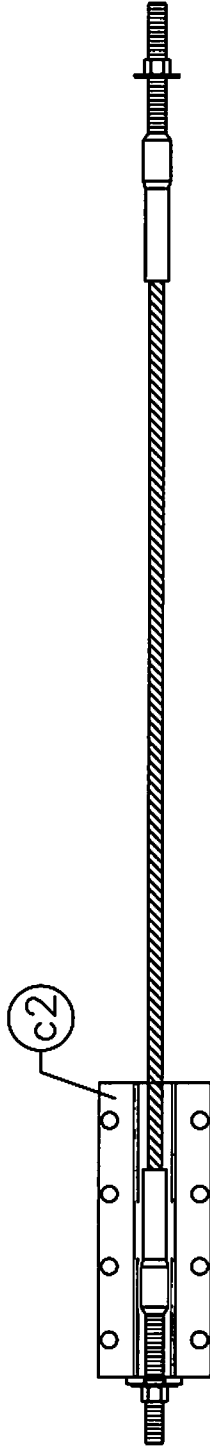
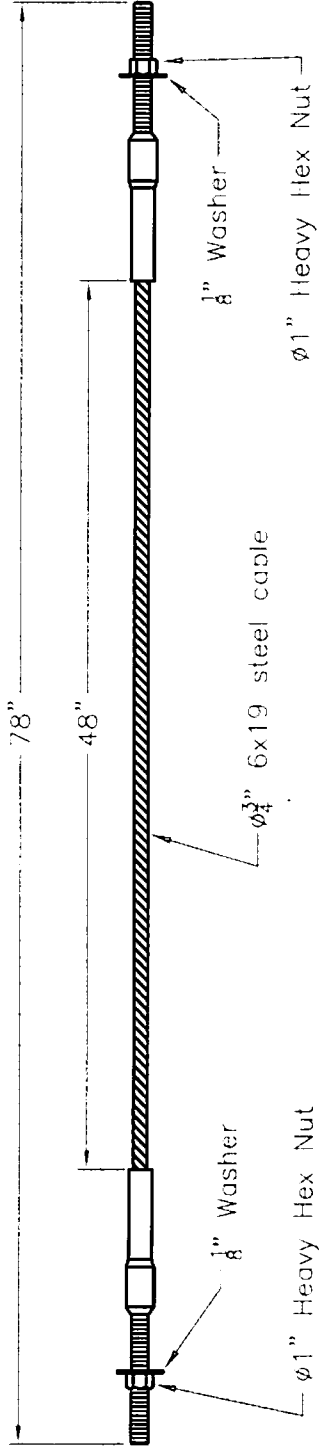

### Bearing Plate (Part d2)

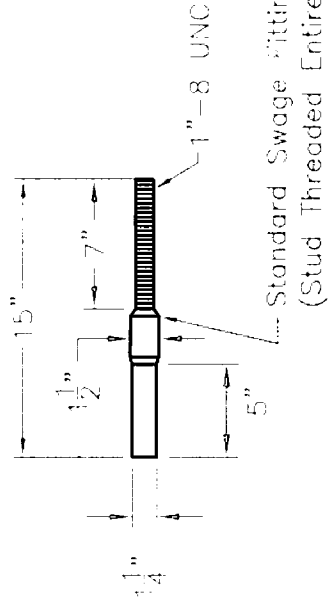
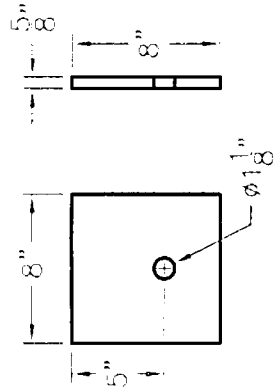

	<b>W-BEAM TO STIFF BRIDGE TRANSITION</b>	Sheet: 13 of 13
	<b>ANCHOR CABLE DETAILS</b>	Date: 08/24/2007
Drawing Name: MWT-5 R8.dwg	Scale: 1=10	By: GEP Rev: EMA