



U.S. Department
of Transportation
Federal Highway
Administration

400 Seventh St., S.W.
Washington, DC 20590

March 21, 2007

Archived

In Reply Refer To:
HSSD/B-156

For

Mr. Andrew Artar
Vice President Sales and Marketing
Gregory Industries, Inc.
4100 13th Street, SW
Canton, OH 44170

Research

Dear Mr. Artar:

In your letter of December 13, 2006, you requested the Federal Highway Administration's (FHWA) acceptance of Single-Sided and Double Sided Thrie-Beam called the GMS-TB Guardrail System at the National Cooperative Highway Research Program (NCHRP) Report 350 test level 3 (TL-3). To support your request, your company sent a copy of the Southwest Research Institute report dated November 30, 2006, entitled "NCHRP Report 350 Test 4-11 Full-Scale Crash Evaluation of a Single-face GMS-TB Guardrail System" and digital videos of the crash test conducted on the GMS-TB Guardrail System. You also requested the waiver of tests 3-10 of the Single-Sided and Double Sided GMS-TB Guardrail System and test 3-11 of the Double-Sided GMS-TB Guardrail System.

Requirements

Longitudinal barriers should meet the guidelines contained in the NCHRP Report 350, "Recommended Procedures for the Safety Performance Evaluation of Highway Features." The FHWA Memorandum "**ACTION: Identifying Acceptable Highway Safety Features**" of July 25, 1997, provides further guidance on crash testing requirements.

Product description

The GMS-TB Guardrail System is a Thrie-Beam longitudinal barrier which uses 12-gage Thrie-Beams mounted directly on conventional W6 x 8.5 posts without blockouts or backup plates at any of the posts. The Thrie-Beams are attached to the posts with a single proprietary Mini Spacer (GMS) fastener at each post, with the fastener being attached to the Thrie-Beam at the lower flange of the Thrie-Beam (using a 0.64 m (25 in.) mounting height). All guardrail splices are located at posts. The guardrail panels are each 3.81 m (12.5 ft) long, the posts are spaced at 1.91 m (6.25 ft), and the height of the top of the guardrail is 0.99 m (39 in). This height constitutes an increase of approximately 100mm (4 in) compared to the conventional

**MOVING THE
AMERICAN
ECONOMY**

Only

SGR09 (a,b,c) Thrie-Beam systems and accounts for higher centers of gravity of the current vehicle fleet. The ground clearance of the system is 483 mm (19 in), which is the same ground clearance that was used in the W-beam GMS designs previously accepted by the FHWA (acceptance letter HSA-10/B150). The proprietary GMS fastener is a critical element of the system. It ensures that Thrie-Beam panels disengage from the posts on impact and are not pulled down to the ground and rotated by the posts. Such performance lowers the probability of vehicles overriding the system. Also, posts disengaged from the guardrail have less of a snagging potential compared to posts attached to the guardrail. Design details for the proprietary GMS fastener are shown in Enclosure 1.

Test article installation

The test article's length-of-need section was 45.72 m (150 ft) long. The 12 guardrail panels between the end anchors were each 3.81 m (12.5 ft) long, the posts were spaced at 1.91 m (6.25 ft), and the height of the top of the guardrail was 0.99 m (39 in). The barrier system was terminated at either end with modified Type T Anchors (Foundation Tube Option), without blockouts, and without struts between posts. This end anchor is designed to span three posts. However, rectangular washers were added at posts 1 through 4 and 28 through 31 for purposes of this length-of-need test only. Drawings of the test article are presented in Enclosure 1. Note that the end anchor systems were assembled as shown, except that Thrie-Beam rails were used in place of the W-Beam rails and the anchor cable bracket was attached to the lower flange of the Thrie-Beam rail.

Including the extended end anchors, the entire longitudinal barrier spanned 31 posts, with the length-of-need section mounted from post 4 through post 28. The total length of the longitudinal barrier in the test installation, including the end anchors, was 57.15 m (187.5 ft).

Testing

Full-scale crash testing to evaluate the impact performance of the GMS-TB Guardrail System included test 3-11. The results of this test are summarized in Enclosure 2. A comparison of the test results with the evaluation criteria set forth in the NCHRP Report 350 indicates compliance with all recommended criteria for the test performed.

The GMS-TB Guardrail System performed as intended. In the posts that were directly contacted by the test vehicle (Posts 13 through 19), the guardrail was released from the posts. In the vehicle contact region, all of the fasteners were sheared at the front face of the post during the impact of the vehicle with the guardrail and posts, except for Post 16 where the fastener was not sheared. All of these fasteners exhibited a uniform U-shaped deformation of the release washers. Outside of the vehicle contact region, the fasteners in Posts 20 through 24 released from the guardrail without being sheared, and in Post 25 the fastener released from the guardrail and was sheared at the front face of the post. These fasteners also exhibited a uniform U-shaped deformation of the release washers. None of the Thrie-Beams failed and all of the splice joints remained fastened together. The guardrail was not smashed flat at any of the posts in the impact region and for the most part maintained its Thrie-Beam shape.

Previously, you successfully conducted test 3-10 on a Double-Sided (median) GMS W-beam barrier (FHWA acceptance letter HSA-10/B-150). I agree that this previously conducted test is comparable to test 3-10 on either Single-Sided or Double Sided GMS-TB Guardrail Systems. It is critical that the ground clearance and mounting height of the GMS-TB Guardrail Systems are the same as those used in the 3-10 test conducted on the GMS W-beam design accepted by the FHWA. Therefore, I agree that test 3-10 on Single-Sided or Double Sided GMS-TB Guardrail Systems can be waived.

Further, test 3-11 on Double Sided GMS-TB Guardrail Systems would be less severe than test 3-11 conducted on Single-Sided GMS-TB Guardrail System. Therefore, I agree that test 3-11 on Double Sided GMS-TB Guardrail Systems can be waived.

In summary, I agree that both Single-Sided and Double Sided GMS-TB Guardrail Systems, as described above, meet the appropriate evaluation criteria for NCHRP 350 TL-3 devices and may be used at all appropriate locations on the National Highway System (NHS) when selected by the contracting authority, subject to the provisions of Title 23, Code of Federal Regulations, Section 635.411, as they pertain to proprietary products.

Standard provisions

Please note the following standard provisions that apply to the FHWA letters of acceptance:

- Our acceptance is limited to the crashworthiness characteristics of the devices.
- Any changes that may adversely influence the crashworthiness of the device will require a new acceptance letter.
- Should the FHWA discover that the qualification testing was flawed, that in-service performance reveals unacceptable safety problems, or that the device being marketed is significantly different from the version that was crash tested, it reserves the right to modify or revoke its acceptance.
- You will be expected to supply potential users with sufficient information on design and installation requirements to ensure proper performance.
- You will be expected to certify to potential users that the hardware furnished has essentially the same chemistry, mechanical properties, and geometry as that submitted for acceptance, and that they will meet the crashworthiness requirements of the FHWA and the NCHRP Report 350.
- To prevent misunderstanding by others, this letter of acceptance, designated as number B-156, shall not be reproduced except in full. As this letter and the documentation which support it become public information, it will be available for inspection at our office by interested parties.
- The GMS-TB Guardrail System is a patented product and is considered "proprietary". The use of proprietary devices specified on Federal-aid projects, except exempt, non-NHS projects must be: (a) supplied through competitive bidding with equally suitable unpatented items; (b) certified by the highway agency as essential for synchronization with existing highway facilities, or that no equally suitable alternative exists; or (c) used for research or for a distinctive type of construction on relatively short sections of road for experimental

purposes. Our regulations concerning proprietary products are contained in Title 23, Code of Federal Regulations, Section 635.411, a copy of which is enclosed.

Sincerely yours,



John R. Baxter, P.E.
Director, Office of Safety Design
Office of Safety

2 Enclosures

Archived -
For
Research
and
Historical
Purposes
Only

Archived -

GREGORY MINI SPACER

DESCRIPTION	LENGTH	MATERIAL
5/16 BOLT	1-3/4"min	A307
5/16 GMS CONICAL WASHER		F844
5/16 X 1-1/4 O.D. RELEASE WASHER (2)		F844
5/16 X 1-1/4 O.D. BENT WASHER		F844
5/16 X 1-1/4 O.D. POST WASHER		F844
5/16 HVY HX NUT		A563 GR A
ALTERNATE SOLID NUT		A563 GR A

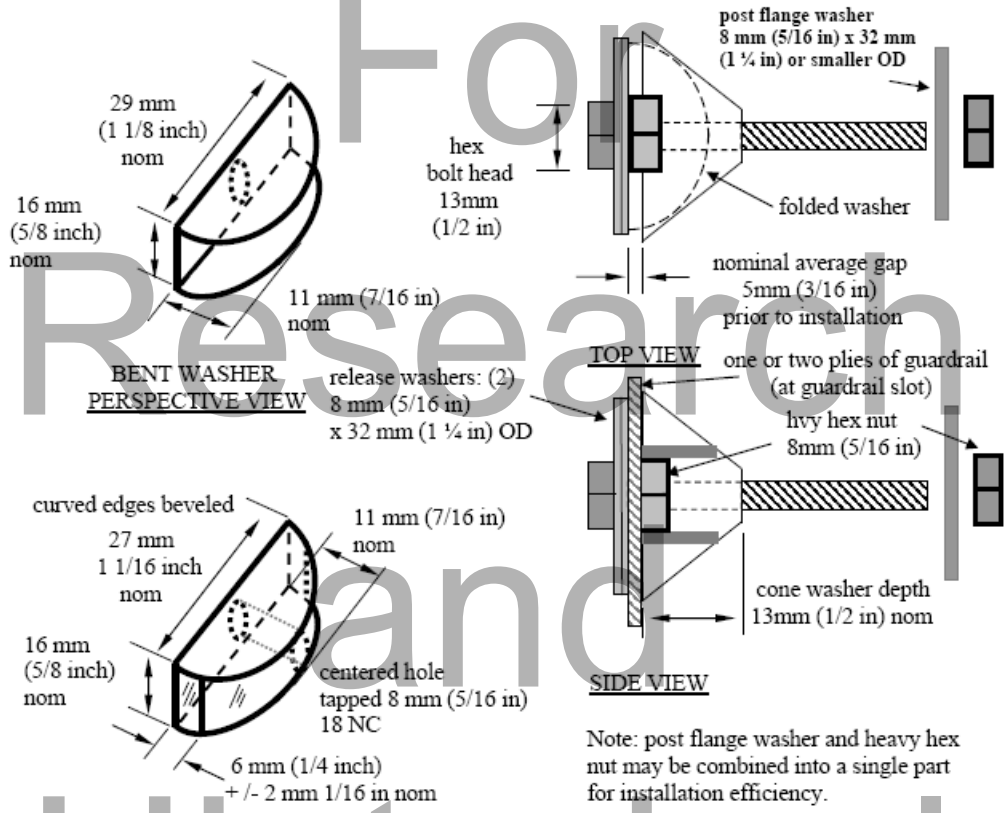

Historical

Purposes

Only

Archived -
For
Research
and
Historical
Purposes
Only

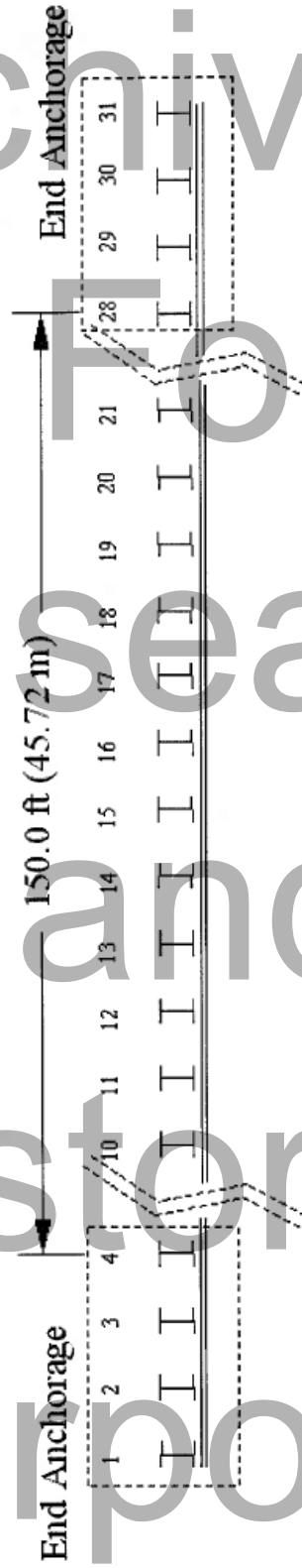

Figure A.1 – Gregory Industries Single-Face GMS-TB Guardrail System

NOTES

APPLICATION: Use Type T Anchor Assemblies on the trailing end of guardrail runs, located outside of the clear zone of opposing traffic. The assembly is 16'-3.81' long, which can be considered the length of need for the guardrail run.
 For termination requirements at driveways, see **DRIVEWAY OPENING** Detail on Sheet 2. For side road approaches and terminals of Structures, see **Location & Design Manual, Volume 1, Figures 603-3, 603-4, and 603-5.**

ANCHORING OPTIONS: Contractor may choose either the Foundation Tube (shown on this Sheet) or the concrete footing option (Sheet 2) to construct this anchor assembly.
 If the foundation tube option is chosen, the contractor will take proper care to insure that the Soil Plate fasteners are not broken during the driving process.
 Concrete footings may be cast-in-place or precast. Compact will offer placing precast units.

MATERIALS: See **SCD 6R-1J** for parts used on this anchor, including the CRT Breakaway Posts, Steel Ground Tube, Post Sleeve, Cable Anchor and Bracket Assembly.
 Bearing Plate and Soil Plate is ASTM A709 Grade 35 Steel
 Ground Tube shall be ASTM A500, Grade B, and meet CMS 707.10.
 All angles, channels and plates shall meet CMS 710.0. All bolt steel shall be galvanized as specified in CMS 711.02. All bolt washers indicated are standard galvanized steel of the appropriate size.
 Concrete shall be class C.

Components of this anchor that are not detailed on **SCD 6R-1J** include: 1) 12'-6" (3.81 m) W-Beam Terminal Rail (standard part RW144), and 2) W-Beam Rounded End Section (RWED30). For complete details and specifications, see part descriptions in the **AASHTO/AACR/ARTBA Standardized Hardware Guide**.
 See **SCD 6R-2J** for Type 5 Guardrail Details.
POSTS: Post No. 2 can be W6x9 (W160x13.9) or W6x8.5 (W150x12.9) with notched wood blockouts.
 Use of alternate posts or recycled plastic blockouts is not permitted.
PAYMENT: All labor and materials, including the W-Beam Rounded End Section and the W-Beam Terminal Rail for the 12'-6" (3.81 m) anchor assembly shall be included in the unit price bid for Item 805 - Anchor Assembly, Type T, Each.

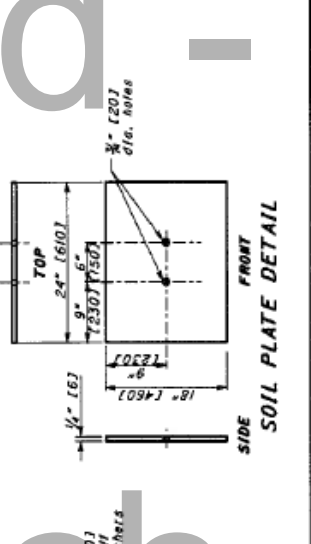
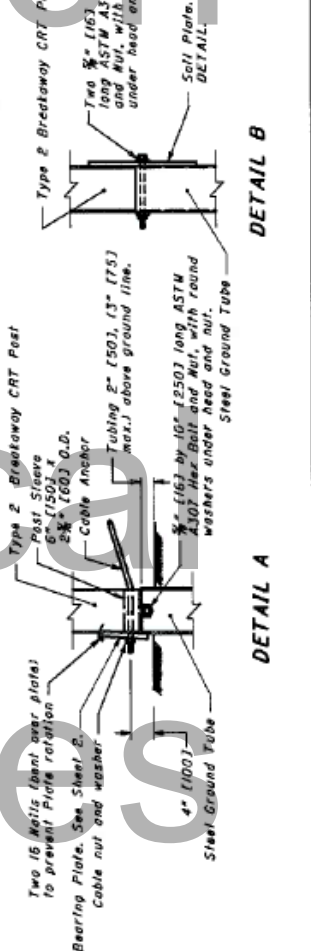
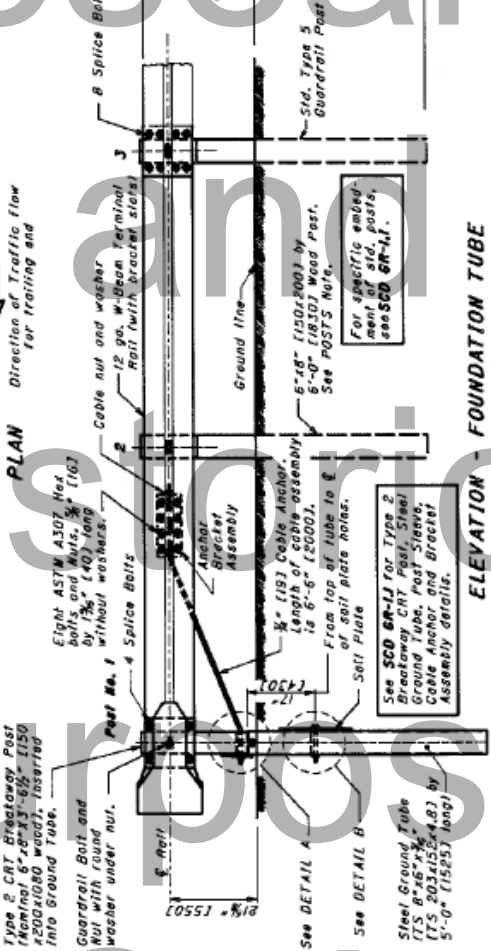
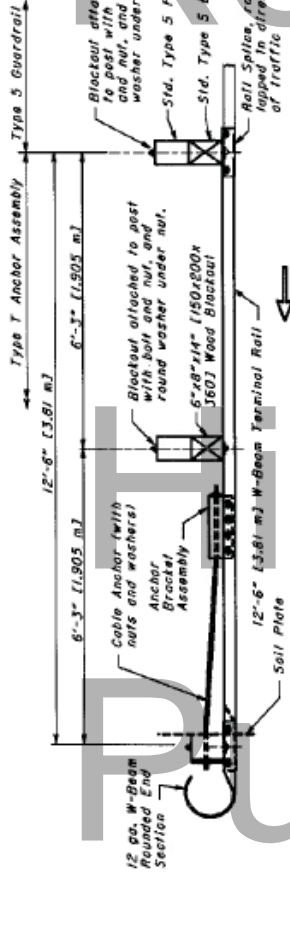

Summary of Test Results and Conditions

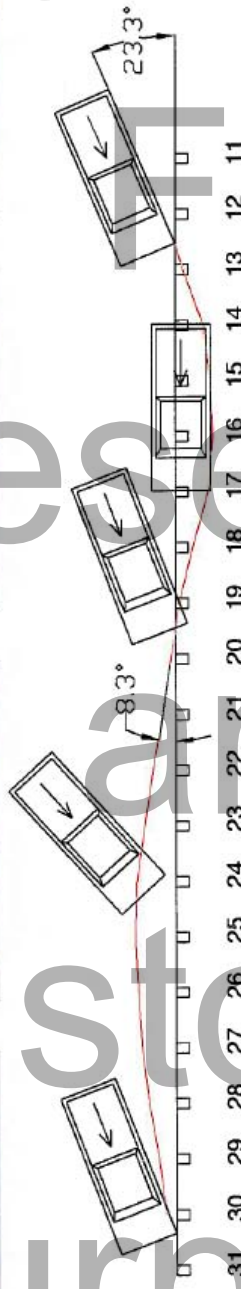

General Information	
Test Agency.....	Southwest Research Institute
Test Number.....	GMS-3
Test Date.....	11/09/2006
Test Category.....	4-11
Test Article	
Type.....	Longitudinal Barrier
Installation Length.....	57.15 m (187.5 ft)
Nom. Barrier Height.....	991 mm (39 in)
Type of Primary Barrier...	Modified G4-1S Longitudinal Barrier
Soil	Stable, Moist - "Standard" Soil
Test Vehicle	
Type.....	½ Ton Quad Cab Pickup
Designation.....	2270P
Model.....	2002 Dodge Ram 1500 Quad Cab
Mass (kg).....	2197
Inertial Mass (kg).....	2197
Dummy Mass (kg).....	NA
Gross Static Mass (kg)....	2197
Impact Conditions	
Speed (km/hr).....	105.7
Angle (degrees).....	23.3
Exit Conditions	
Speed (km/hr).....	51 (calculated)
Angle (degrees).....	8.3
Occupant Risk Values	
Impact Velocity (m/s)	
x-direction.....	5.2
y-direction.....	4.0
Ridedown Accelerations (g's)	
x-direction.....	12.9
y-direction.....	10.4
Post Impact Vehicular Behavior (limited to events <1.000 seconds)	
Maximum Roll Angle (degrees).....	8.6 @ 0.723 sec.
Maximum Pitch Angle (degrees).....	4.2 @ 0.804 sec.
Maximum Yaw Angle (degrees).....	28.8 @ 0.384 sec.
Test Article Deflection	
Dynamic.....	1.3 m (4.3 ft)
Permanent.....	0.86 m (2.8 ft)
Vehicle Damage	
Exterior	
CDC.....	J1LFEW5
VDS.....	J1-LFQ-3
Interior	
OCDI.....	LF0000000
Max. Deform. (mm).....	0

**Title 23, Code of Federal Regulations,
§ 635.411 Material or product selection.**

(a) Federal funds shall not participate, directly or indirectly, in payment for any premium or royalty on any patented or proprietary material, specification, or process specifically set forth in the plans and specifications for a project, unless:

(1) Such patented or proprietary item is purchased or obtained through competitive bidding with equally suitable unpatented items; or

(2) The State transportation department certifies either that such patented or proprietary item is essential for synchronization with existing highway facilities, or that no equally suitable alternate exists; or

(3) Such patented or proprietary item is used for research or for a distinctive type of construction on relatively short sections of road for experimental purposes.

(b) When there is available for purchase more than one nonpatented, nonproprietary material, semifinished or finished article or product that will fulfill the requirements for an item of work of a project and these available materials or products are judged to be of satisfactory quality and equally acceptable on the basis of engineering analysis and the anticipated prices for the related item(s) of work are estimated to be approximately the same, the PS&E for the project shall either contain or include by reference the specifications for each such material or product that is considered acceptable for incorporation in the work. If the State transportation department wishes to substitute some other acceptable material or product for the material or product designated by the successful bidder or bid as the lowest alternate, and such substitution results in an increase in costs, there will not be Federal-aid participation in any increase in costs.

(c) A State transportation department may require a specific material or product when there are other acceptable materials and products, when such specific choice is approved by the Division Administrator as being in the public interest. When the Division Administrator's approval is not obtained, the item will be nonparticipating unless bidding procedures are used that establish the unit price of each acceptable alternative. In this case Federal-aid participation will be based on the lowest price so established.

(d) Appendix A sets forth the FHWA requirements regarding (1) the specification of alternative types of culvert pipes, and (2) the number and types of such alternatives which must be set forth in the specifications for various types of drainage installations.

(e) Reference in specifications and on plans to single trade name materials will not be approved on Federal-aid contracts.

(f) In the case of a design-build project, the following requirements apply: Federal funds shall not participate, directly or indirectly, in payment for any premium or royalty on any patented or proprietary material, specification, or process specifically set forth in the Request for Proposals document unless the conditions of paragraph (a) of this section are applicable.

[41 FR 36204, Aug. 27, 1976, as amended at 67 FR 75926, Dec. 10, 2002]