

---

# UNSTABLE SLOPE MANAGEMENT PROGRAM FOR FEDERAL LAND MANAGEMENT AGENCIES

---

Publication No. FHWA-FLH-19-002

January 2019

---



U.S. Department  
of Transportation  
**Federal Highway  
Administration**

## FOREWORD

The Federal Lands Highway Division (FLH) of the Federal Highway Administration (FHWA) promotes development and deployment of applied research and technology applicable to solving transportation related issues on federal lands and with our state transportation partners. The FLH provides technology delivery, innovative solutions, recommended best practices, and related information and knowledge sharing to federal agencies, tribal governments, and other offices within the FHWA.

The objective of this study was to provide rapid geotechnical assessment, evaluation, and management methodologies to assist Federal Land Management Agencies (FLMAs) and lower annual daily traffic transportation departments and agencies among our state transportation partners to manage their unstable rock and soil slopes. Management tools include condition assessments that consist of hazard and risk evaluation, digital field data collection applications and an Internet-based searchable database, examples of performance measures, and scalable and flexible cost/benefit and quantitative risk assessment prioritization techniques as part of this research and development project.



---

Timothy G. Hess, P.E.  
Associate Administrator for Federal Lands  
Federal Highway Administration  
Federal Lands Highway

## Notice

This document is disseminated under the sponsorship of the U.S. Department of Transportation in the interest of information exchange. The U.S. Government assumes no liability for the use of the information contained in this document. This report does not constitute a standard, specification, or regulation.

The U.S. Government does not endorse products or manufacturers. Trademarks or manufacturers' names appear in this report only because they are considered essential to the objective of the document.

## Quality Assurance Statement

The FHWA provides high-quality information to serve Government, industry, and the public in a manner that promotes public understanding. Standards and policies are used to ensure and maximize the quality, objectivity, utility, and integrity of its information. FHWA periodically reviews quality issues and adjusts its programs and processes to ensure continuous quality improvement.

## Technical Report Documentation Page

1. Report No. FHWA-FLH-19-002	2. Government Accession No.	3. Recipient's Catalog No.	
4. Title and Subtitle Unstable Slope Management Program for Federal Land Management Agencies		5. Report Date January 2019	
		6. Performing Organization Code	
7. Author(s) Darren Beckstrand, David Stanley, Paul Thompson, Eric Bilderback, Mike Wittie, Upulee Kanewala, Eli Cuelho, and Douglas A. Anderson		8. Performing Organization Report No.	
9. Performing Organization Name and Address Western Transportation Institute PO Box 174250 Bozeman, Montana 59717-4250		10. Work Unit No. (TRAVIS)	
		11. Contract or Grant No.	
12. Sponsoring Agency Name and Address Federal Highway Administration 610 East 5 <sup>th</sup> Street Vancouver, WA 98661		13. Type of Report and Period Covered Final Report	
		14. Sponsoring Agency Code	
15. Supplementary Notes This project was funded under several programs. Phase I was funded under the FHWA Federal Lands Highway Coordinated Technology Implementation Program (CTIP). Phase II was funded by Federal Lands Planning and Programming (FLPP), Geohazards, Extreme Weather Events and Climate Change, Technical Transfer Funds from the FHWA Resource Center – Office of Technical Services, the National Park Service Geologic Resources Division, the Oregon and Washington Region of the Bureau of Land Management, and by Region 6/10 of the United States Forest Service.			
16. Abstract The primary objective of this research project was to develop an unstable slope management program (USMP) based on transportation asset management (TAM) for use by multiple federal land management agencies (FLMAs) and lower traffic volume transportation departments and agencies among our state transportation partners to manage their unstable rock and soil slopes. TAM uses economic and engineering analysis to create a process for maintaining, preserving, rehabilitating, and replacing assets to maintain them in a state of good repair over their life cycle and for the minimum practical cost. The USMP was also founded on performance management and risk management principles. The objective was in accordance with generally accepted transportation asset management principles and with recent federal highway legislation (MAP-21 and FAST Act) and their supporting regulations. The scope of work for this phase of the USMP project included the development of a standardized rating tool, a database with searching and reporting capabilities, and a GIS-based map to display unstable slopes and rockfalls along transportation corridors. As part of the development process, examples of performance metrics for geotechnical assets were established, an assortment of scalable and flexible benefit/cost analysis procedures for differing levels of available information were developed for prioritizing slope work, and a quantitative risk analysis procedure was developed to support further risk assessment needs for some transportation partners. In addition, the research plan included tasks to create maintenance tracking forms, forms for recording new geotechnical events, and mobile software applications to conduct rapid field inventory and inspection work using hand-held devices. Final tasks associated with the project centered on the creation of various training tools and educational materials for classroom and field training sessions at several locations around the U.S.			
17. Key Words unstable slope management, geotechnical asset management, rock slopes, soil slopes, geotechnical engineering, quantitative risk analysis		18. Distribution Statement No restriction. This document is available to the public from the sponsoring agency at the website <a href="http://www.fhwa.dot.gov/engineering/geotech">http://www.fhwa.dot.gov/engineering/geotech</a>	
19. Security Classification. (of this report) Unclassified	20. Security Classification (of this page) Unclassified	21. No. of Pages 177	22. Price

# SI\* (MODERN METRIC) CONVERSION FACTORS

## APPROXIMATE CONVERSIONS TO SI UNITS

Symbol	When You Know	Multiply By	To Find	Symbol
<b>LENGTH</b>				
in	inches	25.4	millimeters	mm
ft	feet	0.305	meters	m
yd	yards	0.914	meters	m
mi	miles	1.61	kilometers	km
<b>AREA</b>				
in <sup>2</sup>	square inches	645.2	square millimeters	mm <sup>2</sup>
ft <sup>2</sup>	square feet	0.093	square meters	m <sup>2</sup>
yd <sup>2</sup>	square yard	0.836	square meters	m <sup>2</sup>
ac	acres	0.405	hectares	ha
mi <sup>2</sup>	square miles	2.59	square kilometers	km <sup>2</sup>
<b>VOLUME</b>				
fl oz	fluid ounces	29.57	milliliters	mL
gal	gallons	3.785	liters	L
ft <sup>3</sup>	cubic feet	0.028	cubic meters	m <sup>3</sup>
yd <sup>3</sup>	cubic yards	0.765	cubic meters	m <sup>3</sup>
NOTE: volumes greater than 1000 L shall be shown in m <sup>3</sup>				
<b>MASS</b>				
oz	ounces	28.35	grams	g
lb	pounds	0.454	kilograms	kg
T	short tons (2000 lb)	0.907	megagrams (or "metric ton")	Mg (or "t")
<b>TEMPERATURE (exact degrees)</b>				
°F	Fahrenheit	5 (F-32)/9 or (F-32)/1.8	Celsius	°C
<b>ILLUMINATION</b>				
fc	foot-candles	10.76	lux	lx
fl	foot-Lamberts	3.426	candela/m <sup>2</sup>	cd/m <sup>2</sup>
<b>FORCE and PRESSURE or STRESS</b>				
lbf	poundforce	4.45	newtons	N
lbf/in <sup>2</sup>	poundforce per square	6.89	kilopascals	kPa

## APPROXIMATE CONVERSIONS FROM SI UNITS

Symbol	When You Know	Multiply By	To Find	Symbol
<b>LENGTH</b>				
mm	millimeters	0.039	inches	in
m	meters	3.28	feet	ft
m	meters	1.09	yards	yd
km	kilometers	0.621	miles	mi
<b>AREA</b>				
mm <sup>2</sup>	square millimeters	0.0016	square inches	in <sup>2</sup>
m <sup>2</sup>	square meters	10.764	square feet	ft <sup>2</sup>
m <sup>2</sup>	square meters	1.195	square yards	yd <sup>2</sup>
ha	hectares	2.47	acres	ac
km <sup>2</sup>	square kilometers	0.386	square miles	mi <sup>2</sup>
<b>VOLUME</b>				
mL	milliliters	0.034	fluid ounces	fl oz
L	liters	0.264	gallons	gal
m <sup>3</sup>	cubic meters	35.314	cubic feet	ft <sup>3</sup>
m <sup>3</sup>	cubic meters	1.307	cubic yards	yd <sup>3</sup>
<b>MASS</b>				
g	grams	0.035	ounces	oz
kg	kilograms	2.202	pounds	lb
Mg (or "t")	megagrams (or "metric ton")	1.103	short tons (2000 lb)	T
<b>TEMPERATURE (exact degrees)</b>				
°C	Celsius	1.8C+32	Fahrenheit	°F
<b>ILLUMINATION</b>				
lx	lux	0.0929	foot-candles	fc
cd/m <sup>2</sup>	candela/m <sup>2</sup>	0.2919	foot-Lamberts	fl
<b>FORCE and PRESSURE or STRESS</b>				
N	newtons	0.225	poundforce	lbf
kPa	kilopascals	0.145	poundforce per square inch	lbf/in <sup>2</sup>

## TABLE OF CONTENTS

<b>Chapter 1. Introduction .....</b>	<b>1</b>
Report Organization.....	4
<b>Chapter 2. Statement of Work.....</b>	<b>5</b>
Background.....	5
Research Plan.....	7
<b>Chapter 3. Unstable Slope Management Program for FLMAs.....</b>	<b>12</b>
Geotechnical Asset Management.....	12
Defining Geotechnical Assets.....	13
Steps to Managing Unstable Slopes.....	14
<b>Chapter 4. How to Conduct Field Ratings.....</b>	<b>27</b>
Unstable Slope Rating Category Descriptions.....	27
Personnel to Perform Ratings .....	28
Equipment List.....	28
Planning .....	29
USMP Website and Mobile Applications.....	31
<b>Chapter 5. How to Set and Use Performance Measures .....</b>	<b>33</b>
Importance of Tracking Geotechnical Events .....	34
Setting Agency-Specific Performance Goals .....	35
Slope Condition Rating and Performance Measures .....	37
Example of Performance Monitoring for U.S. Forest Service .....	38
<b>Chapter 6. How to Use Benefit/Cost Approaches .....</b>	<b>40</b>
Various Approaches to Benefit/Cost Calculations .....	40
Selecting the Appropriate Approach.....	44
Cost Estimation.....	44
Examples from Gifford Pinchot National Forest.....	45
<b>Chapter 7. How To Conduct Quantitative Risk Assessment .....</b>	<b>49</b>
QRA Analysis Factors .....	50
Estimated chance of an Incident .....	53
Risk Reduction Benefit/Cost Analysis .....	53
<b>References .....</b>	<b>54</b>
<b>Appendix A. USMP Rating Form Detailed Descriptions .....</b>	<b>57</b>
<b>Appendix B. USMP Rating Forms .....</b>	<b>96</b>
<b>Appendix C. Detailed Instructions for USMP Website and Mobile Applications.....</b>	<b>103</b>
<b>Appendix D. Benefit/Cost Approach for Rock and Soil Slopes .....</b>	<b>114</b>
<b>Appendix E. Gifford Pinchot National Forest Cost Estimation .....</b>	<b>140</b>

<b>Appendix F. Unstable Slope Performance Measures for FLMA's Using USMP Ratings...</b>	<b>151</b>
<b>Appendix G. Qualitative Risk Analysis Online Form and Usage.....</b>	<b>164</b>

**List of Figures**

Figure 1. GAM Process (Thompson, 2016).....	15
Figure 2: FLMA GAM Process Roadmap .....	16
Figure 3. Navigation Bar for USMP Website and Mobile Applications. ....	31
Figure 4. USMP Searching and Reporting Interface .....	32
Figure 5. Virginia DOT Performance Dashboard (VDOT website – accessed December 16, 2016).....	33
Figure 6. BLM Transportation System Modes .....	36
Figure 7. Landslide on a BLM road, southwest Oregon.....	36

**List of Tables**

Table 1. Good, Fair, and Poor Classifications for USMP Slopes. ....	38
Table 2. Example Performance Measure Table for U.S. Forest Service (bold text indicates examples filled in). ....	39
Table 3. Sites used in benefit/cost calculations with selected site information. ....	46
Table 4. Calculating Benefit/Cost ratios or Priority Indexes for Gifford Pinchot National Forest sample sites. The USMP sites have also been ranked under each analysis alternative.....	47
Table 5. Priority index for Gifford-Pinchot sites calculated using Alternative 3, and organized from highest to lowest index score (note that rockfall and landslide hazards have been analyzed separately in the rankings). ....	48

## CHAPTER 1. INTRODUCTION

Transportation corridors for roads and trails in our Federal lands contain numerous unstable slopes, both natural and constructed (cut slopes and embankments), all subject to some form of failure – from slow creep failures to sudden rockfall. These slope failures may be simple maintenance nuisances that require an out of ordinary expenditure of public funds, but sometimes they are serious incidents that cause loss of life, injury, and property damage; block use of roads or trails; and cost into the millions of dollars.

Federal engineering geology and geotechnical staff recognized that geotechnical asset management (GAM) could be adaptable to Federal lands agency use and initiated this research and development effort using the Coordinated Technology Implementation Program (CTIP) program. The Alaska Department of Transportation and Public Facilities (AKDOT&PF) was selected as the contractor for Phase I, because the agency had already begun an extensive research project to create a pioneering GAM program addressing slopes and other geotechnical assets. Following the initial project, additional non-CTIP funding through Federal Lands Planning and Performance Management (FLPP), Climate Change, and Unstable Slope Hazards was allocated for a second phase, and the primary contractor became Western Transportation Institute (WTI) at Montana State University. Subconsultants Landslide Technology, Paul D. Thompson and DA Stanley Consulting, all of whom worked on the AKDOT&PF GAM research projects and Phase I of this project, were also retained for Phase II.

Recently, with the growing acceptance of Transportation Asset Management (TAM) and impetus from the Federal legislation, agencies have begun to develop systems to manage a wide range of geotechnical assets using TAM principles. Modern, proactive asset management-based programs are based on maintaining assets in a state of good repair, meeting a required level of service in the most transparent and cost-effective manner, and considering economics and life cycle costs for the transportation network as a whole, rather than focusing on single assets, one at a time. Performance management adds in the element of setting and meeting appropriate performance levels and goals established by the agencies. Risk management is also considered part of the process in the modern systems approach to assess risk cost as an integral part of economic analysis. These principles formed the basis of the Unstable Slope Management Program (USMP) for Federal Land Management Agencies (FLMAs).

Following completion of the Phase I work, further research and development was initiated through 17 tasks, outlined in Chapter 2. The research plan for the USMP Phase I and II projects included: developing standardized rating categories, establishing examples for asset management performance measures, developing a database and integrating it with an open-source GIS-based platform, creating scalable and flexible benefit/cost analysis procedures for differing levels of available information to prioritize unstable slope work, and developing a quantitative risk analysis procedure to support further risk assessment needs for some transportation partners. In addition, the research plan included tasks to create maintenance tracking forms, forms for recording new geotechnical events, and mobile software applications to conduct rapid field inventory and inspection work using hand-held devices. Final tasks associated with the project

centered on the creation of various training tools and educational materials for classroom and field training sessions at several locations around the U.S.

The primary objectives under Phase I was to establish a standardized set of rating criteria for all FLMAs, to develop a standardized rating form that included hazard and risks associated with unstable slopes, to test the standardized rating form in a project demonstration on the Gifford Pinchot National Forest in southwest Washington State, and to develop a brief video about the USMP and its value to managing slope assets and meeting the Moving Ahead for Progress in the 21st Century Act (MAP-21) policies. To build on the Phase I work, four major objectives were set as part of Phase II to accomplish the work outlined within this project: 1) establish a standardized evaluation system to rate and track unstable slopes through the development of a searchable database with a GIS-based platform, 2) provide examples for performance measures, 3) create scalable and flexible benefit/cost approaches for differing levels of available information, and 4) develop a quantitative risk analysis tool. Each of these major tasks is briefly summarized below.

A stakeholder group consisting of members from the National Park Service (NPS), the Bureau of Land Management (BLM), and the United States Forest Service (USFS) was established to help guide and verify the various developments associated with this project. The USMP is thought to be relevant and useful to several other state and federal agencies, including but not limited to, the Bureau of Indian Affairs (BIA), the U.S. Army Corps of Engineers (USACE), the U.S. Bureau of Reclamation (USBR), the U.S. Fish and Wildlife Service (USFWS), and state and county departments of transportation, including urban Metro Park departments.

Activities related to the primary objectives of Phase II include the following:

- Standardized Unstable Slope Evaluation and Tracking System with a Database on a GIS-based Platform. A standardized relative-rating evaluation system for unstable soil and rock slopes customized for low-volume roads and trails typically found on FLMA lands was developed during Phase I. A two-page standardized rating form was created to rapidly conduct field ratings of unstable rock and soil slopes on both roads and trails. This evaluation system includes hazard and risks associated with unstable slopes and is the cornerstone of the Unstable Slope Management Program for FLMAs. Three asset and performance management supporting forms were also developed to: 1) track the occurrence of new unstable slope events to alert transportation managers, 2) document maintenance activities related to unstable slopes to track deterioration of unstable slopes, and 3) record pertinent cost estimate data for various risk reduction and full mitigation alternatives for highly rated unstable slopes within a given corridor or high use area.
- Performance Measures. An FLMA-focused Performance Management (PM) framework was developed for select geotechnical assets to measure progress toward agency goals. Performance measures are indicators of work performed and results achieved. Performance measures are also the quantitative indicators of the service provided by the agency's transportation system to the user. Performance measures range from high level



generalized agency-wide aspirational “management” goals to asset-specific “condition” goals. Using the road network management approach developed by the USDA Forest Service, the research team developed sample Performance Measures that can be used as a guide by other FLMAs to develop their own agency-specific Performance Measures based on their agency mission, land management approach, and policy goals.

- **Benefit/Cost Analysis Approach.** The benefit/cost analysis process assists FLMAs as they seek to prioritize slope assets in order to maintain a state of good repair or improve their status. It is necessary to set priorities and make decisions about agency resource allocation to ensure limited funds are used in the most efficient way possible. In TAM practice, the fundamental framework for setting priorities and allocating resources is based on benefit/cost comparisons. The research team (led by Paul Thompson for this task) created a simple yet flexible approach to set priorities and allocate resources, based on varying levels of available information. The different approaches provide an objective and consistent means of summarizing the degree to which each project may contribute to agency objectives while minimizing long-term cost and risk.
- **Quantitative Risk Analysis.** An independent quantitative risk analysis (QRA) module was also created as part of this project. It was designed to augment the unstable slope ratings as a risk-based prioritization tool or separately to analyze unstable rock or soil slope risk to individuals or public land users in areas where corridors have not been rated with the USMP evaluation system. The output from this analytical tool can be compared to other common societal risks (such as worldwide landslide fatalities, earthquakes, health issues, and vehicular accidents). To achieve a greater degree of transparency, reproducibility, and comparability in risk assessment, the NPS-Geologic Resources Division (GRD) has been using a QRA method that relies on empirical, modeled, or estimated probabilities. This useful method was adapted for use within the USMP tool. The graphical user interface developed for FLMA managers as part of this project allows for expeditious use of the QRA.

Databases were set up for the storage, searching and calculation of unstable slope rating data. An associated GIS-based map interface was also created to display this data spatially. Paper forms are also available to collect field data, which can be input manually into the database through the USMP website. In addition, to optimize efficiency, field data collection applications were developed for Android and iOS mobile devices to automatically store, calculate, and upload field data. USMP data can be exported or connected from the USMP website interface for use in previously developed FLMA-specific databases and compatible GIS systems.

Project information was disseminated through two-day training courses teaching how to rate unstable rock and soil slopes at three locations in 2017: 1) Great Smoky Mountains National Park in Gatlinburg, Tennessee, 2) Denver Service Center for the National Park Service in Lakewood, Colorado, and 3) Western Federal Land Highway Division (WFL) Offices in Vancouver, Washington. Training courses were free of charge and spanned two days; one classroom day and one field day.

## **REPORT ORGANIZATION**

This manual is intended to introduce the reader to the background of asset and performance based management as it is applied to unstable slopes (soil and rock) along transportation corridors, and to outline the process of establishing, employing, and managing a USMP within your agency. It begins by outlining the background and essential parts of the unstable slope management program as it relates to geotechnical asset management strategies (Chapter 3). Chapter 4 describes how to rate unstable slopes in the field. A detailed description of each section of the rating form, along with its various calculations, is included in Appendix A. The rating forms themselves are provided in Appendix B, and can be printed out for use in the field. Use of the mobile applications is also described in Chapter 4, and detailed instructions on how to download and use the mobile applications is included in Appendix C. Chapter 0 describes examples on how to use and set performance measures, using the U.S. Forest Service's road maintenance levels as the management framework. A detailed description of the performance measures concept is included in Appendix F. Chapter 6 describes how to conduct a benefit/cost analysis for the USMP, and includes a general description of benefit/cost approaches having different levels of available data for rock and soil slopes (refer to Appendix D). Finally, Chapter 7 outlines the quantitative risk analysis and how it can be used to understand and manage risk by your agency as it relates to an USMP. Examples describing the use of the QRA are included in Appendix G.

## CHAPTER 2. STATEMENT OF WORK

Transportation corridors consisting mainly of roads and trails within our federally managed lands contain numerous unstable and potentially unstable slopes and slope failures. A variety of unstable slopes, including natural and constructed rock slopes, soil cut slopes and embankments, are all subject to failures occurring as rockfall, landslides, debris flows, creep, and settlement. These instabilities range in severity from maintenance nuisances that generally go unnoticed by the traveling public, to those that can block traffic or trail usage, or to those that cause injury and/or property damage. Although slope failures that cause significant property loss or loss of life are not most common, unstable slopes along a transportation corridor are a problem for the agency responsible for providing and maintaining safe and efficient transportation for people and goods. Consistent with the Federal efforts for overall disaster preparedness and risk reduction, many state transportation agencies are moving towards proactive risk management strategies to help mitigate unstable slopes; however, there has been little information to guide FLMAs, tribes, and state agencies (such as state, county, cities, state parks, and metropolitan parks) with low to very low traffic volumes and various levels of trail usage on how to manage slopes using asset and performance management principles. This project was created to provide guidance to manage geotechnical assets by developing and implementing an unstable slope management program (USMP) for FLMAs, tribes, and other local or state agencies with similar assets and infrastructure assessment needs.

### BACKGROUND

Under the first phase of this project, two primary road corridors with known unstable slopes were identified for use in the field demonstration of the USMP. The road corridors were in the Gifford Pinchot National Forest (in southwest Washington State) on Forest Service Roads 25 and 99. The primary task of this first phase included identifying stakeholders in partnering agencies, and providing, developing, and presenting geotechnical asset management materials to educate the team about unstable slope asset and performance management. Input from the stakeholders was used to refine the AKDOT&PF's unstable slope rating criteria for FLMAs with very low to low volume roads and significant trail network usage. FLMAs also requested development of a brief video about development of the USMP and its value to managing slope assets and meeting the Moving Ahead for Progress in the 21st Century Act (MAP-21) requirements. A draft USMP rating form, calculations, and rating criteria definitions were produced prior to demonstrating the field inventory and condition survey at approximately 20 unstable slopes consisting of both soil and rock unstable slopes of varying condition and severity. Following the field demonstration with the partnering agencies (NPS, USFS, BLM, BIA, and WFL of FHWA), the standardized unstable slope rating forms, calculations, and rating criteria definitions were finalized and presented in a report that included maps of the demonstration corridors with completed rating forms, site photographs, and a ranked list of the unstable slopes with their slope ratings.

Inventorying and assessing the condition of unstable slopes is the first step in managing them; however, understanding the magnitude of the problems associated with unstable slopes requires more information and analysis. Successful management also includes an understanding of the

costs associated with maintaining, fixing, and replacing such assets. Asset management is being used with increasing frequency as a means of reducing overall life-cycle costs. Geotechnical Asset Management (GAM) is in its infancy within most public agencies, and specifically within FLMAs, while assets such as pavements, bridges, and some larger culverts are usually more commonly inventoried and managed. Geotechnical assets (such as unstable slopes, retaining walls, and material sources) are typically handled using a reactive approach when a slope failure closes a trail or roadway. Emergency funds, often from other road and trail maintenance funds, are used to mitigate unstable slopes, thereby shortchanging the intended use of those funds for other programmed maintenance needs. GAM tools such as the USMP provide a proactive approach to inventorying, assessing, prioritizing, and requesting dedicated funds for mitigation efforts. In addition, asset management under the MAP-21 Act, and now the Fixing America's Surface Transportation (FAST) Act, mandates that asset and performance management tools be developed and utilized to manage bridge and pavements, provide transparency to the public, and determine strategic infrastructure needs to most efficiently use the limited and uncertain funding sources for these types of preservation and safety improvement projects. Proactive management of ancillary assets is encouraged, with regulatory flexibility provided for agencies to enact customized or incrementally implemented management plans for assets such as soil and rock unstable slopes.

The value of asset and performance management is to base decision-making on a proactive, strategic approach that takes a long view of performance and cost using analytical tools to allow for alternative comparisons. Accurate and effective asset management is founded on a database of relevant information collected during routine or periodic inventories and condition assessments. Agency performance goals and standards are needed to evaluate the asset and to determine whether to abandon, repair, or replace the asset in a strategic manner.

The USMP is innovative and unique because of its application of the principles of asset and performance management to geotechnical assets. As part of the implementation process, the USMP will provide guidance on setting and validating performance goals and standards for unstable slope assets. This work will benefit all partnering agencies by providing them significant cost saving through applying asset and performance management principles for unstable slopes. The program will also provide policy statement examples about safety and service life goals for managing unstable slope assets.

One significant method of incorporating asset and performance management principles and meeting the MAP-21 and FAST Act forward-looking requirements is to implement an USMP in FLMAs. Asset management for unstable slope assets covers four general areas: 1) building an inventory of unstable slope assets that includes their condition, 2) establishing performance standards and service life criteria, 3) identifying and developing risk reduction corrective actions, and 4) prioritizing and taking risk reduction corrective actions.

The second phase of this project was to develop, verify, and demonstrate a database for unstable slopes that could be populated using a web-based electronic form or via iOS-based and Android-based applications that function off-line and upload when back online. Data generated from

USMP ratings is displayed graphically on a map to facilitate simple and quick visual assessments. Additional development under this phase also included creating a form to document new unstable slopes that occur, a maintenance form to track deterioration of unstable slopes to stage risk reduction work or mitigation, and a search and reporting tool that allows users to harvest the data and analyze it as they see fit. The quantitative risk analysis (QRA) tool is included in the USMP work to provide risk assessments for unstable slopes that may not have data in an USMP already, or it can be used to help quantify the risk associated with a given unstable slope as it relates to comparisons with other societal risks, such as auto accidents fatalities, lightning strikes, or being a victim of violent crime. All accomplishments from this second phase are documented in this manual for users, and three free two-day seminars were held around the U.S. to train potential users of the program. The following tasks were undertaken as part of the second phase of this project to develop and execute a robust and useful USMP for FLMAAs.

## **RESEARCH PLAN**

The tasks outlined below address the objectives of this phase (Phase II). Tasks 1, 4, 5, 6, 8 were led by Landslide Technology of Portland, Oregon with significant assistance from subconsultants DA Stanley Consulting and Paul D. Thompson. Tasks 2, 3, 7, 10, 11, 12, 13, and 14 were led by the Western Transportation Institute (WTI) and the Computer Science department at Montana State University in Bozeman, Montana. Tasks 9 and 15 had shared responsibility between Landslide Technology, Inc. and WTI. This phase of research was coordinated by WTI through a contract with WFLHD.

### **Task 1 – Develop Examples of Performance Measures**

Task 1 was to develop performance measures for the USMP based on the system used by the United States Forest Service (USFS), which manages its roadway system by utilizing five distinct Maintenance Levels, each with their own usage goals and objectives (refer to Chapter 5). Performance Measures were divided into two general categories, Condition Performance Measures and Management Performance Measures. The Performance measurements based on condition followed and expanded upon examples outlined in an FHWA Office of Transportation Performance Management fact sheet describing a Notice of Proposed Rulemaking (NPRM) for pavements and bridges (Federal Highway Administration, 2015). Performance measures based on management are intended to track how well the Agency is proactively managing and improving their unstable slope assets over time using data obtained during the slope rating procedures, and tracking of maintenance records for road-closing unstable slope events, as well as mitigation and risk reduction projects.

### **Task 2 – Database Development**

Task 2 was to develop a searchable database based on open-source technologies (such as Postgres and MySQL) that is appropriate for USMP management needs. The database accepts input from field ratings and measurement using web forms, or direct input through an application programming interface (API). The database is integrated with the GIS-based platform developed

in Task 3, described below. Stored data is available to future applications of USMP data through read-only SQL queries (Task 10). Complementary mobile device applications, based on Android and iOS platforms, were developed for field use as part of Task 13 to expedite data gathering, uploading, and saving in the database.

### **Task 3 – GIS Platform Development**

Task 3 was to develop a map-based GIS platform that presents the information from the USMP database. It provides users with a graphical method for data query and content creation. Stored USMP data can be displayed on an interactive map through interactive, color-coded icons and callouts. Content creation is supported through web forms available to field operators, or through an API. The web forms also support uploading of scanned documents and photographs to be associated with the rated unstable slopes.

### **Task 4 – Input Phase I Unstable Slope Inventory Data**

Task 4 was to test the USMP database with the map-based GIS platform using the Phase I unstable slope inventory condition information and the US Forest Service’s preliminary service life estimates for slopes, and to set performance standards based on service life (based on Task 1) to determine what slopes are identified for possible risk reduction corrective action. Ten slopes were prioritized for conceptual design and cost estimating in the field.

### **Task 5 – Site Visits**

Task 5 was to rate ten additional unstable slopes in the field within the demonstration corridor to test the field data collection and GIS-based platform developed under Task 2 and 3, and to further test the USMP database and the map-based GIS platform. The 10 unstable slopes used to assess conceptual design alternatives and cost estimating were used to develop the benefit-cost alternatives under Task 6.

### **Task 6 – Cost-Benefit Formulation**

Task 6 was to write a summary document to synthesize a series of alternative approaches for benefit/cost prioritization of slope preservation, mitigation, and reconstruction. The alternative approaches focused on differing levels of available agency data to feed the benefit cost formulations. All the approaches were based on widely-accepted principles of risk management and asset management, with varying levels of data requirements. The approaches are meant to provide an objective and consistent means of summarizing the degree to which each project may contribute to agency objectives while minimizing long-term cost and risk. An accompanying spreadsheet program was included to provide the necessary benefit factors for use in the formulas, and to demonstrate their use.

### **Task 7 – Database and GIS Map Integration**

Task 7 was to create a single platform to deliver a fully functional open source database, web form, and map-based GIS platform based on the work accomplished in Tasks 2 and 3. The

database and GIS-based map will be available for use on desktop computers, iOS, and Android applications (Task 13).

### **Task 8 – Development of Field Manuals**

Task 8 was to produce a brief and simple manual to outline the procedure for planning and rating unstable slopes and to describe the use of the database and associated map-based GIS platform.

### **Task 9 – Produce a Training Video on How to Rate Unstable Slopes**

Task 9 was to produce a video training tool to aid deployment of the USMP to FLMAAs. The training tool focuses on planning field work and rating unstable slopes.

### **Task 10 – Develop a Searching and Reporting Tool for the USMP Database**

Task 10 was to develop a front-end web form to allow searching the contents of the USMP database by multiple categories and allow refined searches in at least three sub-categories. Reporting of the tabular data resulting from the searches can be presented in a spreadsheet-type format containing the categories and search ranges used for the search criteria and the resulting data. The “search and report” web form is linked to the USMP web-based GIS platform developed in Task 7 to illustrate the results of the search criteria geographically.

### **Task 11 – Maintenance Tracking Form**

Task 11 was to develop a web form that can be used in the field by maintenance crews (even in the absence of an internet connection). Off-line data can be automatically downloaded into the USMP database upon reconnecting to the internet. This tracking form was intended to be used for normal, scheduled maintenance activities associated with known unstable slopes. The form can be used to capture the level of effort and associated costs required to maintain the roadway or trail, re-open the road or trail, or preserve the integrity of the roadway through specialized maintenance projects.

### **Task 12 – New Slope Event Form**

Task 12 was to develop a web form that can be used in the field by FLMA personnel (even in the absence of an internet connection). Off-line data can be automatically downloaded into the USMP database upon reconnecting to the internet. This form is intended for new unstable slopes not already in the USMP inventory. In the future, an email function could be added to this form to automatically alert designated FLMA agency officials to trigger a possible field visit and/or full unstable slope rating when information from a new unstable slope form is added to the USMP database.

### **Task 13 – iOS and Android Application Development**

Task 13 was to develop iOS-based and Android-based applications as supplemental alternatives to the PC platform developed as part of Tasks 2, 3, 7, 10, 11 and 12 described above.

Application platform choices will encourage more usage by FLMA agency users and are less costly for FLMAs to implement.

#### **Task 14 – Develop Quantitative Risk Analysis Module**

Task 14 was to develop a Quantitative Risk Analysis (QRA) module as a graphical user interface implementation of the four factor QRA equation used by NPS-GRD. Probability factors and items affecting probability factors such as rock size and number of boulders for rockfall, speed of traversing the hazard area, and stopping distance required to avoid the hazard were used to generate an annual or daily individual risk of death or injury. Risk probability could then be compared with other societal risks in an output comparison graph. Risk of death or injury occurrence and societal costs could also be estimated through input of the number of people exposed to the risk and an implementation of the U.S. Department of Transportation's (USDOT's) Value of Statistical Life guidance.

#### **Task 15 –USMP Technology Deployment and Training Course**

Task 15 was to develop and deliver up to four two-day training courses across the United States to educate potential users how to use the USMP rating tools and associated software. This training helped facilitate implementation of the USMP for FLMAs. Training consisted of one-day of office level instruction and one-day of field training. Students learned how to prepare for rating slopes, input data into the various web forms, interact between the USMP database and map-based GIS platform, and download the collected field data from the software applications when returning to the office.

#### **Task 16 – Present USMP to FHWA Performance Management Team and FLMA Leadership**

Task 16 was to present the USMP to the FHWA Performance Management Team and the FLMA Performance Management Leadership Team. This helped inform upper management of the unstable slope management program and its potential benefits to many FLMAs.

#### **Task 17 – Provide Marketing Materials for Technology Deployment and Training Courses**

Task 17 was to develop an electronic brochure describing the benefits of unstable slope asset management available through the free training course offered as part of Task 15. The brochure described how the training course will prepare an attendee to collect and manage data collection and analysis in the USMP database and GIS map-based platform. The electronic brochure targeted FLMA personnel, road managers, trail managers, Federal geotechnical consultants, municipalities, counties or metro parks personnel, and consultants.

The value of asset and performance management is utilizing a proactive, strategic approach to make decisions that take a long view of performance and cost, and are based on accurate information using analytical tools to allow for alternative comparisons. Asset and performance management is founded on accurate data in asset inventories and condition assessments. Agencies employing this system can set performance standards to determine the optimal



approach once the service life of the asset is understood. This work will benefit all partnering agencies by providing them significant cost savings through applying asset management principles for geotechnical assets. It can also result in providing policy statements about safety and service-life goals for managing geotechnical assets, such as unstable slopes.

The third phase of this project, which is currently unfunded, entails providing a stable, long-term information technology environment for the USMP database. This includes the following proposed Information Technology (IT) solutions:

- Locating a cost-effective location(s) to house the USMP data for all FMLAs (for example, with the Roadside Inventory Program (RIP), Guardwall Inventory Program (GIP), and Wall Inventory Program (WIP) databases located and managed by Eastern Federal Lands and Headquarters of FHWA; or at each participating agency).
- Updating the operation and maintenance of the database and web-based map platform to ensure the platform is stable and functional.
- Establishing data quality control and assurance to ensure database integrity.
- Performing database cleanup and IT projects to ensure compatibility and connectivity with other FMLA corporate databases.
- Ensuring data are available in a timely fashion to provide more transparent decision making that translates to more effective and efficient management of FLMA roads and trail networks.

Overall, the third phase of the project seeks to provide longevity for this USMP asset and performance management program decision support tool by performing regular maintenance and providing operational support from IT staff so that the data remains available, error-free, and centralized for continued use by FLMA personnel.

### **CHAPTER 3. UNSTABLE SLOPE MANAGEMENT PROGRAM FOR FLMAS**

Federal Land Management Agencies (FLMA) are taking part in the national and international trend toward better management of public assets through the concepts of Transportation Asset Management (TAM). It is commonly understood that transportation infrastructure is aging faster than national, state and local governments can manage with traditional methods. TAM is a strategic and systematic process of maintaining and managing infrastructure assets throughout their life cycle, focusing on business and engineering practices for resource allocation and utilization. It uses data and analysis to improve decision making, with the objective of providing the required level of service in the most cost effective manner (Gordon, et al., 2011). Simply put, TAM and associated system management programs provide a better than traditional means for designing, building, operating, maintaining and replacing transportation works.

Most transportation agencies have generally reacted to geotechnical problems as they arose, whether the issue was a landslide, a failed embankment or road closures due to rockfall events. Recently, however, there has been a move toward applying asset management principles and processes to geotechnical assets. More recently, a greater understanding of and an appreciation for the role these “dirt” assets in transportation systems, and Geotechnical Asset Management (GAM) is increasingly recognized as an integral part of transportation asset management.

FLMAs, through the Federal Highway Administration’s WFL office, have undertaken a research and development project to explore use of GAM principles in developing an unstable slope management program tailored to the needs of FLMA transportation systems. The USMP project is broadly discussed in the preceding chapters. This chapter summarizes the major components of the USMP, and outlines the steps taken to develop and implement it.

#### **GEOTECHNICAL ASSET MANAGEMENT**

Transportation agencies spend a significant portion of their funds on geotechnical assets, the value of which may be on a par with or exceed the value of the agency’s “primary assets,” which are usually considered to be pavement and bridges. For instance, the combined replacement value for Alaska’s inventoried geotechnical assets (retaining walls, rock slopes, unstable soil slopes) was three times the replacement cost of the state’s bridge assets (Thompson, et al., 2016). By applying the same types of systems management techniques to geotechnical assets as are applied to bridges and pavement, FLMAs can reasonably expect improvements in condition and performance of geotechnical transportation assets along with reductions in life cycle costs.

Geotechnical assets are generally different from bridges and other “bricks and mortar” transportation assets. Some geotechnical assets, such as retaining walls, may be managed in very similar means. However, other geotechnical assets, like embankments and constructed soil slopes, are very different in character because they are built of non-homogeneous materials such as soil and rock, or constructed of combinations of soil, rock, geotextiles and more traditional steel and concrete. The taxonomy of geotechnical assets is not yet settled, but the concepts have recently been proposed (Anderson, et al., 2016).

As geotechnical assets deteriorate during their life cycle, most transportation agencies resort to a short term “worst-first” approach in determining when or whether to ignore, repair, rehabilitate, or replace the asset. For example, rockfall inventory programs in many states rank rockfall sites so that the most dangerous in the transportation system receives attention first. However, expending limited funds on worst-first short-term problem fixes (Pierson & Van Vickle, 1993) results in steadily declining conditions for transportation systems. This result is inevitable since agencies do not have the resources to address all problems. Ignoring most assets to fix only those in the worst condition means missing opportunities to make lower cost repairs that extend the life of assets, which is not cost-effective (Sanford Bernhardt, et al., 2003). Asset management facilitates spending to gain the most long-term, positive effects to get the most “bang for the buck.”

## **DEFINING GEOTECHNICAL ASSETS**

The literature of Geotechnical Asset Management offers significant guidance on which assets are considered geotechnical assets. The earliest publications on GAM in the U.S. are from the early 2000s. About ten years later, GAM development took a leap forward, and there are now numerous publications, webinars, conference presentations, and related resources that address program development. Many of these documents address the issue of what assets should be included in a GAM program.

More recently, the emphasis in development has changed to looking forward and determining how to implement these programs. With that change has come a need to understand what assets should be included in GAM programs, how they are characterized, and how relevant terminology should be defined. Where possible, GAM practitioners will use the same terminology already in use in transportation asset management (Anderson, et al., 2016; Sanford Bernhardt, et al., 2003; Vessely, 2013).

Below is a list of geotechnical assets that could be managed using GAM principles. Only a handful of these would be expected to apply to the FLMA USMP and no program is likely to manage all or even most of the assets listed here. However, it may be useful to FLMAs to look ahead to more mature GAM/TAM programs that could include the assets included in the list below (Anderson, et al., 2016; Sanford Bernhardt, et al., 2003):

- Rock slopes.
- Rockfall mitigation elements including barriers, wire and cable mesh, rock bolts, and anchors, as separate, independent assets.
- Embankments and constructed cut slopes.
- Landslides and rockfall sites.
- Earth retaining structures/retaining walls (retaining walls, reinforced soil slopes, and earth and rock buttresses).
- Culverts and drainage channels.
- Horizontal drains.

- Pavement subgrade.
- Foundations.
- Buried structural components.
- Bridge foundations.
- Tunnels.
- Materials sites (borrow, pit, and quarry sites).
- Subgrade and land within right-of-way.
- Buried reinforcing elements, rock bolts, tieback anchors, and other buried structural elements.
- Instruments: slope indicators, piezometers and standpipes, and thermistors.
- Geotechnical data (slope movement survey data, lab testing, temperature data, slope indicator data).

## **STEPS TO MANAGING UNSTABLE SLOPES**

There are many state transportation agencies in the U.S. that have some form of management system for unstable slopes. Most of these programs have inventory and rating systems, but have not taken steps to integrate slope programs with the broader transportation asset management or performance management programs. A few agencies have taken steps to address unstable slopes from the standpoint of risk management.

The steps required to initiate and maintain an unstable slope management program for FLMAAs will vary from agency to agency because there can be considerable differences in the asset mix and goals and objectives between, for example, the USFS and the NPS. USFS has a high proportion of roads versus managed acreage to provide access to timber cutting areas. These roads may receive heavy use for a few years, and then be placed in “storage” for perhaps decades, until another timber cutting area is opened along the route. USFS has other low service roads that are not maintained for standard vehicle travel. NPS has numerous roads in national parks that generally are kept open continuously to allow public access; however, the road miles crossing NPS land are limited in comparison to those crossing USFS lands in order to preserve the condition and character of the landscape.

The same road-closing unstable slope event might have a low impact on USFS forest lands, but a major impact on national park land. Thus, the strategies are different between agencies for maintaining slopes or other geotechnical assets that can potentially close a corridor.

Performance measures to set targets for agencies to keep roads open will be different. Another similar issue arises in developing management techniques for low volume, low speed roads or trails versus high speed, high volume roads. There will be much less urgency for remediation of failed slopes for low volume roads or trails than for major arteries crossing public lands.

At the time of the creation of this manual there were no standardized Federal guidelines for implementing a comprehensive GAM program, though the transportation departments of Alaska and Montana are well on their way to developing their own programs for various geotechnical

assets. However, there is no widely accepted set of steps to develop, execute and maintain a GAM program. GAM researchers generally agree that the steps should mirror the accepted steps for the transportation asset management process, adapted as needed for the differences in the asset types. The AKDOT&PF program has illustrated the GAM process as shown in Figure 1.

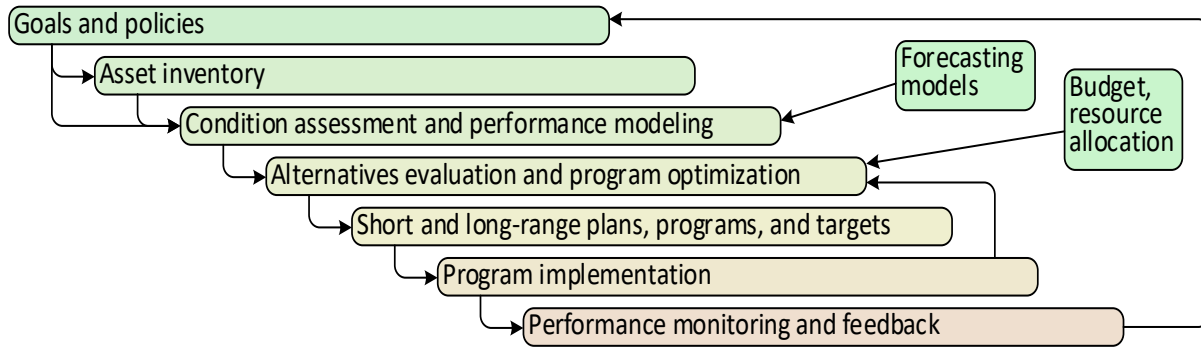

©2016 Thompson

**Figure 1. GAM Process (Thompson, 2016)**

This comprehensive process ensures that AKDOT&PF will continuously measure the performance of its geotechnical assets, and that its investments are cost-effective in improving performance. The figure shows there is a clear relationship between decision-making for geotechnical assets and agency objectives. The process includes consideration of alternatives based on benefit/cost calculations and feeds data to short-term and long-term planning to support budget allocations. A somewhat simpler, though consistent, roadmap for the FLMA USMP programs is proposed in Figure 2. The FLMA process, with its focus on slopes, need not address a variety of dissimilar assets, but must be flexible enough to account for inter-agency differences in asset types, performance goals, objectives, and policies, as discussed above.

The FLMA roadmap is general, as it must be to address the needs of several agencies. However, it leads to the specific steps necessary to execute a GAM-based USMP program, to create performance measures consistent with agency goals and objectives, and to conduct the economic analysis each agency needs to support decision-making for the agency.

With these basics in mind, what are the steps in creating performance measures and metrics? An axiom for transportation asset management is that performance measures must be “S-M-A-R-T” (specific, measurable, achievable, relevant and time bound) (Cambridge Systematics, 2002). In setting performance measures for FLMA, these factors must be considered for each measure or key performance indicator.

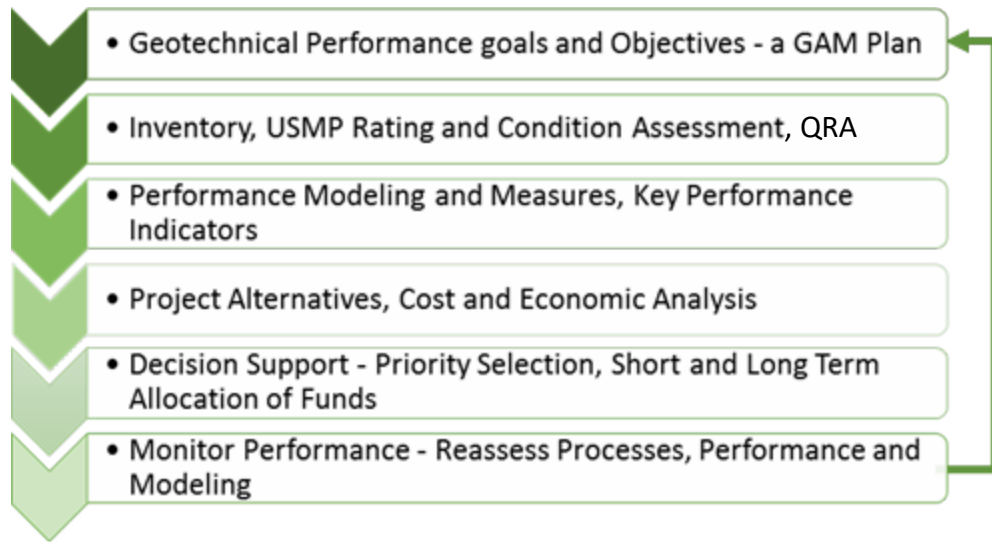

**Figure 2: FLMA GAM Process Roadmap**

**Step 1 – Identify applicable high-level agency performance goals and objectives.** Begin with an outlined GAM Plan that includes reference to documents that set out agency performance measures that address transportation assets and corridors, and especially maintenance and operations metrics. Performance measures proposed here may take advantage of metrics that do not expressly address slopes but address similar assets, and management concepts that will fit slopes. As noted above, review of agency documents shows agency will likely have very complete high-level goals, objectives, and policies, which will apply to the USMP. Many of the agencies may have specific performance measures already in place to address slope issues. It is expected that adaptation of existing performance measures and development of new performance measures will be needed to meet the needs of the FLMAs. Agency staff will be best positioned to develop performance measures that both reflect high level agency goals, objectives and policies and the lower level needs of agency sections and subsections to effectively manage the asset for which they have responsibility.

**Step 2 – Identify agency-specific programmatic guidance.** Examples include the “Maintenance Level” scheme of the USFS and the “Maintenance Intensities” system of the Bureau of Land Management (BLM). Select the key candidate goals and objectives guidance that apply most directly to slope management. Review the results and select a small group of key asset characteristics or features that, taken together, will best represent both the condition of the slope assets and the efficacy of management activities that apply to the slopes. Examples:

USFS examples (see Chapter 5 [Setting Agency Specific Performance Goals] for additional detail):

- Slope condition ratings
- Road closure extent and frequency
- Average time to clear incident and reopen road

Potential BLM Performance Measures:

- System-wide (or region- or state-wide) aggregated slope condition ratings
- Number of lane-miles of roads with slopes in fair or better condition
- Condition of slopes at recreation sites
- Condition of unstable slopes adjacent to high-traffic trails and facilities

Make connection with management and especially planning groups to determine what information they need to incorporate knowledge of condition and performance of slopes and that will be useful for managing the agency's performance.

**Step 3 – Conduct desk-based inventory/survey of slope assets.** Documents and information may be found in agency design and construction records, maintenance and operations records, and using Google Earth, Google Street View, and aerial photography, among other sources. Prioritize slopes, road segments, corridors and other geographical units following agency policies and directives (e.g. lumping together similar maintenance level or use roads and trails as a first cut).

**Step 4 – Initiate development of database to collect inventory and condition-rating data and information.** Initiate development of GIS-based mapping scheme to communicate performance measures and condition rating data and information. Conduct development with full cooperation of IT staff to avoid later problems and conflicts with software, hardware and applications for data collection that may be incompatible with the agency computing system. Plan data collection and display in consultation with management, maintenance, and operations sections and especially planning groups to affirm the utility of the USMP as a decision-support tool. This USMP program includes the database scheme for agency adoption on multiple platforms.

**Step 5 – Conduct field inventory and survey following priorities set in Step 3.** Extensive inventories may require multiple years to collect and catalogue sites to the practical limit. Following a priority scheme will likely require overlap in inventory and condition rating activities. Provide flexibility in the program to conduct both tasks simultaneously to limit field work in low priority geographic areas. Load inventory data into the database and maps. This step may be combined with Step 6, below.

**Step 6 – Conduct condition ratings for slopes following priority scheme.** Utilize newly developed inventory with portable devices and application software to simplify and expedite field work. Expect detailed ratings of extensive portfolio of assets and large geographic areas to take multiple years (such as an entire agency or region). Geographically-limited condition assessments, such as at a single Park in the NPS system, may take only one season.

**Step 7 – Analyze initial condition ratings and assess utility of system.** Based upon an early initial period, assess the condition rating program. Consider ease of use, sufficiency of hardware and apps for the collection process, completeness and quality of collected data, ability to collect data in a timely manner sufficient to complete ratings to meet goals and objectives for the agency's USMP, and any other agency-specific factors. Determine if changes to the data

collection program are warranted and make the changes. Determine if changes are needed to the database and interfaces and make those changes.

**Step 8 – Continue condition ratings with reassessed database system, hardware and applications, and mapping software.** Continue data collection until first round of data for all prioritized assets are complete. Repeat condition ratings at regular intervals. Conduct condition ratings as needed to meet requirements of adverse unstable slope events. Load data as it is collected into the database. Recent statewide geotechnical asset management programs in Alaska and Montana have recommended 5-year rating intervals (Beckstrand et al., 2017a; Beckstrand et al., 2017b). Extreme weather events may also trigger emergency assessments on an as needed basis to help prioritize response activities. Each FLMA will need to weigh its policies, goals, business practices, corridor importance, and other factors in setting its re-rate interval.

**Step 9 – Track performance trends over time, assess performance results, re-assess USMP for needed changes to process.** Assess the change trends in performance, based upon the measures and indicators developed earlier. Communicate with management, maintenance and operations and planning units to determine their “customer” view of the program. Make changes to the program to improve utility to users. Changes may include revisions to rating system to change which attributes are rated; agency may find some are not useful and that new attributes may be needed. Note that changes to the forms and database fields may impact the ability to share maintenance and IT support through a multi-agency (IT) maintenance agreement. Other changes may include priority for asset ratings, changes to database, map format and content, and webpage and other communication methods, or changes to frequency of rating events. Coordinate with economic analysts to determine whether the decision-support aspects of the USMP have utility for the overall program.

**Step 10 – Communicate the Results.** Consider various means to communicate the results of the condition rating and performance monitoring both internally to management, maintenance and operations and planning, and externally through annual reports, performance dashboards and on-line project stories, social media and other means. Tailor your message to stakeholders, the public, legislators and funding groups, and other key audiences.(NCHRP, 2009).

### **Performance Goals and Objectives**

Performance Management is a means for transportation agencies to measure progress toward a goal. Performance measures are indicators of work performed and results achieved(NCHRP, 2006). Performance Management is an integral part of Transportation Asset Management programs and is used by transportation agencies to measure progress toward Federal, State, and agency goals and objectives, often set in legislation or acts.

For FLMAs, the statutes and agency goals and objectives supporting USMPs may include broad goals of safety, infrastructure condition, congestion reduction, and system reliability resilience, as well as agency-specific goals depending on the types of assets concerned and the difference



between agencies(Landslide Technology, 2015). Guidance on these goals and objectives may be found in a variety of agency long-range transportation plans or other asset management plans. These goals, objectives, and policies provide the basis for appropriate investment decisions based in part on system performance and condition. Chapter 5 in this report describes examples on how to use and set performance measures, using the U.S. Forest Service’s road maintenance levels as the management framework.

Performance measures are the quantitative indicators of the service provided by the agency’s transportation system to the user.(Gordon, et al., 2011). The performance measures (and more specific key performance indicators) range from high level generalized agency-wide aspirational “management” goals to asset-specific “condition” goals. Examples of the former could include reducing the number of traffic fatalities and reducing cost of maintenance or reducing the number of structurally deficient bridges as measured by deck area. Condition goals could include improving the condition of rock slopes on a specific road corridor from poor to fair as expressed in percent of slopes reaching a specific level in a condition-rating scheme.

For FLMA USMP, “management” performance measures track how well the agency is managing and improving its unstable slopes over time. Using data from slope rating and maintenance activities, an agency can track the expected decrease of repairs, road closures, etc. over time. Agencies should expect that many years can pass before observing a marked decrease in maintenance and other costs and a related increase in system resiliency and performance improvements.

The performance measures and monitoring provide a method to develop an optimal investment plan and measure progress in moving toward strategic system goals. Agency adherence to performance measures derived from goals, objectives and policies lead to improved performance, reduced cost, improved safety, and other benefits.

## **Corridor Selection**

Developing and implementing a USMP program within an agency does not necessarily begin with a comprehensive, system-wide inventory and condition assessment. The program’s initial goals and focus may concentrate on certain corridors or management areas that have particular significance to the FLMA. These corridor selection criteria can focus on factors such as existing road classifications, mobility and safety risk factors, roadway modernization corridors, or other economic factors.

### ***Existing Road Classification***

Many FLMAs and DOTs currently subdivide their road systems with unique classifications, typically based on their intended function. The Forest Service utilizes a Maintenance Level scale subdivided into five levels(US Forest Service, 2009). State highway departments typically have two systems, a Functional Classification (Interstates, Primary or Secondary Arterial, Local Routes, etc.) and a Highway System Designation (National Highway Systems, State Highway System, etc.). FLMAs can use the existing classifications, which have already been designed to

fit with the agencies' goals and objectives. For instance, the Forest Service may opt to first inventory slopes on a road classified as Maintenance Level 5, its highest expectation of performance. State highway systems may opt to inventory Interstate and Primary Arterials on the National Highway System as the first set.

### ***Mobility and Safety Risk Factors***

These risk factors can be primarily tied to the frequency that people are susceptible to the hazard posed by the slope, which is roughly equivalent to average annual daily traffic. If the FLMA tracks traffic volumes, a cut off volume can be established where corridors above the determined volume are assessed and those below are deferred. Existing policies of the FLMA or percentile volumes (e.g. 75% of network volume is carried on 10% of the road network) offer a reasonable basis to develop cut off volumes.

Mobility and safety risks resulting from slope failures will be present where unstable slopes exist. Even though the FLMA has not carried out a comprehensive assessment at this early stage, experienced maintenance and geotechnical personnel are still likely to have a good mental map of where these issues exist. This experiential-based assessment of "known" unstable slopes can serve as a good 'common-sense' starting point for a focused inventory and condition assessment.

Mobility risk factors are also tied to the availability of alternate routes in the event of a road closure. The presence of a short detour (for example, less than 15 minutes added to travel time) will reduce mobility risk factors, while long detours or routes where detours are not available will increase risk costs. The FLMA can analyze or judge its road network for locations where these routes may exist.

### ***Roadway Improvement Corridors***

Roadway projects focused on improving safety and roadway geometry take years to develop and design. It is critical to provide geotechnical input in the early stages of these major improvement projects. For example, it is useful to focus inventory and condition evaluations in these study corridors so proper environmental clearances can be obtained early in the process. This action will permit improvement of the poorly performing assets where additional right-of-way or impact areas can be identified and addressed. Slope evaluations will provide credibility that they pose a risk to the FLMA and public and warrant inclusion in the project, just as corridor improvement projects often correct known bridge defects. Another advantage is to prioritize the highly rated unstable slopes and conduct a cost/benefit analysis and/or QRA to support selection of some unstable slopes for risk reduction in a given improvement corridor when funding levels are not available for immediate implementation but a plan for future investment is needed for proactive funding requests and managing the unstable slope assets.

### ***Inventory/Desk Study***

A well-planned and executed desk inventory or desk study helps the FLMA focus resources and saves time in the field. The desk study should focus on a particular asset type (such as retaining

walls or unstable slopes); cover previously selected regions, routes, or corridors; and work towards compiling all available data on the chosen geotechnical asset type in the area.

The information used in the desk study comes from a variety of sources. This includes available as-built information, road- or trail-view data (either internally maintained by the department or accessible through Google Street View or similar), intelligent mining of maintenance cost records or other data sets that reflect events, and, if possible, surveys of relevant maintenance personnel to locate maintenance “hot spots,” and reviewing environmental, cultural, and right-of-way maps with the appropriate specialists to locate potential habitat, cultural, or adjacent property owner concerns in the transportation corridors that will be rated.

Final products of the desk study should include, at a minimum, a summary of what is known about current assets and a geo-database with initial asset location information. The data summary for the desk study assets will probably include information that cannot be obtained in the field, such as year of asset construction. During desk study design and work, bear in mind that the final dataset should be easily appended to the field assessment data, so that all asset data is ultimately located in a single file. This makes relevant data easy to find, and prevents accidental loss of data when the final asset data set is transferred within the agency or shared with other agencies.

### **Field Assessments**

Although a desk study provides valuable information, the core of an unstable slope management program is the field assessments. The work done in the field is used to verify the desk study, and is then incorporated into the performance measures used by agencies to manage their assets. Typical information collected in the field includes asset location, linear extents, and ratings over a variety of risk and hazard categories. Some of these hazard categories may be specific to a given failure type, while others may be general and applied to both rock and soil slopes.

The USMP field rating system is best utilized by engineering geologists and geotechnical engineers, but this system has been designed to be utilized by physical science educated personnel with a wide range of experience levels and should return total scores generally within a 10-20% range of each other. FLMA's may opt to utilize temporary positions staffed by geologic or engineering interns to populate the initial database for economic and/or educational purposes under the responsible charge of experienced geotechnical personnel for accuracy and reasonableness. If an unstable slope event causes injury and litigation follows, some of the legal benefits may not be realized if the work is not checked and verified by experienced geotechnical staff. Using ‘cutoff’ scores and the preliminary score ranges can serve as useful indicators for review by more experienced personnel. See Chapter 4 (Personnel to Perform Ratings) for additional discussion of personnel performing the ratings.

In the initial phase of USMP development, field assessments may require multiple weeks of work in a single season. In an established USMP program, field assessments should be conducted on a regular schedule, for example, every three to five years, to help capture corridor condition changes. Within an established program, additional ratings could be conducted on an

ad hoc basis to capture site-specific changes resulting from asset deterioration or risk reduction mitigation work, or new failures as a result of a significant event, such as an earthquake or prolonged storm event.

Field assessment work should be planned and personnel trained in conducting field ratings prior to going out to the field. Once in the field, inventory and rating data should be collected as comprehensively as possible. At every site, the rater should be able to conduct an initial rating with initial scores for all relevant categories, even if these initial scores are revised based on later interviews with maintenance personnel. The ratings and information should be incorporated into the existing desk study, and shared within the agency through a geospatially referenced file and dataset. These datasets can be mined for the data required to determine the performance measures used to guide programmatic-level planning and budgeting.

The slope ratings can be carried out prior to or following the commencement and collection of new slope events and maintenance tracking activities. There is a benefit in implementing these two tracking activities for a year or two to begin collecting uniform history information for informing the relevant slope rating categories, such as rockfall history. Once the slope ratings commence and site IDs are created, the slope events and maintenance tracking forms can be linked to the unique site IDs for assigning specific events and activities to each feature (similar to bridge numbers) for asset tracking and improved cost estimation.

Once the scope of asset inventorying and condition assessment is determined following the guidelines above, Chapter 4 provides thorough guidelines for setting up, preparing, and conducting the ratings. The rating category descriptions are listed in Appendix A and the rating forms are contained in Appendix B. Appendix C provides instructions on utilizing the digital forms on a desktop computer's web browser or using iOS or Android mobile devices.

### **Tracking Performance-Related Events**

Performance management systems for geotechnical assets require data to operate. Some of the data needed for the FLMA USMP have been collected in the past by the respective FLMA agencies and are stored in databases and paper archives. New data on present condition, and future data to support the USMP process, will be derived from three types of occurrences: 1) initial inventory and condition surveys, and tracking forms for 2) “geotechnical events” and, 3) “maintenance events.” The initial inventory and condition surveys have their own standardized procedures and forms for FLMA agencies discussed elsewhere in this report.

For purposes of the tracking forms, a “geotechnical event” is typically considered a process resulting in a slope failure that is not the result of close proximity, in time or distance, construction or maintenance activities. This type of event represents an opportunity to collect data about the effect of these processes affecting slope assets and the current condition of an agency's geotechnical assets. A “maintenance event” is an activity initiated by an agency, either planned and scheduled or arising because of a situation or condition that requires an unplanned response. The maintenance event provides a chance to collect detailed data about the performance of a slope asset and costs of operating and maintaining a slope. Both types of

events give rise to data useful for performance management programs when it is readily available in an agency database.

The objective of using forms and standardized procedures for recording data about geotechnical events and maintenance activities is to ensure success in collecting and analyzing complete and accurate data sets so the information is most useful in supporting decision-making processes for agencies. The location, occurrence dates, and severity of events will help agencies pinpoint areas of concern. The area of concern may be a specific site that has a high risk to users or it may be a broader area that is causing higher than expected maintenance costs. Also, the data from tracking maintenance costs is the basis for computing the life cycle cost of slope assets over time. The collected condition data can be analyzed to determine trends in the deterioration rate of slopes and appurtenances such as rockfall barriers, in order to make the best decisions about priority setting and resource allocation for maintenance, repair and eventual reconstruction and/or road realignment of slope assets. Collection of data over time about these events provides a baseline of data about size and cause of events, condition of slopes, frequency of occurrence, and other factors that can be utilized to make forecasts about future condition, cost to maintain and repair, and other planning needs. The ability to forecast future costs and conditions will be a significant aid to agency decision-making about priority setting and resource allocation.

### ***Tracking New Geotechnical Events***

Geotechnical events are recorded in the “New Slope Event” form. A geotechnical event is an event such as a landslide or a rockfall that may range in severity from a nuisance (such as filling a ditch with soil, rock or other debris, but leaving roadway or trail open) to a catastrophic failure that closes a road or trail for a lengthy period before the damage can be repaired and the hazard mitigated. The event may be triggered solely from natural processes such as a heavy rainfall event or earthquake. These events may also be caused in part by human activity such as creating over-steepened cut slopes, construction activity altering drainage patterns, or simply the presence of the roadway embankment loading a marginally stable landslide. Whatever the source, these events are the primary target of the FLMA USMP. The collective FLMA agencies have goals to reduce risk, reduce cost and improve performance of their transportation systems. For the USMP, this means identifying slopes, analyzing their physical characteristics, and assessing slope life cycle cost and other economic factors (both benefits and costs), followed by planning maintenance, repair and replacement activities, all based on data collected for geotechnical events and for maintenance activities. The data are needed by agencies to achieve a transparent decision support tool for the decision-making process for maintenance, repair and replacement of slope assets.

The “New Slope Event” form was developed to provide guidance for data collection methods and procedures, along with data collection forms for this project. This form can be used to collect data about geotechnical events including rockfall, landslides, and snow avalanches. It provides for a slope identification tag, location information (both GIS identifiers and a point on a GIS map), route ID, type of event, and photographs. The form then provides check boxes for specific information on size and volume, description of the event, possible causes, and injuries or

damage from the event. Data from the forms are intended to be promptly uploaded to the agency's database – either in the field at the time of collection through an internet connection or from a desktop computer once the recorder/observer has returned from the field. Android and iOS applications facilitate data collection and storage. Management, geotechnical staff and planning staff will then have up-to-date data and information about agency-managed slopes. If preferred, a paper version of the form is contained in Appendix B.

### ***Tracking Maintenance Activities***

As noted above, the performance management system for the FLMA USMP requires data to support decision-making. Maintenance data are a key part of the data that supports decisions about maintaining, repairing and, eventually, reducing the risk or mitigating the risk of unstable slopes. Often, transportation field personnel across the country record data by hand to diaries or journals, including the types of problems, location, crew hours and equipment hours needed to address issues. These records are not always complete and generally do not yield the kind of data needed for thorough support of a USMP. Sometimes these handwritten records are transcribed and entered into a Maintenance Management System (MMS), but not always. Additionally, the records are rarely detailed enough to provide much of the information needed to support analysis for performance management. Typical transportation agencies collect little direct data about slope assets. Some MMS databases have one or two job activity codes that relate to rockfall or slope stability problems, but the personnel often collect several different kinds of activity under one code, making it difficult to separate out specific actions. For example, maintenance forces may record hours for “clearing debris from the road” that includes hauling away rocks that fell from a slope, trees that fell on the road, animal carcasses, and garbage. Much of this data is useless in terms of managing performance for slopes. Where existing MMSs are in place, they can be revised to include more specific codes to effectively characterize maintenance costs.

A better means of supporting the USMP is to employ an easy-to-use “Maintenance Tracking Form” accessible through the USMP website or on a mobile application. This form is intended to be a simple-to-use form that records data about agency-initiated maintenance activities. Maintenance events might be a routine planned activity, such as ditch cleaning, or an unplanned mitigation/repair of a slope that is about to or has already failed. These events may occur either in concert with planned, periodic maintenance activities or as an ad hoc activity occasioned by events such as failures due to a significant weather event. Whatever the nature of the activity, it is an opportunity for the agency to collect inventory and condition data about the site or sites and enter the data into the USMP system to support analysis and decision-making.

The data in the Maintenance Tracking Form include agency-specific location data about land unit designation, route or trail number (usually with mile markers), and type of event and cost data for personnel and equipment charges from a menu of activity types for hauling debris, bringing in patching materials, and other items such as gravel and asphalt patching material, rockfall barrier parts or draped netting. The total estimated cost of the maintenance activity is recorded along with the cost of each aspect of the maintenance event as a percentage of the total

work associated with a specific maintenance activity. The reporter/observer should also note whether agency forces are in use or contractors or both, among other information. This data can be recorded on paper forms or using the iOS and Android applications. Data from the paper forms are intended to be promptly uploaded to the agency's database – either in the field at the time of collection through an internet connection or from a desktop computer once the recorder/observer has returned from the field. If preferred, a paper version of the form is provided in Appendix B.

The maintenance tracking form data can be shared with an existing agency database through a correlating window on the form named, “Facility Index Code Relationship/Job Code Tracking (Optional).” This allows the data to be uploaded to an existing agency maintenance database once the fields have been created in the agency database to accommodate the USMP maintenance tracking form information.

### **Quantitative Risk Analysis**

Quantitative risk analysis (QRA) is another decision-support tool inside the larger USMP. In the context of unstable slopes, QRA uses measured or estimated numeric factors contributing to risk to assess risk probability and compare assessed risk with other societal risks. The purpose of the QRA is to compare estimated risk at any unstable slope site with other societal risks. This is useful if USMP ratings have not been done adjacent to the slope in question to provide a risk estimate independent from other USMP ratings, or as a prioritization tool on a subset of rated slopes to help prioritize them and put them in a “perceived” societal hazard context. In any discussion of risk, it is important to note the different meanings of the terms hazard and risk. Hazard is defined as something that poses a theoretical risk of harm to life, health, property or environment. Risk, on the other hand, takes into account the probability of occurrence and the consequence if the hazard is realized (Holmes, et al., 2012). Slope ratings use hazard and risk components to develop a numeric rating, but the QRA focuses specifically on estimating risk probability using factors about the hazard and the consequence that can be measured or estimated.

The value of using a quantitative estimate, such as the QRA, is that the assessed risk can be put in context with other societal risks. Such risk statistics are compiled by agencies such as the National Oceanic and Atmospheric Administration (NOAA), the Centers for Disease Control and Prevention (CDC), insurance agencies, and various FLMAs. A quantitative risk estimate is only as accurate as the factors that go into the estimate and other parts of the USMP can greatly inform a QRA, especially the ability to systematically track frequency of unstable slope events. Conducting a QRA can support benefit/cost analysis or help differentiate similarly rated slopes by focusing on exposure to the hazard.

### **Benefit/Cost Calculations**

The final step in implementing the USMP is the application of benefit/cost analysis in the long-term planning process. These analyses integrate the data collected in previous steps (such as asset condition and corridor importance) into a single metric allowing straightforward and

defensible project prioritization. The need for this prioritization arises from funding limitations faced by every agency, where the total cost of all deserving projects almost always exceeds the available funds. Benefit/cost calculations enable planners to consistently determine the maximum benefit achievable for a given amount of funding based, of course, on the quality and comprehensiveness of data in the asset management database. In a final list of projects, the projects that provide maximum benefit for minimum funding will be prioritized when allocating budget resources. The general form of the benefit/cost priority formula is:

$$\frac{\textit{Benefit}}{\textit{Cost}} = \frac{[\textit{Life cycle agency benefit}] + [\textit{Risk reduction user benefit}]}{[\textit{Project cost}]}$$

The life-cycle agency benefit is a combination of the life-cycle benefit, the recovery benefit and the environmental benefit of addressing geotechnical instabilities at a given site. The life-cycle benefit is a function of condition state and slope size since slope maintenance and eventual replacement generally becomes more expensive with size and over the passage of time. The recovery benefit represents the savings to the department or agency in decreased maintenance/event response costs. The environmental benefit assigns a monetary value to additional non-transportation benefits, such as reducing siltation in sensitive streams or preventing damage to culturally sensitive sites due to rockfall or landslides. The user benefit is a combination of the mobility and safety benefits. Both user benefits are tied to risk, and are frequently presented as the annual likelihood of an adverse event and the probable impacts of that event. Potential user mobility impacts include increased travel distances and time, or the complete inability of travelers to reach their desired destinations. The safety impact term estimates damages from accidents, typically providing a per-accident average cost that includes both injury and non-injury accidents.

When these cost and benefit concepts are quantified and applied in an objective and consistent manner, the agency will be provided with a relatively simple tool for use in multiple aspects of decision support. When making funding decisions, however, the agency should document any assumptions or estimates made when calculating benefits and costs. Initial costs and benefits should be refined by more detailed studies during the planning process, which may lead to funding allocation adjustments.

The benefit/cost approach to decision making is discussed in detail in Appendix D and in Chapter 6, which summarize the current state of practice, basic principles, and factors for consideration. Four alternative methods for calculating cost/benefit ratios have also been developed for integration in the FLMA program, and the advantages and disadvantages of each alternative are discussed. When making network-wide decisions, an FLMA should utilize only one approach that best suits its data availability, to ensure consistency. On a more limited basis (such as selecting between only four slopes or selecting slopes in a specific corridor) alternative benefit/cost options may be utilized depending on data. Using these alternatives, ten example sites from the Gifford-Pinchot National Forest in southwest Washington State are prioritized for mitigation using a cost benefit approach. Appendix E contains detailed information on these approaches for these sites.



## **CHAPTER 4. HOW TO CONDUCT FIELD RATINGS**

To obtain high quality data for use in geotechnical asset management work, field ratings must be performed by qualified and/or trained personnel using repeatable methods. The following sections describe the basic guidelines needed to conduct field ratings of unstable slopes.

Detailed category descriptions for each rating field are contained in Appendix A. All forms for rating slopes, tracking unstable slope “geotechnical” events, their related maintenance activities, and a sample conceptual design and cost estimation form are contained in Appendix B.

### **UNSTABLE SLOPE RATING CATEGORY DESCRIPTIONS**

The unstable slope rating category descriptions fall into three groups: preliminary rating categories, detailed hazard rating categories, and detailed risk rating categories. All sites identified for potential inclusion in the FLMA unstable slopes database receive a preliminary rating. If a site’s preliminary rating score falls above the given agency cutoff, then the site will also receive detailed hazard and risk ratings. Cutoff scores may vary between agencies, based on internal practices and public expectations.

The detailed hazard ratings seek to assess the general likelihood of an adverse event occurring at a given site. In general, the larger and more active a site is, the more likely it is to require unplanned and potentially extensive maintenance attention. For both rockfalls and landslides, slopes are scored over nine hazard categories, for a total possible hazard rating of 767 points. Three hazard rating categories are the same for soil and rock slope assets: slope drainage, annual rainfall, and slope height/axial length. However, due to the different failure types for rock slopes and soil slopes, the remaining six rating categories differ between the two asset types. For landslides and erosion failures, the remaining hazard categories describe the roadway or trail width affected, landslide/erosion effects, roadway or trail length affected, thaw stability, instability related maintenance frequency, and movement history. For rockfalls, the remaining hazard categories describe ditch effectiveness, rockfall history, rockfall event size, rockfall related maintenance frequency, and geologic character.

The detailed risk ratings seek to describe the potential impacts of an adverse event on the travelling public, the agency, and the environment if an adverse event should occur. There are nine detailed risk rating categories, for a total possible score of 805. The risk rating categories are the same for all unstable slope types.

Brief rating category descriptions are provided on the paper and digital rating forms. However, these descriptions are for quick reference only, and do not replace the detailed rating category descriptions provided in Appendix A. Those performing the assessments are encouraged to review the detailed rating category descriptions and review the “How to Rate an Unstable Slope” video prior to the start of fieldwork, so that any potential sources of confusion are identified and addressed. If possible, a copy of the detailed rating categories should be included in the field equipment for reference.

## **PERSONNEL TO PERFORM RATINGS**

The field ratings should ideally be conducted by experienced engineering geologists or geotechnical engineers. Raters with expertise in these fields are best able to assess probable failure mechanisms, event volumes, and event frequencies based on field observations. However, some agencies have found success training geology, geotechnical engineering, or applied physical sciences university students for ratings, with experienced personnel supervising condition assessments and under their responsible charge. Ideally, ratings will be conducted by a two-person team. Use of a team simplifies measurements and increases safety working around potentially unstable slopes. Furthermore, a more experienced rater can train someone less experienced during the field rating work. Field ratings can be completed by agency personnel, or by an outside professional if other constraints prevent a FLMA from conducting field assessments internally. While conducting site assessments, personnel should be physically able to stand for extended periods of time and to navigate the irregular surfaces potentially created by unstable slope events, while being situationally aware of safety hazards posed by slopes, narrow shoulders, and potentially inattentive drivers. Safety precautions set by each agency should be strictly followed at all times.

## **EQUIPMENT LIST**

Rating personnel should pack the following items when conducting field assessments:

- All relevant safety gear. At a minimum, this should include a high-visibility, reflective safety vest for any work conducted along roadways. It may also be prudent to wear a hardhat in areas prone to active rockfall or falling tree limbs on a landslide. Along high-traffic routes, traffic control and/or temporary signing may be required.
- A camera, preferably GPS-enabled, for taking site photographs.
- A handheld GPS unit for recording slope beginning and endpoints.
- Laser range-finder for quickly measuring slope heights, ditch dimensions, and related characteristics.
- A measuring tape for obtaining dimensions of blocks in the roadside rockfall catchment ditch, offsets along cracks in asphalt, and other measurements.
- A measuring wheel for obtaining slope lengths and site distances (back up equipment to a range finder).
- Laptop computer, tablet, or other device capable of running the appropriate software for field data collection.
- Paper field rating forms, even if for backup only. Binding the forms will help keep them organized and help prevent loss. Water-resistant paper will also be useful in inclement weather.
- A calculator for completing the rating equations in the paper field forms. This is automated in the software applications.

- A copy of the Detailed Unstable Slope Rating Category Descriptions (Appendix A), for use as a reference in the field. Again, water-resistant paper will also be useful in inclement weather.

Additional items that may be helpful during rating work are wet-weather gear, spare batteries, and maps of the area. These are not required to conduct field ratings, but help speed and simplify rating work. Certain items, such as the device capable of running geo-database software may not be included in the final field equipment list, at the FLMA's discretion. However, if the goal is to create a geospatially referenced dataset, creating this geospatial file as a back up to the field rating work is highly recommended, both to improve project efficiency and to help prevent possible location errors.

## **PLANNING**

### **Safety**

Personnel safety during field rating work is a concern that should be incorporated into the planning process from the beginning. Safety requirements may vary depending on where rating activities are to take place, and modifications to safety precautions may be required over the course of field assessment work, as raters move between corridors. Because safety precautions can vary extensively based on where the evaluated assets are located, reasonable safety procedures should be developed on a corridor-specific basis as field inventory work begins and adaptability of these safety procedures need to consider traffic volumes changing seasonally on federal land transportation routes.

### **Corridor Selection**

Selection of corridors prior to the start of field assessment work allows the agency to focus scarce dollars on areas of particular concern. Selecting corridors in advance also enables field raters to obtain required external data, such as economic or recreational importance of the corridor, prior to starting field assessment work. Possible criteria to assist in selecting corridors are described in Chapter 3 (Steps/Corridor Selection) above, but additional criteria may be generated for each FLMA or by a regional entity within the FLMA. Once chosen, obtain maps of the corridors, then develop an informal database, such as a spreadsheet, to track corridors selected for asset inventory work and those where evaluation will either be deferred or not completed.

### **IT Database Procedures**

Asset management is only useful if sufficient data are available to agency planners. To meet this need and others, the data collected during field rating work should be incorporated into a database that is easily accessible by agency personnel. The database developed as part of this program is exportable into an open format (comma separated values, .csv) that permits data to be incorporated into a variety of text and geo-database formats. The FLMA USMP database is searchable so that planners can look for unstable slopes under a variety of criteria, such as

location, failure type, condition state, or by scores in specific rating categories. The database and its searching and reporting functions are described in Appendix C.

All new data, whether collected using paper forms or entered directly into a field database, should undergo a QA/QC process upon returning to the office, and then the new data should be imported into the master database. An agency may wish to designate a single individual as the contact responsible for overseeing the addition of new data to the database, and for assisting in global changes to data (such as new traffic or trail counts) in the system, the generation of reports, or extraction of other information.

### **Using Forms**

When conducting fieldwork, raters can use either paper or digital forms. Both types have distinct strengths and weaknesses, as discussed below.

Well-designed paper field rating forms are easy to use and work well under a variety of conditions. They are easy to transport and, if printed on appropriate paper, useable under all weather conditions. If multiple sites are being evaluated, the paper forms should be bound into a booklet, to avoid the loss of any single sheet. If the corridor to be evaluated is known in advance, external data, such as annual daily traffic counts, can be added to the paper sheets before leaving for the field. During fieldwork, the rater should bring a calculator for evaluating those rating categories that are directly measured and scored. Calculating scores in the field is recommended to verify field measurements and to evaluate the need for additional site checks before departing a site.

The central weakness of the paper forms is that the rater is required to manually enter calculated category scores and data from external sources. Manually entering this data onto the paper form and later manually entering it in the database increases the risk of transcription errors and is less efficient. However, this problem is addressed through implementing a QA/QC program that double checks field notes and electronic transcription. Ideally, completed paper forms should be scanned and uploaded to a central location once rating work is repeated, so that they can easily be accessed and referred to as necessary.

Use of digital forms simplifies many data input issues, but requires that field raters have access to a laptop or handheld device during field work. Outdoor screen brightness settings and GPS usage can drain device batteries. The user should learn and implement battery preservation methods, such as dimming the screen; screen timeouts; and turning off Wi-Fi, Bluetooth®, and cellular network connectivity when without an expectation of connection. Connecting to vehicle power sources and/or spare battery packs will likely be required for prolonged field use. Digital forms have been designed such that the layout is as similar as possible to the paper forms, so that raters can alternate between the two formats as project locations dictate. All forms are contained in Appendix B of this manual.

## USMP WEBSITE AND MOBILE APPLICATIONS

The USMP website and mobile applications provide an interface to add information into the USMP database, as well as to search and retrieve information from the USMP database. Access to the USMP website (<https://usmp.info/>) requires a username and password, for security purposes. The user will see the navigation bar shown in Figure 3 after logging in.

A new slope rating form can be started by clicking on “Slope Rating Form” in the navigation bar. Information about the slope can be input using various entry methods (dropdown menus, radial buttons and open dialogue boxes). Information is stored in the database by clicking the “Submit” button near the bottom of the page. Submitted information is saved in the USMP database. A similar process is used to submit data on the “New Slope Event” and “Maintenance Form,” both of which are also found in the navigation bar.



Source: FHWA

**Figure 3. Navigation Bar for USMP Website and Mobile Applications.**

The USMP website also provides an interface to search and retrieve information from the USMP database. The search functionality can be accessed by clicking on “Map” in the navigation bar. A dropdown menu is located at the top of the page, just above the map. Searches can be made in any of the datasets associated with one of three information sources shown in Figure 4. Once one of these is selected, the user will have the option to select from three main search criteria to narrow the search. Results from the search are shown graphically on the map and/or exported to a comma-separated values (.CSV) file. Step-by-step instructions for creating/submitting forms and for performing a search can be found in Appendix C.

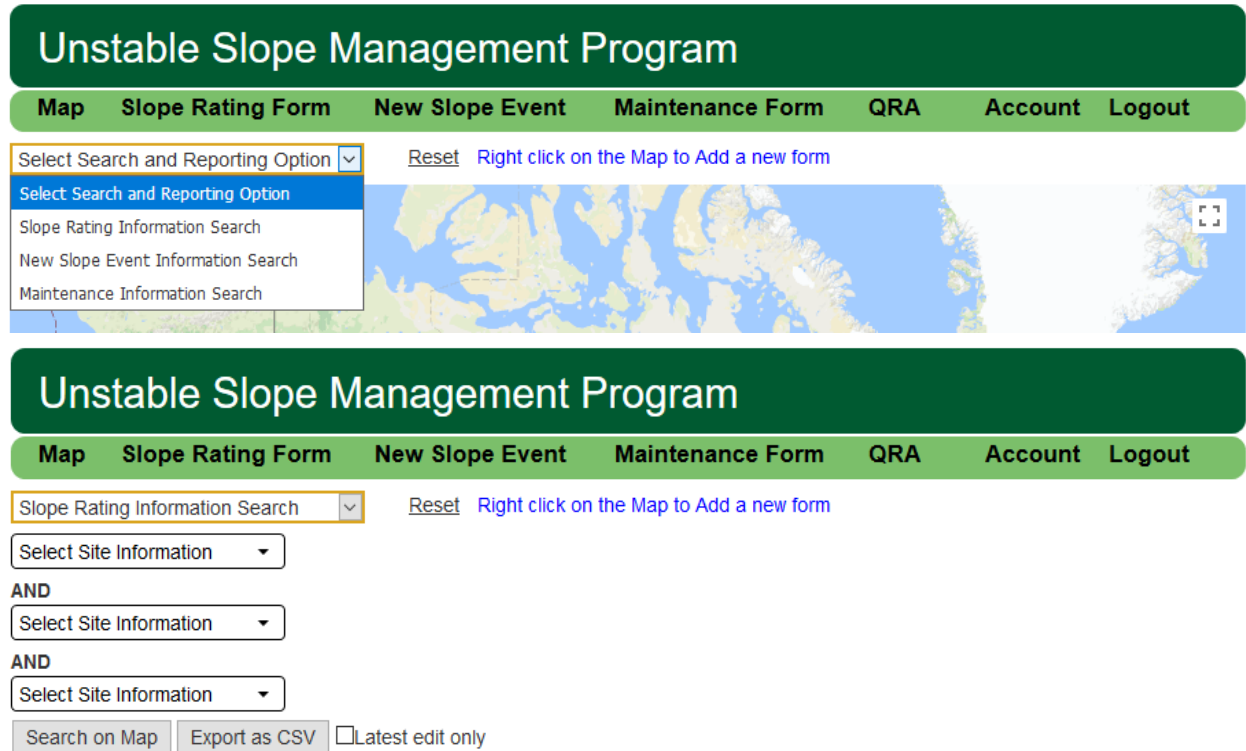

Source: FHWA

**Figure 4. USMP Searching and Reporting Interface**

Mobile applications were also developed for iOS and Android platforms. Login information is the same between the website and the mobile applications. Apps provide similar functionalities as those available in the USMP website, but are more convenient to use on smaller tablets and handheld devices in the field.

Users can create new sites while they are offline by creating new forms accessible via the navigation bar, similar to the process on the USMP website. Information entered in these forms will be stored in the mobile device when the user is offline and then can be submitted (one at a time) to the USMP database when the user returns to connectivity with Internet service. Additional information about the use of the mobile applications is in Appendix C.

## CHAPTER 5. HOW TO SET AND USE PERFORMANCE MEASURES

Performance management is a way for transportation agencies to measure progress toward a goal. Performance measures are indicators of work performed and results achieved (NCHRP, 2006). Performance management is an integral part of Transportation Asset Management programs and is used by transportation agencies to measure progress toward Federal, State, and department or agency goals, as well as objectives set in legislation or acts. In the current Federal rules, agencies have significant flexibility in how they implement performance management for assets other than bridges and pavements. This flexibility will permit testing and refinement of performance measures as agencies gain experience with implementing the USMP system, thereby providing a stronger footing for eventual inclusion in agency-wide TAM plans. The summary below is expanded upon in Appendix F.

Performance measures (PMs) are a critical component of asset management for slopes. PMs are the means by which transportation related agencies measure their progress toward goals and objectives. Performance measures come in a variety of forms. The first unstable slope PMs were developed as part of the AKDOT&PF GAM program and were tied to Levels of Service as targets (Stanley & Pierson, 2011; Stanley & Pierson, 2012). These initial PMs were qualitative targets and measures. Measures developed for the FLMA have further advanced GAM principles and have moved the PMs to a more quantitative format.

Key high-level performance measures, such as number of fatalities, bridge condition and congestion goals, are often shared with stakeholders and the public through public reports and web pages. A frequently-used method for web reporting is the PM “dashboard” which gives a pictorial view of the agency’s performance, as shown in Figure 5. More detailed, and specific PMs, such as those needed for programs like the USMP for FLMA, may be internal to the agency staff or may be shared by grouping many PM results into a few or even a single performance measure for public sharing. It may be useful for agency officials, legislators, the public, and stakeholders such as user groups to know that 80% of the agency’s slopes statewide or region-wide are in “good” condition, or that only 8% of a region’s bridges are “structurally deficient.” However, much more detail is needed for agency staff to adequately manage a diverse group of assets across large geographic areas with highly variable conditions, topography, climate, geology, and nature of their use. The following sections provide guidance in how

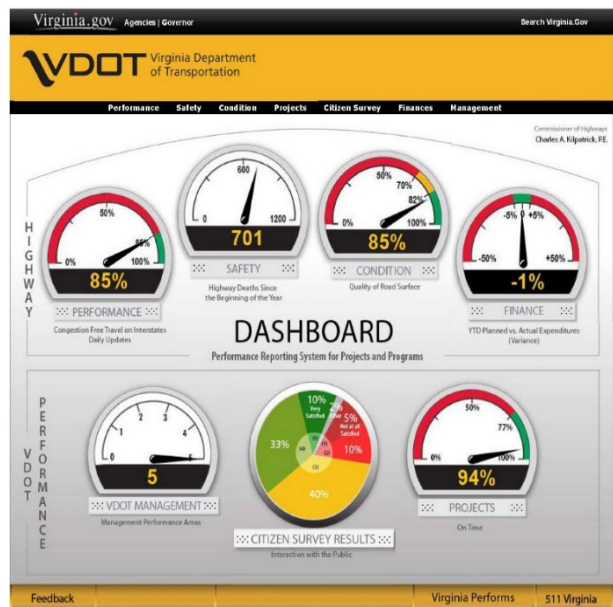

© VDOT

**Figure 5. Virginia DOT Performance Dashboard (VDOT website – accessed December 16, 2016)**

to create and execute a PM system to fit specific agency needs.

By inventorying and assessing all unstable slopes within a selected agency (or subset thereof), small, incremental improvements to the entire inventory can be tracked when maintenance is performed (such as ditch cleaning for rock slopes improving ditch effectiveness, which reduces the USMP score) or more significant improvements are made. For example, consider the hypothetical situation where an agency has 2 million square feet of ‘Poor’ condition rock slopes out of a total inventory of 10 million square feet. Five million square feet are in ‘Fair’ condition and the remaining area is in ‘Good’ condition. resulting in a 30/50/20 split between Good/Fair/Poor categories, respectively. A five-year plan has a combination of scaling and ditch improvements planned for 200,000 square feet of ‘Poor’ rock slopes to improve their condition to ‘Fair’. In this scenario, an additional 300,000 square feet of ‘Fair’ slopes will be improved to ‘Good’ through an associated road realignment by significantly improving ditch effectiveness and utilizing the nearby rock slopes as an embankment fill material source. Ignoring the deterioration of untouched slopes, the final proportions of Good/Fair/Poor will be 33/49/18 after this five-year plan is carried out. This approach is very similar to how network pavement quality is tracked and reported through time.

## **IMPORTANCE OF TRACKING GEOTECHNICAL EVENTS**

Performance management systems require fuel to operate, and the fuel is data. For FLMA slopes, data are often a result of a “geotechnical event.” The occurrence of geotechnical events represents an opportunity to collect data useful for performance management programs. A geotechnical event may be defined as a slope failure event such as a rainfall-caused landslide or a rockfall. Record these event types in the New Slope Event Form described in Chapter 3 (Tracking Performance Related Events) and in Appendix B.

The event might be an agency-initiated planned event, like ditch maintenance, or an unplanned maintenance and operations repair of a slope failure and would be recorded in the Maintenance Tracking Form described in Chapter 3 (Tracking Performance Related Events) and Appendix B. The event may also be a sequence of slope rating activities such as conducting USMP inventory and condition assessments, either in a planned periodic sequence or as an ad hoc activity stimulated by a significant weather event, which would be tracked by the individual agency. Whatever the nature of the activity, it is an opportunity for the agency to collect inventory and condition data about the site or sites and enter the data into the USMP system.

Asset management depends on data, and managing data requires a database. The USMP for FLMAAs includes database tools, forms and mobile device applications for collecting data in the field and storing the data in the “agency” databases. Each agency has unique IT requirements and configurations, along with an agency-specific firewall and other security requirements and specifications for acceptable software and hardware. The individual agencies will control those details, but the important point is that a database is necessary along with an efficient means of collecting and storing data, then winnowing it down to extract information usable for managing slopes.



To date, the most useful platform for geotechnical asset management databases is web-based mapping tools that provide the end user with a scalable visual picture of the location and condition of individual assets, groups of assets of a type, and groups of differing assets. This type of deliverable also allows instant connection to backup information such as slope rating forms, spreadsheets and other tabular data, photos, drawings, incident reports, maintenance repair cost reports, geotechnical reports on a site or a corridor, condition ratings, benefit/cost calculations, mitigation strategy reports, and forecasts of condition and cost.

However, the mere amount of data collected can create problems over time if not carefully managed. It is critical for successful asset management programs to collect only the data needed to conduct management activities. Collecting the right data for the right asset at the right time reduces the amount of IT work necessary to populate and maintain a geotechnical database for asset management purposes. It is likely that valuable asset management data can be mined from existing agency databases. These issues can be addressed by keeping a data roadmap in mind. One recent summary classifies geotechnical data for asset management as consisting of road sections, corridors, elements (individual asset types) and past actions (history of construction and maintenance activities) (Thompson, et al., 2014). To accommodate the daunting array and quantity of data that can be generated in a performance-monitoring program, it is very desirable to develop a “data business plan” or “data governance plan” to address as many issues as possible at the outset of launching an asset management program. Guidance on this issue is available, starting with the TAM Guide in Section 8.4.2(Gordon, et al., 2011).

## **SETTING AGENCY-SPECIFIC PERFORMANCE GOALS**

Chapter 3 (Steps/Performance Goals and Objectives) and Appendix F of this document discuss sample performance measures (PMs) for a USMP for the U.S. Forest Service. Development of the PMs for the USFS built on a well-developed set of USFS guiding principles, goals and objectives to develop the program’s performance measures and key performance indicators. A critical factor in the utility of USFS’s plan is the agency’s established five-level “Maintenance Level” system. Level ML-1 is the lowest level and designated for roads that have been placed in “storage” and for which only minimal maintenance is conducted to prevent unplanned deterioration. Level ML-5 is the highest level and is used for roads that provide a high degree of user comfort and convenience. Most transportation corridors within Region 6 of the USFS are paved double lane roads expected to be passable by passenger cars. The research team created a set of PMs for a USFS USMP based on agency goals and objectives and the Maintenance Level system. The PMs include both management and condition performance measures and key performance indicators (refer to Appendix F for a detailed discussion on this topic).

The Bureau of Land Management, one of the collaborating agencies on this project, has already developed an asset management plan (Bureau of Land Management, 2009) and an inventory and condition assessment manual for roads (Bureau of Land Management, 2011). The 2009 Asset Management Plan divides the BLM’s transportation system into three modes: roads, primitive roads, and trails, as shown in Figure 6. The plan contains the key elements of a typical transportation asset management plan that can lead directly to creation of PMs for slopes along the transportation infrastructure. This document (H-9113-2) does not provide specific guidelines for rating unstable slopes, but USMP condition ratings could be incorporated into this preexisting framework. This would increase the speed of USMP rating adoption.

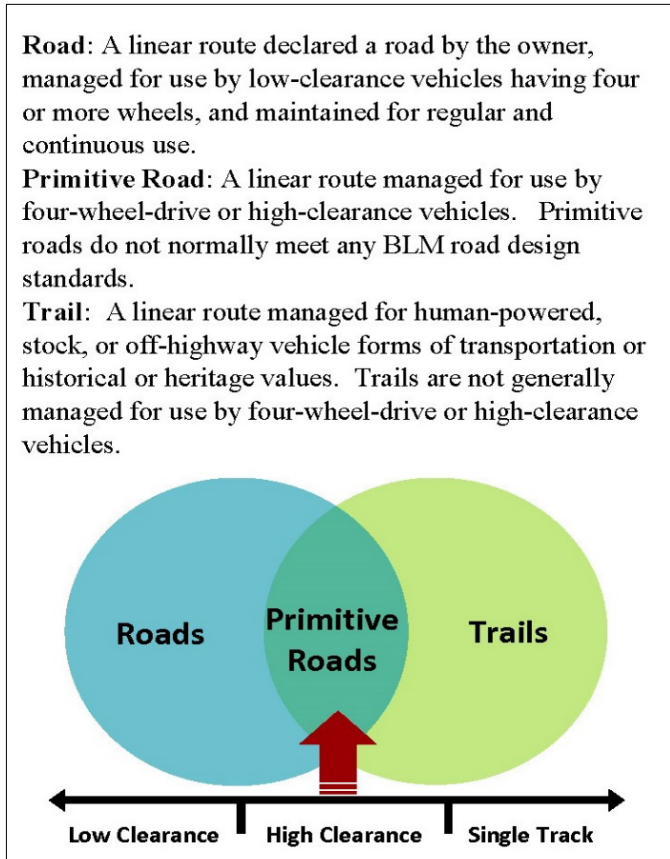

Source: BLM  
**Figure 6. BLM Transportation System Modes**

Additional backup documents include the BLM Manual, which has enumerated “Maintenance Intensities” very similar in nature to the USFS Maintenance Levels (see Section MS 9113-Roads of the BLM Manual). There is also a BLM Strategic Plan for Oregon and Washington that includes a priority for



Source: BLM  
**Figure 7. Landslide on a BLM road, southwest Oregon.**

improving processes and functions with a subtopic for “Program Investment for Travel and Transportation/Road Infrastructure.” Additionally, BLM has already developed decision support tools to prioritize spending, including the Asset Priority Index (API), Facility Condition Index (FCI) and Current Replacement Value (CRV), used in conjunction to develop a business plan for asset planning along with a deferred maintenance and a capital

improvement program. These taken together comprise a mature and extensive system for addressing asset management. BLM has an extensive set of performance measures already in place to track the progress of the asset management plan and business plan; one of which directly applies to the USMP. “Maintenance: Number of lane miles of roads maintained in adequate condition” applies to slopes such as shown in Figure 7, which can be assessed to determine if the roads are in an adequate condition or if unstable slopes pose a risk to mobility and maintenance (Bureau of Land Management, 2009).

In summary, for those FLMA agencies with strategic goals and organized, comprehensive programs to address the current and future condition, cost, and performance of their respective asset portfolios, it is possible to create a useful USMP program integrated in the agency’s existing asset management plan. Where goals and objectives are already in place it is possible to devise appropriate performance measures and metrics for tracking progress over time that are readily included in the existing agency management framework.

## **SLOPE CONDITION RATING AND PERFORMANCE MEASURES**

Chapter 4 of this report and Appendix F discuss slope ratings in detail. For the FLMA USMP, performance measures (PMs) connect the agency objectives, goals and policies with the performance metrics based on the slope condition rating system. PMs and key performance indicators (KPI) relate to an agency’s progress, as measured by the condition ratings, to improve the overall condition of an agency’s slopes. Large scale PMs may refer to an entire transportation system, a regional system, or in the case of the USFS, a national forest management unit such as the Gifford Pinchot National Forest. Small scale PMs or KPIs may refer to corridors within a national forest management unit, road segments of a corridor, or even individual slopes.

Performance measures, as noted above, may be “management” metrics or “condition” metrics. Management metrics tend to be less technical in nature and may include levels-of-service measures that reflect customer expectations about non-technical issues such as clarity of signage, extent of congestion, and could include, for example, perceived safety of travel past rock slopes in poor condition. These issues can be represented numerically, even though they are generally observational in nature.

Condition metrics may be more technical in nature, for example pavement rating systems that rely on measured characteristics of roughness and extent of cracking. For unstable slopes the condition rating is the heart of the USMP. Slope rating systems usually combine measurements of physical attributes, such as height of slope, width of ditch, sight distance and reports on traffic volume, as well as geotechnical measurements and observations of discontinuities, rock type, and degree of weathering. The individual scores are summed to make a combined score for an individual slope. The total preliminary score can be categorized in groups and can be expressed in a Good/Fair/Poor condition (Table 1), as is common in TAM systems. As repeated cycles of slope ratings are conducted, either on a schedule (i.e., every five years) or ad hoc rating periods

(such as after increased debris flows due to heavy rainfall), the originally assessed condition may change.

The Good/Fair/Poor system is adopted in FHWA funding legislation and accompanying regulations. The primary objectives for adopting a Good/Fair/Poor system are to define a consistent and reliable method for assessing infrastructure health and to help develop tools that will allow transportation agencies to get a better and more complete view of infrastructure health. Good/Fair/Poor classifications are defined based on the preliminary ratings as follows for the USMP, modeled after definitions for bridges and pavements (Guerre, et al., 2012).

**Table 1. Good, Fair, and Poor Classifications for USMP Slopes.**

Good Condition	Slope Asset is free of significant defects, and has a condition that does not adversely affect its performance. This level of condition typically only requires preventive maintenance activities such as routine, occasional ditch cleaning. <b>USMP Preliminary Scores are typically 15 to 21 points.</b>
Fair Condition	Slope Asset has minor deterioration, erosion/raveling of cut slope, rockslides or rockfall, or infrequent subsidence of the embankment slope. This level of condition typically could be addressed through maintenance or risk reduction mitigation efforts, such as installation of barriers at road level and draped mesh to direct rock to the ditch or occasional subgrade improvement/strengthening with asphalt patching and/or drainage improvements. <b>USMP Preliminary Scores are typically 22 to 161 points.</b>
Poor Condition	Slope Asset exhibits advanced deterioration and conditions that impact ability of slope to remain intact. This level of condition typically requires narrowing the roadway, risk reduction slope repair, rehabilitation, reconstruction or replacement. Potential mitigation may include robust barriers, draped or anchored wire mesh, landslide stabilization techniques such as horizontal drains or buttresses, or cable net to hold rock on slope or direct it to ditches. <b>USMP Preliminary Scores are typically &gt;161 points.</b>

### EXAMPLE OF PERFORMANCE MONITORING FOR U.S. FOREST SERVICE

Performance measures (PMs) were prepared as part of this project based on how well one of the participating FLMAs was maintaining its unstable slope assets and their contribution to the continued function of the road network. PMs were prepared using information from the US Forest Service based on its five-tier Maintenance Level road classification system.

An excellent example of a set of FLMA goals and objectives can be found in the document, “U.S. Forest Service Accomplishments FY2013 Federal Lands Transportation Program.” Additional information is found in the Forest Service Road Maintenance Management System (U.S. Forest Service, 2009). The goals and objectives are summarized below. These strategic priorities imply transportation objectives of safety, mobility, and protection of natural resources:

- Overall goals and objectives from investment strategy – maintain, preserve and, if possible, improve access to high priority areas.
- Specific goals and objectives:

- Ensure safe access.
- Reduce bridge deficiencies.
- Focus on high priority roads for maintenance and improvement.
- USFS strategic plan goals and priorities:
  - Facilitate outdoor recreation opportunities.
  - Enhance social, health, economic, etc. opportunities and experiences for visitors.
  - Provide seamless transportation access from public roads to USFS destinations.
  - Implement forest plans.
  - Improve rural economic opportunities.
  - Manage transportation to protect natural resources.

The draft Performance Measures prepared for the Forest Service utilize the USMP scoring system, geotechnical event trackers, and unstable slope maintenance trackers to assist with the documentation, analysis and determination of deteriorating, stagnant, or improving conditions on its road network. These performance measures are contained in Appendix F, with an example table filled in below with hypothetical performance data (Table 2).

**Table 2. Example Performance Measure Table for U.S. Forest Service (bold text indicates examples filled in).**

<b>Performance Measure. Maintain slope condition to applicable good-fair-poor service levels, as measured by road closing events. Where no unstable slopes exist, the slope ratings would be considered "Good".</b>	<b>Prev. Period Closure Freq. &amp; Density</b>	<b>Current Period Closure Freq. &amp; Density</b>	<b>Performance Target</b>	<b>Trend</b>
<u>ML-3:</u> Roads are open to standard passenger vehicles and shall remain open with application of normal maintenance routine. Occasional partial or full closures may result due to slope instability caused by deterioration and/or unusual conditions (e.g., heavy rainfall causing slope failures) that may require repair prioritization behind higher priority roads. Preventative maintenance is performed to reduce impacts over time. <b>Likelihood expressed as a per mile annual occurrence of closure.</b>	<b>2 closures over 17 miles 2005-2010 (2.3%)</b>	<b>5 closures over 17 miles 2010-2015 (5.9%)</b>	<1 per 3 years per 10 miles (3.3%)	<b>Worse, Met Target, then worsened</b>
<u>ML-4:</u> Roads are open to standard passenger vehicles and shall remain open with application of normal maintenance routine. Occasional partial or full closures may result due to slope instability caused by deterioration and/or unusual conditions (e.g., heavy rainfall causing slope failures) that may require repair prioritization behind higher priority roads. Preventative maintenance is performed to reduce impacts over time.	<b>1 closure over 9 miles 2005-2010 (2.2%)</b>	<b>1 closure over 9 miles 2010-2017 (1.6%)</b>	<1 per 3 years per 15 miles (2.2%)	<b>Better, Met Target &amp; more improvement</b>
<u>ML-5:</u> Highest priority roadways. Rare partial or full closures may result due to slope instability caused by deterioration and/or unusual conditions (e.g., heavy rainfall causing slope failures). Preventative maintenance is prioritized and performed to reduce impacts over time.	<b>3 closures over 30 miles 2002-2010 (1.3%)</b>	<b>2 closures over 30 miles 2010-2015 (1.3%)</b>	<1 per 5 years per 20 miles (1%)	<b>No change. Does not meet Target</b>

## **CHAPTER 6. HOW TO USE BENEFIT/COST APPROACHES**

The benefit/cost approaches formulated for this project present a series of alternative analyses for prioritization of slope preservation, risk reduction mitigation, and reconstruction. All of the approaches are based on widely accepted principles of risk management and asset management, with varying levels of data requirements. The approaches provide an objective and consistent means of summarizing the degree to which each project may contribute to agency objectives while minimizing long-term cost and risk. A full description of how to implement these techniques is summarized in Appendix D.

For agencies and asset classes that lack a history of data collection and sophisticated tools, the appropriate methods for geotechnical assets are much simpler than those that are commonly used for pavements and bridges. Nonetheless, the adoption of certain basic well-structured practices, relying on a systematic inventory and condition survey, can substantially enhance the consistency and objectivity of priority setting and resource allocation. This can reduce long-term costs and establish the groundwork for continuous improvement over time.

The need for prioritization and resource allocation arises because of limitations on funding. The list of attractive projects that need to be completed is usually costlier than can be accomplished with available funds. If two projects are expected to have the same benefit, then in principle the one with lower cost is given more priority. If two projects have the same cost, the one with higher benefit is given more priority. A list of projects sorted by benefit/cost ratio provides a consistent way to determine the maximum benefit that is achievable for any given amount of funding, and selects the list of projects that can achieve this high level of benefits.

To support the FLMA's in these management functions, four approaches were developed to assist in prioritizing and selecting projects to advance, using both national (i.e., encouraging the use of asset management principles on non-pavement and bridge assets to reduce long-term costs and improve system performance) and Forest Service-specific goals and objectives. Each approach is summarized below and detailed in Appendix D.

### **VARIOUS APPROACHES TO BENEFIT/COST CALCULATIONS**

As part of this manual, multiple methods have been developed for calculating benefit/cost ratios, based on the level of data available to the agency. In their purest form, benefit cost calculations incorporate life cycle costs, risk analyses, and site-specific risk reduction mitigation costs. Depending on data availability and desired level of detail, the basic formula can be simplified in a variety of ways. These options are summarized in the following subsections, and are described in detail in Appendix D. To illustrate how these various approaches can be applied to an existing data set, they are applied to a set of sites from the Gifford Pinchot National Forest later in this chapter.

## Alternative 1: Computed Benefits and Costs

If sufficient data are available for a given slope, the most precise estimate of benefit/cost ratio would fully utilize the formulas in Appendix D. Combining the life-cycle cost and risk components, the basic ratio would be:

$$\frac{B}{C} = \frac{\text{Life Cycle Benefit} + \text{Likelihood} \times \text{Consequence}}{\text{Initial Cost}}$$

The detailed equation in Appendix D allows any term to be replaced if more detailed information is available, such as an actual risk reduction mitigation cost estimate. The unit costs presented in Appendix D are initial order-of-magnitude estimates and can be improved over time through additional research, interviews, data mining of existing maintenance records, and tracking of future maintenance, risk reduction mitigation, and accident costs. The constants in the consequence equation are derived from AASHTO guidelines and can similarly be replaced if better estimates are available from analysis or judgment (AASHTO, 2010).

Data requirements for Alternative 1:

- Average daily traffic (for low-traffic critical roads, a minimum ADT could be assigned, or an ADT computed for the busiest months applied to capture seasonal traffic).
- Condition state (derived from USMP preliminary score).
- Detour length in miles.
- Detour time in hours, or detour speed in miles per hour (where no detour information is available, the analyst can make a rough estimate of average user costs in terms of dollars per vehicle, through a process described in Appendix D).
- Estimate of environmental cost of slope failure. Since there is no established methodology to compute this, it would generally be omitted unless a study has been done to quantify it; however, environmental costs are very important to the mission of many of the FLMAAs.
- Height of slope (for rock slopes).
- Length of slope along the road (for both slope types).

Advantages of Alternative 1:

- Offers the most precise estimate of benefits and costs.
- Recognizes the life cycle benefit of preservation, which may save money in the long term.
- Uses all available data.
- Contains the most reliable approach for defending programming decisions.

Disadvantage of Alternative 1:

- Requires more data than any alternate method.

## Alternative 2: Priority Index

For sites where the level of detail required by Alternative 1 is not available, a simplified expression can be used to develop a priority index, which is shown below:

$$\frac{B}{C} = \frac{Size \times A_{Ben\$} + Likelihood \times (18ADT + Size \times Rec\$)}{Size \times Cost\$}$$

In this index, detour information has been omitted, with the assumption that detour distances between the evaluated sites are relatively consistent or that the detour distances are immaterial to the affected roadway users. Since no detour information is included, it is best applied to sites within a single transportation corridor, and not used to compare sites where detour distance or overall availability vary widely. Other simplifications are listed below.

- Mobility benefits are directly correlated with safety impacts, with both dependent on the traffic volume and likelihood of service disruption based on site condition.
- The environmental benefits have been eliminated.
- Benefits and costs are no longer explicitly addressed.
- Dollar values of additional project impacts cannot be incorporated into the numerator or denominator.
- This simpler formula is not valid if no traffic exists on the road (for example, USFS Maintenance Level 1).

Data requirements for Alternative 2:

- Length of slope along the road.
- Height of slope (for rock slopes).
- Average daily traffic.
- Maintenance level.
- Condition state (derived from USMP preliminary score).

Advantages of Alternative 2:

- Simpler than computed costs and benefits.
- Moderate data requirements.
- Recognizes the life cycle benefit of preservation.

Disadvantages of Alternative 2:

- Does not account for sites with long detour routes, which may be problematic if these routes also have heavy traffic.
- Not able to incorporate additional site-specific information, such as an actual cost estimate.



### **Alternative 3: USMP Score Priority Index**

For sites with no economic data, a priority index can be developed based on total site rating, size, and average daily traffic. A higher USMP score indicates poorer slope condition and increased likelihood of service disruption. Greater slope size implies greater mitigation costs. Higher traffic volumes imply higher mobility and safety risk costs, as well as general importance of the corridor to the agency. The relationship of these three variables is captured in the following formula:

$$Priority\ index = USMP\ Score \times \frac{ADT}{Size}$$

where: size = slope size (approximated area for rock slopes or length of the road affected for landslides), and ADT = average daily traffic.

This alternative is known as a “worst-first” indicator because it does not consider life cycle costs. It is not able to assign a benefit to preservation actions. For critical roads with very low ADT, a minimum ADT value may be assigned. Similarly, for seasonal traffic, the index may be computed using average ADT for the busiest months.

Data requirements for Alternative 3:

- Length of slope along the road.
- Height and length of slope (for rock slopes).
- Average daily traffic.
- USMP total score.

Advantage of Alternative 3:

- Smallest additional data requirements.

Disadvantages of Alternative 3:

- Cannot consider preservation actions, ultimately producing more expensive programs.
- Does not account for maintenance and recovery costs.
- Does not account for sites with long detour routes, which may be problematic if these routes also have heavy traffic.
- Inability to incorporate additional site-specific information.
- Not compatible between asset classes.
- Unsuitable for resource allocation or computation of fiscally-constrained performance targets.
- More difficult to communicate results to users outside the geotechnical expertise area.

### **Alternative 4: Hybrid of Alternatives 1 and 2**

Alternatives 1 and 2 are mutually compatible because both use the same factors for scaling the benefit/cost ratio. Where the detailed mobility and environmental impact data required for

Alternative 1 (e.g., detour length, slowdown duration) are not available for all sites, but sufficient data are available to follow Alternative 2, both equations can be used within the same priority list. This is especially useful for agencies that have only partial coverage of some of the data items in the inventory. Alternative 1 would be used whenever possible, falling back on Alternative 2 when necessary.

Advantages of Alternative 4:

- Applicable to a partially completed database.
- Maximum soundness from an engineering and economic perspective.
- Most amenable to scenario analysis, such as considering fiscal alternatives and performance targets, because more of the inventory can be covered than in Alternative 1 alone.
- The approximate analysis using Alternative 2 can be used to prioritize additional data gathering for use in Alternative 1.

Disadvantages of Alternative 4:

- Comparing Alternative 1 to Alternative 2 sites may be problematic if sites have long detours.
- See disadvantages of Alternative 2.

## **SELECTING THE APPROPRIATE APPROACH**

The alternative that best suits a given data set is determined using the quality of the data available. Although site condition must be established with a field visit and associated rating, additional data, such as ADT and detour length, is obtained from other sources, and can be added or edited in the office. If risk reduction mitigation cost estimates are available for some sites, but potential mobility impacts are not, the missing data can be estimated using publicly available mapping software or agency sources.

Once the decision is made on how much to improve the data set before conducting cost/benefit analysis, the appropriate approach is the most detailed alternative for which all required data are available. If data are available for a computed cost/benefit analysis (Alternative 1), then presenting a USMP Score-Based Priority Index does a disservice to high-level planners seeking to allocate resources as effectively as possible. The various cost/benefits approaches are applied to a sample data set from the Gifford Pinchot National Forest in the last section of this chapter.

## **COST ESTIMATION**

Initial conceptual designs and cost estimates should be developed by experienced geotechnical engineers or engineering geologists during a field reconnaissance of the site. Because the development of a site-specific cost estimate requires more time than the typical 15-minute field-rating visit, sites should be selected for conceptual mitigation based on the ranked slope ratings by some set of criteria prior to heading out to conduct the field reconnaissance. Potential criteria include using a minimum USMP score or ADT count as a cutoff value, focusing on a specific

corridor and linking the extent of conceptual design and cost estimates to the overall corridor level of service set by the agency. Agencies may combine various selection criteria to best suits their needs.

An alternative programmatic approach would be to assign cost estimation that correlates to size and condition of the slope rather than conducting a site-specific conceptual design with cost estimates. The accuracy of the cost estimate is a controlling factor for data quality. Agencies may opt to generate network-wide estimates of improvement costs without expending the effort to gather site-specific cost estimates for hundreds of slopes. This approach has been used in some recent research projects (Beckstrand et al., 2017a; Beckstrand et al., 2017b) with cost estimates prepared from large data sets (Beckstrand et al., 2016; Pierson et al., 2005; Washington State Department of Transportation, 2010). These generalized estimates are very useful for long range programmatic level planning and have helped state DOTs better understand the value of their geotechnical assets. As described above, as additional or higher quality information becomes available, it can be replaced in many of the alternatives detailed in Appendix D.

When performing site-specific cost estimates, the conceptual designs themselves should be performed by experienced personnel who are capable of quickly and efficiently conducting a field reconnaissance. These estimators should have sufficient experience in risk reduction mitigation projects to be able to estimate likely costs for the various components selected to improve a given site. Because required mitigation work will become more extensive as slopes degrade, cost estimates should also be revisited at regular intervals of 5 to 10 years, similar to whatever interval the agency is applying to site inspections to review USMP ratings. Appendix B contains a form to help practitioners conceptualize designs and estimate costs.

## **EXAMPLES FROM GIFFORD PINCHOT NATIONAL FOREST**

Ten sites within the Gifford Pinchot National Forest were selected for initial cost estimate work. Instead of incorporating specific filtering criteria, a broad range of sites were intentionally selected for the conceptual mitigation work, with an equal number of rockfall and landslide sites. A two-person team composed of an engineering geologist and a geotechnical engineer visited each site, conducted a field reconnaissance, developed a conceptual mitigation design and associated quantities, and estimated project costs based on past experience and expert judgment. These cost estimates were then used in example applications of the various cost/benefit approaches, as described in the following section. Specific conceptual designs and cost estimates with USMP site ratings are contained in Appendix E.

In September 2014, Landslide Technology evaluated 126 sites along paved routes in Gifford Pinchot National Forest. Conceptual mitigation designs and costs were developed for 10 of these sites in June 2015. Ranked USMP site ratings for the 2014 work were submitted as part of the Task 1 memorandum. The site-specific USMP ratings and risk reduction mitigation estimates for the 10 sites used as cost/benefit examples are also compiled in Appendix E for review. An overview of the example sites and USMP site information used in the various benefit cost analyses alternatives is provided in Table 3 below.

**Table 3. Sites used in benefit/cost calculations with selected site information.**

Site	Hazard Type	ADT	Size (approx.)	USMP Score	Site Condition	Estimated Mitigation Cost	Est. Detour (mi.)*	Est. Detour Time (minutes)*
<b>FS 25 MP 29.44</b>	Landslide	450	260 ft	371	Poor	\$ 235,650	44.1	25
<b>FS 25 MP 24.70</b>	Landslide	450	125 ft	286	Poor	\$ 50,250	44.1	25
<b>FS 25 MP 24.45</b>	Landslide	450	168 ft	416	Poor	\$ 57,250	44.1	25
<b>FS 25 MP 25.15</b>	Landslide	450	175 ft	492	Poor	\$ 373,500	44.1	25
<b>FS 25 MP 28.33</b>	Landslide	450	115 ft	336	Poor	\$ 25,050	44.1	25
<b>FS 25 MP 21.71</b>	Rockfall	450	28,000 sf	251	Fair	\$ 55,000	44.1	25
<b>FS 25 MP 24.63</b>	Rockfall	450	32,000 sf	465	Poor	\$ 318,125	44.1	25
<b>FS 25 MP 28.36</b>	Rockfall	450	9,000 sf	401	Poor	\$ 395,800	44.1	25
<b>FS 90 MP 13.26</b>	Rockfall	1500	34,000 sf	446	Poor	\$ 315,000	44.1	25
<b>FS 25 MP 25.11</b>	Rockfall	450	47,000 sf	354	Poor	\$ 162,600	44.1	25

\* The detour distance is calculated based on the assumed diversion to the assumed destination. In this example, it was assumed that Woodland, WA was the diversion point and the destination was Windy Ridge Lookout, which has a 44.1 mile longer route travelling through Randle, WA rather than through Cougar, WA. Due to the higher travel speeds on SR 12 and I-5 versus SR 503, the added 44 miles only takes an extra 25 minutes.

Although most data used in this cost-benefit work was taken directly from the 2014 data set, several assumptions were made to obtain Average Annual Daily Traffic (ADT) and detour information. ADT is required for all benefit/cost calculations, but it was not available for sites on FS 25. As a work-around, an ADT count was approximated based on the score selected for the “AADT / Usage / Economic or Recreational Importance Category.” All sites on FS 25 were given a score of 27 in this category, which is defined as “AADT 450 / Frequently used / Moderate Economic or recreational importance.” Based on this definition, an ADT of 450 was used for all sites on FS25. For detour length and time calculations, it was assumed that most of the travelers on FS 25 and the site on FS 90 were visitors heading to Windy Ridge on FS 99, and that most of these visitors started their trip somewhere before Woodland, Washington. In the event of a road closure, these visitors would detour and approach Windy Ridge from the north, passing through Randle, Washington. Detour lengths and times were calculated as the difference between the two routes. The detour/time assumptions may not be true for the FS 90 site, since that route has significantly higher ADT and provides access to the Mt. Adams area. No environmental benefit estimates were made during cost estimations; incorporation of these benefits could also change the calculated ratios in Alternatives 1 and 2.

Working with the site-specific data and with the cost estimates, the sample group was evaluated using the three cost/benefit evaluation alternatives. The cost/benefit ratio or priority index score for each site under the various approaches, along with the USMP site rank under each approach, is presented in Table 4. Note that under Alternatives 1 and 2, all asset types can be evaluated together, but under Alternative 3, separate priority lists must be developed for each asset type.

**Table 4. Calculating Benefit/Cost ratios or Priority Indexes for Gifford Pinchot National Forest sample sites. The USMP sites have also been ranked under each analysis alternative.**

Site Name	Hazard Type	Alternative 1		Alternative 2		Alternative 3	
		Benefit/Cost Ratio	Rank	Priority Index	Rank	USMP Score Priority Index	Rank*
FS 25 MP 28.33	Landslide	2.48	1	0.11	5	1313.53	1
FS 25 MP 24.45	Landslide	1.37	2	0.10	7	1114.96	3
FS 25 MP 24.7	Landslide	1.30	3	0.11	5	1029.46	4
FS 25 MP 25.11	Rockfall	0.61	4	0.14	4	3.41	5
FS 25 MP 29.44	Landslide	0.45	5	0.10	7	641.88	5
FS 25 MP 21.71	Rockfall	0.27	6	0.21	1	3.99	4
FS 25 MP 24.63	Rockfall	0.24	7	0.15	3	6.54	3
FS 25 MP 25.15	Landslide	0.22	8	0.10	7	1265.50	2
FS 25 MP 28.36	Rockfall	0.10	9	0.20	2	19.26	2
FS 90 MP 13.26	Rockfall	0.10	9	0.07	10	19.45	1

\* NOTE: Rockfall and landslide sites were ranked separately for Alternative 3.

In Alternative 1, the only option to incorporate specific risk reduction mitigation costs, the three sites with the highest benefit/cost ratios are landslides. The site with the highest benefit in this alternative is a landslide at Mile Post 28.33 on FS 25. The site on FS 90 has the lowest benefit/cost ratio, but this could change if the detour distance is updated to reflect more people using the road to travel to alternative locations.

In Alternative 2, the specific risk reduction mitigation cost estimates were replaced with an estimated unit cost based on asset type. As a group, rockfall sites moved up in the priority index relative to the benefit/cost calculation approach in Alternative 1. The landslide with the highest calculated benefit/cost ratio is now number five on the priority index. This may indicate something about the underlying geology of the rated corridor and an associated discrepancy from projected agency-wide unit costs.

Because of the difference in size calculations between landslides and rockfalls, Alternative 3 cannot be used to make a single priority list including all asset types. For improved clarity in discussion of this alternative, the assets are presented in separate groups in Table 5.

**Table 5. Priority index for Gifford-Pinchot sites calculated using Alternative 3, and organized from highest to lowest index score (note that rockfall and landslide hazards have been analyzed separately in the rankings).**

Site Name	Alternative 3		Site Name	Alternative 3	
	Priority Index - Rockfall			Priority Index - Landslide	
FS 90 MP 13.26	19.45		FS 25 MP 28.33	1313.53	
FS 25 MP 28.36	19.26		FS 25 MP 25.15	1265.50	
FS 25 MP 24.63	6.54		FS 25 MP 24.45	1114.96	
FS 25 MP 21.71	3.99		FS 25 MP 24.70	1029.46	
FS 25 MP 25.11	3.41		FS 25 MP 29.44	641.88	

Unlike Alternatives 1 and 2, the priority index does not directly incorporate any costs, not even typical unit costs. Instead, it links high-scoring sites, which are generally in worse condition, to ADT (a relative measure of route importance and safety risk) and site size (a relative measure of mitigation cost). On FS 25, where the same ADT has been assumed for all sites, this priority index becomes a comparison of the site total score/size ratio in the corridor. Speaking broadly, the largest sites in a corridor become the lowest priority to address because they impose the greatest risk reduction mitigation costs. This approach will lead to lower overall risk reduction in the corridor. Note that the rockfall site on FS 90, which was at the bottom of the indexes in Alternatives 1 and 2, is now the highest priority site in the rockfall index because the ADT for that site is more than three times higher than that estimated for the FS 25 sites.

Alternative 4 is designed to bridge the gap between Alternatives 1 and 2, making it possible for agencies to incorporate sites into their long-term planning goals, even if the data set is incomplete. However, the different equations used in these two alternatives generate numbers that are not comparable between the two approaches. In the Gifford Pinchot National Forest example USMP sites, benefit/cost ratios calculated in Alternative 1 were much higher than the ratios calculated using the Alternative 2 priority index. The most extreme example of this was the landslide on FS 25 MP 28.33, where the calculated benefit/cost ratio was 21 times higher in Alternative 1 than in Alternative 2. If an Agency is unaware that it is basing decisions on a mixed data set, where Alternative 2 is being applied to some sites, these sites will be passed over for funding due to the low benefit/cost ratios. To address this, **Alternative 4 should be used as part of a two-part system.** The Alternative 2 priority index is applied to all sites in the agency data set. The results of this analysis can then be used to help focus efforts on specific corridors or corridor segments for further study. The computed benefit/cost analysis of Alternative 1 would then be applied to this subset, helping to generate information that will be easily understood by high-level planners and applied when allocating budget resources.

## CHAPTER 7. HOW TO CONDUCT QUANTITATIVE RISK ASSESSMENT

Risk analysis for the USMP that considers natural hazards that affect transportation corridors (roads and trails), such as landslides or rockfall, should be transparent, reproducible and comparable with similar analysis about other hazards that pose a risk to facilities or people. The methods that constitute the current standard for risk analysis in NPS, for example, include probability-impact graphs or risk matrices. While these methods are simple and quick to apply, they use qualitative language that is prone to differing interpretations, and they are not inherently transparent in the factors used to assess risk. Furthermore, the current methods do not allow easy quantitative risk comparisons with other common hazards. To achieve a greater degree of transparency, reproducibility and comparability in risk assessment, the NPS Geologic Resources Division (GRD) has been using a quantitative risk analysis (QRA) method adopted from the Australian Geomechanics Society (Australian Geomechanics Society, 2007) and work following the 2010-2011 devastating earthquake that induced rockfall in Christchurch, New Zealand (Massey, et al., 2012; Massey, et al., 2014). The QRA relies on empirical, modeled, or estimated probabilities, but it is possible that with some simple guidance and a graphical user interface, as opposed to a spreadsheet, FLMA geotechnical specialists and managers outside of NPS-GRD could make expeditious use of the QRA.

The currently used QRA consists of a straightforward four factor probability equation and a list of annually, or biennially, updated societal risks for comparison. Since the QRA used by GRD has been developed for, and applied to, rockfall and landslide hazards, it makes sense that a USMP would incorporate the QRA as an additional decision support tool for individual slopes or as part of a prioritization process within similar prioritized transportation corridors. While risk is already estimated as part of the USMP slope rating, a QRA that can be directly related to other societal risks has utility for greater context and as a tool to use if decisions about risk reduction mitigating actions or corridor closures need to be made rapidly. For an example of how the QRA can help further prioritize rated unstable slopes see Capps et al., (2017). In this example from Denali National Park in Alaska, the top ten USMP rated slopes on a newly rated priority corridor of 141 unstable slopes were analyzed with the QRA to help refine priorities among the top 10 rated slopes and provide context to park managers about the risk associated with each unstable slope evaluated.

The QRA module or tool is a graphical user interface implementation of the four factor QRA equation used by GRD and accessed from the USMP website interface. Users can enter in probability factors and items affecting probability factors such as rock size and number of boulders for rockfalls, or speed limit in a hazard zone, to generate annual or daily individual risk of damage, death, or injury. This risk probability may then be compared with other societal risks in an output comparison graph. Risk of death or injury occurrence and societal costs may also be estimated through input of the number of people exposed to the risk using the USDOT's Value of Statistical Live (VSL) guidance. A step-by-step description is provided in Appendix G for using the USMP QRA form.

## QRA ANALYSIS FACTORS

At least four factors need to be estimated or determined to estimate annual risk to an individual using facilities exposed to an unstable slope hazard: 1) the annual probability of an unstable slope event; 2) the probability of a person being present in the path of a falling rock or a landslide; 3) the time a person spends in the hazard zone; and 4) the vulnerability or consequence of being caught in an unstable slope event. These four factors can be expressed within the general risk equation:

$$R_{(AIR)} = P_{(occ)} \times P_{(loc)} \times P_{(pres)} \times P_{(vul)}$$

where:

- $R_{(AIR)}$  is the annual individual fatality or injury risk or the risk of damage to facilities.
- $P_{(occ)}$  is the annual probability of an unstable slope event affecting the hazard zone, the probability of occurrence.
- $P_{(loc)}$  is the probability of a person, if present in the hazard zone, being in the path of an unstable soil slope event in the full length of the hazard zone, or in the case of rockfall, one or more rocks at a given location, where the entire hazard zone is not necessarily affected by every event.
- $P_{(pres)}$  is the occupancy rate or rate of presence, the amount of time spent by an individual in the affected area.
- $P_{(vul)}$  is the vulnerability, or probability of a person being killed or injured by the event.

The four probability factors used in the USMP QRA are similar to factors used in other quantitative risk assessments such as the Australian Geomechanics Society (Australian Geomechanics Society, 2007), and a rockfall QRA used to evaluate rockfall risk following the 2010 and 2011 Christchurch, New Zealand earthquakes (Massey, et al., 2012; Massey, et al., 2014).

### Probability of Occurrence, $P_{(occ)}$

The first factor to estimate risk requires data that indicate the occurrence probability or frequency of an unstable slope event. Tracking the occurrence of unstable slope events with the USMP through periodic ratings or through new slope event forms provides baseline data for occurrence probability. In addition, scientific methods for dating unstable slope events can yield data for occurrence probability. In the absence of some basic tracking of events at a slope or scientific data, the future probability of the unstable slope event would need to be estimated.

If small numbers of unstable slope events at a site have been tracked over many years or large numbers of events have been tracked over several years, the recurrence probability ( $P$ ) of event  $x$  can be estimated using a “simple” recurrence equation,  $x$  events in  $n$  observations:

$$P(x) = x/n$$



If an event occurs and there is no, or very little, record of unstable slope events at a site, it is reasonable to assume that some slope condition changed or reached a threshold to allow for slope instability, and that this slope condition is still in effect. In this “prior” case, the period of observation under the current slope event generating conditions is limited, but it is still conservative to assume that there is some real chance of slope events in the future. This is an assumption based on an uninformative, yet objective prior, infrequent events over a small observation period. Rather than assuming a single or small number of events in a single or small number of observation periods is informative, the prior condition mentioned above is not very informative and equal probability should not automatically be assumed for either an unstable slope event occurring or not occurring in a given observation period. So, in this “uninformative prior” case the recurrence probability (P) of event  $x$  can be estimated using a statistical formulation for events that have occurred without a strong historical record,  $x$  times in  $n$  observations:

$$P(x) = (x + 1)/(n + 2)$$

When using either the “simple” recurrence or the “uninformative prior” recurrence estimate, the estimates should be adjusted as further observations are recorded and the QRA refined.

In addition to environmental unstable slope event triggering factors, any risk assessment for a surface geologic process must incorporate the risk of earthquake. A close proximity magnitude 5.5 or greater earthquake would likely cause significant rockfall (Mackey & Quigley, 2014; Massey, et al., 2014). Earthquake ground motion can also trigger a significant number of landslides (e.g., Huang and Fan, 2013). Earthquake probabilities or peak ground acceleration probabilities are estimated by the USGS, and these values can be used when performing the QRA.

### **Probability of Location, $P_{(loc)}$**

For landslide unstable slope events, the QRA assumes that the most likely landslide affects the entire hazard zone, and the probability of a person in the hazard zone being affected by the unstable slope event is 100%. For rockfall scenarios the following equation is used to estimate the probability that a person, if present in the hazard zone, will be in the path of one rock at a given location:

$$P_{1(loc)} = (2D+d)/L$$

Where  $D$  is the estimated diameter of the rock,  $d$  is the diameter of the threatened object, such as a person, and  $L$  is the length of the hazard zone. Since people are the potential victim, the Americans with Disabilities Act minimum doorway width of 81.5 cm (32 inches) is used for the diameter ( $d$ ).

During a rockfall, the probability of hitting the same location multiple times increases with the number of rocks generated by the rockfall event, such that if  $N$  rocks are randomly distributed across the slope:

$$P_{(loc)} = 1 - (1 - P_{1(loc)})^N$$

Once probability of occurrence and probability of location are assessed or estimated, there are two remaining risk factors that need attention.

### **Probability of Occupancy, $P_{(pres)}$**

The occupancy rate is the amount of time (measured as percent of time per year) an individual spends in the hazard zone. For transportation corridors, this is dependent on the length of the hazard zone and the speed a person travels through the hazard zone. The exposure of maintenance personnel in this hazard zone should also be considered.

### **Probability of Vulnerability, $P_{(vul)}$**

Vulnerability is a consequence and must be estimated or based on previous unstable slope events. The estimated consequence could range in severity from damage to destruction of infrastructure, or injury to death for people impacted by unstable slope events. The two following empirical examples show how consequence may be estimated based on previous events:

- For landslides, the widely reported and researched landslide in Oso, Washington on March 22, 2014 killed about 74% of the people that were in its path.
- For rockfall, Grant et al. (2017) found a strong power-law correlation between modeled kinetic energy (KE), measured in kilojoules from impact on timber framed house walls, and runout distance (m) into and through the structure ( $0.064KE^{0.75}$ ), and area (m<sup>2</sup>) directly impacted within a structure ( $0.023KE^{0.97}$ ). This work also observed that a rockfall event energy threshold may exist at approximately 10 kJ (~3.7 ft-tons). Below about 10 kJ, very small portions of each structure within the study were affected, but above 10 kJ significant consequences are possible. Based on this work, it is likely that above approximately 10 kJ (~3.7 ft-tons), rockfall striking people would likely result in a fatality.

Even with some empirical examples, judgment is likely to be required to determine the probability of a fatality from rockfall or landslide because the specific components of each scenario may differ. Specific aspects could include the size of the probable rock striking the person and the likelihood of striking vital portions of the body. If the unstable slope event is a rockfall, and the energy of the rockfall is potentially higher during an earthquake triggered event, because of larger boulder sizes or some other factor, the probability vulnerability will be higher for an earthquake triggered event. Estimating the probability of injury or damage to a facility may involve less uncertainty as any unstable slope event that strikes a person or facility very likely causes injury or damage.

## **ESTIMATED CHANCE OF AN INCIDENT**

Once annual individual risk is estimated, it is possible to estimate the annual chance of an incident by multiplying the annual individual risk by the annual number of individuals exposed to the hazard.

## **RISK REDUCTION BENEFIT/COST ANALYSIS**

Once a life/safety risk has been estimated, the benefit of mitigating the risk can be assigned a monetary value using the concept of a Value of a Statistical Life (VSL) for people at risk and/or the value of infrastructure at risk. VSL is the estimated cost of mitigating the risk of a fatality. The US Department of Transportation Value of a Statistical Life is about \$9.6 million in 2017 dollars (US Department of Transportation, 2013). This figure, multiplied by the estimated risk and the number of people at risk, provides an estimate for the value of mitigating the risk. Since it is not always possible to completely mitigate risk, the QRA benefit/cost analysis assumes a target natural hazard annual individual fatality risk probability of one in a million ( $1 \times 10^{-6}$ ). This risk level would be the goal for full mitigation or significant risk reduction and would bring the unstable slope event risk down into the range of other natural hazard risks.

## REFERENCES

- AASHTO. (2010). *User and Non-User Benefit Analysis for Highways*. American Association of State Highway and Transportation Officials.
- Anderson, S., Schaefer, V., & Nichols, S. (2016). Taxonomy for Geotechnical Assets, Elements, and Features.
- Australian Geomechanics Society. (2007). Practice note guidelines for landslide risk management. *Journal and News of the Australian Geomechanics Society*, 42(1), 63-114.
- Beckstrand, D., Black, B., Mines, A., Stanley, D., Thompson, P., Jackson, J., Helm, S., Boundy, B. (2017a) *Montana's Rock Slope Asset Management Program (RAMP)*, 68th Highway Geology Symposium, Marietta, GA, May 2017.
- Beckstrand, D., Mines, A., Pierson, L., Thompson, P., Kimmerling, R., Benko, B., Stanley, D. (2017b) *Alaska's Geotechnical Asset Management Program*, Third North American Symposium on Landslides, Roanoke, VA, June 4 - 8 2017.
- Beckstrand, D., Mines, A., Thompson, P., & Benko, B. (2016). Development of Mitigation Cost Estimates for Unstable Soil and Rock Slopes Based on Slope Condition. *The 2016 Annual Meeting Compendium of Papers*. Transportation Research Board.
- Bureau of Land Management. (2009). *Asset Management Plan*. Retrieved from [http://www.blm.gov/style/medialib/blm/wo/Business\\_and\\_Fiscal\\_Resources/asset\\_management\\_plan.Par.66677.File.dat/2009AssetManagementPlan.pdf](http://www.blm.gov/style/medialib/blm/wo/Business_and_Fiscal_Resources/asset_management_plan.Par.66677.File.dat/2009AssetManagementPlan.pdf)
- Bureau of Land Management. (2011). *Roads National Inventory and Condition Assessment Guidance & Instructions Handbook*. Retrieved from [http://www.blm.gov/style/medialib/blm/wo/Information\\_Resources\\_Management/policy/blm\\_handbook.Par.85371.File.dat/H-9113-2.pdf](http://www.blm.gov/style/medialib/blm/wo/Information_Resources_Management/policy/blm_handbook.Par.85371.File.dat/H-9113-2.pdf)
- Cambridge Systematics. (2002). *Asset Management Guidance for Transportation Agencies*. FHWA, NCHRP Project 20-24(11), Washington, DC.
- Capps, D.M, Rosenberg, R., Collins, A., Hooper, S., Rogers, H., Anderson, D.A., and Bilderback, E. (2017) *Geohazards Risk Assessment of the Denali National Park Road*, In De Graff, J.V. and Shakoor, A. (eds.), *Landslides: Putting Experience, Knowledge and Emerging Technologies into Practice*, AEG Special Publication No. 27, p. 840-850.
- Federal Highway Administration. (2015, January 5). *NRPM: National Performance Management Measures; Assessing Pavement Condition for the National Highway Performance Program and Bridge Condition for the National Highway Performance Program*. Notice of Proposed Rulemaking, FHWA. Retrieved from <http://www.gpo.gov/fdsys/pkg/FR-2015-01-05/pdf/FR-2015-01-05.pdf>
- Gordon, M. G., Smith, G. J., Thompson, P. D., Park, H., Harrison, H., & Elston, B. (2011). *AASHTO Transportation Asset Management Guide Volume 2: A Focus On*

- Implementation*. Washington DC: American Association of State Highway and Transportation Officials.
- Grant, A., Wartman, J., Massey, C. I., Olsen, M. J., O'Banion, M., & Motley, M. (2017). *The impact of rockfalls on dwellings during the 2011 Christchurch, New Zealand earthquakes*. Landslides, <https://doi.org/10.1007/s10346-017-0855-2>.
- Guerre, J., Groeger, J., Van Hecke, S., Simpson, A., Gonzalo, R., & Visintine, B. (2012). *Improving FHWA's Ability to Assess Highway Infrastructure Health Pilot Study Report*. Washington DC: Federal Highway Administration. Retrieved from <http://www.fhwa.dot.gov/asset/pubs/hif12049/hif12049.pdf>
- Holmes, R.R., Jones, L.M., Eidenshink, J.C., Godt, J.W., Kirby, S.H., Love, J.J., Neal, C.A., Plant, N.G., Plunkett, M.L., Weaver, C.S., Wein, A. & Perry, S.C. (2012), *U.S. Geological Survey natural hazards science strategy - Promoting the safety, security, and economic well-being of the Nation*, Circular 1383-F, 1383-F, U.S. Geological Survey.
- Huang, R. & Fan, X. (2013) *The landslide story*. Nature Geoscience, 6(5), pp. 325-326.
- Landslide Technology. (2015). *Rockfall Hazard Process Assessment: Task 1 Report Literature Search and Information Technology Review*. Retrieved from <http://www.mdt.mt.gov/research/projects/geotech/rockfall.shtml>
- Mackey, B. H., & Quigley, M. C. (2014). *Strong proximal earthquakes revealed by cosmogenic <sup>3</sup>He dating of prehistoric rockfalls, Christchurch, New Zealand*. Geology, 42(11), 975-978.
- Massey, C. I., McSaveney, M. J., Heron, D., & Lukovic, B. (2012). *Canterbury Earthquakes 2010/11 Port Hills slope stability: Pilot study for assessing life-safety risk from rockfalls (boulder rolls)*. GNS Science Consultancy Report 2011/311.
- Massey, C.I., McSaveney, M.J., Taig, T., Richards, L., Litchfield, N.J., Rhoades, D.A., McVerry, G.H., Heron, D.W., Ries, W. & Van Dissen, R.J. 2014, Determining rockfall risk in Christchurch using rockfalls triggered by the 2010–2011 Canterbury earthquake sequence, New Zealand., *Earthquake Spectra*, 30, pp. 155-181
- NCHRP. (2006). *Performance Measures and Targets for Transportation Asset Management*. Washington DC: Transportation Research Board. Retrieved from [http://onlinepubs.trb.org/onlinepubs/nchrp/nchrp\\_rpt\\_551.pdf](http://onlinepubs.trb.org/onlinepubs/nchrp/nchrp_rpt_551.pdf)
- NCHRP. (2009). *Communication Matters - Communicating the Value of Transportation Research*. Washington DC: Transportation Research Board. Retrieved from [http://onlinepubs.trb.org/onlinepubs/nchrp/nchrp\\_rpt\\_610.pdf](http://onlinepubs.trb.org/onlinepubs/nchrp/nchrp_rpt_610.pdf)
- Pierson, L., & Van Vickle, R. (1993). *Rockfall Hazard Rating Program - Participants' Manual*. Washington DC: FHWA.
- Pierson, L., Beckstrand, D., Black, B. (2005). *Rockfall Hazard Classification and Mitigation System.*: Montana Department of Transportation. Report No. FHWA/MT-05-011/8174.

- Sanford Bernhardt, K., Loehr, J. E., & Huaco, D. (2003). Asset Management Framework for Geotechnical Infrastructure. *Journal of Infrastructure Systems*.
- Stanley, D. A., & Pierson, L. A. (2011). Geotechnical Asset Management Performance Measures for an Unstable Slope Management Program. *Proceedings 62nd Highway Geology Symposium*. Lexington, KY.
- Stanley, D. A., & Pierson, L. A. (2012). Performance Measures for Rock Slopes and Appurtenances. In E. F. Eberhardt (Ed.), *Landslides and Engineered Slopes: Protecting Society through Improved Understanding, Proceedings of the 11th International and 2nd North American Symposium on Landslides and Engineered Slopes, Vol. 2*, (pp. 1113-1118). Banff, Alberta, Canada.
- Thompson, P. D. (2016). Geotechnical Asset Management Plan - Technical Report, Report No. STP000S(802)(B).
- Thompson, P. D., Pierson, L. A., & Beckstrand, D. L. (2014, March/April). Condition Indices, Performance Measures, and Managing Performance Data for Geotechnical Asset Management – Don't Get Buried! *GEOSTRATA*. Retrieved from <http://geostrata.geoinstitute.org/article/2014-03-04p26-30/>
- US Department of Transportation. (2013). *Guidance on Treatment of the Economic Value of a Statistical Life in U.S. Department of Transportation Analyses*. US Department of Transportation. Retrieved from <https://www.transportation.gov/sites/dot.dev/files/docs/VSL%20Guidance%202013.pdf>
- US Forest Service. (2009). *Road System Operations and Maintenance Handbook: Chapter 60 - Road Maintenance*. Retrieved from Road System Operations and Maintenance Handbook: Chapter 60 - Road Maintenance
- Vessely, M. (2013). Geotechnical Asset Management, Implementation Concepts and Strategies. Central Federal Lands Highway Division.

**APPENDIX A. USMP RATING FORM DETAILED DESCRIPTIONS**

**UNSTABLE SLOPE MANAGEMENT  
PROGRAM FOR FEDERAL LAND  
MANAGEMENT AGENCIES –  
RATING CATEGORY  
DESCRIPTIONS**

Landslide Technology, WFLHD, NPS,  
USFS, BLM, and Bureau of Indian Affairs (BIA)

**TABLE OF CONTENTS**

**SITE INFORMATION .....59**

**PRELIMINARY RATINGS .....65**

**DETAILED HAZARD RATINGS .....76**

**DETAILED RISK RATINGS (ROCKFALL AND LANDSLIDES).....88**

**REFERENCES FOR APPENDIX A .....95**



## SITE INFORMATION

The top of the field data collection sheet contains fields for the collection of location and site information. These fields record location information and field measurements critical for later rating criteria. Many of the fields should be self-evident to the geological or engineering personnel who will be providing training, overseeing, and possibly performing the ratings, but some of the fields are explained in more detail below. Heading order follows the rating form (see sample slope rating form in Appendix B).

### Management Area

Federal Land Management Agency (FLMA) management area, specific for each FLMA. Examples include the region and four letter Park/Area code for the NPS, state and field office for the BLM, or region and forest for the US Forest Service. The “Other” category should be used when the transportation asset does not occur on land managed by NPS, BLM, or USFS. Select the State and County for the corresponding dropdowns in the “Other” category. These are standardized on the electronic forms.

### Hazard Type

The section is divided into two unstable slope hazard types, rockfall and landslides. Rockfall failure types include classic failure mechanisms (planar, wedge, and toppling), raveling rock slopes (such as talus slopes) (Hoek & Bray, 1981), rock avalanche, differential erosion (interlayered weak and stronger rock), and indeterminate rock failures. See Figure 1 for simplified schematic drawings of each rock failure type. Note that the ‘Indeterminate Rock Failure’ classification is primarily for sites where the rockfall mechanism is a complex interaction between multiple joints such that the straightforward planar, wedge, or toppling models are insufficient to describe the failure mechanism. This classification may be quite common in steep, hard, jointed rock cuts. Marking multiple selections is permissible.

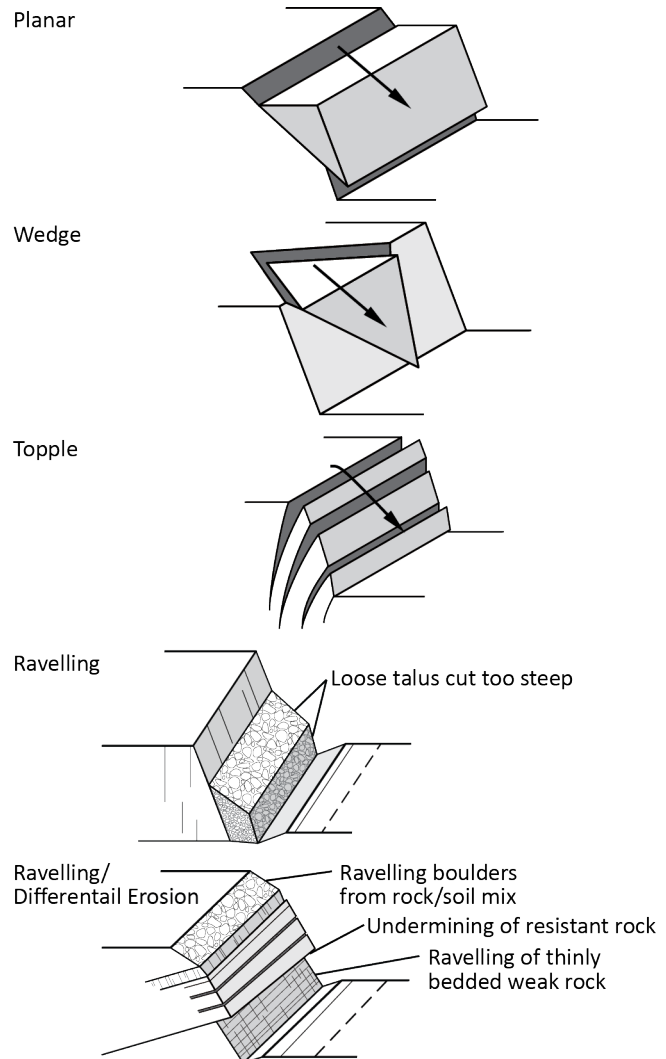

**Figure 1. Simplified rock slope failure types (planar, wedge, and toppling adapted from Hoek & Bray, 1981).**

Landslides can be generally classified by both their location relative to the route in question and by broad failure mode. Translational slides are typically composed of intact blocks that are moving on a flat or inclined discrete failure plane weaker than the surrounding geologic material. Rotational slides are typically formed by a circular failure surface, often on steep slopes. Debris flows are sudden, fast moving flows comprised of rock, soil, water and woody debris. Shallow slumps are common on transportation systems where the shoulder or outside lane are failing within the fill material or from debris above the road. Erosional failures are typical where the river system or culvert outfall is eroding the embankment or slope below the road which currently or may threaten the route in the future. See Figure 2 for simplified schematic drawings of each soil failure type, some modified from Cruden and Varnes, 1996 or Cornforth, 2005.

**Road/Trail No. and Classification**

Use the standard road numbering or naming approach for the FLMA’s road system. Note the road or trail’s classification (abbreviated as ‘class’ on the form) according to the Agency’s road maintenance or use level classification/designation schema.

**Length of Affected Road/Trail**

This is measured as the length of the road or trail adjacent to the hazard. For rockfall, it is measured from the start to the end of the cut slope or outcrop, not just where the highest level of rockfall activity is present. For landslides, it is measured from the beginning to the end of the slide where it is affecting the road or trail. For roadways, the affected length measurement includes both the paved road surface and the embankment on which the road is founded. For slides above the road, the affected length is measured as the distance over which the slide is

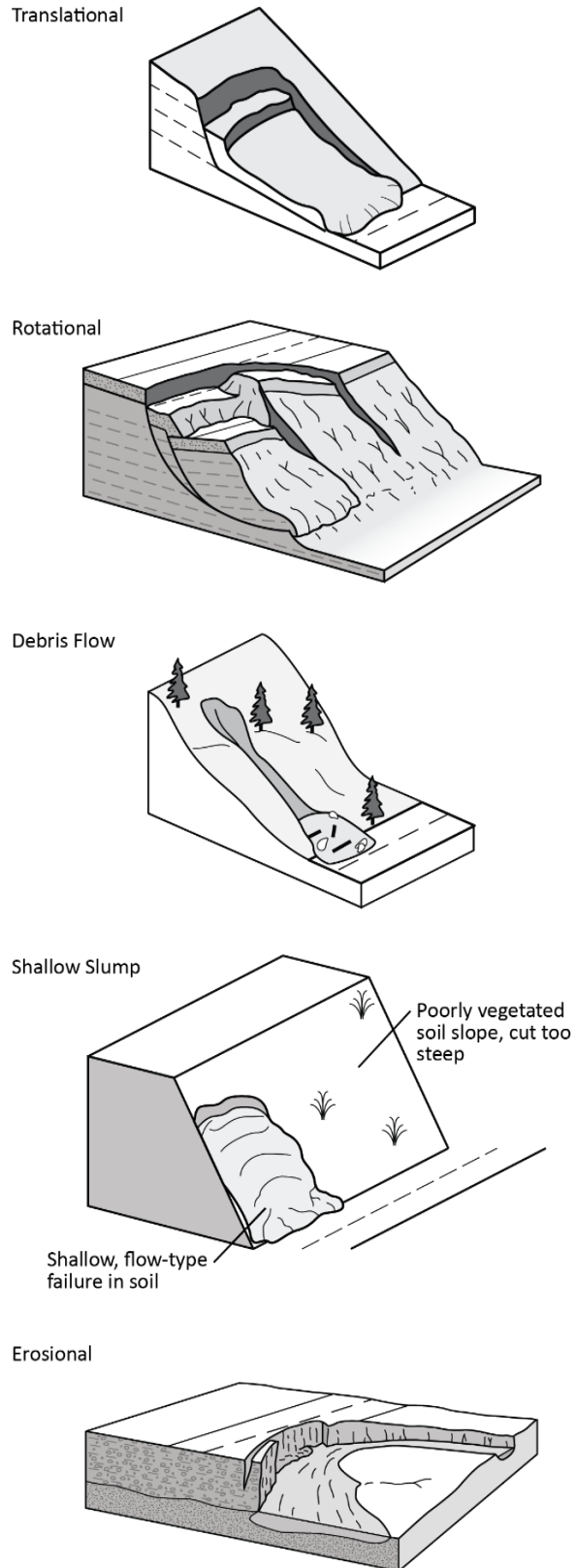

**Figure 2. Simplified landslide failure types (Cruden & Varnes, 1996; Cornforth, 2005).**

likely to impact the road or trail, from one end to the other. This measure is used in rating calculations.

### Beginning and Ending Mile Markers

Use the posted mile markers and an offset with two decimal places. Ancillary vehicle devices (such as distance measuring devices) are helpful, but not required. Third-party mobile device odometer applications may also provide sufficiently accurate offsets. When markers are not posted, or used, a distance with direction from a main intersection may be sufficient to note in the comments section on the form. However, based on USMP practitioner feedback, it is strongly suggested that latitude and longitude locations be used as the primary locator because mile markers (when present) can change over time with realignments and administrative changes to road mileage.

### Side of the Road

Side of the road or trail is either *left* or *right* while travelling up mile point. When an unstable slope impacts both sides of the route, like a deep-seated landslide, note the upslope direction for side of the road or trail. Use cardinal directions when the route does not have mile markers posted.

### Datum

Record the datum of the coordinate system. Note that WGS 84 is required for proper entry into the online mapping system so coordinates may need to be converted to WGS 84 if collected in another format.

### Slope Height/Axial Length

This is measured as the maximum vertical height of the rock slope or the maximum axial length (slope distance) of a landslide feature. On short embankments where it appears that a fill failure is at fault, this measure is typically the axial length from the top to the base of fill; in other cases, engineering judgment may be needed. For debris flows, the axial length measurement could be in the thousands of feet due to the channel length (or axial length) being quite long. For safety and expediency, often times the axial length of the track of the debris flow can be measured through recent orthophotography or widely available electronic imaging available on the internet (see note 1 in Category K below). This measure is used in

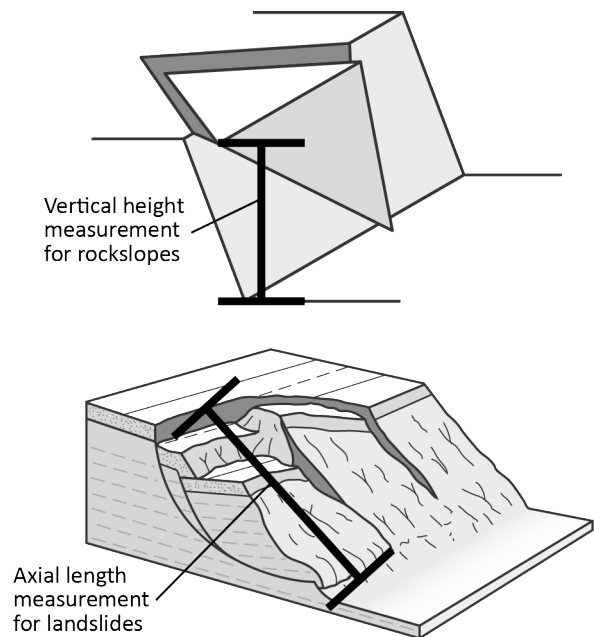

**Figure 3. Examples of measuring vertical slope height on a rock slope and axial length on a landslide.**

rating calculations. See Figure 3 for an example of evaluating slope height for rock slopes or landslides.

### **Slope angle**

This is the average or representative angle of the rock cut slope/outcrop or the angle of the failing embankment or soil slope. This measure is not used in rating calculations.

### **Sight Distance**

Sight distance is measured as the length of roadway from when a two-foot object is first seen from a driving position (3.5 feet from the road surface) until the object is reached. Sight distance is typically hindered by narrow shoulders, poor ditch vegetation control, and vertical and horizontal roadway curvature. The location's sight distance should be measured in the lane direction with the worst visibility. This measure is used in rating calculations.

### **Roadway/Trail Width**

This is measured as the available paved width of the roadway or trail, including paved shoulders as it exists at the time of rating. If the slope is rated while the road is partially closed due to debris or damage, repair of damage to the full width would require a new or updated rating to document the improvement to this unstable slope section. On unpaved routes, such as aggregate or native surface roads or trails, it would be measured as the drivable or navigable width. Where width changes within a section, it should be taken at the narrowest part of the section. This measure is used in rating calculations.

### **Speed Limit**

Record the speed limit in effect at the unstable slope. If lower advisory speeds are posted, those supersede the regular, posted speed limit. This measure is used in rating calculations.

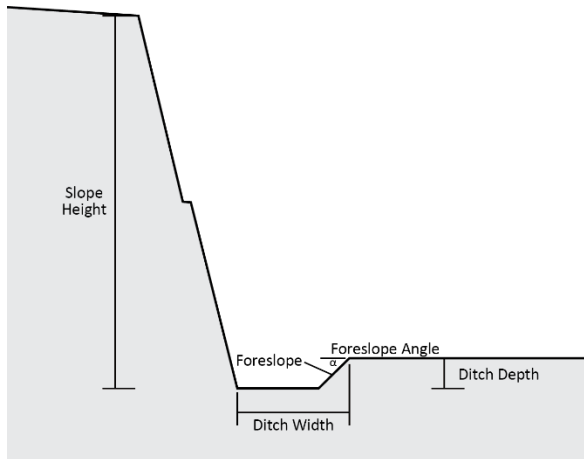

**Figure 4. Simple schematic of rock slope ditch.**

### **Ditch Width/Depth/Foreslope**

For rockfall areas, the roadside catchment ditch is an important rockfall risk reduction mitigation measure. A clean, wide ditch with a well-maintained foreslope is one of the most common risk reduction mitigation measures on transportation systems. Provide a measure of the range of ditch widths and depths and a representative foreslope angle. If needed, provide a note on the cleanliness of the ditch in the comments area of the form. This measure is not used in rating calculations.

### **Block Size/Volume**

**For rockfall only.** Enter a reasonable value for the largest rock size (in feet) that could enter the roadway. This can be estimated by observation of rocks in the ditch, rocks that appear loose on the slope, or interviews with maintenance personnel (preferred). If a volumetric event is the dominant failure mechanism, enter the number of cubic yards that have or reasonably could enter the roadway. Again, interviewing maintenance personnel is very important to collect this historical information. This measure is used in rating calculations.

### **Annual Rainfall**

Enter the average annual rainfall for the location. This measure is used in rating calculations. If a range is not available, then use the average rainfall for both ends of the minimum-maximum range. Precipitation maps are typically available on a statewide basis from Regional Climate Centers (such as the Western Regional Climate Center (<http://www.wrcc.dri.edu/>) or the state's weather service. This measure is used in rating calculations.

### **Sole Access Route**

If there are no alternative routes or detours in the event of a road closure, select "Yes", otherwise select "No". When seasonal closures create a sole access route condition, select "Yes". This measure is not used in rating calculations.

### **Mitigation (Fixes) Present**

If mitigation measures have been undertaken to halt or slow down a landslide, stabilize the rock slope, prevent rocks from reaching the roadway, etc., check the appropriate box. Typically, asphalt patches do not offer any appreciable stabilization effect on landslides and eventually can accelerate movement, so do not include patching or crack sealing as mitigation for landslides. On the paper field form, this field is listed as 'Fixes Present' due to space constraints. This

measure is not used in rating calculations but provides a searchable field for uploading past unstable slope work documents and photos.

### **Photo/Documents Upload**

Take (GPS-located) site photos and upload with your preferred hand-held device using the USMP Android or iOS application (recommended). Note that the size of photos and documents will be automatically reduced to 1600 by 1600 pixels to conserve space. Downloaded documents are limited to 10 Mb in size. For the paper forms, record the photo number range for the photos taken at the site, such as DSC005891.JPG to DSC005898.JPG, to help stay organized. These are often viewable on the digital camera's image review screen.

## **PRELIMINARY RATINGS**

The preliminary ratings are a select subset of the comprehensive rating categories. This subset is intended to provide guidance on whether to continue the rating assessment and can be used to include or exclude a candidate unstable slope location from the final database. If a site falls below the suggested score cutoffs, an agency may opt to completely exclude the site from the unstable slope database. If a site later becomes more of an issue, it should be assumed that the site has degraded from an acceptable to an unacceptable condition. If the site's Preliminary Rating is above the suggested cutoff score of 21 (all scores of '3,' with allowance of one '9'), the full field rating should be completed.

Note that all calculated category scores max out at 100 points.

When evaluating categories that are not calculated and have a max score of 81 points, it is not uncommon to determine that you are between two rating categories, for example, between 9 and 27. When in doubt, it is advisable to select the higher rating value, and be consistent in your usage of this rule-of-thumb. When programmatic decisions are made for scoring cutoffs, you will want to make sure a seasoned geotechnical specialist will have an opportunity to review these unstable slopes that may be on the cusp of the cutoff score. As part of the conceptual design work, the geotechnical specialist will review the USMP rating and adjust it as needed. In some cases, this will lower some of the total scores below the cut line and they will not be further considered for conceptual design at this stage of the process. Selecting lower scores in some situations could result in missing some unstable slopes that deserved to be in the cutoff for further evaluation. This discussion will become clearer as you use the USMP process more and more.

### **Landslide-Specific Preliminary Hazard Ratings**

Letters used in subsection headings correspond to specific fields in the slope rating forms (see Appendix B.)

#### ***A. Roadway Width Affected***

When a part of the roadway or trail is lost, or blocked the following can occur: collision with the debris, driving off a scarp, attempting an evasive maneuver where the driver goes off the road or into oncoming traffic, or a hiker is forced into a hazardous situation that can lead to an accident. The hazard is related to the percentage of the roadway or trail affected.

**Table 1. Preliminary Landslide Slope Rating – Roadway Impedance Category Narratives**

<b>3 points</b>	<u>0-5 percent</u> The travel lanes are generally not affected by the landslide feature, but the available paved surface is reduced. A detour or traffic control (flagging) is typically not required except during maintenance activities. Trails typically are only slightly affected.
<b>9 points</b>	<u>6-25 percent</u> Events affect up to 25% of the travel lanes. Adequate paved surface is available to maneuver around the event. A detour is typically not required but traffic control may need to be utilized until the roadway is reestablished. A visual cue for tripping hazards may be needed on trails.
<b>27 points</b>	<u>26-50 percent</u> Events affect up to half of the surface dedicated to travel lanes. Maneuvering actions may still be possible by using paved or unpaved shoulders, if available. A detour or complete vehicle stoppage may be required. A visual cue for tripping hazards may be needed on trails and maintenance may be considered.
<b>81 points</b>	<u>51-100 percent</u> Events affect more than half of the road with limited paved surface available to maneuver around the event. A detour or stopping traffic flow is required. Trails may be closed and maintenance may be required to keep the trail open.

Example of roadways affected by landslide or settlement-related displacement are presented in Figures 5 and 6 below. As shown in Figure 5, the affected roadway width can vary throughout the site extents. The score should be based on the largest percentage observed at the site or reasonably predicted to occur in the event of landslide movement.



**Figure 5. Embankment failure affecting up to 25 percent of the roadway. Forest Service Road 25, Milepost 30.**





**Figure 6. Embankment failure affecting entire roadway. Forest Service Road 25, Milepost 25.**

***B. Slide/Erosion Effects***

Unanticipated condition changes in a travel lane, such as those shown in Figure 7 at right, can result in unsafe maneuvers or loss of vehicle control. Larger obstructions increase the likelihood of an accident and require more maintenance effort and cost to repair. The category is scored by following the rating category narratives in the table below. Offsets indicated in the table below can be either horizontal or vertical.

*Note: For trails, the slower driving speed indicated in the table below may be reflected in increased tripping hazards rather than lower speed limits.*



**Figure 7: Roadway deformation caused by embankment failure. Forest Service Road 90, Milepost 11.5.**

**Table 2. Preliminary Landslide Slope Rating – Slide/Erosion Effects Category Narratives**

<b>3 points</b>	<p><u>Visible crack or slight deposit of material on road/minor erosion.</u> For <i>paved</i> routes, slight pavement cracking or heaving, or a thin deposit of slide debris has occurred but they are small enough not to disturb traffic flow or require evasive maneuvers. Scheduled roadway maintenance is required.</p> <p>For <i>thaw unstable slopes</i> and/or <i>unpaved</i> routes, normal roadway speeds and driving behavior is maintained throughout the affected section.</p> <p>For <i>trails</i>, public activity is not affected.</p>
<b>9 points</b>	<p><u>1-inch offset, or 6-inch deposit of material on road/major erosion will affect travel in &lt;5 years.</u> For <i>paved</i> routes, a noticeable drop or heave in the pavement or a deposit of slide debris has occurred that requires lower speeds to traverse. Maintenance attention is required.</p> <p>For <i>thaw unstable slopes</i> and/or <i>unpaved</i> routes, a notable vertical movement is felt when traversing the affected roadway section at the speed limit.</p> <p>For <i>trails</i>, public activity is not affected, but movement is noticeable.</p>
<b>27 points</b>	<p><u>2-inch offset or 12-inch deposit of material on road/moderate erosion impacting travel annually.</u> For <i>paved</i> routes, a large drop or heave in the pavement or a deposit of slide debris has occurred that requires significantly lower speeds to traverse and may elicit unsafe driver reactions. Immediate maintenance attention is required.</p> <p>For <i>thaw unstable slopes</i> and/or <i>unpaved</i> routes, breaking or evasive maneuvering is required when travelling the speed limit.</p> <p>For <i>trails</i>, public activity is affected, prompting some to avoid the trail or turn back.</p>
<b>81 points</b>	<p><u>4-inch offset or 24-inch deposit of material on road/severe erosion impacting traffic consistently.</u> A major drop or heave in the pavement or deposit of slide debris has occurred that cannot be traversed. Unsafe driver reactions are likely and immediate maintenance attention is required to reestablish safe traffic flow.</p> <p>For <i>thaw unstable slopes</i> and/or <i>unpaved</i> routes, these sections have been marked by maintenance crews with warning signs, cones, or a temporary reduction of the speed limit.</p> <p>For <i>trails</i>, the trail is periodically closed due to slide activity or the public needs to carefully traverse a severe offset.</p>

**C. Roadway Length Affected**

The length of the roadway (or trail) affected by a landslide poses a hazard to the travelling public by increasing the likelihood of encountering the hazard, diverting into an adjacent lane, or increasing the distance or length of time the hazard will need to be avoided. To the agency, the length is proportional to the maintenance required and the costs associated with treatment. Longer slides will also require longer (both time duration and spatial length) lane closures during maintenance or repair activities.

The length of roadway affected by landslide deformation is measured in the field, and the score is directly calculated from these field measurements, using the equation below. A graph of this equation is also provided for reference in Figure 8, as well as a table showing sample category scores, Table 3.

$$Score = 3^x (\text{max } 100); x = \sqrt{\frac{\text{length of roadway affected}}{25 \text{ (feet)}}}$$

**Equation 1. Length of Roadway Affected Score**

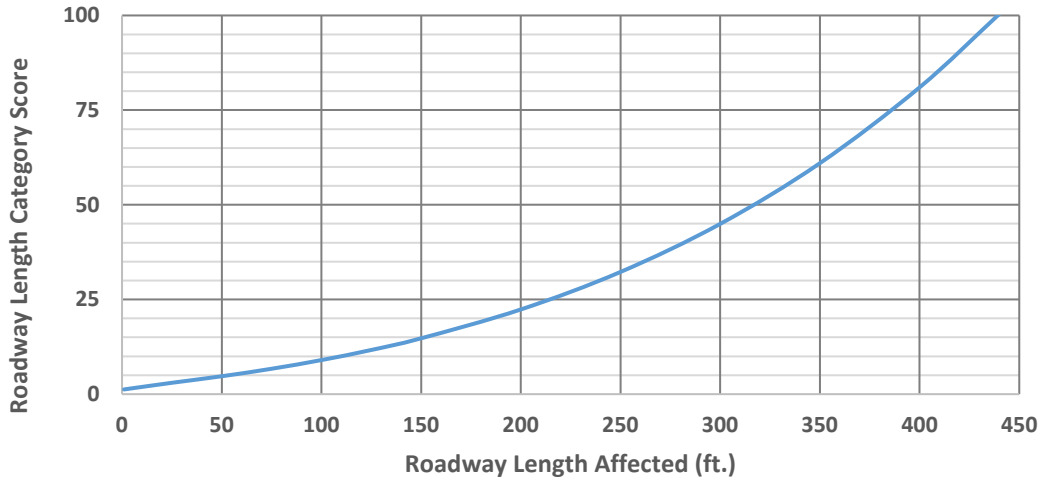

**Figure 8. Chart illustrating the relationship between the length of roadway affected and the category score. The category score maxes out at an affected roadway length of about 440 feet.**

**Table 3. Preliminary Landslide Slope Rating – Roadway Length Affected Sample Calculated Scores**

<b>3 points</b>	25 feet
<b>9 points</b>	100 feet
<b>27 points</b>	225 feet
<b>81 points</b>	400 feet

### Rockfall-Specific Preliminary Hazard Ratings

#### *D. Ditch Effectiveness*

The effectiveness of a ditch or catchment is measured by its ability to restrict falling rock from reaching the paved roadway, including any paved shoulder. The risk associated with a particular rock slope section is dependent on how well the ditch is performing in capturing rockfall. When little rock reaches the roadway, no matter how much rockfall is released from the slope, the danger to the public is low and the category score assessed is low. Conversely, if rockfall events are rare occurrences but the ditch is nonexistent, the resulting hazard is greater and a higher score is assigned to this category. Many factors must be considered in evaluating this category. The reliability of the result depends heavily on the rater's experience. Ditch Effectiveness is a subjective category. Figure 9 presents a graphic diagram of ditch effectiveness for guidance.

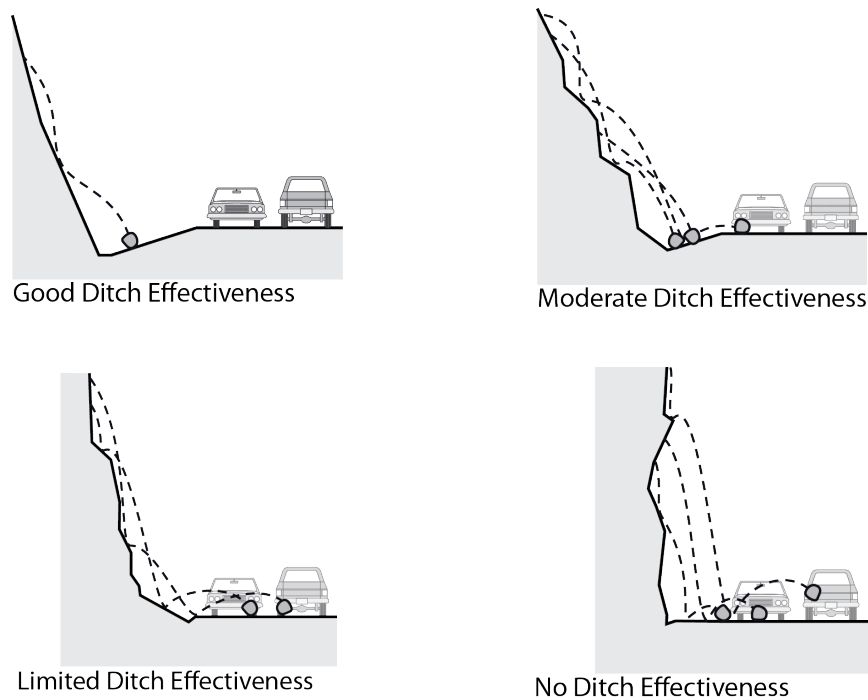

**Figure 9. Ditch effectiveness explanatory diagram.**

A wide fallout area does not necessarily guarantee that rockfall will be restricted from the highway. In estimating the ditch effectiveness, the rater should consider several factors, such as: 1) slope height and angle; 2) ditch width, depth and shape; 3) anticipated rockfall event volume or rock size; and 4) impact of slope irregularities (launch features) on falling rocks. Evaluating the effect of slope irregularities is especially important because they can completely negate the benefits expected from a fallout area. Valuable information on past ditch performance can be obtained from maintenance personnel.

**Table 4. Preliminary Rock Slope Rating – Ditch Effectiveness Category Narratives**

<b>3 points</b>	<u>Good Catchment.</u> All or nearly all falling rocks are retained in the catch ditch.
<b>9 points</b>	<u>Moderate Catchment.</u> Falling rocks occasionally reach the roadway.
<b>27 points</b>	<u>Limited Catchment.</u> Falling rocks frequently reach the roadway.
<b>81 points</b>	<u>No Catchment.</u> No ditch, or ditch is totally ineffective. All or nearly all falling rocks reach the road.

### ***E. Rockfall History***

The rockfall history directly represents the known rockfall activity at the site. This information is an important check on the potential for future rockfalls. This information is best obtained from the maintenance personnel responsible for the slope. There may be no history available at newly constructed sites or where documentation practices are poor. The maintenance costs associated with a site may be the only information that reflects the rockfall activity.

If the score a rater assigns to a section is determined not to correspond well with the rockfall history, a review of the rating is advisable.

**Table 5. Preliminary Rock Slope Rating – Rockfall History Category Narratives**

<b>3 points</b>	<u>Few Falls.</u> Rockfalls occur only a few times a year (or less), or only during severe storms. This category is also used if no rockfall history data is available and evidence of rockfall is absent.
<b>9 points</b>	<u>Occasional Falls.</u> Rockfall occurs regularly. Rockfall can be expected several times per year and during most storms.
<b>27 points</b>	<u>Many Falls.</u> Typically, rockfall occurs frequently during a certain season, such as the winter or spring wet period, or the winter freeze/thaw, etc. This category is for sites where frequent rockfalls occur during a certain season but are not a significant problem during the rest of the year. This category may also be used where severe rockfall events have occurred.
<b>81 points</b>	<u>Constant Falls.</u> Rockfalls occur frequently throughout the year. This category is also for sites where severe rockfall events are common.

***F. Block Size or Volume per Event***

Larger blocks or volumes of falling rock produce more total kinetic energy and greater impact force than smaller events. In addition, the larger events obstruct more of the roadway, reducing the possibility of safely avoiding the rock(s), and result in higher cleanup costs for the managing agency. In essence, the larger the blocks or event volume; the greater the hazard created; thus the higher the assigned score in this category.

This measurement should be representative of the type of rockfall event most likely to occur. As shown in Figure 10, debris currently contained in the roadside ditch can help generate a reasonable estimate. If individual blocks are typical of the rockfall at a site, as at the site in Figure 10, then block size should be used for scoring. If a mass of blocks tends to be the dominant type of rockfall, volume per event should be used. A decision on which to use can be determined from the maintenance history, or estimated from observed conditions when no history is available. This measurement will also be beneficial in determining remedial measures.



**Figure 10. Rockfall debris in the roadside ditch can be used to help assess both block size/event volume and failure type. Forest Service Rd 25, Milepost 25.**

The category score is calculated according to the following equations. If the rater is uncertain, or both block size and volumetric events are present/feasible, rate the site using both equations and record the higher of the two scores. If values for block size and volume are both present/feasible and entered into the USMP electronic form under the block size/volume in Site Information, the larger of the two calculations will be recorded in this category. A pair of charts showing the exponential relationship between block size/event volume and category score is also presented in Figure 11 for reference, as are sample calculated category scores in Table 6.

$$\text{Block Size Score} = 3^x \text{ (max 100)}; x = \text{block size (ft)}$$

$$\text{Volume Size Score} = 3^x \text{ (max 100)}; x = \left( \frac{\text{yds}^3}{3} \right)$$

**Equation 2. Block Size and Volume Size Score**

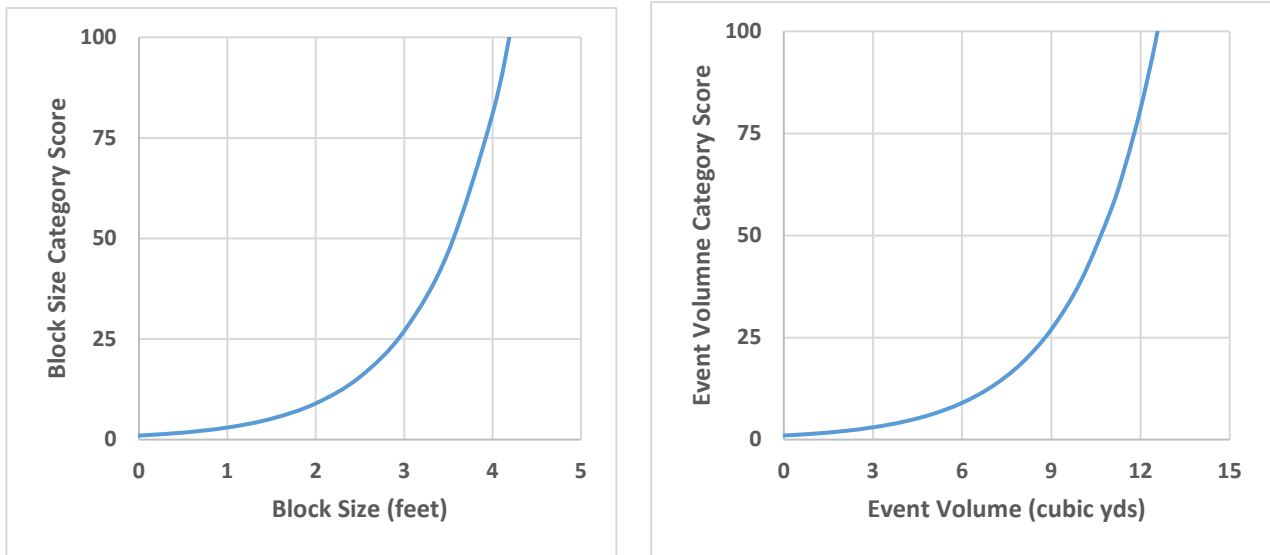

**Figure 11. Chart pair illustrating the relationship between the block size and the category score and between the event volume and the category score. Note that the category score for block size maxes out for block sizes greater than 4 feet, while the category score for event volume maxes out for events over 12 cubic yards.**

**Table 6. Preliminary Rock Slope Rating – Block Size or Volume Size Sample Calculated Scores**

	Block Size	Volume Size
<b>3 points</b>	1 foot	3 cubic yards
<b>9 points</b>	2 feet	6 cubic yards
<b>27 points</b>	3 feet	9 cubic yards
<b>81 points</b>	4 feet	12 cubic yards

**Common Preliminary Slope Risk Ratings (Rockfall and Landslides)**

**G. Impact on Use**

Impacts on the transportation system due to a failure can be minimized if the expected impacts would be minimal, or if a detour around the site is available. The scoring should take into account a *probable* worst-case scenario, rockfall history, and geologic conditions when judging the impacts on traffic.

**Table 7. Common Preliminary Rating – Traffic Impacts Category Narratives**

<b>3 points</b>	<u>Full use continues with minor delay.</u> A wide shoulder is available for traffic diversion for large slide events; small rockfall events contained in the ditch; nearby detours are available.
<b>9 points</b>	<u>Partial use remains. Use modification required, short (&lt;3mile/30min.) detour available.</u> Traffic control for a lane closure or detour is required for maintenance or clean-up. Detours are less than 3 miles or under 30 minutes in length for up to 1 day.
<b>27 points</b>	<u>Use is blocked – long (&gt;30 min) detour available or less than 1 day closure for up to 1 week.</u>
<b>81 points</b>	<u>Use is blocked – no detour available or closure longer than 1 week.</u> Major reconstruction efforts with weeks or months closure with no detour.

**H. Annual Average Daily Traffic (AADT) or Usage/Economic/Recreational Importance**

This category is designed to capture route or trail importance and can be assessed using either quantitative or qualitative data. The AADT of a roadway provides a rough quantitative indicator of its impact on the regional economy and mobility of people, goods, and services. High traffic corridors will receive a higher risk score. The AADT score is based on the following equation:

$$Score = 3^x \text{ (max 100)}; x = \frac{\sqrt{AADT}}{50}$$

**Equation 3. Annual Average Daily Traffic Score**

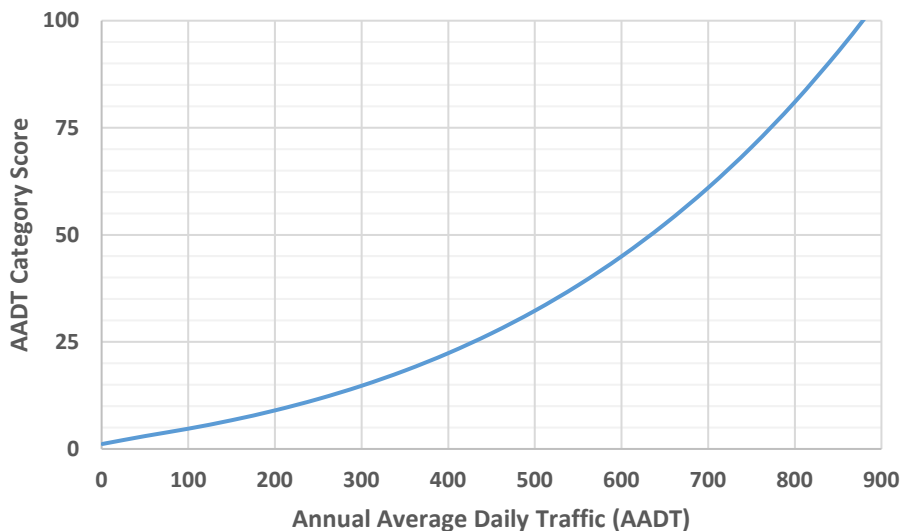

**Figure 12. Chart illustrating the relationship between AADT and the category score. The category score maxes out at an AADT of approximately 880 vehicles.**



For those roads or trails where AADT information is not available (uncheck the “Use AADT in Calculation” box on the electronic form), a qualitative score relating to usage and relative economic/recreational importance is applied, as shown in Table 8.

**Table 8. Common Preliminary Rating – AADT Sample Calculated Scores**

	AADT Score*	Qualitative Usage/Economic/Recreational Importance Score*
<b>3 points</b>	50	Rarely used. Insignificant economic and/or recreational importance
<b>9 points</b>	200	Occasionally used. Minor economic and/or recreational importance
<b>27 points</b>	450	Frequently used. Moderate economic and/or recreational importance
<b>81 points</b>	800	Constantly used. Significant economic and/or recreational importance

\*The highest rating of the two category narratives is applied

For a site where both quantitative (AADT) and qualitative (i.e., relative importance) data is available, both categories should be evaluated, and the highest resulting score given to the site. For example, a roadway that is the only route to a popular trail may be of moderate recreational importance (27 pts), but the AADT is only 200 (9 pts). For this site, the higher score of 27 would be used.

### **Preliminary Rating Score**

Following the completion of the Preliminary Ratings, the slopes can be categorized into one of three categories of ‘Good’, ‘Fair’, or ‘Poor.’ This language is consistent with Federal legislation for bridge and pavement asset management regulations. Depending on your agency’s approach to conducting ratings, ‘Good’ slopes may not require further assessment. If a slope is categorized as ‘Fair’ or ‘Poor,’ this may trigger further evaluation and completion of the Hazard and Risk Categories. At a minimum, Fair and Poor sites should have the full detailed ratings performed.

**Table 9. Good, Fair, and Poor Score Ranges.**

Descriptor	Preliminary Score Range
Good	15-21
Fair	22-161
Poor	>161

## DETAILED HAZARD RATINGS

The Detailed Ratings complete the suite of possible rating categories. Depending on an agency's rating approach, these categories will be evaluated if the Preliminary Rating is above a cutoff score, proposed as 21 in this manual, but official policy or documented decisions regarding the rationale for adjusting these cutoff scores between good, fair, and poor slopes are left to the discretion of each participating agency or department.

### Common Hazard Ratings (Rockfall and Landslides)

#### *I. Slope Drainage*

In conjunction with rainfall quantity, the ability of the slope materials to be free draining and the presence of seeps and/or springs (indicating a relatively constant water source) provides information on the ability of the slope to cope with rainfall and freeze-thaw events. This subcategory is based on subjective evaluations. Note that rating this category at different times of the year may produce different results as creeks and springs may dry up during late summer months. For guidance in field evaluations, Figure 13 is provided below, and rating category narratives are provided in Table 10.

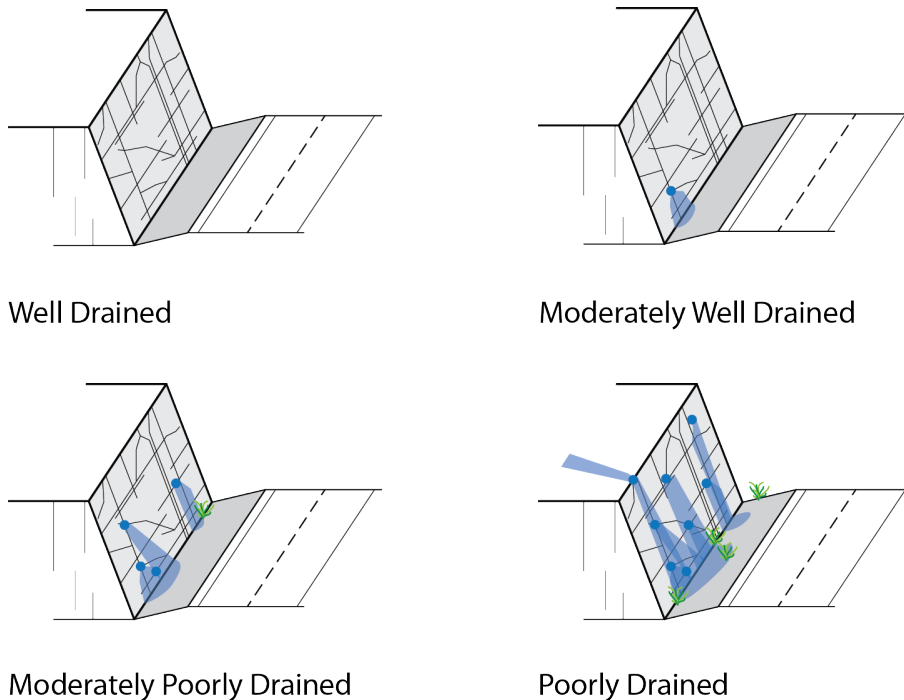

**Figure 13. Guidance figure for evaluating slope drainage.**

**Table 10. Common Hazard Rating - Slope Drainage Category Narratives**

<b>3 points</b>	<u>Well Drained.</u> Slope appears dry or well drained; surface runoff well controlled; slope is dry hours after rain events; or a functioning drainage system is installed.
<b>9 points</b>	<u>Moderately Well Drained.</u> Water is intermittently on slope; moderately well drained; surface runoff moderately controlled; slope is dry days after rain events.
<b>27 points</b>	<u>Moderately Poorly Drained.</u> Water usually on slope; poorly drained; surface runoff poorly controlled; slope is still wet a week or two following rain events, but may dry during prolonged dry spells.
<b>81 points</b>	<u>Poorly Drained.</u> Water always on slope; very poorly drained; or surface water runoff control not present.

**J. Annual Rainfall**

In conjunction with slope drainage, the amount of annual rainfall at a site is a rough indicator of the frequency and potential for high pore-water pressures to accumulate. Areas with frequent, intense storms typically have more unstable rock and soil slopes.

This subcategory is rated based on rainfall ranges. A rock slope in an area with 12 inches of average annual rainfall and a rock slope in an area with 29 inches of average annual rainfall should both receive a score of 9 points in this category. Because annual rainfall cannot be estimated during a site visit, annual rainfall data must be obtained from an appropriate regional or local source before starting field work.

**Table 11. Common Hazard Rating – Annual Rainfall**

<b>3 points</b>	0-10 inches of rain annually
<b>9 points</b>	10-30 inches of rain annually
<b>27 points</b>	30-60 inches of rain annually
<b>81 points</b>	60+ inches of rain annually

### K. *Slope Height or Axial Length of Slide*

This category evaluates the risk associated with the height of a rock slope or axial length of a landslide or debris flow. The slope height measurement is to the highest point from which rockfall is expected or the axial length (slope distance) of a landslide, as shown in the adjacent figure. The Site Information portion of the form should already contain these measurements.

If rockfall is generated from the natural slope above the cut slope, the slope height measurement should include both the cut height and the additional vertical height on the natural slope to the rockfall source. On a landslide, the distance from scarp to toe should be measured. For debris flows the approximate axial or channel distance from the roadway to the source area should be entered.<sup>1</sup>

In cold climates, thaw instability can affect roadway embankments that run over relatively flat ground. In those cases, the axial length of the slide is assumed to be equal to the axial length of the embankment fill prism. Although thaw instability can affect an embankment over many hundreds of feet, which is captured in the Roadway Length Affected in Category C, the maximum slump or settlement caused by thawing soils cannot exceed the height of the roadway embankment.

This category is directly measured and scored using the equation presented below. A chart relating slope height/axial length and category score is presented for reference, as is a table containing sample calculated category scores.

$$\text{Score} = 3^x \text{ (max 100)}; x = \frac{\text{slope height or axial length}}{25}$$

**Equation 4: Slope Height or Axial Length Score**

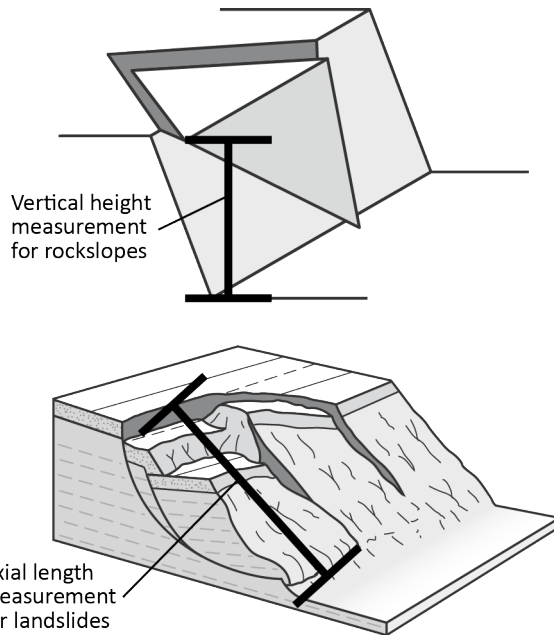

**Figure 14. Examples of measuring vertical slope height on a rock slope and axial length on a landslide.**

---

<sup>1</sup> Note: Channel length measurements for debris flows do not need to be precise, as the rating category score maxes out at a slope height/axial length of approximately 105 ft. An estimated channel length of 1,000 feet or of one mile has the same net effect: maxing out the rating score for this category.

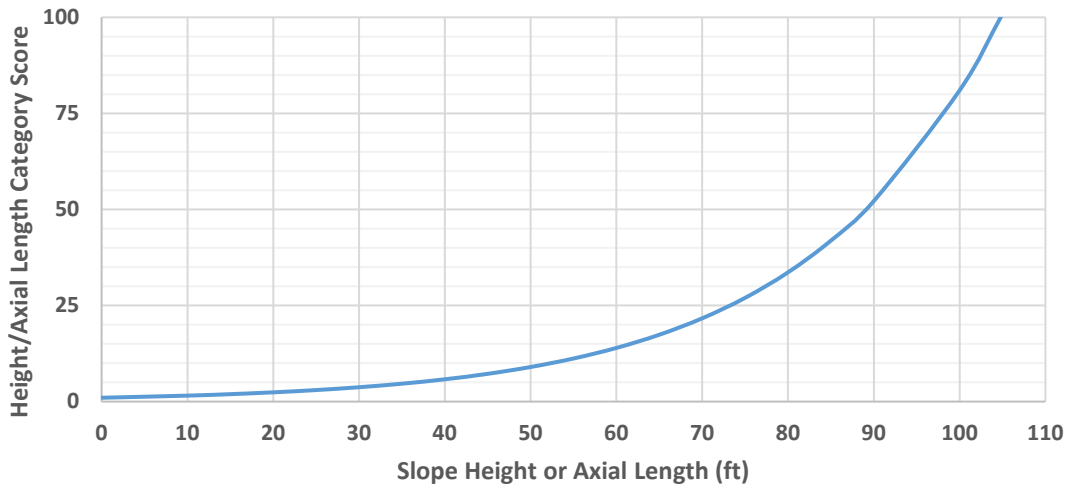

**Figure 15. Chart illustrating the relationship between the slope height or axial length and the category score. The category score maxes out at height/axial length of approximately 105 feet**

**Table 12. Common Hazard Rating - Slope Height or Axial Length of Slide Sample Calculated Scores**

<b>3 points</b>	25 feet
<b>9 points</b>	50 feet
<b>27 points</b>	75 feet
<b>81 points</b>	100 feet

## Landslide-Specific Hazards

### *L. Thaw Stability (Cold Climates)*

Roads and embankments founded on melting permafrost become unstable, creating a rough and wavy driving surface along with other roadway hazards. Melting slopes above the road become unstable and have the potential to impact the roadway. Depending on the gradation, soils containing frozen water pose maintenance problems if the ice thaws. The magnitude and likelihood of related problems are higher for finer-grained soils that contain large amounts of ice or ice layers. Where the ice-bearing layers are not visible, base the thaw stability on the relative performance of the roadway.

While performing field ratings, the subsurface condition described below can be estimated by the surficial expressions of thaw instability. For instance, thaw instability is often expressed by wavy pavements. Low amplitude ‘waves’ that developed over a long period of time represent greater thaw stability than higher amplitudes that develop quickly or need frequent repair.

Examination of nearby outcrops or cuts may expose ice conditions. A review of local geology and geomorphic features indicating ice (patterned ground, palsas, pingos, etc.) assists with interpreting subsurface ice conditions.

**Table 13. Detailed Landslide Slope Rating – Thaw Stability Category Narratives**

<b>3 points</b>	<u>Unfrozen / Thaw Stable.</u> Soil may be coarse- or fine-grained. No ice is visible with the naked eye, but if present, it does not occupy space in excess of the original voids. These soils are usually thaw-stable. No thaw unstable slopes should be rated in this category
<b>9 points</b>	<u>Slightly Thaw Unstable.</u> Soil is coarse-grained. Ice occupies space equal to, or in excess of, the original voids. It is present as crystals or lenses visible with the naked eye. These soils may be thaw-unstable depending on soil density. Few thaw unstable slopes should be rated in this subcategory.
<b>27 points</b>	<u>Moderately Thaw Unstable.</u> Soil is fine-grained. Ice occupies space equal to, or in excess of the original voids and is present as crystals or lenses visible with the naked eye. These soils are typically thaw-unstable. Most thaw unstable slopes are rated in this category based on relative performance of the roadway.
<b>81 points</b>	<u>Highly Thaw Unstable.</u> Soil layers contain significant quantities of ice well in excess of the original void space. The ice is readily visible with the naked eye and is present as large lenses or as separate ice layers. These materials are highly thaw-unstable. Any embankment sections with characteristics indicating a likelihood or history of rapid failure or severe displacement due to the presence of thaw unstable materials should be rated in this subcategory.

**M. Instability-Related Maintenance Frequency**

As instability-related movement progresses, trail or roadway deformation begins to hamper performance, and maintenance attention is required to ensure that the site remains passable. Slide maintenance puts staff and equipment in, or near the road, which may impede traffic and exposes both maintenance personnel and the general public to potential hazards. The more often maintenance activity is required, the greater the hazards posed to the public and maintenance staff, and the greater the maintenance cost.



**Figure 16. Instability requiring repeated maintenance attention. Forest Service Road 25, Milepost 25.**

Maintenance frequency should be determined through an interview with maintenance personnel, but it can be initially estimated by the rater based on field observation, and refined in interviews with maintenance personnel following field work. This category is rated subjectively based on the rating category narratives in Table 14 below.

**Table 14. Detailed Landslide Slope Rating – Maintenance Frequency Category Narratives**

<b>3 points</b>	<u>Every 10 years.</u> Events requiring maintenance intervention are relatively rare or nonrecurring and/or the repair activities can typically be completed using standard equipment with minimal impacts to traffic flow.
<b>9 points</b>	<u>Every 5 years.</u> Maintenance intervention is required occasionally and/or the repair activities can usually be completed in less than a day using standard equipment, but traffic flow is reduced and flagging is required.
<b>27 points</b>	<u>Every 2 years.</u> Maintenance action is routinely required and/or the repair activities require non-standard equipment or more than one day to complete; or the traffic flow is significantly impeded for more than a day and flagging is required.
<b>81 points</b>	<u>Every year.</u> Maintenance is required one or more times per year or wherever major events have occurred requiring several days to restore traffic. This category also applies if an outside contractor is required.

**N. Movement History**

The rate of slide movement per event and the frequency of events relate to public hazard and maintenance requirements. Higher rates of movement are more likely to create unanticipated roadway conditions that require immediate, unscheduled maintenance. This category should be rated based on input from maintenance personnel, since it is difficult to accurately assess an annual rate of movement from a single site visit. Movement magnitudes focus on paved roadways. For trails and unpaved roads, evaluate the impacts of movement according to the descriptions in Table 15.

**Table 15. Detailed Landslide Slope Rating – Movement History Category Narratives**

<b>3 points</b>	<u>Minor movement or sporadic creep.</u> The rate of movement is low and non-continuous. Pavement disturbance is minor on an annual basis and maintenance requirements are minimal and carried out as a scheduled activity.
<b>9 points</b>	<u>Up to 1 inch annually or steady annual creep.</u> The rate of movement is low but continuous. Corridor maintenance is routinely required to avoid closures but maintenance action can generally be conducted on a scheduled basis.
<b>27 points</b>	<u>Up to 3 inches per event, one event per year.</u> The rate of movement is moderately high. Events occurring more than twice a year that require immediate and unscheduled maintenance are a persistent maintenance problem.
<b>81 points</b>	<u>&gt;3 inches per event, &gt;6 inches annually, or more than 1 event per year (includes all debris flows).</u> The rate of movement is high with significant travel disturbance developing quickly. Aggressive, unscheduled maintenance intervention is required to maintain traffic flow and correct unsafe conditions.

**Rockfall-Specific Hazards**

**O. Rockfall Related Maintenance Frequency**

The required frequency of maintenance is an indicator of both rockfall activity and long-term cost to the agency. When there is little to no maintenance required and only scheduled ditch

cleaning required, both maintenance staff and the travelling public are typically not exposed to risk and little cost to the agency is required. As rockfall activity increases at a site, additional surveillance activities specifically checking for rockfall activity may be warranted after storm events and rockfall clean-up activities increase. An example of a rock slope requiring almost daily maintenance attention is shown in the figure below.



**Figure 17. Constant rockfalls occur at this rock slope on the Glenn Highway in Alaska. Maintenance personnel stockpile the daily debris in this pullout for regular removal. This rock cut received a category score of 81.**

Maintenance frequency should be determined through an interview with maintenance personnel, but it can be initially estimated from conditions observed at the site, as in the figure above, but category ratings should be confirmed through discussions with maintenance personnel following field work.

**Table 16. Detailed Rock Slope Rating – Rockfall-Related Maintenance Frequency Category Narratives**

<b>3 points</b>	<u>Normal, scheduled ditch maintenance.</u> Only routine, scheduled ditch maintenance is required on an infrequent (3-5 year) basis. Few, if any rocks accumulate in ditch between maintenance intervals.
<b>9 points</b>	<u>Road Patrols conducted after storm events.</u> Maintenance staff only actively search for rock within the ditch or roadway after extreme storm events. Ditch cleanout of rock debris is infrequently required beyond scheduled ditch cleaning.
<b>27 points</b>	<u>Routine seasonal road patrols.</u> Maintenance staff routinely patrol for rock during typically high rockfall seasons (fall, winter, spring). Ditch cleanout of rock debris is occasionally required beyond scheduled ditch cleaning.
<b>81 points</b>	<u>Year-round road patrols.</u> Maintenance staff routinely patrol for rock year round. Ditch cleanout of rock debris is frequently required beyond scheduled ditch cleaning.



## *Geologic Character*

The geologic conditions of the rockfall section are evaluated with these categories. Since the conditions that cause rockfall generally fit into two categories, Case 1 and Case 2 rating criteria have been developed. Case 1 is for slopes where joints, bedding planes, or other discontinuities are the dominant structural features that lead to rockfall. Case 2 is for slopes where differential erosion or oversteepening is the dominant condition that controls rockfall.

Raters should use the case that best fits the slope for the rating. If both situations are present, and it is unclear which dominates, both can be scored, but only the worst case (highest score) is used in the rating.



**Figure 18. Rock cut where failure is controlled by interaction between geologic structure and rock friction. Forest Service Road 90, Milepost 13.**

### *Case 1*

Rockfall from Case One slopes occurs as a result of movement along discontinuities. The word “joint” as applied here, which represents all possible types of discontinuities, including bedding planes, foliations, fractures, and faults. The term “continuous” refers to joints that are greater than 10 feet in length. The term “adverse” applies not only to the joint's spatial relationship to the slope, but also to such things as rock friction angle, joint infilling, and the effects of water on slope stability, if present. An example of a rock slope in geologic Case 1 is shown in Figure 18.

### *P. Case 1 - Structural Condition*

Jointed rock is typically more prone to rockfall than massive rock. Movement occurs along these joints where the resistance to movement is significantly less than the intact strength of the rock itself. When the joints are orientated adversely to the slope, the potential for rockfall is greater. Adverse joints are those that singularly, or in combination with other joints, make planar, circular, block, wedge or toppling failures kinematically possible.

**Table 17. Detailed Rock Slope Rating – Case 1 Structural Condition Category Narratives**

<b>3 points</b>	<u>Joints with favorable orientations.</u> Slope contains jointed rock with no or very few adversely oriented joints.
<b>9 points</b>	<u>Random (both favorable and unfavorable) orientations.</u> Slope contains randomly oriented joints creating a variable pattern. The slope is likely to have some scattered blocks with adversely oriented joints, but no dominant adverse pattern is present.
<b>27 points</b>	<u>Discontinuous joints with adverse orientations.</u> Rock slope exhibits a prominent joint pattern with an adverse orientation. These features have less than <b>10 feet of continuous length.</b>
<b>81 points</b>	<u>Continuous joints with adverse orientations.</u> Rock slope exhibits a dominant joint pattern with an adverse orientation and a <b>length greater than 10 feet.</b>







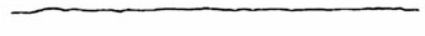

***Q. Case 1 - Rock Friction***

The potential for rockfall caused by movement along discontinuities is controlled by the condition of the joints. The condition of the joints is described in terms of micro and macro roughness. The Joint Roughness Coefficient (JRC) (Barton & Choubey, 1977) can be used as a guide for approximating roughness.

This parameter directly affects the potential for a block to move relative to another. Friction along a joint, bedding plane, or other discontinuity is governed by the macro and micro roughness of the surfaces. Macro roughness is the degree of undulation of the joint relative to the direction of possible movement. Micro roughness is the texture of the surface. Rockfall potential is greater on slopes where the joints contain hydrothermally altered or weathered material, movement has occurred causing slickensides or fault gouge to form, or the joints are open or filled with water.

**Table 18. Detailed Rock Slope Rating – Case 1 Rock Friction Category Narratives**

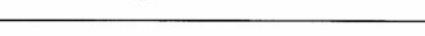
<b>3 points</b>	<u>Rough. Irregular.</u> The surface of the joints is rough and the joint planes are irregular enough to cause interlocking.
<b>9 points</b>	<u>Undulating.</u> Rough but without the interlocking ability, judged on the macro scale.
<b>27 points</b>	<u>Planar.</u> Macro smooth and micro rough joint surfaces. Friction is derived strictly from the roughness of the rock surface.
<b>81 points</b>	<u>Clay Infilling, Open, or Slickensides.</u> Low friction materials separate the rock surfaces, negating any micro or macro roughness of the joint surfaces. Slickensided joints also have a lower friction angle because joint surfaces have been smoothed by movement, whether related to slope stability or tectonic movement.

	JRC = 0 - 2
	JRC = 2 - 4
	JRC = 4 - 8
	JRC = 6 - 8
	JRC = 8 - 10
	JRC = 10 - 12
	JRC = 12 - 14
	JRC = 14 - 16
	JRC = 16 - 18
	JRC = 18 - 20

27  
 .  
 .  
 .  
 .  
 .  
 9  
 .  
 .  
 .  
 .  
 .  
 .  
 .  
 .  
 .  
 3

Approximate rating progression using the JRC as a guide.

**Figure 19. Joint Roughness Coefficient (JRC) guide, modified here as dimensionless. Low JRC values for macro roughness (large planar joints) joints would equate to a higher score. Rough, irregular joints (high JRC), both in macro and micro scale, score low.**

## Case 2

This case is used for slopes where differential erosion or oversteepening is the dominant condition that leads to rockfall. Erosion features include oversteepened slopes, unsupported rock units (overhangs), or exposed resistant rocks on a slope, which may eventually lead to a rockfall event. An example of this geologic case is shown in Figure 20.

### **R. Case 2 - Structural Condition**

Rockfall is commonly caused by erosion that leads to a loss of support, either locally or throughout a slope. The types of slopes that may be susceptible to this condition are: layered geologic units containing more easily erodible units that undermine more durable rock; talus slopes; highly variable geologic units, such as conglomerates, and mudflows, that weather differentially, allowing resistant rocks and blocks to fail, and rock/soil slopes that weather allowing rocks to fall as the soil matrix material is eroded.



**Figure 20. Rock cut where differential erosion is the dominant cause of failure. Forest Service Road 25, Milepost 30.**

**Table 19. Detailed Rock Slope Rating – Case 2 Structural Category Narratives**

<b>3 points</b>	<u>Few Differential Erosion Features.</u> Minor differential erosion features that are not distributed throughout the slope.
<b>9 points</b>	<u>Occasional Differential Erosion Features.</u> Minor differential erosion features that are widely distributed throughout the slope.
<b>27 points</b>	<u>Many Differential Erosion Features.</u> Differential erosion features that are large and numerous throughout the slope.
<b>81 points</b>	<u>Major Differential Erosion Features.</u> Severe cases, such as dangerous erosion-created overhangs, or significantly oversteepened soil/rock slopes or talus slopes.

### **S. Case 2 - Differential Erosion Rate**

The materials comprised in a slope can have markedly different characteristics that control how rapidly weathering and erosion occur. As erosion progresses, resulting in portions of the slope becoming unsupported, the likelihood of a rockfall event increases.

The rate of erosion on a Case 2 slope directly relates to the potential for a future rockfall event. As erosion progresses, unsupported or oversteepened slope conditions develop. The impact of the common physical and chemical erosion processes, as well as the effects of human actions, should be considered. The degree of hazard caused by erosion and thus the score given this category, should reflect the rate at which erosion is occurring; the size of rocks, blocks, or units being exposed; the frequency of rockfall events; and the amount of material released during an event.

**Table 20. Detailed Rock Slope Rating – Case 2 Differential Erosion Rate Category Narratives**

<b>3 points</b>	<u>Small Difference.</u> Erosion features take many years to develop. Slopes that are near equilibrium with their environment are covered by this category.
<b>9 points</b>	<u>Moderate Difference.</u> The difference in erosion rates allows erosion features to develop over a period of a few years.
<b>27 points</b>	<u>Large Difference.</u> The difference in erosion rates allows noticeable changes in the slope to develop annually.
<b>81 points</b>	<u>Extreme Difference.</u> The difference in erosion rates allows rapid and continuous development of erosion features.

## DETAILED RISK RATINGS (ROCKFALL AND LANDSLIDES)

### V. *Route Width or Trail Width*

The roadway or trail width is measured perpendicular to the centerline. This category measures the available maneuvering width of the road or trail, and captures the ability of a traveler to navigate around unforeseen roadway or trail hazards. For example, if a traveler notices rocks in the road, or rocks falling, it is possible for the driver or hiker to react and take evasive action to avoid them. The more room there is for this maneuver on a roadway, the greater the likelihood the driver will successfully miss the rock without hitting some other roadside hazard or oncoming vehicle. For a trail, greater room for maneuvering reduces the likelihood that a user will trip or be compelled to exit the trail in order to avoid the obstacle.

Roadway width is measured as the **available** paved width of the roadway or trail, including paved shoulders as it exists at the time of rating. If paved, the edges of pavement define the roadway. It is difficult to get uniform estimates among different raters about what is unpaved shoulder and what is an unmaneuverable side slope. For that reason, the unpaved shoulders are not included in the measurement. On unpaved routes, such as aggregate or native surface roads or trails, it would be measured as the drivable or navigable width. Where width changes within a section, it should be taken at the narrowest part of the section. On divided roadways, only the portion of the roadway available to the driver for maneuvering should be measured. If the slope is rated while the road is partially closed due to debris or damage, repair of damage to the full width would require a new or updated rating to document the improvement to this unstable slope section.

This category score is based on direct measurements according to the equations below. Graphs of the category scores for roads and for trails are also provided for reference in

*Figure* , and sample calculation results are provided in *Table* .

$$\text{Score} = 3^x \text{ (max 100); where}$$
$$x = \frac{44 - \text{Road width (ft)}}{8} \text{ for vehicles, or } x = \frac{18 - \text{Trail width (ft)}}{4} \text{ for trail traffic}$$

**Equation 5. Roadway Width Score**

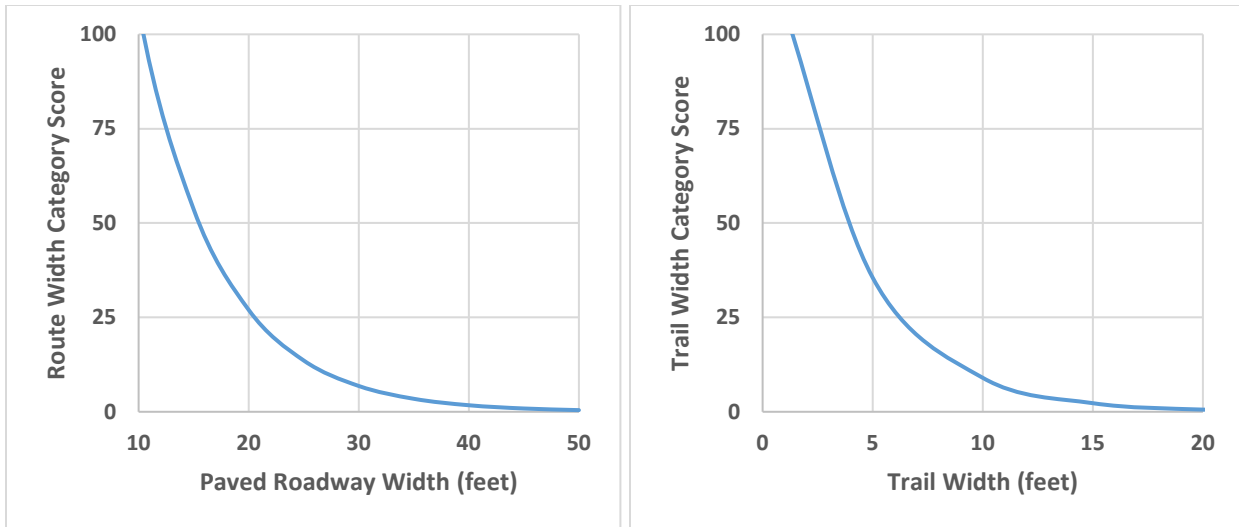

**Figure 21. Chart pair illustrating the relationship between the paved roadway with and the category score and between the trail width and the category score. Note that the category score for paved roadway width maxes out at a width of 10 feet, while the category score for trail width maxes out at a width of 1 foot.**

**Table 21. Risk Rating – Roadway Width Sample Calculated Scores**

	Roadway Width	Trail Width
<b>3 points</b>	36 feet	14 feet
<b>9 points</b>	28 feet	10 feet
<b>27 points</b>	20 feet	6 feet
<b>81 points</b>	12 feet	2 feet

***W. Human Exposure Factor***

The Human Exposure Factor evaluates the potential for a roadway or trail user to be involved in an unstable slope event. This risk is associated with the percentage of time a route user is present in the evaluated section. The percentage is obtained by using the formula based on slope length, average annual daily traffic (AADT), and the posted or advisory speed limit (or average walking speed, 2.7 mph(Knoblach, et al., 1996) at the site. If a different walking speed is entered, note study and/or rationale in the comment field.

A rating of 100% means that, on average, a user will be within the defined unstable section 100% of the time. Where high AADTs or longer slope lengths exist, calculated values can be greater than 100%, meaning that at any particular time, more than one user is present within the measured section. The result also reflects the significance of the route.

This category is scored using direct measurements following the equation below.

$$Score = 3^x \text{ (max 100)}; x = \frac{\left( \frac{AADT}{24} \times slope \text{ length (miles)} \times 100 \right)}{12.5 \times speed \text{ limit or walking speed}}$$

**Equation 6. Human Exposure Factor Score**

**Table 22. Risk Rating – Human Exposure Factor Sample Calculated Scores**

<b>3 points</b>	Human Exposure 12.5% of the time
<b>9 points</b>	Human Exposure 25% of the time
<b>27 points</b>	Human Exposure 37.5% of the time
<b>81 points</b>	Human Exposure 50% of the time

**X. Percent Decision Sight Distance (PDS D) or Avoidance Ability on Trails**

The Percent Decision Sight Distance (PDS D) category compares the amount of sight distance available through an unstable slope section to the optimal sight distance for a speed/path/direction change.

For roadways, sight distance is measured as the length of roadway from when a two-foot object is first seen from a driving position (3.5 feet above the road surface) until the object is reached. Decision sight distance (DSD) is the length of roadway, in feet, required by a driver to perceive a problem and then bring a vehicle to a stop. The required DSD increases with increased vehicle speed and this distance is critical when obstacles in the road surface are difficult to see, or when unexpected or unusual maneuvers are required. Decision sight distances prescribed by AASHTO for rural roads for typical posted speeds are presented in Table 23 below.

**Table 23. AASHTO Recommended Minimum Decision Sight Distance for selected speed limits**

<b>Posted Speed Limit (mph)</b>	<b>AASHTO Recommended Minimum Decision Sight Distance (ft)</b>
25	375
30	450
35	525
40	600
45	675
50	750
55	875
60	1,000
65	1,050



The DSD is critical when obstacles on the road are difficult to see, or when unexpected or unusual maneuvers are required. Throughout an unstable slope section, the sight distance can change appreciably. Horizontal and vertical highway curves along with obstructions such as rock outcrops and vegetation can severely limit a driver’s ability to notice and react to a rock in the road. In calculating this category score, the sight distance is determined in both travel directions, and the most restricted sight distance should be used. Both horizontal and vertical sight distances are evaluated.

The measurement, generally made with a roller tape or laser range finder, is the distance required for a two-foot object positioned on the fog line (or on the edge of pavement if there is no fog line) to disappear from view at an eye height of 3.5 feet above the road surface. The posted, or advisory speed limit throughout the rockfall section is used because unstable slopes are often located within highway curves, where the posted advisory speed limit is lower than the highway design speed. Formally, AASHTO standards require placing the object in the travel lanes and measuring it from a driver’s position near the centerline; however, ratings are typically performed under live traffic and this would be an unsafe practice for both the rater and the public.

For roadways, this category is scored based on direct measurements using the equation below.

$$Score = 3^x; x = \frac{120 - \left( \frac{Measured\ Minimum\ Sight\ Distance}{AASHTO\ Recommended\ Decision\ Sight\ Distance} \times 100 \right)}{20}$$

**Equation 7. Percent Decision Sight Distance Score**

Avoidance ability on trails should be estimated qualitatively based on observations at the time of rating. Since comparable design standards for trails do not exist, the rater should judge the ability of a hiker to avoid a sudden rockfall, broken down into easily, moderately, difficult, or very difficult to avoid. For example, a hiker traversing a trail through a flat grassy area would easily avoid sudden hazards by leaving the trail into predictable surroundings; on a trail next to a shallow stream without a drop off it may be moderately difficult to avoid a hazard; on a boardwalk trail with handrails and a five foot drop to wetlands below it may be difficult to avoid a sudden hazard; and on a narrow trail with a tall cliff below and loose rocks it may be very difficult to avoid a sudden hazard. Below, Table 24 provides the qualitative descriptions and scoring breakdowns for trails, and the calculated value breakdown for roadways based on Equation 7 above.

**Table 24. Risk Rating – Percent Decision Sight Distance Sample Calculated Scores**

	Roadways	Trails
<b>3 points</b>	Adequate, 100% of design value	Hazards easily avoided
<b>9 points</b>	Moderate, 80% of design value	Hazards moderately difficult to avoid
<b>27 points</b>	Limited, 60% of design value	Hazards difficult to avoid
<b>81 points</b>	Very Limited, 40% of design value	Hazards very difficult to avoid

**Y. Right of Way Impacts if Left Unattended**

Adjacent land owners may be impacted by unstable slopes retrogressing to property boundaries and beyond. If structures or other transportation systems are potentially impacted by unstable slopes, then the risk to the agency increases. Maps displaying right of way (ROW) are helpful when performing evaluations.

To offer additional flexibility in this rating category for other agency or department facility assets beside roads and trails, raters may opt to use this category to evaluate the impact of landslides or rockfall on their built infrastructure. For instance, where no facilities are in harm's way, 3 points would be scored. Minor, easily replaceable facilities, such as benches or railings could be 9 points. Retaining walls, bear boxes, or drinking fountains could be 27 points, and 81 points could be assigned to significant structures such as ranger stations, restrooms, or other occupied structures.

**Table 25. Risk Rating – Right of Way Impacts Category Narratives**

<b>3 points</b>	<u>No ROW implications.</u> Unstable slopes very unlikely to extend beyond agency ROW.
<b>9 points</b>	<u>Minor effects beyond ROW.</u> Retrogressing unstable slopes impacting non-agency ROW, but adjoining landowner indifferent to minor impacts. Minor impacts include overburden slumping, minor drainage changes, or rock slope crest retrogression.
<b>27 points</b>	<u>Private property, no structures affected.</u> Unstable slopes actively retrogressing into private property but not impacting or likely to threaten structures. ROW acquisition of private lands may be a remote option.
<b>81 points</b>	<u>Structures, roads, RR, utilities, or parks affected.</u> Retrogressing unstable slopes actively threatening adjacent structures, transportation systems, or Federal or State Park lands. In this score range, ROW acquisition of private lands may be a viable option. Coordination of mitigation approaches with outside agency landowner(s) will likely be required.

**Z. Environmental/Cultural Impacts if Left Unattended**

If the unstable slope is left unattended, impacts to the environment or cultural resources may occur. These impacts can include siltation of streams, culvert plugging, subsequent fish passage blocking, habitat impacts, or damage to historic features or sites. Due to the highly variable nature of potential environmental impacts, a range of environmental and cultural descriptions are used for this category. The rater should select the category containing the highest environmental or cultural impact if left unattended. If these impacts are anticipated, a review by environmental and/or cultural resource professionals may be recommended.

Preservation of paleontological resources, which is mandated by law, should also be considered in this category and separated similarly to the rating categories provided for environmental and cultural impacts presented in Table 26.

**Table 26. Risk Rating – Environmental/Cultural Impacts Category Narratives**

<b>3 points</b>	<u>None/No potential to cause effects.</u> No known sensitive environmental issues are present or anticipated if a <i>probable</i> worst-case scenario occurs. Hazard does not have the potential to cause effects on historic properties, assuming such historic properties are present (36 CFR 800.3(a)(1)).
<b>9 points</b>	<u>Likely to affect/No historical property affected.</u> If a probable or historically common failure occurs or the slope retrogresses, minor environmental impacts are anticipated, but adverse impacts are not anticipated. Historic properties are present but the hazard will have no effect upon them (36 CFR 800.4(d)(1))
<b>27 points</b>	<u>Likely to Adversely Affect/Finding of No Adverse Effect.</u> If a probable or historically common failure occurs or the slope retrogresses adverse impacts are anticipated. Historic properties are present but the hazard will require modification or conditions imposed should the hazard continue untreated (36 CFR 800.5(a)(2)(vii)(b)).
<b>81 points</b>	<u>Current adverse effects/Adverse Effect.</u> Current conditions are causing adverse environmental effects. An adverse effect is found when an undertaking may alter, directly or indirectly, any of the characteristics of a historic property (36 CFR 800.5(a)(1)).

**AA. Maintenance Complexity**

Complexity of maintenance following routine and/or a *probable* worst case scenario rockfall or landslide event is indicative of the maintenance costs and associated hazards. Maintenance could be as simple as cleaning rocks off the road during routine road patrols or as complex as the maintenance of unstable slope remediation systems, such as rockfall attenuator fences or construction of mechanically stabilized earth (MSE) walls to remediate an embankment landslide. This information should be gathered during the interview of maintenance personnel, specifically what the personnel capabilities and equipment is available to the agency to perform maintenance activities in the rating corridors.

**Table 27. Risk Rating – Maintenance Complexity Category Narratives**

<b>3 points</b>	<u>Routine effort/in-house.</u> Maintenance staff typically deal with unstable slopes with road-going equipment such as a pickup with a blade, particularly effective with rockfall incidences. Trails require typical maintenance activities.
<b>9 points</b>	<u>In-house maintenance/special project.</u> Maintenance of the site requires mobilization of specialized equipment such as a backhoe, excavator, paver, or guardrail post driver. Trails may require blasting and/or geotextile fabrics with existing surface materials to maintain the trail route and width.
<b>27 points</b>	<u>Specialized equipment/contract.</u> Maintenance requires specialized equipment to be mobilized a significant distance or requires assistance from an outside contractor. More involved maintenance may require basic engineering efforts (such as subgrade design or asphalt mixes). This would be similar for trails, such as renting a trail excavator and small dump to haul materials and may require basic engineering efforts (such as short retaining walls or realignments of trail sections).
<b>81 points</b>	<u>Complex or dangerous effort/location/contract.</u> Specialty contractor is required to perform maintenance activities (such as maintaining rockfall attenuator fences); more complex maintenance designs (such as subgrade reinforcement, tall MSE walls, or rockfall mitigation) requiring geotechnical design efforts; or difficult/dangerous access (rope access, spider hoe) is required.

**BB. Event Cost**

The estimated, or actual cost if available, to maintain or repair a *probable* worst-case scenario or a historically bad failure should be considered. The costs should be considered at comparable private-sector equipment rental and operator rates. If an extreme event requires outside assistance (planning, design, and/or construction) the costs should include both those outside costs and the agency contracting and supervisory costs. These rating categories are based on typical spending and contractual authorities in Federal agencies and departments. Again, interviewing maintenance personnel to determine the previous expenditures for similar unstable slope work proposed can be very helpful when teamed with a brief field review of the unstable slope sites to determine the likely, and appropriate rating for this category.

**Table 28. Risk Rating – Event Costs Category Narratives**

<b>3 points</b>	<u>\$0-2k</u> . Maintenance efforts and costs involve only agency maintenance staff using existing equipment. No design work required.
<b>9 points</b>	<u>\$2-25k</u> . Event cost and response is more involved and may include input from agency engineering staff.
<b>27 points</b>	<u>\$25-100k</u> . Costs indicate extensive, multi-day efforts and likely input from engineering staff. Costs may include outside contractors and engineering costs.
<b>81 points</b>	<u>\$ &gt;100k</u> . Large contract with significant outside contractor and engineering costs.

## REFERENCES FOR APPENDIX A

- Barton, N. & Choubey, V., 1977. The Shear Strength of Rock Joints in Theory and Practice. *Rock Mechanics and Rock Engineering*, 10(1), pp.1-54.
- Cornforth, D., 2005. *Landslides in Practice*. Wiley & Sons.
- Cruden, D.M. & Varnes, D.J., 1996. Landslide Types and Processes. In A.K. Turner & R.L. Schuster, eds. *Landslides: Investigation and Mitigation*. Washington D.C.: Transportation Research Board, National Research Council. pp.36-75.
- Hoek, E. & Bray, J.D., 1981. *Rock Slope Engineering: Third Edition*. London and New York: Institute of Mining and Metallurgy.
- Knoblauch, R.L., Pietrucha, M.T. & Nitzburg, M., 1996. Field Studies of Pedestrian Walking Speed and Start-Up Time. *Transportation Research Record: Journal of the Transportation Research Board*, pp.27-38.
- Transportation Research Board, 1996. *Landslides: Investigation and Mitigation: Special Report 247*. Special Report 247. National Research Council.

## **APPENDIX B. USMP RATING FORMS**

This Appendix contains four forms developed for this project:

- Slope Rating Form
- New Slope Event Form
- Maintenance Form
- Conceptual Design and Cost Estimate Form

## SLOPE RATING FORM – SITE INFORMATION

ITALICIZED DATA CATEGORIES REQUIRED FOR FULL RATING

<b>Management Area:</b>				<b>Date:</b>	
<b>Hazard Type (select all that apply within one of the categories):</b>		<b>Rockfall</b> Planar   Wedge   Toppling   Raveling/Undermining   Rock Avalanche   Indeterminate Rock Failures   Differential Erosion		<b>Landslide</b> Above, Below, or Across Route Translational   Rotational   Debris Flow   Shallow Slump   Erosional Failure	
<b>Road/Trail No.:</b>		<input type="radio"/> Trail <input type="radio"/> Road		<b>Road/Trail Class:</b>	
<b>Beginning Mile Marker:</b>		<b>Ending Marker:</b>		<b>Side:</b>	
<b>Begin Lat. (xx.xxxxx):</b>		<b>End Lat. (xx.xxxxx):</b>		<b>Datum:</b>	
<b>Coord.: Long. (-xxx.xxxxx):</b>		<b>Coord.: Long. (-xxx.xxxxx):</b>		<b>AADT:</b>	
<b>Length of Affected Road/Trail (ft):</b>		<b>Slope Height (rock) /Axial Length (slide) (ft):</b>		<b>Slope Angle (°):</b>	
<b>Sight Distance (ft):</b>		<b>Usable Roadway/Trail Width (ft):</b>		<b>Speed Limit (mph):</b>	
<b>Ditch Width (ft):</b> RANGE <small>ROCKFALL</small>		<b>Ditch Depth (ft):</b> RANGE <small>ROCKFALL</small>		<b>Ditch Slope (H:V):</b> RANGE <small>ROCKFALL</small>	
<b>Annual Rainfall (in):</b> RANGE		<b>Sole Access Route</b> <input type="checkbox"/> Yes <input type="checkbox"/> No		<b>Fixes Present</b> <input type="checkbox"/> Yes <input type="checkbox"/> No	
				<b>Photo # Range:</b>	

**Comments:**

### PRELIMINARY RATING

Category Rating	3	9	27	81	Score
<b>A. Landslide – Roadway Width Affected</b>	0-5 Percent	6-25 Percent	26-50 Percent	51-100 Percent	
<b>B. Landslide – Slide/Erosion Effects</b>	Visible crack or slight deposit of material / minor erosion	1 inch offset, or 6-inch deposit of material / major erosion will affect travel in < 5 yrs	2-inch offset or 12-inch deposit/ mod. erosion impacting travel annually	4-inch offset or 24-inch deposit/ severe erosion impacting travel consistently	
<b>C. Landslide – Roadway Length Affected</b>	25 ft	100 ft	225 ft	400 ft	<i>CALC</i>
<b>D. Rockfall – Ditch Effectiveness</b> <small>(consider launch features)</small>	Good	Moderate	Limited	No Catchment	
<b>E. Rockfall – Rockfall History</b>	Few Falls	Occasional Falls	Many Falls	Constant Falls	
<b>F. Rockfall – Block Size or Volume per Event</b>	1 ft or 3 yd <sup>3</sup>	2 ft or 6 yd <sup>3</sup>	3 ft or 9 yd <sup>3</sup>	4 ft or 12 yd <sup>3</sup>	<i>CALC</i>
<b>G. All – Impact on Use</b>	Full use continues with minor delay	Partial use remains Use modification required, short (3 mi/30 min.) detour available	Use is blocked – long (>30 min) detour available or less than 1 day closure	Use is blocked – no detour available or closure longer than 1 week	
<b>H. All – AADT / Usage / Economic or Recreational Importance (highest rating applies)</b>	50 Rarely Used Insignificant economic / rec. importance	200 Occasionally used Minor economic / rec. importance	450 Frequently used Moderate economic / rec. importance	800 Constantly used Significant economic / rec. importance	<i>CALC FOR AADT ONLY</i>
<b>LANDSLIDES TOTAL (A+B+C+G+H)</b>					<i>CALC</i>
<b>ROCKFALL TOTAL (D+E+F+G+H)</b>					<i>CALC</i>

**Preliminary Rating** Good (15-21 pts) | Fair (22-161 pts) | Poor (>161 pts)  
 Sites rated as Fair or Poor receive detailed evaluation (complete back page)

**SLOPE RATING FORM – DETAILED SLOPE HAZARD RATING**

Category Rating		3	9	27	81	Score			
<b>I. All – Slope Drainage</b>		Slope appears dry or well drained; surface runoff well controlled	Intermittent water on slope; mod. well drained; or surface runoff moderately controlled	Water usually on slope; poorly drained; or surface runoff poorly controlled	Water always on slope; very poorly drained; or surface water runoff control not present				
<b>J. All – Annual Rainfall</b>		0-10"	10-30"	30-60"	60"+				
<b>K. All – Slope Height (rockfall) / Axial length of slide (landslide)</b>		25 ft	50 ft	75 ft	100 ft	CALC			
<b>Select One Unstable Slope Type</b>	<b>Landslides/ Erosion (add A, B, C)</b>	<b>L. Thaw Stability (cold climates)</b>		Unfrozen/Thaw Stable	Slightly Thaw Unstable	Moderately Thaw Unstable	Highly Thaw Unstable		
		<b>M. Instability-Related Maint. Frequency</b>		Every 10 years	Every 5 years	Every 2 years	Every year		
		<b>N. Movement History</b>		Minor movement or sporadic creep	Up to 1 inch annually or steady annual creep	Up to 3 inches per event, one event per year	>3" per event, >6" annually, more than 1 event per year (includes all debris flows)		
	<b>Rockfalls (add D, E, F)</b>	<b>O. Rockfall-Related Maint. Frequency</b>		Normal, scheduled maintenance	Patrols after every storm event	Routine seasonal patrols	Year-round patrols		
		<b>Geologic Character</b>	<b>Case 1</b>	<b>P. Structural Condition</b>	Favorable	Random	Adverse Discontinuous	Adverse Continuous	
				<b>Q. Rock Friction</b>	Rough/Irregular	Undulating	Planar	Clay infilled/Slickensided	
		<b>Case 2</b>	<b>R. Structural Condition</b>	Few differential erosion features	Occasional differential erosion features	Many differential erosion features	Major differential erosion features		
			<b>S. Diff. in Erosion Rates</b>	Small difference	Moderate difference	Large difference	Extreme difference		
	<b>T. LANDSLIDE HAZARD TOTAL (A+B+C+I+J+K+L+M+N)</b>						CALC		
	<b>U. ROCKFALL HAZARD TOTAL (D+E+F+I+J+K+O+(greatest of P+Q or R+S))</b>						CALC		
<b>DETAILED RISK RATING</b>									
<b>V. Route Width or Trail Width</b>		36 ft 14 ft	28 ft 10 ft	20 ft 6 ft	12 ft 2 ft	CALC			
<b>W. Human Exposure Factor</b>		12.5% of the time	25% of the time	37.5% of the time	50% of the time	CALC if AADT avail			
<b>X. % of Decision Sight Distance (Judge avoidance ability on trails)</b>		Adequate, 100% of low design value	Moderate, 80% of low design value	Limited, 60% of low design value	Very Limited, 40% of low design value	CALC for roads			
<b>Y. Right of Way (R/W) Impacts (If Left Unattended)</b>		No R/W implications	Minor effects beyond R/W	Private property, no structures affected	Structures, roads, RR, utilities, or Parks affected				
<b>Z. Environmental/Cultural Impacts if Left Unattended</b>		None/No potential to cause effects	Likely to effect/No hist. prop. affected	Likely to adversely affect/Finding of no adverse effect	Current adverse effects/Adverse effect				
<b>AA. Maintenance Complexity</b>		Routine effort/In-House	In-House Maint./Special project	Specialized equip./contract	Complex/Dangerous effort/location/contract				
<b>BB. Event Cost</b>		\$0-2k	\$2-25k	\$25-100k	>\$100k				
<b>CC. RISK TOTALS: (G+H+V+W+X+Y+Z+AA+BB)</b>						CALC			
<b>TOTAL USMP SCORE: LANDSLIDES (T+CC) OR ROCKFALL (U+CC)</b>						CALC			
<b>Total USMP Score</b> Good (< 200 pts)   Fair (200 - 400 pts)   Poor (> 400 pts)									



For the directly measurable categories, use the following formulas to **calculate the exponent value (x) for the scoring formula  $y = 3^x$** . This will allow the calculation of a precise score for the category measurement and development of category scoring tables.

**C. Length of roadway affected exponent:**

$$x = \sqrt{\frac{\text{length affected}}{25}}$$

**F. Block size or the volume exponent formula:**

$$\begin{aligned} \text{block size } x &= \text{block size} \\ \text{volume } x &= \left(\frac{\text{yds}^3}{3}\right) \end{aligned}$$

**H. AADT exponent formula:**

$$x = \sqrt{\frac{\text{AADT}}{50}}$$

**K. Slope height/axial slide length exponent formula:**

$$x = \frac{\text{slope height}}{25}$$

**V. Width exponent formula:**

$$x = \frac{44 - \text{Road width (ft)}}{8} \text{ for vehicles, or } x = \frac{18 - \text{Trail width (ft)}}{4} \text{ for trail traffic}$$

**W. Human exposure factor exponent formula for roads and trails:**

$$x = \frac{\left(\frac{\text{AADT}}{24} \times \text{slope length (miles)} \times 100\right)}{\text{speed limit or walking speed}}}{12.5}$$

**X. Percent decision sight exponent formula:**

$$x = \frac{120 - \left(\frac{\text{measured sight distance}}{\text{AASHTO decision sight distance}} \times 100\right)}{20}$$

**NEW SLOPE EVENT FORM – OBSERVER INFORMATION**

<b>Observer Name:</b>		<b>Today's Date:</b>
<b>Phone No.:</b>	<b>Email:</b>	
<b>Date of Event:</b>	<b>About Date of Event (circle one):</b> Known, Approximate, Unknown	
<b>Observer Comments/Sketch:</b>		

**EVENT INFORMATION**

<b>Road/Trail No.:</b>	<input type="radio"/> Trail <input type="radio"/> Road	<b>State:</b>	
<b>Hazard Type (select all that apply):</b> Rockfall   Landslide/Erosion   Debris Flow   Snow Avalanche			
<b>Beginning Mile Marker:</b>	<b>Ending Mile Marker:</b>	<b>Photo # Range:</b>	
<b>Event Coord.</b>	<b>Latitude (xx.xxxxx):</b> <b>Longitude (-xxx.xxxxx):</b>	<b>Datum:</b>	<b>Length of Affected Road/Trail (ft): (1m = 3 ft):</b>
<b>Road/Trail Conditions after Failure:</b> Blocked   Blocked/Detours exist around failure   Partially blocked but passable   Ditch full of debris   Route threatened by unstable slope			

<b>Size of Largest Fallen Rock:</b>	<b>No. of Rocks:</b>	<b>Estimated Volume of Debris:</b>
<input type="radio"/> Less than 3 inches (< 8 cm) - baseball size or smaller <input type="radio"/> Less than 1 foot (< 30 cm) - basketball size or smaller <input type="radio"/> 1 to 3 feet (30 - 100 cm) - fits through standard doorway <input type="radio"/> Greater than 3 feet (> 1 m) thousands of pounds	<input type="radio"/> 1 <input type="radio"/> 2 <input type="radio"/> 3 - 5 <input type="radio"/> 5 - 10 <input type="radio"/> 10+	<input type="radio"/> < 5 ft <sup>3</sup> (< 0.15 m <sup>3</sup> ) – wheelbarrow or less <input type="radio"/> < 2.5 yd <sup>3</sup> (< 2 m <sup>3</sup> ) – pickup truck or less <input type="radio"/> < 10 yd <sup>3</sup> (< 8 m <sup>3</sup> ) – dump truck or less <input type="radio"/> > 10 yd <sup>3</sup> (> 8 m <sup>3</sup> ) – several dump trucks

<b>Description of Event Location (select all that apply):</b>	<b>Possible Cause of Event (select all that apply):</b>
<input type="radio"/> Above road/trail <input type="radio"/> Below road/trail <input type="radio"/> At a culvert <input type="radio"/> Above river <input type="radio"/> Above coast <input type="radio"/> Burned area <input type="radio"/> Deforested slope <input type="radio"/> Urban <input type="radio"/> Mine <input type="radio"/> Retaining wall <input type="radio"/> Natural slope <input type="radio"/> Engineered slope <input type="radio"/> Unknown <input type="radio"/> Other (Please describe in Observer Comments)	<input type="radio"/> Rain <input type="radio"/> Thunderstorm/downpour <input type="radio"/> Continuous rain (> than 24 hours) <input type="radio"/> Hurricane/cyclone <input type="radio"/> Flooding <input type="radio"/> Snowfall/snowmelt <input type="radio"/> Prolonged freezing <input type="radio"/> High temperatures <input type="radio"/> Other (Please describe in Observer Comments) <input type="radio"/> Long-term creep/poor soil cond. <input type="radio"/> Earthquake <input type="radio"/> Volcanic activity <input type="radio"/> Leaking pipe <input type="radio"/> Mining <input type="radio"/> Construction <input type="radio"/> Dam embankment collapse <input type="radio"/> No obvious cause <input type="radio"/> Unknown cause

<b>Did deaths, injuries, or damages coincide with the landslide/rockfall?</b> <input type="radio"/> Yes <input type="radio"/> No If yes, please describe:
--

**MAINTENANCE FORM – SITE INFORMATION**

<b>Facility Index Code Relationship/Job Code Tracking (Optional):</b>		<b>Maintenance Type:</b> <input type="radio"/> New Maintenance <input type="radio"/> Repeat Maintenance (within 5 years)
<b>Beginning Mile Marker:</b>	<b>Ending Mile Marker:</b>	
<b>Maintenance Event Coordinates:</b>	<b>Latitude (xx.xxxxx):</b>	<b>Longitude: (-xxx.xxxxx):</b>
<b>Road or Trail Number:</b>	<b>Site ID:</b>	<b>Date(s) of Maintenance:</b>
<b>Type of Event:</b> <input type="radio"/> Recent Unstable Slope Event <input type="radio"/> Routine Maintenance <input type="radio"/> Slope Mitigation/Repair	<b>Agency Information:</b>	<b>Notes:</b>
<b>Description of Events/Activities:</b>		
<b>Estimated total cost of the maintenance activity:</b>		<b>\$</b>
<b>Action</b>		<b>Cost (%)</b>
<b>Design, PS&amp;E:</b>		
<b>Removing debris from the road ditch and/or maintaining other drainage features:</b>		
<b>Removing debris from the roadway or trail:</b>		
<b>Re-leveling roadway (aggregate):</b>		
<b>Re-leveling roadway (asphalt patch):</b>		
<b>Constructing a drainage improvement:</b>		
<b>Constructing a deep patch:</b>		
<b>Hauling debris away from the site:</b>		
<b>Scaling of unstable rock slopes:</b>		
<b>Minor shifting of roadway/trail alignment:</b>		
<b>Repair of rockfall barrier:</b>		
<b>Repair of rockfall netting (on-slope):</b>		
<b>Sealing cracks in pavement:</b>		
<b>Installing, maintaining, or replacing guardrail:</b>		
<b>Cleaning and/or maintaining horizontal drains and associated subsurface drainage:</b>		
<b>Flagging and signing:</b>		
<b>Other (enter description):</b>		
<b>Other (enter description):</b>		
<b>Other (enter description):</b>		
<b>Other (enter description):</b>		
<b>Running total of the cost percentages:</b>		

**CONCEPTUAL DESIGN AND COST ESTIMATE FORM – UNSTABLE SLOPE SITE INFORMATION**

<b>Management Area:</b>	<b>Date:</b>
-------------------------	--------------

<b>Road/Trail No.:</b>	<input type="radio"/> Trail <input type="radio"/> Road	<b>Created By:</b>
------------------------	---	--------------------

<b>Beginning MP:</b>	<b>Ending MP:</b>	<b>Side:</b>	<b>Weather:</b>
----------------------	-------------------	--------------	-----------------

<b>Hazard Type (select all that apply within one of the categories):</b>	<b>Rockfall</b> Planar   Wedge   Toppling   Raveling/Undermining   Rock Avalanche   Indeterminate Rock Failures   Diff. Erosion	<b>Landslide</b> Above, Below, or Across Route Translational   Rotational   Debris Flow   Shallow slump   Erosional Failure
--	---	--

<b>Previous Total Rating:</b>	<b>Previous Rating Agency:</b>	<b>Previous Rating Date:</b>
-------------------------------	--------------------------------	------------------------------

<b>Current Rating (if re-rated):</b>	<b>Photo # Range:</b>
--------------------------------------	-----------------------

**Problem Statement:**

**Proposed Correction:**

**ESTIMATING FACTORS**

Item	Unit	Amount Required	Unit Cost	Total Cost
				\$ 0.00
				\$ 0.00
				\$ 0.00
				\$ 0.00
				\$ 0.00
				\$ 0.00
				\$ 0.00
				\$ 0.00
				\$ 0.00
				\$ 0.00
				\$ 0.00
				\$ 0.00
				\$ 0.00
				\$ 0.00
<b>ESTIMATED TOTAL COST</b>				<b>\$0.00</b>

## APPENDIX C. DETAILED INSTRUCTIONS FOR USMP WEBSITE AND MOBILE APPLICATIONS

This appendix details how to use the USMP website and the USMP iOS/Android mobile applications. The first section describes how to use the USMP website, including step-by-step instructions on how to create, edit, and save slope rating forms, new slope event forms, and maintenance forms. The second section describes how to use the USMP iOS/Android apps for the similar tasks.

### USING THE USMP WEBSITE

To login to the USMP website, visit <https://usmp.info/> and input your username and password. New users will need to obtain a username and password to begin from the appropriate agency manager. There are several options listed in the task bar near the top of the website. Each of these options (Map, Slope Rating Form, New Slope Event Form, Maintenance Form, QRA, Account, and Logout) link you to specific functions within the USMP website, which are described in greater detail below. Information on the USMP project including links to training videos, presentations, forms and the field manual can be accessed through the “About” link on the USMP homepage.

### Map

Google™ maps is the platform that is used to graph the information collected in the USMP. It is also where information can be searched and downloaded from the database (search process is described below). Also, new forms can be added based on location by clicking on the area of interest as described below.

### Slope Rating Form

To begin a new rating form for a site, click on ‘Slope Rating Form’ on the navigation bar at the top of the webpage. Doing this will open a new slope rating form, as illustrated in Figure 1.

**Figure 1. Top of Slope Rating Form on USMP website.**

Map	Slope Rating Form	New Slope Event	Maintenance Form	QRA	Account	Logout
<b>Site Information</b>						
<b>Agency Information:</b> Select Agency option ▼ Select Regional option ▼ Select Local option ▼		Date: 2017-01-25 11:43:39	<input type="radio"/> Rockfall <input type="radio"/> Landslide		Hazard Type: -- ▼	
Road/Trail No: <input type="text"/>	Road/Trail: ▼	Road/Trail Class: <input type="text"/>	Rater: <input type="text"/>			
Beginning Mile Marker: <input type="text"/>	Ending Mile Marker: <input type="text"/>	Side: ▼	Weather: Unknown ▼			

Fill in all the text and number fields, radio buttons, drop down options with related information as part of the rating process. If any **required** field is left empty or is filled with invalid information, an error message will automatically appear, and incorrect fields will be highlighted red, as shown in Figure 2. A list of required fields and their value restrictions are as follows:

- Management Area must be specified by selecting Agency from the drop down, then State/Region/Territory, then Local/County/Territory
- Date must be specified in either 'YYYY-MM-DD' or 'YYYY-MM-DD HH:MM:SS' formats. The date is auto-filled at the time the form is loaded, but may be modified to reflect the date of a field rating.
- Either Rockfall or Landslide must be selected.
- Hazard Type must have a value, or multiple values selected from the multi-select list. The list is populated based on the Rockfall/Landslide selection.
- Road/Trail No. cannot be empty and must be shorter than 30 characters.
- Road/Trail must be selected.
- Road/Trail Class cannot be empty and must be shorter than 30 characters.
- Rater cannot be empty and must be shorter than 30 characters.
- Beginning Mile Marker and Ending Mile Marker must have a non-negative decimal value.
- Side must be selected.
- Weather must be selected.
- Beginning and Ending Coordinates Latitude must be floating point values.
- Beginning and Ending Coordinates Longitude must be floating point values.
- AADT must have a non-negative integer value
- Length of Affected Road/Trail must have a non-negative decimal value.
- Slope Height (rock)/Axial Length (slide) must have a non-negative decimal value.
- Slope Angle must have an integer value between 0 and 90 degrees.
- Sight Distance must have a non-negative decimal value.
- Roadway/Trail width must have a non-negative decimal value.
- Speed Limit must have a non-negative integer value.
- Ditch Width minimum and maximum must have non-negative decimal values.
- Ditch Depth minimum and maximum must have non-negative decimal values.
- Ditch Slope beginning and ending horizontal and vertical cells must all have non-negative decimal values.
- Block Size or Volume must have a non-negative decimal value.
- Volume must have a decimal value.
- Annual Rainfall minimum and maximum must have non-negative decimal values.
- Sole Access Route must be selected.
- Mitigation Present must be selected.



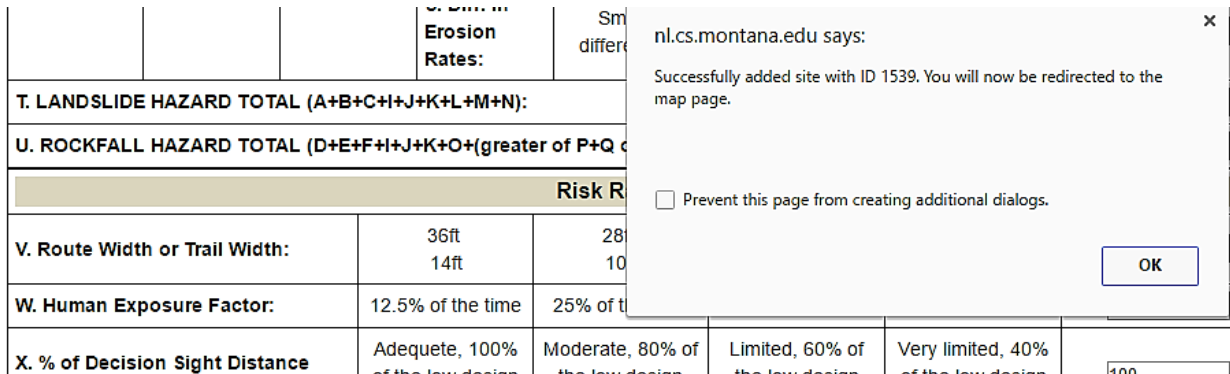

**Figure 4. Example success message during submission process.**

To view or edit an existing site on the USMP website, begin by clicking on “Map” in the navigation bar. Be patient as the site loads all the unstable slope information, which can take up to 10 seconds or more for the icons to appear. Rated sites will appear on the map as a rockfall or landslide icon in one of three colors (green, yellow or red) depending on the rating score. A pop-up window containing selected information about a particular site can be opened by simply clicking on the icon of interest. Several hyperlinks are included in each pop-up window. The existing slope rating form can be opened by clicking on the hyperlink, and users can view and/or edit the fields of the opened slope rating form. Clicking on the “Submit” button will save any new changes made to the form and generate a new edit record that will show up in the popup the next time it is opened. After submitting the data, you will need to have administrative rights to make changes to the data later.

### **New Slope Event Form**

A new slope event form can be created using one of two methods. One method is to select ‘New Slope Event Form’ on the navigation bar. An alternate method is to navigate to the Map page and create a new slope event using geographic information. First, the map must be set to display only new slope event information. To do this, select “New Slope Event Information Search” from the first dropdown menu. The next step is to right click on the desired location in the map to create a location pin. Left clicking on this pin will open a pop-up that contains a hyperlink with the text “Add New Slope Event.” Click on this hyperlink to create a New Slope Event associated with that location. Fill in the text fields, radio buttons, check boxes, and drop down options with relevant information in the new slope event form, and click the “Submit” button at the bottom of the form when finished. As with the rating form, if any of the required fields are empty or filled with incorrectly formatted information, an error message will be displayed and incorrect fields will be highlighted red. If the form entries are properly filled in, a message will be displayed indicating that the information was successfully added.

Required fields:

- About Date of Event must be selected.
- Date must be selected using the calendar select popup.



- One or more hazard types must be selected.
- Latitude and Longitude must have floating point values.
- Road/Trail must be selected.

## Maintenance Form

### *Creating a New Maintenance Form for an Existing Site*

To add a New Maintenance Form for an existing site (i.e., a site that has already been rated), click on the icon of the desired unstable slope site on the map. A pop-up window will open which includes a hyperlink labeled “Add new maintenance form” (see illustration in Figure 5). Clicking on this hyperlink will open a New Maintenance Form. If a particular site is desired, the “Select Search and Reporting Option” dropdown tool in the upper left of the “Map” page can be used to find a specific site ID or other distinguishing feature. Once found, the Maintenance form can be completed. Maintenance forms that are associated with an existing (rated) site are shown as blue pins.

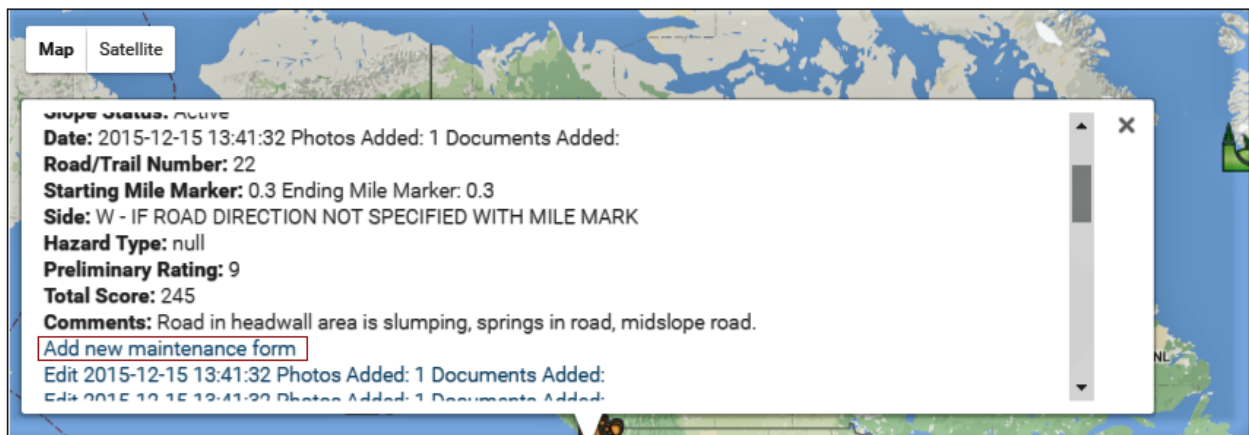

**Figure 5. Illustration of access to New Maintenance Form through pop-up associated with existing site.**

Click the **Submit** button at the bottom of the form when the form is complete. If any of the required fields are empty or filled with incorrectly formatted data, an error message will be displayed under the submit button, and all affected fields will be highlighted red. If the form entries are correct then a message indicating successful saving to the database will appear. After clicking on the OK button, it will automatically redirect the Maintenance Form page back to the Map page.

Required fields:

- Select Agency must be selected.
- Select State/Region must be selected.
- Select Local/County must be selected.
- Estimated total cost must have a non-negative numeric value.
- Maintenance Coordinate Latitude must have a floating point value.

- Maintenance Coordinate Longitude must have a floating point value.
- Running total of the cost percentages should be equal to 100.

### ***Creating a New Maintenance Form That is Not Associated with an Existing Site***

One of two methods can be used to create a new maintenance form for a site that has not been previously rated. The first method is to simply click on the “Maintenance Form” tab from the navigation bar. This will open a blank Maintenance Form that can be filled out with location data and submitted. An alternate method is to navigate to the Map page and create a maintenance event using geographic information. First, the map must be set to display only maintenance information. To do this, select “Maintenance Information Search” from the upper left dropdown menu on the Map page. The next step is to right click on the desired location in the map to create a location pin. Left clicking on this pin will open a pop-up that contains a hyperlink with the text “Add New Maintenance Form,” as illustrated in Figure 6. Click on this hyperlink to create a new Maintenance Event associated with that location. Add the information to the form as described above and save the information to the database by clicking the **submit** button. When submitted, the maintenance pin for sites that are not associated with a rated site are white. This color distinction (blue and white pins) was included to alert unstable slope managers within agencies to the unstable slopes that may be new and require a slope rating.

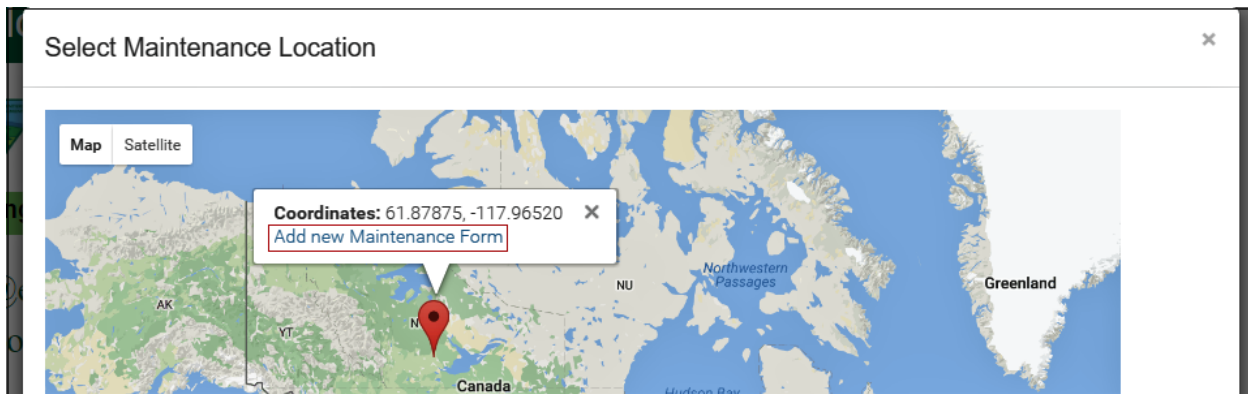

**Figure 6. Illustration of access to New Maintenance Form through setting of geographic pin.**

### ***View/Editing an Existing Maintenance Form***

To view/edit any existing maintenance form, navigate to the Map page and select the “Maintenance Information Search” option from the upper left search drop down. Click on the icon for the desired maintenance site on the map, which will open a pop-up window that lists all the maintenance form edits by date and time stamp for that particular site as shown in Figure 7. Select the hyperlink for the specific maintenance form edit to open an existing Maintenance Form. After making the necessary changes, click on the submit button to save the new form and its changes to the database.

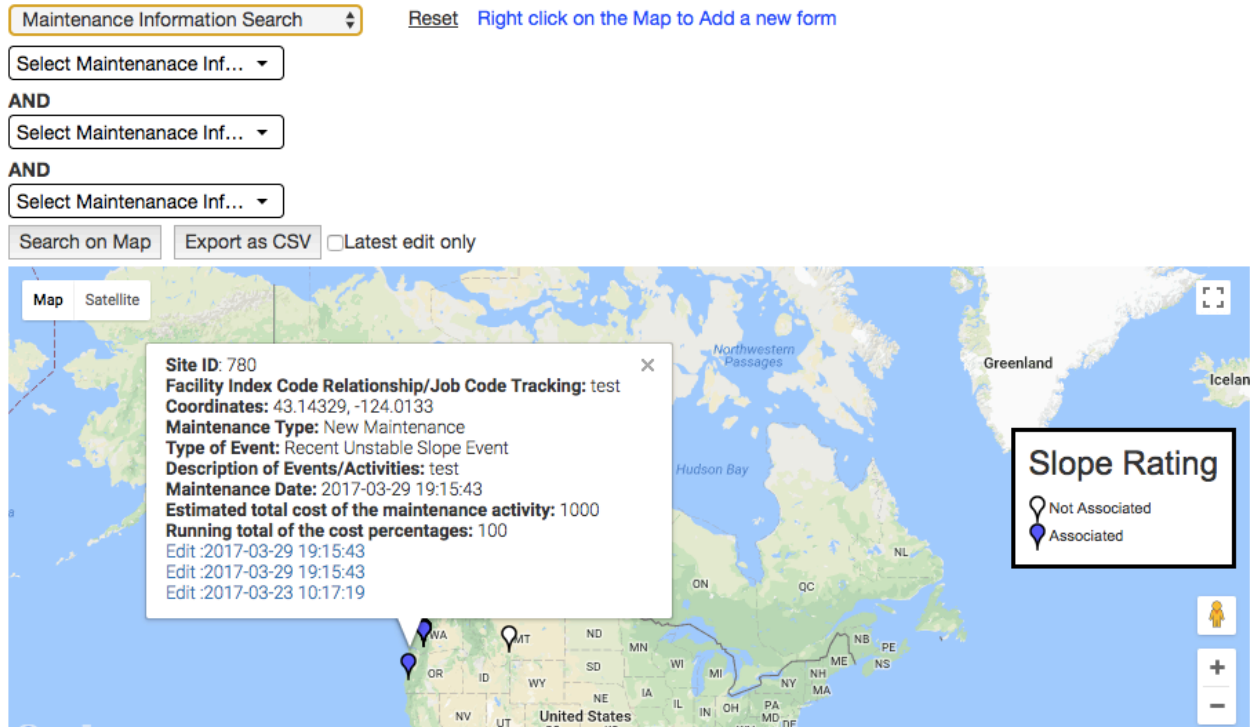

**Figure 7. Pop-up associated with maintenance pin.**

## QRA

The quantitative risk analysis (QRA) web page is designed to help users analyze risk associated with unstable slopes. Calculations are automatically made using information entering into the cells. Individual entries into each of these cells are stored in the URL for this website so that a record of the information can be saved by copying the web address and saving it in a bookmark folder on your Internet browser. Consult Appendix G for further help on individual entries into the QRA online form. The required fields and formats for the input values on the QRA form are listed below.

- Length of hazard zone (positive number)
- Average travel speed (positive number)
- Recurrence interval (positive number)
- Probability of an unstable slope event not triggered by an earthquake (number between 0 and 1)
- Probability of an unstable slope event triggered by an earthquake (number between 0 and 1)
- Boulder size (positive number)
- Vulnerability of death or injury (number between 0 and 1)
- Number of People visiting the hazard zone per year (positive number)

## Account

The account page allows users to change their password by entering it twice and clicking Change Password. An administrator may additionally add new users by setting their ID and password. The administrator can also change the permission level for new and existing users. The administrator can click on Show Users link to see a list of all users and their permissions. Next to each user is a dropdown with their permission level. Click Change to confirm. Finally, the administrator may remove a user by clicking the Delete user link next to a user in the list.

## Logout

The Logout link in the top taskbar logs out the current user from the site.

## DATABASE SEARCHING AND REPORTING FUNCTIONALITY

### Conducting a Search of the Database

To perform a database search, first navigate to the Map page on the USMP website. Select the type of information you want to search from the drop down in the upper left of the page. Three new dropdown lists will open: Slope Rating Information Search, New Slope Event Information Search, and Maintenance Information Search. First, select the information area to narrow your search criteria. Under each of these three information areas, three additional drop downs will be available to further refine your search from the available fields within the database.

When the “Search on Map” button is clicked, the data was incorrectly formatted when entered in the search so an error message will be displayed, as shown in Figure 8. If the input criteria are formatted correctly and the database contains one or more sites that satisfy the entered search criteria, those sites will be graphically displayed on the Map page.

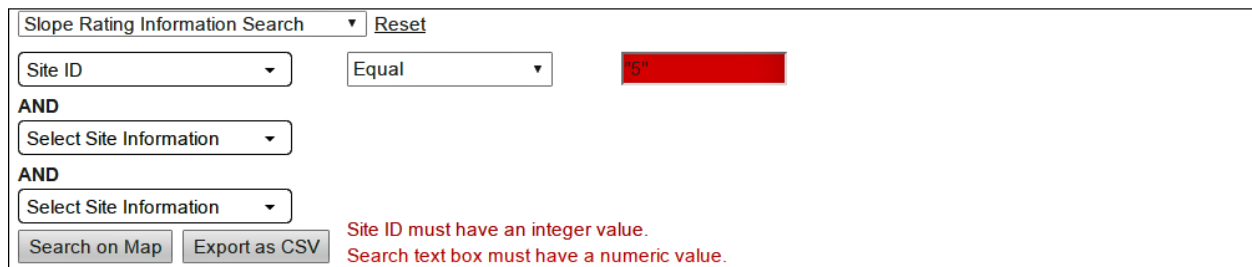

The screenshot shows a search interface for 'Slope Rating Information Search'. It includes a 'Reset' link, a 'Site ID' dropdown menu, an 'Equal' operator dropdown, and a search text box containing '15'. Below these are two 'AND' sections, each with a 'Select Site Information' dropdown. At the bottom are 'Search on Map' and 'Export as CSV' buttons. A red error message is displayed: 'Site ID must have an integer value. Search text box must have a numeric value.'

**Figure8. Example error message for incorrect search criteria.**

Further information on a particular site can be viewed by clicking on any of the icons displayed on the map and opening a pop-up window. New searches are possible by returning the search boxes back to the default settings by clicking on the reset link under the navigation bar.

When searching and reporting tool, note that it is good practice to check the “Latest edit only” box so only the latest unstable slope rating form edits for each site are searched and reported. Leaving the checkbox unchecked could result in multiple slope rating forms for a single site being reported during the search. This is a helpful search method when looking at maintenance and new slope event forms, but not for the slope rating form searches.

## **Exporting search results**

To export search results into a comma-delimited file, click on the “Export as CSV” button once a search is complete. Search results will be saved as a .CSV file containing all the information from the database for the sites meeting the search criteria.

## **FINDING AND USING THE USMP IOS/ANDROID MOBILE APPLICATIONS**

The Slope Rating, New Slope Event, and Maintenance Forms were packaged in an application for hand-held devices that would allow for quick entry of field information and upload of photos to a stable iOS or Android device. When out of the range of Internet service, the applications will also save information in an offline condition. Temporarily stored information can be uploaded (one at a time) from the application(s) to the website once Internet service is available.

In order to download these applications to your preferred hand-held field devices, search for “USMP” on the Google Play store, or the Apple App store, depending on the type of your mobile device. Install the mobile application by clicking Install.

### **Starting the Mobile Application**

Click on the “USMP” icon to start the app.

### **Beginning a New Form**

To access the three rating forms, press on the toolbar on the top left hand corner to open the main menu (see Figure 9). Select the desired form from the menu. Once open, the form can be filled out similarly to the USMP website. If using the “Get Coordinate Button” in the App for the forms, be sure to stay in the beginning and ending location long enough that when you press the “Get Coordinate” button it shows the same results at least two times in a row. The satellite geometry will take some time to coordinate your location and patience during this data field collection can save a lot of time later. Even though the applications have a geographic coordinate button, it is recommended that a secondary device to double-check the coordinates be used. Location data needs to be accurate to be useful. In addition, make sure to click out of the last entry field for the calculations to update the forms properly. The form automatically saves the information as the user fills in information. The same required fields are used in the application. Please refer to the earlier sections of this appendix for the required fields for these three forms.

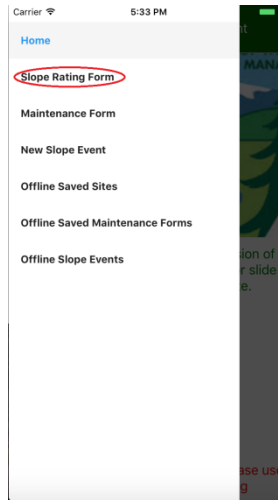

**Figure 9. Main menu for mobile application.**

### **Viewing and Editing Saved Sites**

To view or edit a saved site, select “Offline Saved Sites” on the main menu in the upper left-hand corner of the screen. A list of saved sites will appear, as shown in Figure 10. Tap on the ‘Edit’ button of the desired site to open the site’s slope rating form. Make the necessary edits to the form and go back to the home screen and the form will automatically save the changes. A rated site with information can be deleted if you select the “Delete” button. This feature should be used carefully and with proper intent.

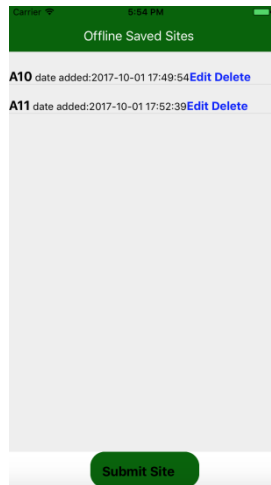
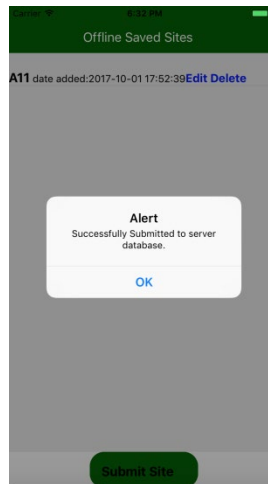

**Figure10. Example of offline saved sites.**

### **Transmitting Saved Information from Mobile Apps to the USMP Database:**

Once connected to the Internet, select the Offline Saved Sites option in the main menu. Tap on one site at a time and click on the “Submit Site” button for submission to the database. A message will automatically be generated indicating the success of the transfer, and the saved information will automatically be removed from the offline database associated with the mobile

app (see Figure 11). Note that the successful transmission message may take up to 10 seconds or more to generate following the upload. If impatient, and the uploader attempted to upload the site several times before the successful transmission message appears, multiple duplicative uploads will occur and the USMP website will not let you edit the site until you delete the submitted duplicates for that site. Please note that while the research and development team recognize that the application is not perfect and has some limitations, the goal for the investment was primarily directed to functionality and improving the efficiency of field-going and maintenance personnel in limiting redundant work efforts to collect much needed data for the unstable slope assets to be managed.



**Figure11. Example message indicating successful data transfer from mobile app to USMP online database.**

## **APPENDIX D. BENEFIT/COST APPROACH FOR ROCK AND SOIL SLOPES**

This document presents a series of alternative approaches for benefit/cost prioritization of slope preservation, mitigation, and reconstruction for roads and trails. All the approaches are based on roadway examples utilizing widely-accepted principles of risk management and asset management, with varying levels of data requirements. The approaches are meant to provide an objective and consistent means of summarizing the degree to which each project may contribute to agency objectives while minimizing long-term cost and risk.

### **INTRODUCTION**

Transportation Asset Management (TAM) is a strategic and systematic process of maintaining and managing infrastructure assets throughout their life cycle, focusing on business and engineering practices for resource allocation and utilization. It uses data and analysis to improve decision making, with the objective of providing the required level of service in the most cost-effective manner (Gordon et al 2011).

For certain major asset classes such as pavements and bridges, the techniques of TAM are codified in law (23 USC 119, FHWA 2015) and in various standards documents (Thompson and Hyman 1992, GASB 1999, Cambridge et al 2002, NAMS 2006, BSI 2008, Gordon et al 2011). Mature data collection processes are in place for these asset classes, with relatively advanced models and information systems (Cambridge 2003, Hawk 2003, Sobanjo and Thompson 2011 and 2013).

Federal laws and regulations encourage agencies to apply asset management principles to all physical assets within the right-of-way corridor. State and Federal agencies have begun to specifically recognize the importance of geotechnical assets to corridor performance. (Anderson and Rivers 2013, Anderson, et al. 2014). State DOTs such as Alaska, Washington, Oregon, and Colorado are starting to do this for rock and soil slopes, and other geotechnical assets (WSDOT 2010, ODOT 2011, Thompson et al 2014.)

For agencies and asset classes that lack a history of data collection and lack sophisticated tools, the appropriate methods for geotechnical assets are much simpler than those that are commonly used for pavements and bridges. Nonetheless, the adoption of certain basic well-structured practices, relying on a systematic inventory and condition survey, can substantially enhance the consistency and objectivity of priority setting and resource allocation. This can reduce long-term costs and establish the groundwork for continuous improvement over time.

### **Purpose**

TAM is generally understood as a medium-range process for planning investments to preserve and enhance the ability of existing physical assets to contribute to agency objectives. Typically the planning of preservation and risk mitigation projects looks ahead for up to four or five years, and the strategic planning of investment funding requirements may look ahead for 10 years or more.



For the 10-year timeframe of investment analysis, it is common to forecast the development of new needs, resulting from normal deterioration or extreme events, using probabilistic models. This can be analyzed quantitatively for each asset, but is summarized at the network level, without identifying specific assets, for reporting of results.

Benefit/cost analysis is the fundamental framework for setting priorities and allocating resources in asset management. In TAM practice, the benefit of a project may include the delay or avoidance of costs, the reduction of risk (either the likelihood of an adverse event or service disruption, or the consequence, or both), or other contributions to transportation objectives such as safety, mobility, or environmental and cultural resource sustainability.

The need for prioritization and resource allocation arises because of limitations on funding. The list of attractive projects that need to be completed is always more costly than can be accomplished with available funds. If two projects are expected to have the same benefit, then in principle the one with lower cost is given more priority. If two projects have the same cost, the one with higher benefit is given more priority. A list of projects sorted by benefit/cost ratio provides a consistent way to determine the maximum benefit that is achievable for any given amount of funding, and selects the list of projects that can achieve this high level of benefits.

If these concepts of benefit and cost can be quantified in a useful way, then the agency is provided with a tool that is relatively simple to use for:

- Priority setting: deciding which projects should be funded within a specific timeframe given limited resources.
- Resource allocation: deciding how much funding should be allocated to different parts of the asset inventory at different times.
- Level of service standards: deciding what levels of condition or resilience should be considered acceptable or unacceptable for any given asset, thus determining which assets need risk reduction corrective action.
- Performance targets: deciding what network-wide conditions can be achieved over a long timeframe if a given funding level is provided and consistent asset management practices are implemented.

To support these management functions, the challenge then is to define a reasonable and useful way of quantifying benefits and costs.

### **Basic Principles**

It is understood that quantitative asset management will be a relatively new capability for Federal Land Management Agency (FLMA) unstable slopes. Gathering of inventory and condition data has only recently begun on pilot corridors. In this context, a key goal is to find a relatively simple way to quantify benefits and costs, which can be developed using the data anticipated to become available, and which gives a fair representation of agency objectives and costs over time considering the major variables that distinguish one project from another in the asset inventory.

This would be used as a decision support tool, providing information to be weighed by decision makers along with non-quantitative considerations and other high priority facility demands within a given FLMA jurisdiction. The product should be:

- Consistent with agency mission and objectives, as typically defined in the mission statement or strategic plan. This can vary from one agency to another. Ideally all agency objectives that are affected by unstable slope preservation and mitigation projects should be reflected in some way in the measurement of benefits.
- Objective and consistent across the inventory, across inspectors, and over time. To the extent possible, the methodology should minimize subjectivity in the determination of project benefits. Where the application of judgment is unavoidable in determining benefits, it should be applied by professionals experienced in assessing geotechnical issues and made consistent using documentation, training, and analysis methods that are applied in the same way for every asset.
- Based on reliable data to the extent possible. The methods should require field data that would be economical to obtain in a relatively quick visual inspection process. Where possible, existing agency systems and processes should be leveraged to obtain needed data.
- Based on sound engineering and economic reasoning. The concepts that feed into benefit and cost calculations should follow generally-accepted engineering and economic principles that are stable over time. This will help to ensure long-term compatibility of the methods across asset classes in an agency-wide decision-making process.
- Tolerant of missing or estimated data. It should be possible to substitute estimated data or a simpler method in cases where essential data are missing, so all assets in the inventory can be addressed. The method can be used as a way of prioritizing the gathering of supplementary data where needed.
- Able to be improved over time with research, development, and better data. Substantial improvements in the state of the practice are routine in all branches of asset management. The FLMAs should be able to take advantage of these with a smooth transition by adopting more accurate or useful methods for computing benefits and costs as these are developed.

These tools will be used by a range of practitioners that may include planning, maintenance, and management personnel who are not necessarily engineering geologists or geotechnical engineers and who may be non-technical in their orientation. Although geological and engineering reasoning and experience may be required in making certain assessments, the benefit/cost analysis should reduce these considerations into a form that is more broadly understandable for effective usage and communication.

## **Objectives and Tradeoffs**

Transportation agencies typically list their major goals and objectives in their enabling legislation, mission statements, strategic plans, or other broad policy documents that communicate with stakeholders and the public.

### ***National Goals***

For transportation asset management in general, a set of national goals have been defined by the Congress in 23 USC 150(b):

*(1) SAFETY.—To achieve a significant reduction in traffic fatalities and serious injuries on all public roads.*

*(2) INFRASTRUCTURE CONDITION.—To maintain the highway infrastructure asset system in a state of good repair.*

*(3) CONGESTION REDUCTION.—To achieve a significant reduction in congestion on the National Highway System.*

*(4) SYSTEM RELIABILITY.—To improve the efficiency of the surface transportation system.*

*(5) FREIGHT MOVEMENT AND ECONOMIC VITALITY.—To improve the national freight network, strengthen the ability of rural communities to access national and international trade markets, and support regional economic development.*

*(6) ENVIRONMENTAL SUSTAINABILITY.—To enhance the performance of the transportation system while protecting and enhancing the natural environment.*

*(7) REDUCED PROJECT DELIVERY DELAYS.—To reduce project costs, promote jobs and the economy, and expedite the movement of people and goods by accelerating project completion through eliminating delays in the project development and delivery process, including reducing regulatory burdens and improving agencies' work practices.*

Congestion reduction, system reliability, and freight movement are often considered together as “mobility.”

### ***USDA Forest Service Goals and Objectives***

As an FLMA example, the USDA Forest Service goals and objectives can be found in the document, “US Forest Service Accomplishments FY2013 Federal Lands Transportation Program.” Additional information on the Forest Service Road Maintenance Management System can be located in the Forest Service guidance document: “FSH 7709.59 - Road System Operations and Maintenance Handbook – Chapter 60 – Road Maintenance.” These goals and objectives can be summarized in the following three categories:

- Overall goals and objectives from investment strategy – maintain and preserve and if possible improve access to high priority areas.
- Specific goals and objectives:
  - Ensure safe access
  - Reduce bridge deficiencies
  - Focus on high priority roads for maintenance and improvement
- FS strategic plan goals and priorities
  - Facilitate outdoor recreation opportunities
  - Enhance social, health, economic, etc. opportunities and experiences for visitors
  - Provide seamless transportation access from public roads to NFS destinations
  - Implement forest plans
  - Improve rural economic opportunities
  - Manage transportation to protect natural resources

These strategic priorities imply transportation objectives of safety, mobility, and protection of natural resources.

### *Asset characteristics as Measurable Evidence of Objectives*

As a part of maximizing these system objectives, each asset makes its contribution by satisfying various criteria for its level of service:

- Condition (lack of material defects or performance deficiencies that occur with age and usage)
- Functionality (ability of an asset to perform the functions for which it was designed)
- Safety (ability of an asset to support itself and the road in a stable configuration)
- Resilience (asset characteristics which minimize the likelihood of service disruption)

Unstable slopes impact these performance measures primarily by means of the risk of service disruption caused by unstable slope events, whether rockfall, landslide, or debris flows. It is for this reason that the field assessment of condition, currently estimated by USMP score ratings, is expanded to include factors that affect each slope's ability to resist these hazards and minimize the likelihood of service disruption.

In exchange for the service provided by each asset, the agency incurs a cost. This includes the initial cost of constructing the asset, and the cost of ongoing work to keep the asset in service and functioning as designed. Typically, an agency will seek to minimize the life cycle cost of keeping assets performing acceptably according to level of service criteria. These criteria can vary depending on the asset's role in the overall transportation system.

### **FACTORS AFFECTING BENEFITS AND COSTS**

The design of a benefit/cost framework is based on a cause-and-effect understanding of the factors affecting the priority of typical projects. The major determinants are:

- Treatments: actions the agency may take to improve condition or resilience.
- Performance framework: accepted interpretations of long-term cost and risk that are independent of asset class.
- Causal variables: measurable asset properties affecting performance and costs.

Because of the need for simplicity and convenient usage, not all influential variables can be included in the methodology. It is necessary to set priorities and select those which are most important for subsequent use.

### **Treatments for Consideration**

It is important that the benefit/cost analysis provide enough detail to distinguish among the different treatments to be evaluated. How a given treatment is classified depends on agency standard operating procedures, especially the structure of the planning and programming process in which the benefit/cost analysis is to be used. In asset management, three general classes of treatment are considered:

- Routine maintenance: Treatments that are interval-based or condition-based, which do not require planning or programming. Typically, a crew examines a site, sees a need for maintenance work, and responds within a short time, generally within the same construction season if not the same day. Examples are cleaning of rockfall catchment ditches, maintaining drainage ditches and structures to shed surface runoff, and minor patching or sealing of cracks and spalls in pavement.
- Programmed construction: Treatments are planned a year or more in advance, and need to be programmed for long-term maintenance or capital funding. These are initiated by the routine inspection process. Examples are landslide mitigation, cut and embankment reconstruction, and slope scaling and construction of other risk reduction rockfall mitigation measures.
- Adverse event recovery: Treatments are executed on a quick-response or emergency basis due to unplanned events that interfere with transportation service. These events typically have high agency and user costs. Examples are scaling a hillside before removal of rock from a road surface, reconstruction of a slide-damaged pavement, and accident site recovery.

Routine maintenance and event recovery have no formal planning process associated with individual work orders, because they are assumed either to be too small or short-term to justify a planning effort, or require immediate work of highest priority. The costs of routine maintenance are included in the normal annual cost of ownership of each asset, and their magnitude will typically vary by condition state. Recovery costs are analyzed using a risk analysis, where the likelihood of unexpected adverse events will vary by condition. Projects which reduce this likelihood may recognize a project benefit.

Programmed construction treatments represent the decision variable to be analyzed in the benefit/cost analysis. Their costs appear in the denominator of the benefit/cost ratio. They include:

- Installation, construction, or improvement of risk reduction mitigation features such as earth retaining walls, shear key rock buttresses, rockfall barriers along the edge of the road, and/or on-slope rockfall risk reduction mitigation measures.
- Preservation activities such as full-depth pavement patches (deep patches), subgrade or slope reinforcement, rock slope scaling, or rock reinforcement (rock bolts and/or rock dowels).
- Reconstruction activities such as embankment reconstruction, slope flattening, ditch expansion through a new cut, or road realignment.

In general, the simplest way to conceptualize the benefit of a treatment is to compare it with an alternative treatment for the same asset. The alternatives to be compared should be mutually exclusive. For example, an agency might choose to patch a pavement, or reconstruct the entire embankment, but would not choose both at the same location. In most cases the base alternative represents taking no action in the program year under consideration, but instead delaying action to the following year. This “No Action” alternative is defined as having zero benefit and zero cost. All other alternatives for the asset have a cost greater than zero, and a benefit which may be more or less than zero. This way of organizing alternatives is especially appropriate in year-by-year programming applications where a slope is likely to require work eventually, so the primary decision-making concern is timing.

### **Performance framework**

A benefit/cost analysis requires a basis for quantifying the benefit of each project. This quantity does not necessarily have to be expressed in dollars, but it is important to try to be objective and consistent, to be able to combine dissimilar benefits in a meaningful way, and to provide a migration path so the benefit estimate can be improved over time with better data and research. As a result, in common TAM practice, if benefits are not expressed in dollars, they are expressed in a form that can be related to a dollar quantity in a predictable (not necessarily linear) way (Patidar et al 2010). The methods in common use for quantifying project benefits include:

- Life cycle agency cost: All of the current costs and forecast future costs of maintenance and programmed work are estimated over a long-time period of at least as long as the typical service life of the asset. Future costs are discounted to consider the agency preference to delay large costs for as long as possible. The key tradeoff considered in the analysis is the possibility that a small preservation expenditure made today, might yield a substantial delay in the need for a much larger expenditure later (Hawk 2003).
- User cost: In pavement and bridge management it is common practice to express project benefits from enhancements in safety, mobility, and sometimes sustainability in an economic form representing the public’s willingness to pay for better transportation

service. While this might seem complex, there is a large body of research on the topic, which has been simplified and standardized by AASHTO in its Red Book (AASHTO 2010).

- Risk analysis: Geotechnical assets affect transportation performance primarily by the risk that they may fail and cause disruptions in transportation service, or may incur exceptional maintenance costs to maintain service. The potential for service disruptions is always subject to the uncertainty of natural materials. Asset characteristics that reduce the likelihood of disruptions are collectively known as resilience (or its opposite, vulnerability). If a disruption does occur, its consequence may depend on roadway utilization, the availability of alternate routes, and factors affecting recovery costs (Sobanjo and Thompson 2013).

All of these are relevant perspectives, which can be combined to give a complete picture of project benefits. It is necessary, however, to simplify each perspective to work with the unstable slope inventory and assessment data that are expected to be available, and to keep the computations reasonably quick.

For example, it is assumed that FLMAs will not have the necessary tools in the near future to perform life cycle cost analysis for each project. However, the cost and benefit tradeoffs between preservation or risk mitigation and reconstruction can be estimated using typical data values, resulting in a simpler set of metrics that give preservation or risk mitigation actions a reasonable weight in priority-setting.

Similarly, the standardized user cost models in the AASHTO Red Book can be used in place of a consequence model for risk analysis. This would provide a simple and valid means of quantifying risk in terms of the agency objectives of safety, mobility, and sustainability.

The alternative methods described in the next chapter describe different ways of combining these methods and simplifications to define priority-setting formulas based on valid engineering and economic concepts, which are straight-forward for routine use by agencies which are just getting started in geotechnical asset management.

### **Expected Behavior of Key Variables**

Relatively few data items are required for a useful benefit/cost analysis at the level of detail discussed here. The formulas that are developed based on the preceding discussion should be expected to affect priorities in a predictable way. The major variables and effects are as follows:

- Maintenance Level: This classification system describes the expected usage and importance of each route. It provides a framework for establishing level of service standards under normal service and for adverse event recovery. The higher maintenance levels would be expected to have higher project benefits and higher costs, with higher priorities overall.

- Condition State: The definitions of condition states are based on ranges of USMP score. In most TAM applications, condition is purely a classification of degradation, disintegration, damage, and deformation of materials. In the current system, however, it also includes resilience factors such as drainage, stability, and movement history. Assets in Good condition typically are not considered for risk reduction corrective action. Those in Fair condition may be considered, and should recognize additional benefits if there is significant potential for life cycle cost savings.
- Size of slope: As a first approximation, life cycle cost, initial cost, and recovery cost are all proportional to the area of a rock slope, or the length of a soil slope.
- Traffic volume: Higher volume roads will have proportionately greater safety and mobility impacts from service disruption. Therefore, treatments that reduce the likelihood of adverse events have higher benefits on these roads. The importance of traffic volume tends to reduce the relative importance of slope size in the numerator (but not the denominator) of the benefit/cost ratio. In some agencies and in some road corridors, traffic volume may need to be estimated.
- Detour distance: Mobility impacts of service disruption are greater on roads with long or non-existent detour routes. As a result, long detour routes increase the benefit of risk reduction projects.

Given these considerations, a general form of the benefit/cost priority formula can be expressed as:

$$\frac{\textit{Benefit}}{\textit{Cost}} = \frac{[\textit{Life cycle agency benefit}] + [\textit{Risk reduction user benefit}]}{[\textit{Project cost}]}$$

Inserting the major causal variables, this formula becomes:

$$\frac{B}{C} = \frac{LCB(CS, Size) + SB(ML, CS, ADT) + MB(ML, CS, ADT, DL, DT) + RB(Size) + EB}{IC(CS, Size)}$$

Where:

$LCB(CS, Size)$  = Life cycle benefit is a function of condition state and slope size,

$SB(ML, CS, ADT)$  = Safety benefit is a function of maintenance level, condition state, and traffic volume,

$MB(ML, CS, ADT, DL, DT)$  = Mobility benefit is a function of maintenance level, condition, traffic, detour length, and detour time,

$RB(Size)$  = Recovery benefit is a savings in recovery cost as a function of size,

$EB$  = Environmental benefit is estimated on a site-specific basis to include damage to streams caused by rockfall or soil slope movement, and, if applicable, cultural or community impacts, and

$IC(CS, Size)$  = Best estimate of initial cost is a function of condition and size.



In each of the risk reduction factors, condition state and maintenance level affect the likelihood of transportation service disruption, while the remaining variables affect the consequence of service disruption. The next chapter develops alternative approaches for computing these metrics for unstable rock and soil slopes.

## ALTERNATIVE APPROACHES

Appendices 1 and 2 of this document derive formulas for detailed calculation of benefits and costs that incorporate life cycle cost analysis and risk analysis. Depending on data availability and desired level of detail, these calculations may be simplified in various ways. The following sections summarize the alternatives.

### Alternative #1: Computed benefits and costs

If sufficient data are available for a given slope, the most precise estimate of benefit/cost ratio would fully utilize the formulas in Appendices 1 and 2 of this document. Combining the life cycle cost and risk components, the ratio would be:

$$\frac{B}{C} = \frac{LCB + Likelihood \times Consequence}{IC}$$

$$LCB = Size \times ABen\$$$

*Likelihood is determined from Table A2 – 1*

$$Consequence = ADT \times (7.25 + DD \times (0.207 DL + 39.65 DT)) + Size \times Rec\$ + EB$$

$$IC = Size \times Cost\$$$

Where:

- Size* = For rock slopes: Slope size =  $0.65 \times \text{length along the road} \times \text{height}$   
= For soil slopes: Slope size = length along the road
- ABen\$* = Unit agency benefit of risk reduction corrective action (Table A1-3)
- ADT* = Average annual or seasonal daily traffic
- DD* = Number of days that traffic is detoured (Table A2-1)
- DL* = Detour length in miles
- DT* = Detour time in hours (detour length divided by detour speed)
- Rec\$* = Estimated unit cost to recover if a disruption occurs  
\$1/sq.ft for rock slopes, \$50/ln.ft for soil slopes  
(based on expert judgment from Alaska research)
- EB* = Environmental benefit is estimated on a site-specific basis
- Cost\$* = Typical unit cost of risk reduction corrective action (Table A2-3)

If a formal cost estimate is available, such as from a design study, the *IC* term can be replaced with the actual cost estimate. The maintenance and recovery costs used in this analysis are initial order-of-magnitude estimates that can be improved over time through research, interviews, or

data mining of existing maintenance records. Similarly, any of the other terms of the equation can be replaced with better estimates if available from analysis or judgment. The consequence factors \$7.25/daily vehicle, \$0.207/detour mile, and \$39.65/delay hour are derived from the AASHTO Red Book as discussed in Appendix 2 of Appendix D of this document.

For roads that have very low traffic volume but nevertheless have a strong need to remain open, a minimum ADT value may be assigned. Similarly, for seasonal traffic it is appropriate to use average seasonal ADT computed for the busiest months.

Data requirements for Alternative #1:

- Length of slope along the road.
- Height of slope (for rock slopes).
- Average annual or seasonal daily traffic.
- Detour length in miles.
- Detour time in hours, or detour speed in miles per hour.
- Estimate of environmental cost of slope failure, if applicable, on a site-specific basis to include damage to streams caused by rockfall or slope movement, cultural, or community impacts. Since there is no established methodology to compute this, it would generally be omitted unless a study has been done to quantify it. However, it is very important to the mission of many of the FLMA's.
- Maintenance level.
- Condition state.

Advantages of Alternative #1:

- Offers the most precise estimate of benefits and costs.
- Recognizes the life cycle benefit of preservation, which may save money in the long term.
- Uses all available data.
- Most reliable for defending programming decisions.

Disadvantage of Alternative #1:

- Requires the most data of the three alternatives

### **Alternative #2: Priority index**

If detour information is not available, but the manager can make a rough estimate from knowledge of the site, the term  $(0.207 DL + 39.65 DT)$  in Alternative #1 can be approximated using Table A2-2 to yield an estimate of the user cost of detours in dollars per vehicle. For routes where no detour route exists, a common method is to rely on marine or air fares for users who

must make the trip by an alternate mode. For leisure trips, or trips where no alternative mode is available, road users might decide not to make the trip at all if the road is closed. In this case, the social cost might be the lost revenue from businesses that lose access.

However, a further simplification can be achieved if the detour computation is omitted entirely. This would be valid if detour distances are relatively consistent from one site to another, or if drivers are relatively insensitive to detour distances. In this case, it can be recognized that mobility benefits tend to be correlated with safety benefits since both are strongly dependent on the likelihood of service disruption and traffic volume. Using median values of input data from the test data sets used in the Appendices of this document, the mobility benefit is about 1.5 times the safety benefit. In this case the formula in Alternative #1 can be simplified to:

$$\frac{B}{C} = \frac{Size \times ABen\$ + Likelihood \times (18 ADT + Size \times Rec\$ + EB)}{Size \times Cost\$}$$

Or if environmental benefit is also omitted, the expression can be simplified still further to:

$$\frac{B}{C} = \frac{ABen\$ + Likelihood \times (18 ADT / Size + Rec\$)}{Cost\$}$$

Where:

- Size* = For rock slopes: Slope size = 0.65 × length × height  
 = For soil slopes: Slope size = length
- ABen\$* = Unit agency benefit of risk reduction corrective action (Table A1-3)
- Likelihood* = Based on maintenance level and condition state (Table A2-1)
- ADT* = Average annual or seasonal daily traffic
- Rec\$* = Estimated unit cost to recover if a disruption occurs  
 \$1/sq.ft for rock slopes, \$50/ln.ft for soil slopes
- EB* = Environmental benefit is estimated on a site-specific basis
- Cost\$* = Typical unit cost of risk reduction corrective action (Table A2-3)

This latter formula might be more properly called a priority index, since it is moving away from expressing benefits and costs explicitly, and dollar values cannot be added to the numerator or denominator to reflect additional project impacts. In addition, this simpler formula is not valid if the unit cost of risk reduction corrective action is zero, or if no traffic exists on the road (for example, USFS Maintenance Level 1, where this type of analysis would not normally be used).

Data requirements for Alternative #2:

- Length of slope along the road.
- Height of slope (for rock slopes).
- Average annual or seasonal daily traffic.

- Estimate of environmental cost of slope failure, if applicable, on a site-specific basis to include damage to streams caused by rockfall or slope movement, cultural, or community impacts.
- Maintenance level.
- Condition state.

Advantages of Alternative #2:

- Simpler than computing costs and benefits.
- Moderate data requirements.
- Recognizes the life cycle benefit of preservation.

Disadvantages of Alternative #2:

- Does not account for sites with long detour routes, which may be problematic if these routes also have heavy traffic.
- Not able to consider additional information that may be known about specific sites, such as an actual cost estimate.

### **Alternative #3: USMP Score Priority Index**

Since the USMP score is already being calculated, a third alternative is to use it without any economic data. For example, the following formula captures three of the most significant variables:

$$Priority\ index = USMP\ Score \times \frac{ADT}{Size}$$

Where:

*Size* = For rock slopes: Slope size =  $0.65 \times \text{length} \times \text{height}$   
 = For soil slopes: Slope size = length

*ADT* = Average annual or seasonal daily traffic, or estimated number of trail users

Here the USMP score is a proxy for condition and the likelihood of service disruption, ADT is a proxy for consequence and user benefit, and Size is a proxy for the cost of risk reduction corrective action. This is known as a “worst-first” indicator because it does not consider life cycle costs. Therefore, this alternative is not able to assign a benefit to preservation actions. Note that this alternative is likely the most applicable for trails due to the fewer data inputs required.

For roads or trails that have very low traffic volume but nevertheless have a strong need to remain open, a minimum ADT value may be assigned. Similarly, for seasonal traffic it is

appropriate to use seasonal average ADT computed for the busiest months. Data requirements for Alternative #3:

- Length of slope along the road or trail.
- Height of slope (for rock slopes).
- Average daily traffic.
- USMP score (29 variables).

Advantage of Alternative #3:

- Smallest additional data requirements (assuming the USMP score is already being collected).
- Method most applicable for use on trails.

Disadvantages of Alternative #3:

- Cannot consider preservation actions, so it will produce more expensive programs in the long run.
- Does not account for maintenance and recovery costs.
- Does not account for sites with long detour routes, which may be problematic if these routes also have heavy traffic.
- Not able to consider additional information that may be known about specific sites, such as an actual cost estimate.
- Not compatible between asset classes.
- Unsuitable for resource allocation or computation of fiscally-constrained performance targets.
- More difficult to communicate to executives, planners, and the public outside the geotechnical area.

#### **Alternative #4: Hybrid of #1 and #2**

Alternatives #1 and #2 are mutually compatible in that they both approximate a benefit/cost ratio using the same factors for scaling. It is possible to use them together on different projects within the same priority list. This is especially useful for agencies that have only partial coverage of some of the data items in the inventory. The strategy would be to use #1 whenever possible, but fall back on #2 when necessary because of missing data.

Advantages of Alternative #4:

- Offers maximum reliability even with a partially completed database.
- Maximum soundness from an engineering and economic perspective.
- Most amenable to scenario analysis, such as considering fiscal alternatives and performance targets, because more of the inventory can be covered than in #1 alone.

- The approximate analysis using Alternative #2 can be used to prioritize additional data gathering for Alternative #1.

Disadvantage of Alternative #4:

- Similar to Alternative #2 for sites having incomplete data.

## **APPENDIX 1 TO APPENDIX D: DEVELOPMENT OF LIFE CYCLE AGENCY BENEFIT FACTORS**

A significant benefit of risk reduction corrective action on unstable slopes is a potential reduction in ongoing routine maintenance costs, and a potential delay in major reconstruction costs. Life cycle cost analysis (LCCA) is a tool to quantify the balance between the immediate cost of risk reduction corrective action and future cost savings (Hawk 2003, Thompson et al 2012).

LCCA relies on models of deterioration, cost, and effectiveness. It follows an asset through its life cycle, simulating deterioration and appropriate actions to correct or limit deterioration, using a set of decision rules to select these hypothetical future actions. Future costs are discounted to reflect the value of delaying expenditures as long as possible. The sum of these discounted costs is the total life cycle agency cost (LCAC).

Two competing treatment alternatives for a slope can be compared by computing the LCAC of each alternative. Usually one of these alternatives involves a risk reduction corrective action in the year under consideration, and the other alternative, denoted “do nothing,” postpones risk reduction corrective action until the following year or later. If the risk reduction corrective action has a lower LCAC, then the difference in LCAC results between the two alternatives is part of the project benefit.

In the course of carrying out this project, Microsoft Excel was utilized for example life cycle cost analyses for rock and soil slopes, using typical values of input parameters. Applying the calculation methods previously described proved useful to provide a reasonable benefit estimate for preservation and reconstruction activities, without requiring a separate LCCA for every site. This helps to make the final product simpler and easier to use. The input data applied to the example are as follows:

- Discount rate: The benefit (cost reduction) from delaying a cost by one year, expressed as an interest rate. The default value used in this analysis is 2.1%, which is typical in asset management applications.
- Deterioration model: Parameters governing how quickly slopes deteriorate from one condition state to the next. The default model for rock slopes has 38 years as the median time to deteriorate from Good to Fair, and 54 years to deteriorate from Fair to Poor. The default model for soil slopes has 55 years as the median time to deteriorate from Good to Fair, and 36 years to deteriorate from Fair to Poor. These are based on an analysis developed for unstable slopes in Alaska (Thompson et al., 2016).
- Cost models: Rock slopes have costs in \$/sq.ft (Table A1-1) for routine maintenance and risk reduction corrective actions in each condition state. Soil slopes have costs in \$/ln.ft (Table A1-2) for routine maintenance and risk reduction corrective actions in each condition state. These costs tend to increase as conditions worsen. The costs are based on models developed for Alaska DOT (Beckstrand and Mines, 2016). They are regarded as rough estimates suitable for network level use.

- Action effectiveness model: These are based on judgment. In Fair and Poor condition in the default model, slopes have a 20% chance of remaining in the same condition after a treatment, and an 80% chance of improving. From Poor condition, the typical major renovation projects have a 50% chance of resulting in Good condition.

**Table A1-1. Default unit cost of maintenance and risk reduction (RR) corrective action – Rock slopes**

	Costs in 2015 dollars/sq.ft by condition state		
	Good	Fair	Poor
<b>Routine maintenance</b>	0.05	0.20	1.00
<b>RR Corrective action</b>	0.00	2.00	12.00

**Table A1-2. Default unit cost of maintenance and risk reduction (RR) corrective action – Soil slopes**

	Costs in 2015 dollars per linear foot by condition state		
	Good	Fair	Poor
<b>Routine maintenance</b>	100	200	500
<b>RR Corrective action</b>	0	1500	3500

This analysis used a Markov deterioration model, which is the simplest form that is applicable to condition state data. It is widely used in bridge management systems and many other applications (Thompson et al 2012).

NCHRP Report 483 (Hawk 2003) has a thorough discussion of how discount rates are determined. In short, they are determined by agency policy, which should be consistent across all types of assets and all investments of similar lifespan. A common source of guidance is The White House Office of Management and Budget (OMB) Circular A-94<sup>2</sup>. Typically, inflation is omitted from life cycle cost analyses because this practice simplifies the computations. A riskless and inflationless cost of capital for long-lived investments may use 30-year US Treasury bonds for guidance, with a 2015 real interest rate of 1.4%<sup>3</sup>. Transportation agencies usually specify

<sup>2</sup> [http://www.whitehouse.gov/omb/circulars\\_a094/](http://www.whitehouse.gov/omb/circulars_a094/)

<sup>3</sup> [http://www.whitehouse.gov/omb/circulars\\_a094/a94\\_appx-c/](http://www.whitehouse.gov/omb/circulars_a094/a94_appx-c/)



higher discount rates than this, in the 2 to 5 percent range, because of uncertainties in long-term funding, future travel demand, and infrastructure requirements.

Using the default parameters as described here, Table A1-3 shows the estimated unit life cycle agency benefits computed. For any given project, life cycle benefits are computed from:

$$LCB(CS, Size) = Size \times ABen\$$$

Where:

- CS* = Condition state, based on ranges of USMP scores
- Size* = For rock slopes: Slope size = 0.65 × length × height  
= For soil slopes: Slope size = length
- ABen\$* = Unit agency benefit of risk reduction corrective action (Table A1-3)

The slope area formula for rock slopes was developed in research for Alaska DOT by photographic analysis of slope configurations across a large range of size, type, and geologic compositions (Beckstrand et al., 2016).

**Table A1-3. Unit benefit of risk reduction corrective action (Ben\$)**

	Benefits in 2015 dollars by condition state		
	Good	Fair	Poor
<b>Rock slopes (\$/sq.ft)</b>	0.00	0.23	0.55
<b>Soil slopes (\$/ln.ft)</b>	0.00	101.38	260.47

These models are relatively insensitive to discount rates, deterioration rates, and effectiveness. A 10% change upward or downward in any of these inputs causes less than a 5% change in the unit benefits. The benefits are linearly proportional to the unit costs that are input. This stability makes it reasonable to use the parameter values in Table A1-3 in a priority formula, within a normal range of uncertainty. For agencies that feel more resolution is needed between condition states, it is possible to interpolate using judgment.

## APPENDIX 2 TO APPENDIX D: DEVELOPMENT OF USER BENEFIT FACTORS

As discussed in the document section entitled, “Expected Behavior of Key Variables,” a generic benefit/cost formula for unstable slopes can be expressed as a function of the most influential variables using the equation:

$$\frac{B}{C} = \frac{LCB(CS, Size) + SB(ML, CS, ADT) + MB(ML, CS, ADT, DL, DT) + RB(Size) + EB}{IC(CS, Size)}$$

Where:

*LCB(CS, Size)* = Life cycle benefit is a function of condition state and slope size,  
*SB(ML, CS, ADT)* = Safety benefit is a function of maintenance level, condition state, and traffic volume,  
*MB(ML, CS, ADT, DL, DT)* = Mobility benefit is a function of maintenance level, condition, traffic, detour length, and detour time,  
*RB(Size)* = Recovery benefit is savings in recovery cost as a function of size,  
*EB* = Environmental benefit is estimated on a site-specific basis to include damage to streams caused by rockfall or slope movement, and, if applicable, cultural or community impacts, and  
*IC(CS, Size)* = Initial cost is a function of condition and size.

Life cycle benefit is discussed in Appendix 1 to Appendix D above. The remaining terms in the equation are discussed below. The manager can modify input parameters to customize the priority formula to suit the needs of different agencies.

### Safety

The safety benefit of a risk reduction corrective action is the savings in user cost that would be achieved if the action is taken this year, rather than waiting until the following year. It is therefore one year of the expected user cost caused by a deteriorated condition.

Safety user cost is based on an estimate of the number of avoidable crashes likely to be caused by a service disruption event such as rockfall or a landslide. These events can entail vehicles being struck by falling debris, vehicles striking debris that is already lying in the road, or vehicles that lose control, or are damaged due to debris avoidance or pavement damage. For this analysis, these incidents are assumed to be single-vehicle crashes. The AASHTO Red Book (AASHTO 2010) has procedures and research-based metrics that consider typical crash injury severity rates and property damage. The safety benefit is:

$$SB = Likelihood \times \frac{ADT}{Median ADT} \times Crash rate \times ACC\$$$

Where:

- Likelihood* = Probability of a service disruption event (Table A2-1)
- ADT* = Average annual or seasonal daily traffic
- Median ADT* = Median traffic volume for the population of slopes in the inventory
- Crash rate* = Fraction of disruption events that result in crashes, 10%
- ACC\$* = Average cost per crash (\$43,525 in 2015\$)

The likelihood of service disruption is derived from the table of road closure event frequency performance standards (Table 4) in the document contained in Appendix F, using the assumption of one unstable slope per five miles of road. These values are summarized in Table A2-1.

**Table A2-1. Annual frequency of service disruption events (Likelihood)**

Forest Service Maintenance level	Event probability (events/year) by condition state			Duration (days)
	Good	Fair	Poor	
1	0.00	1.00	1.00	183
2	0.00	1.00	2.50	14
3	0.15	0.30	1.00	5
4	0.10	0.15	1.00	2
5	0.02	0.04	0.15	1

The crash rate is an estimate of the average number of crashes per disruption event. Based on judgment this rate is assumed to be 10%. Since the crash rate is proportional to traffic volume, it is normalized so that the 10% corresponds to the median traffic volume in the inventory. These metrics should be adjusted to fit an agency’s actual data once a sufficient inventory has been gathered. It is appropriate to adjust this factor to account for seasonal variations in crash risk.

Average accident cost per crash is based on the AASHTO Red Book (AASHTO 2010, page 5-24). This figure is an average over all vehicle classes and accident types, assuming each accident involves only one vehicle. It is updated to 2015 dollars using the Consumer Price Index. Using all the default parameter values, safety benefit can be estimated as:

$$SB = Likelihood \times ADT \times 7.25$$

**Mobility**

Similar to the safety benefit, the mobility benefit is a one-year savings in user costs, which includes the travel time and vehicle operating cost associated with avoidable detours caused by service disruption events. Vehicle operating cost includes fuel, tires, wear-and-tear, and maintenance. Detour distance and time are the additional travel made necessary because of an adverse geotechnical event. The mobility benefit is:

$$MB = Likelihood \times ADT \times DD \times (DL \times VOC\$ + DT \times TT\$)$$

Where:

*Likelihood* = Probability of a service disruption event (Table A2-1)

*ADT* = Average annual or seasonal daily traffic

*DD* = Number of days that traffic is detoured (Table A2-1)

*DL* = Detour length in miles

*VOC*\$ = Average vehicle operating cost per mile (\$0.207 in 2015\$)

*DT* = Detour time in hours (detour length divided by detour speed)

*TT*\$ = Travel time cost per vehicle-hour (\$39.65 in 2015\$)

The duration of a service disruption is derived from the table of Average Time to Clear Incident and Reopen Road (Table 5) in the performance measures document contained in Appendix F. These values are summarized in Table A2-1.

Average vehicle operating cost can be found in the AASHTO Red Book (AASHTO 2010, page 5-10). This is based on the “large car” column and includes fuel, oil, maintenance, and tires. It is updated to 2015 dollars using the Consumer Price Index.

Travel time cost is also in the AASHTO Red Book (AASHTO 2010, page 5-4). This figure uses the average over all occupations, computed as an opportunity cost. It is updated to 2015 dollars using the Consumer Price Index. It is multiplied by average vehicle occupancy of 1.3, a value suggested in the AASHTO Red Book. On state highway networks, a common default value for detour speed is 45 miles per hour (mph) in the absence of site-specific data. For FLMAAs this may be 35 mph or lower.

In general, the travel time component of the mobility benefit equation is larger than the vehicle operating cost component. At a speed of 45 mph, the travel time unit cost of \$39.65/hour converts to \$0.881/mile, which is much greater than the vehicle operating cost of \$0.207/mile. In this example, if detour speed is unknown, and the default value of 45 mph is used and the mobility benefit reduces to:

$$MB = Likelihood \times ADT \times DD \times 1.088 \times DL$$

If detour distance and time cannot be obtained from an agency’s geographic information system or other records, it is possible to ask maintenance personnel or inspectors to estimate these quantities in the field or from their knowledge of the sites, using approximate ranges. From this information, an estimate of detour cost (Detour\$) can be derived, and used in the following mobility benefit equation:

$$MB = Likelihood \times ADT \times DD \times Detour\$$$

Reasonable range limits were identified based on an analysis of bridge sites in the Pontis database of Florida, a state with what is believed to be a representative sparse road network and high quality detour data. The ranges represent the 3<sup>rd</sup>, 5<sup>th</sup>, and 7<sup>th</sup> deciles in the data distribution, rounded to convenient values. The 5<sup>th</sup> decile is the median, a value that can be used if no other

estimate is possible. Table A2-2 shows the ranges of detour length and speed, typical values that are representative of each range, and the detour cost per vehicle Detour\$.

**Table A2-2. Default detour cost estimates (Detour\$)**

Ranges	Speed	Length Typical values	User cost of detours, 2015 dollars per vehicle		
			< 1 mile	< 5 miles	>= 5 miles
			0.6 mi	2 mi	15 mi
	< 30 mph	20 mph	1.31	4.38	32.84
	< 55 mph	45 mph	0.65	2.18	16.32
	>= 55 mph	60 mph	0.52	1.74	13.02

### Recovery Costs

The cost of recovery from an extreme event may include removal of debris from the road surface, repairs to damaged roadside features and protective systems, restoration of surface geometry, and paving. It may also include stabilization of the slope itself such as slope reconstruction, and/or installation of rock reinforcement, mesh on the slope, or rockfall barriers. The magnitude can be quite site-specific and incident-specific. For the purpose of a general benefit/cost analysis, the recovery benefit is estimated as:

$$RB = Likelihood \times Size \times Rec\$$$

Where:

*Likelihood* = Probability of a service disruption event (Table A2-1)

*Size* = For rock slopes: slope size =  $0.65 \times \text{length} \times \text{height}$

= For soil slopes: slope size = length

*Rec\$* = Estimated unit cost to recover if a disruption occurs

\$1/sq.ft for rock slopes, \$50/ln.ft for soil slopes

The rock slope area formula was developed in research for Alaska DOT by photographic analysis of typical slope configurations. Recovery costs are assumed to be proportional to the size of the slope, and are based on expert judgment from Alaska research.

### Initial Cost

If a project is under consideration for immediate implementation, the agency may already have a site-specific cost estimate. This should be used in the denominator of the benefit/cost formula if available. In the absence of this, the following cost formula may be used:

$$IC = Size \times Cost\$$$

Where:

*Size* = For rock slopes: slope size =  $0.65 \times \text{length} \times \text{height}$   
 For soil slopes: slope size = length  
*Cost*\$ = Typical unit cost of corrective action (Table A2-3)

**Table A2-3. Default unit cost of corrective action (Cost\$)**

	Costs in 2015 dollars by condition state		
	Good	Fair	Poor
<b>Rock slopes (\$/sq.ft)</b>	0	2.00	12.00
<b>Soil slopes (\$/ln.ft)</b>	0	1500	3500

The rock slope area formula was developed in research for Alaska DOT by photographic analysis of typical slope configurations.

Note that these costs and all previous costs in this appendix are expressed in 2015 dollars. They should be adjusted upward using the Consumer Price Index for user costs, and the ENR Construction Cost Index for agency costs, for accurate usage in the future if agency-specific costs have not been developed.

## REFERENCES FOR APPENDIX D

- AASHTO. 2010. User and Non-User Benefit Analysis for Highways. American Association of State Highway and Transportation Officials.  
Available at [https://bookstore.transportation.org/collection\\_detail.aspx?ID=65](https://bookstore.transportation.org/collection_detail.aspx?ID=65).
- Anderson, S. & Rivers, B. 2013. “Corridor Management – A Means to Understanding of Geotechnical Impacts on System Performance,” Transportation Research Record: Journal of the Transportation Research Board No. 2349, pp. 9-15.
- Anderson, S., Stanley, D., and Loehr, E. 2014. “Managing Geotechnical Assets to Improve Highway System Performance”, Geo-Strata, March/April 2014 issue, the Geo-Institute of the American Society of Civil Engineers, Reston, VA, pp 20-24.
- Beckstrand, D., Mines, A., Thompson, P., Benko, B., 2016, Development of Mitigation Cost Estimates for Unstable Soil and Rock Slopes Based on Slope Condition, TRB Compendium of Papers, No. 16-4286
- BSI. 2008. Asset Management Part 1: Specification for the optimized management of physical assets. British Standards Institute, Publicly Available Specification 55-1 (PAS 55-1).  
Available at <http://shop.bsigroup.com/en/ProductDetail/?pid=000000000030171836>.
- BSI. 2008. Asset Management Part 2: Guidelines for the application of PAS 55-1. British Standards Institute, Publicly Available Specification 55-2 (PAS 55-2).  
Available at <http://shop.bsigroup.com/en/ProductDetail/?pid=000000000030187096>.
- Cambridge Systematics, Inc., Parsons Brinckerhoff Quade and Douglas Inc., Roy Jorgensen Associates Inc., and Paul D. Thompson. 2002. Transportation Asset Management Guide. American Association of State Highway and Transportation Officials.  
Available at <http://downloads.transportation.org/amguide.pdf>.
- Cambridge Systematics, Inc. 2003. Pontis 4.3 Technical Manual. American Association of State Highway and Transportation Officials.
- FHWA. 2015a. Notice of Proposed Rule-Making on National Performance Management Measures. Federal Register 80:2, Pages 386-393. Federal Highway Administration. January 5, 2015.  
Available at <http://www.gpo.gov/fdsys/pkg/FR-2015-01-05/pdf/FR-2015-01-05.pdf>.
- FHWA. 2015b. Notice of Proposed Rule-Making on Transportation Asset Management Plans. Federal Register 80:34, Page 9232 and 9236. Federal Highway Administration. February 20, 2015.  
Available at <http://www.gpo.gov/fdsys/pkg/FR-2015-02-20/pdf/2015-03167.pdf>.

- GASB. 1999. Basic Financial Statements — and Management’s Discussion and Analysis — for State and Local Governments. Government Accounting Standards Board Statement 34. Available at <http://www.gasb.org>.
- Gordon, M., G.J. Smith, P.D. Thompson, H. Park, F.D. Harrison, and B. Elston. 2011. AASHTO Transportation Asset Management Guide, Volume 2: A Focus on Implementation. Prepared under NCHRP Project 08-69. American Association of State Highway and Transportation Officials. Available at [https://bookstore.transportation.org/item\\_details.aspx?id=1757](https://bookstore.transportation.org/item_details.aspx?id=1757).
- Hawk, H. 2003. Bridge Life Cycle Cost Analysis. National Cooperative Highway Research Program Report 483, Transportation Research Board of the National Academies. Available at [http://onlinepubs.trb.org/onlinepubs/nchrp/nchrp\\_rpt\\_483a.pdf](http://onlinepubs.trb.org/onlinepubs/nchrp/nchrp_rpt_483a.pdf).
- NAMS Steering Group. 2006. International Infrastructure Management Manual (IIMM). National Asset Management Steering Committee, New Zealand. Available at <http://www.nams.org.nz/digitiseshop/prod-67/2011-International-Infrastructure-Management-Manual.htm>.
- ODOT. 2011. Asset Management Strategic Plan. Oregon Department of Transportation. Available at [http://www.oregon.gov/ODOT/TD/asset\\_mgmt/docs/plans/04-amp-10-111711\\_final.pdf](http://www.oregon.gov/ODOT/TD/asset_mgmt/docs/plans/04-amp-10-111711_final.pdf).
- Patidar, V., S. Labi, K. Sinha, and P.D. Thompson. 2007. Multi-Objective Optimization for Bridge Management Systems. National Cooperative Highway Research Program Report 590, Transportation Research Board of the National Academies. Available at [http://onlinepubs.trb.org/onlinepubs/nchrp/nchrp\\_rpt\\_590.pdf](http://onlinepubs.trb.org/onlinepubs/nchrp/nchrp_rpt_590.pdf).
- Sobanjo, J.O., and P.D. Thompson. 2011. Enhancement of the FDOT’s Project Level and Network Level Bridge Management Analysis Tools: Final Report. Florida Department of Transportation Contract BDK83 977-01. Available at [http://www.dot.state.fl.us/research-center/Completed\\_Proj/Summary\\_MNT/FDOT\\_BDK83\\_977-01\\_rpt..pdf](http://www.dot.state.fl.us/research-center/Completed_Proj/Summary_MNT/FDOT_BDK83_977-01_rpt..pdf).
- Sobanjo, J.O., and P.D. Thompson. 2013. Development of Risk Models for Florida’s Bridge Management System: Final Report. Florida Department of Transportation Contract BDK83 977-11. Available at [http://www.dot.state.fl.us/research-center/Completed\\_Proj/Summary\\_MNT/FDOT-BDK83-977-11-rpt.pdf](http://www.dot.state.fl.us/research-center/Completed_Proj/Summary_MNT/FDOT-BDK83-977-11-rpt.pdf).
- Thompson, P. D., Beckstrand, D., Mines, A., Vessely, M., Stanley, D., Benko, B., 2016, Geotechnical Asset Management Plan., Transportation Research Record: Journal of the Transportation Research Board, vol. 2596, <https://doi.org/10.3141/2596-05>.



Thompson, P.D. and W.A. Hyman. 1992. AASHTO Guide for Bridge Management Systems. American Association of State Highway and Transportation Officials. Available at [https://bookstore.transportation.org/Item\\_details.aspx?id=343](https://bookstore.transportation.org/Item_details.aspx?id=343).

Thompson, P.D., K.M. Ford, M.H.R. Arman, S. Labi, K. Sinha, and A. Shirolé. 2012. Estimating Life Expectancies of Highway Assets. National Cooperative Highway Research Program Report 713, Transportation Research Board of the National Academies. Available at [http://onlinepubs.trb.org/onlinepubs/nchrp/nchrp\\_rpt\\_713v1.pdf](http://onlinepubs.trb.org/onlinepubs/nchrp/nchrp_rpt_713v1.pdf).

Thompson, P.D., L.A. Pierson, D.L. Beckstrand. 2014. “Condition Indices, Performance Measures, and Managing Performance Data for Geotechnical Asset Management: Don’t Get Buried!” *Geo-Strata* 15:2. American Society of Civil Engineers. March/April 2014, pp. 26-30. Available at <http://cedb.asce.org/cgi/WWWdisplay.cgi?318669>.

WSDOT. 2010. WSDOT’s Unstable Slope Management Program. Brochure. Available at <http://www.wsdot.wa.gov/NR/rdonlyres/7D456546-705F-4591-AC5B-7E0D87D15543/78408/UnstableSlopeFinaFolioWEBSMALL.pdf>.

## **APPENDIX E. GIFFORD PINCHOT NATIONAL FOREST COST ESTIMATION**

This appendix contains the conceptual design and cost estimation forms for the Gifford Pinchot National Forest, which were completed for this project.

**CONCEPTUAL DESIGN AND COST ESTIMATE FORM – UNSTABLE SLOPE SITE INFORMATION**

Management Area: Gifford Pinchot National Forest			Date: 6/30/15
Road/Trail No.: FS 25	<input type="checkbox"/> Trail <input checked="" type="checkbox"/> Road	Created by: DLB	
Beginning MP: 21.71	Ending MP: 21.86	Side R	Weather sunny
<b>Hazard Type</b>	Rockfall Planar   Wedge   Toppling Raveling/Undermining   Rock Avalanche Indeterminate Rock Failures   Diff. Erosion	<b>Landslide</b> Above, Below, or Across Route Translational   Rotational   Debris Flow Shallow slump   Erosional Failure	
Previous Total Rating 251	Previous Rating Agency Landslide Tech	Previous Rating Date 9/30/14	
Current Rating (if re-rated)			Photo # Range

**Problem Statement**  
 Moderate rockfall hazard with raveling volcanic breccia/tuff. Ditch is wide enough to catch most rockfall and there is not too much activity. Rockfall warning sign is present.

**Proposed Correction**  
 Concrete barrier to improve ditch effectiveness to nearly 100%

**ESTIMATING FACTORS**

Item	Unit	Amount Required	Unit Cost	Total Cost
Concrete barrier - used	LF	550	100	\$55,000.00
				\$ 0.00
				\$ 0.00
				\$ 0.00
				\$ 0.00
				\$ 0.00
				\$ 0.00
				\$ 0.00
				\$ 0.00
				\$ 0.00
				\$ 0.00
				\$ 0.00
				\$ 0.00
				\$ 0.00
<b>ESTIMATED TOTAL COST</b>				<b>\$55,000.00</b>

**CONCEPTUAL DESIGN AND COST ESTIMATE FORM – UNSTABLE SLOPE SITE INFORMATION**

Management Area: Gifford Pinchot National Forest				Date 6/29/15
Road/Trail No. FS 25		<input type="checkbox"/> Trail	Created by: CIC	
<input checked="" type="checkbox"/> Road				
Beginning MP 24.45	Ending MP 24.28	Side LT	Weather sunny	
<b>Hazard Type</b>	Rockfall Planar   Wedge   Toppling Raveling/Undermining   Rock Avalanche Indeterminate Rock Failures   Diff. Erosion	<b>Landslide</b> Above, Below, or Across Route Translational   Rotational   Debris Flow Shallow slump   Erosional Failure		
Previous Total Rating 416	Previous Rating Agency Landslide Tech	Previous Rating Date 10/1/14		
Current Rating (if re-rated)			Photo # Range	

**Problem Statement**  
 170 feet long  
 Rotational Slump  
 2:1 embankment, outer shell of rock on ends

**Proposed Correction**  
 Top Berm 30" wide width  
 Clear and Grub down 2'

**ESTIMATING FACTORS**

Item	Unit	Amount Required	Unit Cost	Total Cost
Excavation (Access/Toe ) 2' x 10 x 170	CY	350	\$15	\$5,250.00
Toe Berm Fill	CY	2800	\$15	\$42,000.00
Drainage Blanket Rock	CY	200	\$40	\$8,000.00
Geotextile	SY	800	\$2.50	\$2,000.00
				\$ 0.00
				\$ 0.00
				\$ 0.00
				\$ 0.00
				\$ 0.00
				\$ 0.00
				\$ 0.00
				\$ 0.00
				\$ 0.00
				\$ 0.00
				\$ 0.00
				\$ 0.00
<b>ESTIMATED TOTAL COST</b>				<b>\$57,250.00</b>

**CONCEPTUAL DESIGN AND COST ESTIMATE FORM – UNSTABLE SLOPE SITE INFORMATION**

Management Area: Gifford Pinchot National Forest				Date 6/30/15
Road/Trail No. FS 25		<input type="checkbox"/> Trail	Created by: DLB	
<input checked="" type="checkbox"/> Road				
Beginning MP 24.63	Ending MP 24.75	Side R	Weather Sunny	
<b>Hazard Type</b>	Rockfall Planar   Wedge   Toppling Raveling/Undermining   Rock Avalanche Indeterminate Rock Failures   Diff. Erosion	<b>Landslide</b> Above, Below, or Across Route Translational   Rotational   Debris Flow Shallow slump   Erosional Failure		
Previous Total Rating 465	Previous Rating Agency Landslide Tech	Previous Rating Date 7/22/14		
Current Rating (if re-rated)			Photo # Range	

**Problem Statement**  
 Hard rock cut slope with wide jointing. Boulders up to 6' in ditch, impact crater on the inside lane. Ditch is fair but blocks should be removed to restore functionality.

**Proposed Correction**  
 Clean ditch by busting boulders – scale and bolt rock face to stabilize select boulders/blocks.

**ESTIMATING FACTORS**

Item	Unit	Amount Required	Unit Cost	Total Cost
Clean ditch of large blocks	LS	1	10,000	\$10,000.00
Scale – light scaling 400sq ft/hr	HR	125	225	\$28,125.00
Rock bolt 140 x 10	LF	1,400	200	\$280,000.00
				\$ 0.00
				\$ 0.00
				\$ 0.00
				\$ 0.00
				\$ 0.00
				\$ 0.00
				\$ 0.00
				\$ 0.00
				\$ 0.00
				\$ 0.00
				\$ 0.00
				\$ 0.00
<b>ESTIMATED TOTAL COST</b>				<b>\$318,125.00</b>

**CONCEPTUAL DESIGN AND COST ESTIMATE FORM – UNSTABLE SLOPE SITE INFORMATION**

Management Area: Gifford Pinchot National Forest				Date 6/30/2015
Road/Trail No. FS 25		<input type="checkbox"/> Trail <input checked="" type="checkbox"/> Road	Created by: CIC	
Beginning MP 24.70		Ending MP 24.73	Side LT	Weather sunny
<b>Hazard Type</b>	Rockfall Planar   Wedge   Toppling Raveling/Undermining   Rock Avalanche Indeterminate Rock Failures   Diff. Erosion	Landslide Above, Below, or Across Route Translational   Rotational   Debris Flow Shallow slump   Erosional Failure		
Previous Total Rating 28.6		Previous Rating Agency Landslide Tech	Previous Rating Date 7/22/14	
Current Rating (if re-rated)			Photo # Range	

**Problem Statement**  
 150' Long, Outboard Lane, cracks in middle of outboard lane, boulders in fill.

**Proposed Correction**  
 Half width deep patch  
 Excavate Down 4 feet, 3-4 layer geogrid  
 Use on site material for fill

**ESTIMATING FACTORS**

Item	Unit	Amount Required	Unit Cost	Total Cost
Deep Patch	FT	150	300	\$45,000.00
Excavation (15' x 150' x 4')	CY	350	15	\$5,250.00
				\$ 0.00
				\$ 0.00
				\$ 0.00
				\$ 0.00
				\$ 0.00
				\$ 0.00
				\$ 0.00
				\$ 0.00
				\$ 0.00
				\$ 0.00
				\$ 0.00
				\$ 0.00
<b>ESTIMATED TOTAL COST</b>				<b>\$50,250.00</b>

**CONCEPTUAL DESIGN AND COST ESTIMATE FORM – UNSTABLE SLOPE SITE INFORMATION**

Management Area: Gifford Pinchot National Forest				Date 6/29/15
Road/Trail No. FS 25		<input type="checkbox"/> Trail <input checked="" type="checkbox"/> Road	Created by: DLB	
Beginning MP 25.11		Ending MP 25.28	Side R	Weather Sunny
<b>Hazard Type</b>	Rockfall Planar   Wedge   Toppling Raveling/Undermining   Rock Avalanche Indeterminate Rock Failures   Diff. Erosion	Landslide Above, Below, or Across Route Translational   Rotational   Debris Flow Shallow slump   Erosional Failure		
Previous Total Rating 354		Previous Rating Agency Landslide Tech	Previous Rating Date 10/2/14	
Current Rating (if re-rated)			Photo # Range	

**Problem Statement**  
 Raveling Case 2 type slope with a low visibility curve and ditch as narrow as 2'. An upper layer has cobbles and small boulders that are slowly eroding out. Only northern segment of cut is mitigated in this design.  
 270 slope length w/60' average height

**Proposed Correction**  
 Lay back the upper 1/3 of the slope to reduce the incidence of cobbles, and boulders, and then install draped mesh. Alternative lower cost. Higher maintenance option is to install concrete barrier with high tensile strength wire mesh fence extension on top.

**ESTIMATING FACTORS**

Item	Unit	Amount Required	Unit Cost	Total Cost
Crest excavation 250' x (42' x 6'1/2) = 1200 cy	CY	1200	20	\$24,000.00
Draped high tensile strength mesh (270 x 80' = 21,600)	SF	21,600	6	\$129,600.00
Clean up scaling	HR	40	225	\$9,000.00
				\$ 0.00
				\$ 0.00
				\$ 0.00
				\$ 0.00
				\$ 0.00
				\$ 0.00
				\$ 0.00
				\$ 0.00
				\$ 0.00
				\$ 0.00
				\$ 0.00
				\$ 0.00
<b>ESTIMATED TOTAL COST</b>			<b>\$162,600.00</b>	

**CONCEPTUAL DESIGN AND COST ESTIMATE FORM – UNSTABLE SLOPE SITE INFORMATION**

Management Area: Gifford Pinchot National Forest			Date 6/29/15
Road/Trail No. FS 25	<input type="checkbox"/> Trail <input checked="" type="checkbox"/> Road	Created by: CIC	
Beginning MP 25.15	Ending MP 25.20	Side LT	Weather sunny
<b>Hazard Type</b>	Rockfall Planar   Wedge   Toppling Raveling/Undermining   Rock Avalanche Indeterminate Rock Failures   Diff. Erosion	<b>Landslide</b> Above, Below, or Across Route Translational   Rotational   Debris Flow Shallow slump   Erosional Failure	
Previous Total Rating 492	Previous Rating Agency Landslide Tech	Previous Rating Date 10/2/14	
Current Rating (if re-rated)		Photo # Range	

**Problem Statement**  
 Over-steepened at roadway  
 At south end cracks extend into middle of NB lane  
 Upslope cut in volcanic tuff appears competent  
 30' width available at road  
 Existing lane cut slope upslope

**Proposed Correction**  
 MSE WALL Excavating to competent bedrock  
 Assume 15 – 30' Excavating, Average height 25'  
 Excavating end width 20'

**ESTIMATING FACTORS**

Item	Unit	Amount Required	Unit Cost	Total Cost
MSE Wall (25 tall x 205')	SF	5125	\$60	\$307,500.00
Guardrail	FT	300	\$20	\$6,000.00
Excavation (Include Temp Shoring)	CY	3,000	\$20	\$60,000.00
				\$ 0.00
				\$ 0.00
				\$ 0.00
				\$ 0.00
				\$ 0.00
				\$ 0.00
				\$ 0.00
				\$ 0.00
				\$ 0.00
				\$ 0.00
				\$ 0.00
<b>ESTIMATED TOTAL COST</b>				<b>\$373,500.00</b>



**CONCEPTUAL DESIGN AND COST ESTIMATE FORM – UNSTABLE SLOPE SITE INFORMATION**

<b>Management Area: Gifford Pinchot National Forest</b>				<b>Date 6/29/2015</b>	
<b>Road/Trail No. FS 25</b>			<input type="checkbox"/> Trail	<b>Created by: CIC</b>	
			<input checked="" type="checkbox"/> Road		
<b>Beginning MP 28.33</b>		<b>Ending MP 28.36</b>		<b>Side</b>	
<b>Hazard Type</b>		<b>Rockfall</b> Planar   Wedge   Toppling Raveling/Undermining   Rock Avalanche Indeterminate Rock Failures   Diff. Erosion		<b>Landslide</b> Above, Below, or Across Route Translational   Rotational   Debris Flow   Settlement Shallow slump   Erosional Failure	
<b>Previous Total Rating 336</b>			<b>Previous Rating Agency Landslide Tech</b>		<b>Previous Rating Date 10/3/14</b>
<b>Current Rating (if re-rated)</b>				<b>Photo # Range</b>	

**Problem Statement**  
 100' Long  
 Full Width Fill with 42" CMP culvert  
 Culvert distress at D/S 1/3 point  
 Roadway Settlement, 2-3" drop at north crack, 1/2"-1" drop at south crack

**Proposed Correction**  
 Move bypass material inside of curve, 100'  
 Deep Patch North Crack Area, 40' along CL, Full Width

**ESTIMATING FACTORS**

Item	Unit	Amount Required	Unit Cost	Total Cost
Unload Excavation	CY	70	\$15.00	\$1,050.00
Deep Patch	FT	40	\$600.00	\$24,000.00
				\$ 0.00
				\$ 0.00
				\$ 0.00
				\$ 0.00
				\$ 0.00
				\$ 0.00
				\$ 0.00
				\$ 0.00
				\$ 0.00
				\$ 0.00
				\$ 0.00
				\$ 0.00
<b>ESTIMATED TOTAL COST</b>				<b>\$25,050.00</b>

**CONCEPTUAL DESIGN AND COST ESTIMATE FORM – UNSTABLE SLOPE SITE INFORMATION**

Management Area: Gifford Pinchot National Forest				Date 6/29/15
Road/Trail No. FS 25		<input type="checkbox"/> Trail	Created by: DLB	
		<input checked="" type="checkbox"/> Road		
Beginning MP 28.36		Ending MP 28.42	Side Left	Weather sunny
<b>Hazard Type</b>	Rockfall Planar   Wedge   Toppling Raveling/Undermining   Rock Avalanche Indeterminate Rock Failures   Diff. Erosion	<b>Landslide</b> Above, Below, or Across Route Translational   Rotational   Debris Flow Shallow slump   Erosional Failure		
Previous Total Rating 401		Previous Rating Agency Landslide Tech	Previous Rating Date 10/3/14	
Current Rating (if re-rated)			Photo # Range	

**Problem Statement**  
 Rock cut has case 2 till/overburden slope above and blocky rock material is raveling out of upper cut and getting on the road.

**Proposed Correction**  
 Lay back the upper portion of the slope to a flatter angle and revegetate. Bring lay back portion to base of slope on north and consider pinned high tensile strength mesh as alternative. Some scaling on rocky base.

**ESTIMATING FACTORS**

Item	Unit	Amount Required	Unit Cost	Total Cost
Excavation	CY	890	20	\$17,800.00
Scaling	HR	80	225	\$18,000.00
Pinned high tensile strength mesh	SF	24,000	15	\$360,000.00
				\$ 0.00
				\$ 0.00
				\$ 0.00
				\$ 0.00
				\$ 0.00
				\$ 0.00
				\$ 0.00
				\$ 0.00
				\$ 0.00
				\$ 0.00
				\$ 0.00
<b>ESTIMATED TOTAL COST</b>				<b>\$395,800.00</b>

**CONCEPTUAL DESIGN AND COST ESTIMATE FORM – UNSTABLE SLOPE SITE INFORMATION**

Management Area: Gifford Pinchot National Forest				Date 6/25/15
Road/Trail No. FS 25		<input type="checkbox"/> Trail <input checked="" type="checkbox"/> Road	Created by: CIC	
Beginning MP 29.44		Ending MP 29.51	Side RT	Weather sunny
<b>Hazard Type</b>	Rockfall Planar   Wedge   Toppling Raveling/Undermining   Rock Avalanche Indeterminate Rock Failures   Diff. Erosion	Landslide Above, Below, or Across Route Translational   Rotational   Debris Flow Shallow slump   Erosional Failure		
Previous Total Rating 371		Previous Rating Agency LT	Previous Rating Date 7/13/14	
Current Rating (if re-rated)			Photo # Range	

**Problem Statement**  
 Gabion wall area: slope 13' V x 20' H Pullout Area Failure  
 Length 270 ft  
 1:1.25 Slope with RSS  
 No cracks in roadway  
 Ditch Debris dumped on out board slide

**Proposed Correction**  
 Deep Patch only at select locations where cracks were cracks extend into road.  
 RSS embankment

**ESTIMATING FACTORS**

Item	Unit	Amount Required	Unit Cost	Total Cost
Excavation (Unload: 750 cu yd) (RSS FND: 1200 cu yd)	CY	1,950	15.00	\$29,250.00
RSS Slope (12' tall x 260' long)	SF	3,120	45.00	\$140,400.00
Deep Patch @ Ends (110' total)	FT	110	600.00	\$66,000.00
				\$ 0.00
				\$ 0.00
				\$ 0.00
				\$ 0.00
				\$ 0.00
				\$ 0.00
				\$ 0.00
				\$ 0.00
				\$ 0.00
				\$ 0.00
				\$ 0.00
<b>ESTIMATED TOTAL COST</b>				<b>\$235,650.00</b>

**CONCEPTUAL DESIGN AND COST ESTIMATE FORM – UNSTABLE SLOPE SITE INFORMATION**

Management Area: Gifford Pinchot National Forest				Date 6/29/15
Road/Trail No. FS 90		<input type="checkbox"/> Trail <input checked="" type="checkbox"/> Road	Created by: DLB	
Beginning MP 13.26		Ending MP 13.32	Side Left	Weather sunny
<b>Hazard Type</b>	Rockfall Planar   Wedge   Toppling Raveling/Undermining   Rock Avalanche Indeterminate Rock Failures   Diff. Erosion	Landslide Above, Below, or Across Route Translational   Rotational   Debris Flow Shallow slump   Erosional Failure		
Previous Total Rating 446		Previous Rating Agency Landslide Tech	Previous Rating Date 7/24/14	
Current Rating (if re-rated)			Photo # Range none taken	

**Problem Statement:**  
 Rock blocks on west end could use bolting after scaling while raveling on east end is the main problem. Very little ditch results in nearly all rockfall reaching the road with many roadway scars and rockfall debris on the opposite side.

**Proposed Correction**  
 Scaling and draped mesh with a modest bolting program on larger blocks on west end of the slope.

**ESTIMATING FACTORS**

Item	Unit	Amount Required	Unit Cost	Total Cost
Draped high tensile strength mesh 80 x 420 long. Average height 90'	SF	34,000	6	\$204,000.00
Moderate scaling 300 Ft/hr	HR	120	225	\$27,000.00
Rock bolts on west end - spot bolts 35 x 12' each	LF	420	200	\$84,000.00
				\$ 0.00
				\$ 0.00
				\$ 0.00
				\$ 0.00
				\$ 0.00
				\$ 0.00
				\$ 0.00
				\$ 0.00
				\$ 0.00
				\$ 0.00
<b>ESTIMATED TOTAL COST</b>				<b>\$315,000.00</b>

## **APPENDIX F. UNSTABLE SLOPE PERFORMANCE MEASURES FOR FLMAS USING USMP RATINGS**

### **APPROACH**

The Forest Service manages its roadway system by utilizing five distinct Maintenance Levels, each with its own usage goals and objectives. Performance Measures (PMs) have been divided into two general categories, Condition Performance Measurement (Tables 1 through 4) and Management Performance Measures (Tables 5 and 6). The PMs described herein are specific to roadway classifications used by the Forest Service and may not apply to other Federal Land Management Agencies (FLMAs).

### **CONDITION PERFORMANCE MEASUREMENT**

Performance measurement based on condition follows and expands upon examples outlined in an FHWA Office of Transportation Performance Management factsheet describing a Notice of Proposed Rulemaking (NPRM)<sup>4</sup> for pavements and bridges. FHWA is proposing measures to assess the conditions of pavement and bridge assets with performance targets set by states or Metro Planning Organizations (MPOs) receiving Federal funding. This NPRM also proposes a minimum condition level as required by MAP-21. For pavements, the minimum condition level is no more than 5% of Interstate System lane miles in a Poor condition. For bridges, the percentage of Structurally Deficient bridges cannot exceed 10% of overall deck area throughout a state. For non-Interstate pavements, no minimum condition level was proposed with this rule. This differential status illustrates the challenge of setting performance measures for FLMAs such as the Forest Service, and minimum condition levels appropriate to the asset. FLMAs may develop policies following the example illustrated in this NRPM and propose minimum condition levels for only their road systems with the highest performance expectations.

For unstable slopes on roads and trails, the PM approach is based on condition rating and periodic re-rating of unstable slopes. For purposes of this USMP for FLMAs study, USMP total score ranges shown in Table 2 may be used as analogs for Good/Fair/Poor. As the FLMA system matures, this approach should be further refined as data is collected and geotechnical asset management systems become more common. For tracking purposes, a subcategory of “Poor” may indicate “Unpassable” when due to an unstable slope failure(s) that remains in disrepair for a prolonged period. As an initial start, the Forest Service advocates a PM of percentage of slopes rated as Fair or Better, along with a target of minimum accepted percentage of routes rated as “Unpassable” due to unstable slope issues.

The PM system allows for adjustments to goals and minimum conditions based on an existing Forest Service Maintenance Level scheme. Note that in the example presented in this appendix, only road corridors were selected for the demonstration project in the Gifford Pinchot National Forest in southwest Washington State, but this example and guidance is applicable to trail systems as well. At this early stage of program development, the goals can be applied only to

---

<sup>4</sup> <http://www.fhwa.dot.gov/tpm/rule/pmfactsheet.pdf>

those roads and trails that have had inventory and condition assessments performed. As the program matures and more inventories are completed, the Condition Performance Measures can be evaluated on a Regional Unit basis (such as Forest Service Regions 1, 2, 3, 4, 5, 6, 8, 9, and 10), and finally a Network basis, though some revisions may have to be made.

In addition to rerating slopes at regularly scheduled intervals (approximately every five years is proposed), it is important that all maintenance activity related to unstable slopes, including minor pavement patches and rockfall debris clean-ups, be tracked along with the size, scope, and repair cost/time in a format as provided in the USMP's Maintenance Tracking Form (Appendix B and C). Generalized record keeping, such as "one-week of pavement patching on FS-90 MP 25 to 30, using 5 crew, two trucks and 20 CY of AC patch" is not adequate to perform the follow up ratings and evaluations. Recording maintenance activities such as "cleaned 1.5 CY of rock off the inboard lane at site ID FS90\_MP25.44 at a cost of \$250" provides the data resolution needed to identify deteriorating conditions and eventually, more informed life-cycle cost analysis. Tracking of road closure events by individual site ID is also strongly recommended. Ideally, these items may be tracked by modifying some information gathered in an existing maintenance management system, but estimates made based on existing data will likely have to be made.

## **FHWA GOOD/FAIR/POOR CLASSIFICATION**

Recent research<sup>5</sup> and proposed regulations in the January 5, 2015 NPRM into categorizing condition assessments into Good/Fair/Poor divisions have been carried out on behalf of FHWA. This is intended to improve FHWA's ability to assess the health of the nation's roadway infrastructure and serves two primary objectives:

- Define a consistent and reliable method of assessing infrastructure health with a focus on bridges and pavements on the Interstate Highway System.
- Develop tools to provide FHWA, and State Departments of Transportation (DOT) personnel ready access to key information that will allow for a better and more complete view of infrastructure health nationally.

To meet these objectives, the research focused on the development of an approach for categorizing assets, mainly bridges and pavements at this point, as Good, Fair, or Poor, which can be used consistently across the country. Asset performance in this context is based on condition information. This research has recommended the following parameters for Good/Fair/Poor for bridges and pavements:

- **Good condition** – Bridge and pavement infrastructure that is free of significant defects, and has a condition that does not adversely affect its performance. This level of condition typically only requires preventive maintenance activities.
- **Fair condition** – Bridge and pavement infrastructure that has minor deterioration of bridge elements; or isolated surface defects or functional deficiencies on pavements. This level of condition typically could be addressed through minor rehabilitation, such as

---

<sup>5</sup> Improving FHWA's Ability to Assess Highway Infrastructure Health - Pilot Study Report, FHWA-HIF-12-049

crack sealing, patching of spalls, and corrosion mitigation on bridges; and overlays and patching of pavements that do not require full depth structural improvements.

- **Poor condition** – Bridge and pavement infrastructure that is exhibiting advanced deterioration and conditions that impact structural capacity. This level of condition typically requires structural repair, rehabilitation, reconstruction or replacement

**Table 1. Sample Condition Ranges for Site Total USMP Scores.**

	Good	Fair	Poor
<i>Preliminary Rating Score Range</i>	< 21 pts	$21 \leq \text{Score} \leq 161$	> 161
<i>Detailed Rating Score Range</i>	< 200	$200 \leq \text{Score} \leq 400$	> 400

## MANAGEMENT PERFORMANCE MEASUREMENT

Performance measures based on management are intended to track how well an agency is proactively managing and improving its unstable slope assets over time using data obtained during the slope rating procedures and tracking of maintenance records for road-closing unstable slope events, as well as mitigation and risk reduction repair projects. The occurrence of failures, patching, and road closures that are directly the result of geotechnical deficiencies should decrease over time. However, due to the sporadic nature of slope failures and close relationships to climatic events, many years could pass prior to observing a marked decrease in reactional responses and system-wide performance improvements.

The performance of unstable slope assets can be assessed using several different scales: a road-mile linear scale (0.25, 1-mile, 5-mile), a route or corridor scale (FS 99, FS90 mileposts 12 to 30), or an Administrative Unit scale (Gifford Pinchot NF or FS Region 6). For example, pavement condition indices are typically reported on a per mile basis, but recent Federal guidelines recommend condition being reported on a 0.10-mile basis while minimum condition levels are being proposed on the State or MPO Level. For illustrative purposes, the example contained in this document is appropriate for a Route-level assessment, and recommendations for minimum condition levels for unstable slopes are provided in the following tables. The process for developing PMs is contained in Figure 1 below.

**Figure 1. Flow Chart for Determining Performance Measures.**

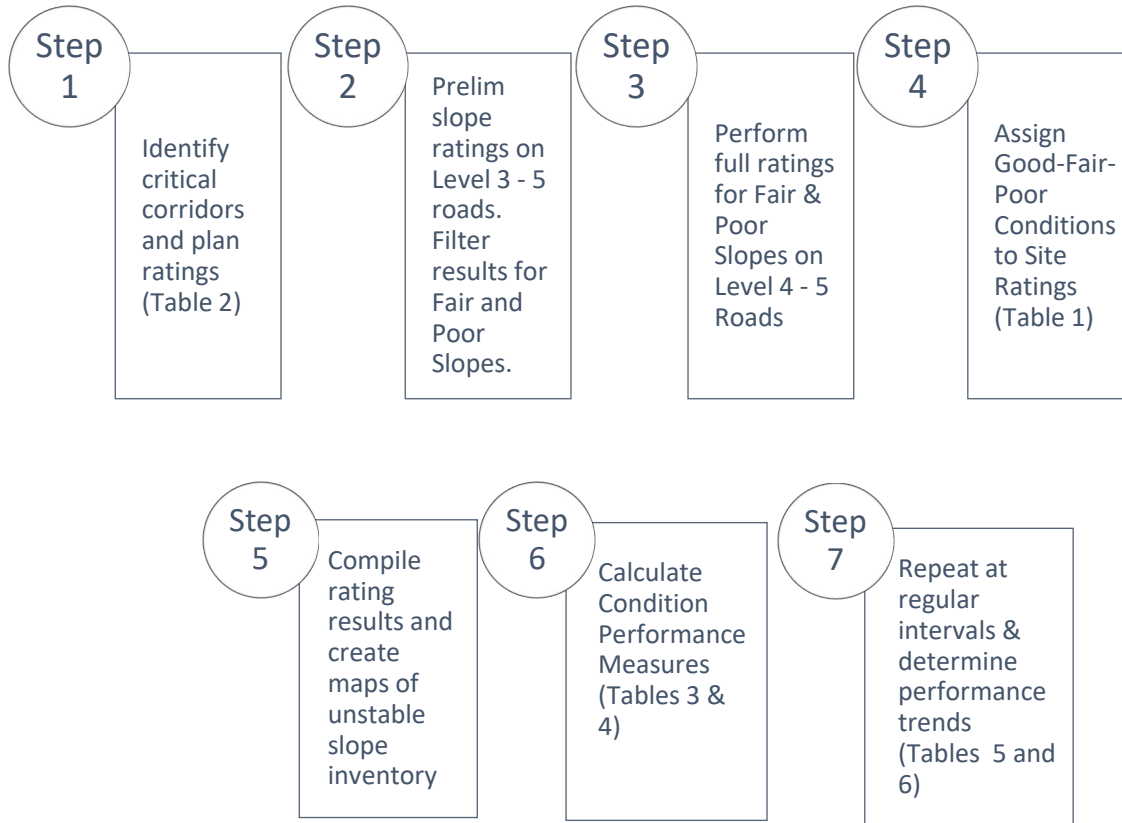



**Table 2. Unstable Slope Condition Performance Measurement Approach for Forest Service Maintenance Levels**

Forest Service Maintenance Levels (ML)	Management Approach	Assessment Approach	Assessment Planning
<p>ML-1: These are roads that have been placed in “storage”, a planned condition for more than a year that may economically be closer to 10 years, between intermittent uses. The period of storage must exceed 1 year. Basic custodial maintenance is performed to prevent damage to adjacent resources and to perpetuate the road for future resource management needs. Emphasis is normally given to maintaining drainage facilities and runoff patterns. Planned road deterioration may occur at this level. Appropriate traffic management strategies are to "prohibit" and "eliminate" all traffic. These roads are not shown on motor vehicle use maps.</p> <p>Roads receiving ML-1 may be of any type, class, or construction standard, and may be managed at any other maintenance level during the time they are open for traffic. However, while being maintained at level 1, they are not open to vehicular traffic but may be available and suitable for nonmotorized use.</p> <p><i>ROAD MANAGEMENT: No Motorized Use – Placed in storage</i></p>	<p>Slopes are maintained in a reactionary manner to minimally repair failed slopes to facilitate nonmotorized road passage, alleviate adverse drainage and runoff patterns, prevent damage to adjacent resources, and perpetuate the road for future resource management needs.</p>	<p>Judgment based, no unbiased metric available.</p>	<p>No Geotechnical Asset Management (GAM) inventory has been performed or is planned.</p>
<p>ML-2: Assigned to roads open for use by high clearance vehicles. Passenger car traffic, user comfort, and user convenience are not considerations. Warning signs and traffic control devices are not provided with the exception that some signing, such as W-18-1 “No Traffic Signs,” may be posted at intersections. Motorists should have no expectations of being alerted to potential hazards while driving these roads. Traffic is normally minor, usually consisting of one or a combination of administrative, permitted, dispersed recreation, or other specialized uses. Log haul may occur at this level. Appropriate traffic management strategies are either to: a) Discourage or prohibit passenger cars, or b) Accept or discourage high clearance vehicles.</p> <p><i>ROAD MANAGEMENT: High Clearance Vehicles, no comfort, convenience, or speed considerations in management considerations.</i></p>	<p>Slopes are maintained in a reactionary manner to sufficiently repair failed slopes to facilitate road passage by high clearance vehicles. A significant geotechnical failure may make the road ‘unpassable,’ rather than ‘closed,’ until repair activities are completed.</p>	<p>Judgment based, no unbiased metric available.</p>	<p>No GAM inventory has been performed or is planned. Reactive maintenance actions are tracked and indexed by location and cause.</p>
<p>ML-3. Assigned to roads open and maintained for travel by a prudent driver in a standard passenger car. User comfort and convenience are not considered priorities. The Manual on Uniform Traffic Control Devices (MUTCD) is applicable. Warning signs and traffic control devices are provided to alert motorists of situations that may violate expectations.</p>	<p>Slopes are maintained in a proactive and reactionary manner to rehabilitate or repair using standard</p>	<p>Percentage of slopes in Good Condition and in Poor Condition. Measured</p>	<p>Preliminary GAM inventory and condition assessment has been performed.</p>

<b>Forest Service Maintenance Levels (ML)</b>	<b>Management Approach</b>	<b>Assessment Approach</b>	<b>Assessment Planning</b>
<p>Roads in this maintenance level are typically low speed with single lanes and turnouts. Appropriate traffic management strategies are either "encourage" or "accept." "Discourage" or "prohibit" strategies may be employed for certain classes of vehicles or users.</p> <p><i>ROAD MANAGEMENT: Passable by passenger car. Reasonable expectation of predictable road conditions and warning signs.</i></p>	<p>engineering investigation and evaluation techniques and approaches.</p>	<p>every five years.</p>	<p>Reactive maintenance actions are tracked and indexed by location and cause.</p>
<p>ML-4. Assigned to roads that provide a moderate degree of user comfort and convenience at moderate travel speeds. Most roads are double lane and aggregate surfaced. However, some roads may be single lane. Some roads may be paved and/or dust abated. Manual on Uniform Traffic Control Devices is applicable. The most appropriate traffic management strategy is "encourage." However, the "prohibit" strategy may apply to specific classes of vehicles or users at certain times.</p> <p><i>ROAD MANAGEMENT: Passable by passenger car. Reasonable expectation of predictable road conditions and warning signs.</i></p>	<p>Slopes are maintained in a proactive manner to prevent failure and in a reactionary manner when needed. Rehabilitation or repair designed using standard engineering investigation and evaluation techniques and approaches.</p>	<p>Percentage of slopes in Good Condition and in Poor Condition. Measured every five years.</p>	<p>Detailed GAM inventory and condition assessment has been performed. Reactive maintenance actions are tracked and indexed by location and cause.</p>
<p>ML-5. Assigned to roads that provide a high degree of user comfort and convenience. These roads are normally double lane, paved facilities. Some may be aggregate surfaced and dust abated. Manual on Uniform Traffic Control Devices is applicable. The appropriate traffic management strategy is "encourage."</p> <p><i>ROAD MANAGEMENT: Passable by passenger car. Reasonable expectation of predictable road conditions and warning signs.</i></p>	<p>Slopes are maintained in a proactive manner to prevent failure and in a reactionary manner when needed. Rehabilitation or repair designed using standard engineering investigation and evaluation techniques and approaches.</p>	<p>Percentage of slopes in Good Condition and in Poor Condition. Measured every five years.</p>	<p>Detailed GAM inventory and condition assessment has been performed. Reactive and proactive maintenance actions are tracked and indexed by location and cause.</p>

**Table 3. Route Condition Performance Measures & Minimum Condition Levels for Unstable Slopes.**

<b>Slope Condition Performance Measures for each Maintenance Level (ML). “Fair” is the goal for Maintenance Levels 1 and 2 and “Fair” or Better for Levels 3 through 5.</b>			
Maint. Level	Good	Fair	Poor
1	Numerical evaluation not applicable. Judgment indicates few to no known slope deficiencies.	Numerical evaluation not applicable. Judgment indicates few or occasional (1 to 2 per mile) known slope deficiencies.	Numerical evaluation not applicable. Judgment indicates many (3 or more per mile) known slope deficiencies.
2	Numerical evaluation not applicable. Judgment indicates few to no known slope deficiencies and unstable slopes do not affect log haul when active.	Numerical evaluation not applicable. Judgment indicates few to no known slope deficiencies and unstable slopes slightly impacting log haul when active.	Numerical evaluation not applicable. Judgment indicates few to no known slope deficiencies and unstable slopes regularly impacting log haul when occurring.
3	<i>Minimum Condition Level for Good:</i> More than 80% of inventoried slope assets are in good condition and less than 10% of slope assets are in poor condition.	<i>Minimum Condition Level for Fair:</i> More than 70% of inventoried slope assets are in good condition and less than 15% of slope assets are in poor condition.	<i>Poor Condition Level:</i> More than 40% of inventoried slope assets are in Fair or Poor condition.
4	<i>Minimum Condition Level for Good:</i> More than 85% of inventoried slope assets are in good condition (Detailed USMP score less than 200) and less than 5% of slope assets are in poor condition (Detailed USMP score greater than 400).	<i>Minimum Condition Level for Fair:</i> More than 80% of inventoried slope assets are in good condition and less than 10% of slope assets are in poor condition. Frequency of Poor Condition Slopes are less than two per mile.	<i>Poor Condition Level:</i> More than 30% of inventoried slope assets are in Fair or Poor condition. Frequency of poor condition slopes are greater than two per mile.
5	<i>Minimum Condition Level for Good:</i> More than 95% of inventoried slope assets are in good condition and less than 2% of slope assets are in poor condition. Frequency of Poor Condition Slopes are less than one per five miles.	<i>Minimum Condition Level for Fair:</i> More than 90% of inventoried slope assets are in good condition and less than 4% of slope assets are in poor condition. Frequency of Poor Condition Slopes are less than one per mile.	<i>Poor Slope Condition:</i> More than 20% of inventoried slope assets are in Fair or Poor condition. Frequency of poor condition slopes are greater than one per mile.



**Table 4. Route-level Unstable Slope Performance Measures – Road Closing Event Frequency**

<b>Slope Performance/Road Closure Measures for each Maintenance Level (ML). “Fair” is the goal for Maintenance Levels 1 and 2 and “Fair” or better for Levels 3 through 5.</b>			
Maint. Level	Good	Fair	Poor
1	<i>Minimum Performance Level for Good:</i> Road not blocked by slope deficiencies. Few geotechnical problems exist on corridor. No deficient drainage features due to poor slope performance or condition.	<i>Corridor Unstable Slope Performance:</i> Minor rehabilitative efforts needed on slope assets to reopen as Level 2. Geotechnical problems are common. Few deficient drainage features due to poor slope performance or condition.	<i>Corridor Unstable Slope Performance:</i> Major reconstruction efforts for slope assets required to reopen as Level 2. A significant percentage of problems are geotechnical in nature. Many deficient drainage features due to poor slope performance or condition.
2	<i>Minimum Performance Level for Good:</i> Road not blocked for passage by high clearance vehicles by geotechnical deficiencies if high clearance vehicles are accepted.	<i>Corridor Unstable Slope Performance:</i> Road is commonly blocked for short periods by geotechnical deficiencies at rate of one deficiency per five miles of road.	<i>Corridor Unstable Slope Performance:</i> Road is often blocked for short periods (Table 5) by geotechnical deficiencies at rate of one deficiency per two miles of road.
3	<i>Minimum Performance Level for Good:</i> Road is open to passenger vehicles with less than one geotechnical-related closure per three-year period per ten miles.	<i>Corridor Unstable Slope Performance:</i> Road is open to passenger vehicles with geotechnical-related closures less than once per three years per five miles.	<i>Corridor Unstable Slope Performance:</i> Road is generally open to passenger vehicles, but with geotechnical-related closures occurring more than once per year per five miles of road.
4	<i>Minimum Performance Level for Good:</i> Road is open to passenger vehicles with less than one geotechnical-related closure per three-year period per fifteen miles.	<i>Corridor Unstable Slope Performance:</i> Road is open to passenger vehicles with geotechnical-related closures less than once per three years per ten miles.	<i>Corridor Unstable Slope Performance:</i> Road is open to passenger vehicles, but with geotechnical-related closures occurring once per year per five miles of road.

**Slope Performance/Road Closure Measures for each Maintenance Level (ML). “Fair” is the goal for Maintenance Levels 1 and 2 and “Fair” or better for Levels 3 through 5.**

5	<i>Minimum Performance Level for Good:</i> Road is open to passenger vehicles with less than one geotechnical-related closure per five-year period per twenty miles.	<i>Corridor Unstable Slope Performance:</i> Road is open to passenger vehicles with geotechnical-related closures less than once per five years per ten miles.	<i>Corridor Unstable Slope Performance:</i> Road is open to passenger vehicles with geotechnical-related closures less than once per three years per ten miles.
---	--	--	---

**Table 5. Management Performance Measures –Safety, Mobility, and Economic Reliability**

<b>USFS GOAL - Ensure Safety, Mobility, and Economic Reliability</b>	<b>Average time to clear incident and reopen road</b>			
Key Performance Indicator Description - Incident clearance times for slope failure related closures of points, segments or corridors for roads in an administrative unit (Region, district, forest). Relates to Table 4.	Prev. Period	Current Period	Goal	Trend
<u>ML-1</u> : Road designated as "closed." No maintenance resources expended while closed. Use may be impossible due to slope or embankment failure. Road or trail may be re-opened after failures(s) are corrected, but the work may require significant expenditure of resources. Higher priority roads may result in delays of up to six months before remediation of failures to allow safe passage.			6 Mos.	
<u>ML-2</u> : Road is "open" to high clearance vehicles, but standard vehicles may be discouraged or prohibited. Slope conditions may result in restrictions to free travel due to failures, deferred maintenance leading to impassible road lanes, or temporary unpassable sections of the entire roadway. Full or partial impasses are remediated with a relatively low priority, but should be accomplished within two weeks with safe passage restored.			2 wks	
<u>ML-3</u> : Roads open to standard passenger vehicles shall remain open with application of normal maintenance routine. Occasional, partial, or full impasses may result due to slope instability caused by deterioration and/or unusual conditions (such as heavy rainfall causing slope failures) that may require repair prioritization behind higher priority roads before safe passage can be achieved. Generally, roads are made passable within one week of significant events.			5 days	
<u>ML-4</u> : Roads usually double lane and aggregate surfaced. Some roads may be paved and some roads may be single lane. Roads provide user with a moderate degree of user comfort and convenience. Traffic is encouraged but may be prohibited at times in certain conditions or for certain vehicle types. Generally passable by passenger car. Road segment should be appropriately signed with conditions and warnings. This class of roads has moderately high priority for remaining open to travelers. Unpassable sections are rare with safe passage restored to fully blocked roads or partial blockages within two days for roads following incidents involving failing slopes or embankments.			2 days	
<u>ML-5</u> : This level is assigned highest priority for remaining open and providing safe access to destinations, and through forest lands. These roads provide a high degree of comfort and convenience to users and are normally paved two-lane roads. Some roads may be aggregate surfaced and dust-abated. Travel on these high priority roads is encouraged. These routes are expected to be passable by passenger car and should be expected to be signed appropriately with information and warning signs. Any incidents or events that result in partial or full closures shall result in prompt response and re-opening, once safe passage is ensured, within one day for roads.			1 day	
This performance measure should be reevaluated annually.				

**Table 6. Road Maintenance Prioritization**

<b>USFS GOAL – Focus on High Priority Roads for Maintenance to Prevent Impasses and Resiliency Improvement</b>				
	Prev. Period Closure Frequency & Density	Current Period Closure Frequency & Density	Performance Target	Trend
Performance Measure. Maintain slope condition to applicable good-fair-poor service levels, as measured by road closing events. Where no unstable slopes exist, the slope rating would be considered “Good.” Apply Performance Measure using "Good/Fair/Poor" ratings or frequencies from Table 4.				
<u>ML-1</u> : Road designated as "closed." Mainly reactionary maintenance resources expended while closed to mitigate drainage problems. Vehicle use may be impossible due to slope or embankment failure, but road or path may be re-opened and failures(s) corrected.			None	
<u>ML-2</u> : Road is "open" to high clearance vehicles, but standard vehicles may be discouraged or prohibited. Slope conditions may result in restrictions to free travel due to failures, deferred maintenance making road lanes impassable, or temporary closures of entire roadway.			Fair	
<u>ML-3</u> : Roads are open to standard passenger vehicles and shall remain open with application of normal maintenance routine. Occasional partial or full closures may result due to slope instability caused by deterioration and/or unusual conditions (such as heavy rainfall causing slope failures) that may require repair prioritization behind higher priority roads. Preventative maintenance is performed to reduce impacts over time.			<1 per 3 years per 10 miles	
<u>ML-4</u> : Roads are open to standard passenger vehicles and shall remain open with application of normal maintenance routine. Occasional partial or full closures may result due to slope instability caused by deterioration and/or unusual conditions (such as heavy rainfall causing slope failures) that may require repair prioritization behind higher priority roads. Preventative maintenance is performed to reduce impacts over time.			<1 per 3 years per 15 miles	
<u>ML-5</u> : Highest priority roadways. Rare partial or full closures may result due to unstable slopes. Preventative maintenance is prioritized and performed to reduce impacts over time.			<1 per 5 years per 20 miles	
This performance measure should be reevaluated every three to five years.				



**Table 7. Road Improvement Prioritization**

<b>USFS GOAL – Focus on High Priority Roads for Improvement</b>				
	Prev. Period Avg. USMP Score / Judgment	Current Avg. USMP Score / Judgment (ML 1 and 2)	USMP Score / Judgment Goal	Trend
Performance Measure – Average USMP Score per route. Maintain slope condition to applicable good-fair-poor service levels, as measured by USMP scores. Where no unstable slopes exist, the slope rating would be considered “Good.” Use USMP ratings from Steps 2 and 3.				
<u>ML-1</u> : Road designated as "closed." Mainly reactionary maintenance resources expended while closed. No improvement planned while in storage.			None	
<u>ML-2</u> : Road is "open" to high clearance vehicles, but standard vehicles may be discouraged or prohibited. Slope conditions may result in restrictions to free travel due to failures, deferred maintenance making road lanes impassable, or temporary closures (status change to ‘Storage’) of entire segment. Improvement planned only to prevent future high cost expenditures.			Fair	
<u>ML-3</u> : Roads open to standard passenger vehicles shall remain open with application of normal maintenance routine. Minor, low cost improvements planned to achieve goals over a long-term time frame.			Avg. Score (prelim) <21 Good	
<u>ML-4</u> : Roads open to standard passenger car. User comfort and convenience are not considered priorities. Improvements to offset high maintenance costs or reduce risk at high scoring sites are planned to preserve safety and mobility and reduce future maintenance needs.			Avg. Score <200, Good	
<u>ML-5</u> : Roads open and maintained for travel in a standard passenger car. Assigned to roads that provide a high degree of user comfort and convenience. These roads are normally double lane, paved facilities. Improvements are planned to offset high maintenance costs or reduce risk at high scoring sites to preserve safety and mobility and reduce future maintenance needs.			Avg. Score <175, Good	
This performance measure should be reevaluated every five years coincident with USMP re-ratings				

## APPENDIX G. QUALITATIVE RISK ANALYSIS ONLINE FORM AND USAGE

The Quantitative Risk Analysis (QRA) online form can be found by clicking QRA on the menu bar of the USMP website (shown in Figure 1). The QRA form consists of a single web page where values can be entered to estimate annualized risk from an unstable slope.



Figure 1. Online menu for USMP website.

The web form is dynamic and automatically recalculates when individual values are entered into value fields. The URL of the QRA form reflects the values entered into the various fields (example shown in Figure 2). This enables the data entered into a QRA form to be stored offline for future use by copying the URL of the form and saving it. Every time a value in the QRA form is changed, the URL will change reflecting the new value entered.

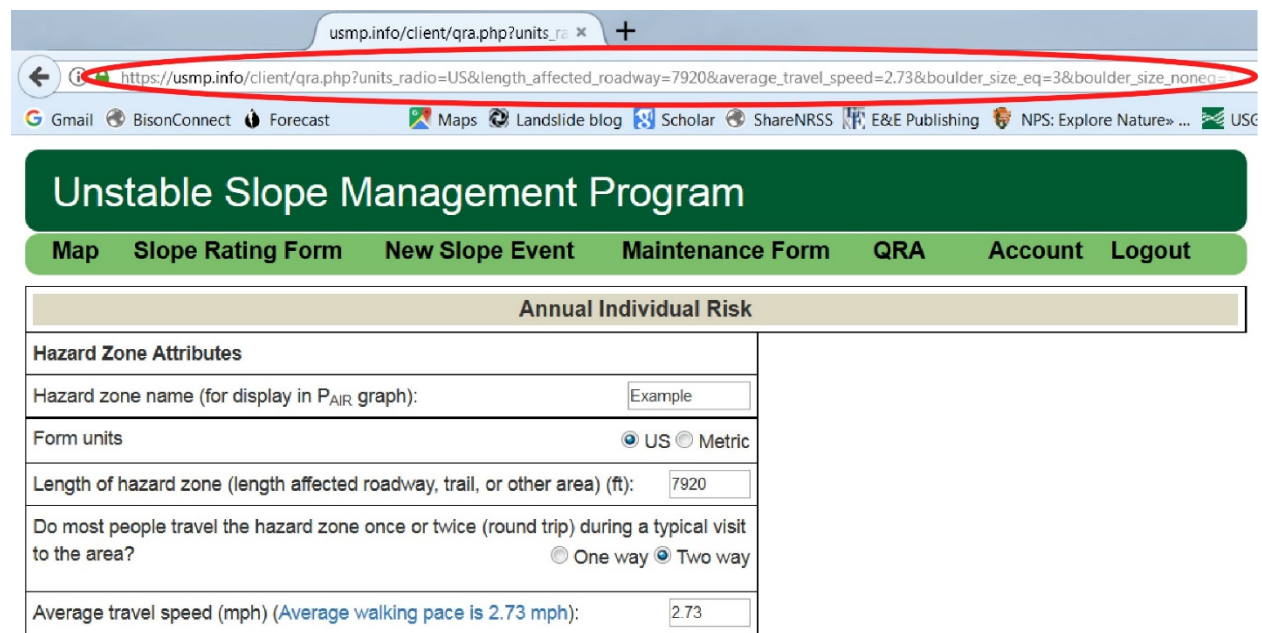

Figure 2. Screen capture of QRA website illustrating URL data capture.

### USING THE QRA FORM

The QRA form starts with attributes of the hazard zone being assessed for risk and continues with the four factors needed to estimate annual risk to a person or asset exposed to an unstable slope hazard.

## Hazard Zone Attributes

Hazard zone name (for display in  $P_{AIR}$  graph): This is the name, or identifying character string of the area that is to be assessed. This name is used in the contextual risk estimate graph shown near the bottom of the QRA webpage.

Form units: Radio buttons are provided to set the units of measure on the QRA form. Choices include U.S. customary units of feet, miles per hour, etc. or metric units of meters, kilometers per hour, etc.

Length of hazard zone (length affected roadway, trail, or other area): For roadways or trails this is the linear length of the road or trail that could be affected by the unstable slope hazard. For other assets, such as buildings, this is the length of the asset within the unstable slope zone.

Do most people travel the hazard zone once or twice (round trip) during a typical visit to the area?: Radio buttons are provided to set the travel direction(s). *One way* implies that the person would be exposed to the unstable slope hazard one time per trip, while *Two way* implies that the person would be exposed to the hazard two times per trip (round trip). This affects the occupancy time ( $P_{(pres)}$ ) factor within the risk equation.

Average travel speed: This is the average speed traveled along the transportation corridor adjacent to an unstable slope. For roads, one could use the posted or advisory speed limit or another speed based on a survey of travelers in that area. For trails, one can use the suggested average walking speed based on pedestrian road crossing research (2.73 mph, estimated by Knoblauch et al., 1996) or another speed based on a survey of travelers in that area.

## QRA Factors

The four factors of general risk equation for annual individual risk are  $P_{(occ)}$ ,  $P_{(loc)}$ ,  $P_{(pres)}$  and,  $P_{(vul)}$ .  $P_{(occ)}$  is the probability of occurrence, the annual probability of an unstable slope event affecting the hazard zone, the probability of occurrence;  $P_{(loc)}$  is the probability of a person, if present, being in the path of an unstable soil slope event in the full length of the hazard zone, or in the case of rockfall, one or more rocks at a given location, where the entire hazard zone is not necessarily affected by every event.  $P_{(pres)}$  is the occupancy rate or rate of presence, the amount of time spent by an individual in the affected area.  $P_{(vul)}$  is the vulnerability, or probability of a person being killed or injured by the event.

These four factors need to be estimated or researched for two different unstable slope triggering scenarios: 1) unstable slopes events triggered by ground motion due to earthquakes and 2) unstable slopes triggered by all other processes, as illustrated in Figure 3. The reason the form provides this option is to be able to utilize data from the United States Geological Survey (USGS) to help estimate earthquake probability. These fields use decimal numbers, not percentages. For example a 50% annual probability that an event will occur should be entered as 0.5, or an event that occurs once in 20 years would be entered as 0.05. The form automatically converts entries into scientific notation to best display low probabilities.

Probability of Occurrence ( $P_{occ}$ ) Probability of an unstable slope event being triggered by an earthquake.	Probability of an unstable slope event not triggered by an earthquake	Probability of an unstable slope event triggered by an earthquake
Recurrence interval: Number of events or event probability within <input type="text" value="1"/> years.	<input type="text" value="15"/>	<input type="text" value="0.00462407"/>
$P_{occ}$ :	<input type="text" value="1.50e+1"/>	<input type="text" value="4.62e-3"/>

Figure 3. USMP QRA form showing Probability of Occurrence ( $P_{occ}$ ).

**Probability of Occurrence ( $P_{occ}$ ).** The first factor needed to estimate risk requires data that indicate the occurrence probability or frequency of an unstable slope event. Tracking the occurrence of unstable slope events with the USMP through periodic ratings or through new slope event forms provides baseline data for this factor. In the absence of such data, scientific methods for dating unstable slope events can also be used to estimate occurrence probability. In the absence of either some basic tracking of events at a slope or scientific data on even frequency, the future probability of the unstable slope event would need to be estimated.

If small numbers of unstable slope events at a given site have been tracked over many years or large numbers of events have been tracked over several years, the recurrence probability ( $P$ ) of event  $x$  can be estimated using a simple recurrence equation,  $x$  events in  $n$  observations:

$$P(x) = x/n$$

If an event occurs and there is no, or very little, record of unstable slope events at a site, it is reasonable to assume that some slope condition changed or reached a threshold to allow for slope instability, and that this slope condition is still in effect. In this “prior” case, the period of

observation under the current slope event generating conditions is limited, but it is still conservative to assume that there is some real chance of slope events in the future. This is an assumption based on an uninformative, yet objective prior, infrequent events over a small observation period. Rather than assuming a single or small number of events in a single or small number of observation periods is informative, the prior condition mentioned above is not very informative and equal probability should not automatically be assumed for either an unstable slope event occurring or not occurring in a given observation period. So, in this “uninformative prior” case the recurrence probability (P) of event  $x$  can be estimated using a statistical formulation for events that have occurred without a strong historical record,  $x$  times in  $n$  observations:

$$P(x) = (x + 1)/(n + 2)$$

When using either the “simple” recurrence or the “uninformative prior” recurrence estimate, the estimates should be adjusted as further observations are recorded and the QRA refined.

The QRA form will automatically use the “simple” recurrence equation when a user indicates the number of years unstable slope events have been observed. For example, if five rockfall events occurred in 10 years on an unstable slope, the user would enter 10 in the “Number of events of event probability within XX years” field and then 5 in the “Probability of an unstable slope event not triggered by an earthquake” field. The user may choose to use some other formulation of annual probability based on other scientific investigations or an estimate such as the “uninformative prior” recurrence estimate discussed above. In this case, the user should enter one (1) in the “years” field and then the annual probability in decimal notation in the “Probability of an unstable slope event not triggered by an earthquake” field.

The USGS tools or mapping can be used to help determine the annual recurrence probability of an earthquake that would likely trigger an unstable slope event. As of 2017, the USGS Unified Hazard Tool can assist with this for many locations in the United States. A link to the Unified Hazard Tool is provided on the QRA form. Earthquake shaking that is described as strong, very strong, or more violent using the Modified Mercalli Intensity (MMI) (VI and greater) has caused significant slope failures during past seismic events. Using relationships between MMI and peak ground acceleration (PGA) and peak ground velocity (PGV) (Worden et al., 2012), a MMI of VI and higher translates into an unstable slope triggering PGA of 0.12-0.22 g and greater or a PGV of 9.6-20 cm/s (3.8-7.9 in./s) or greater. For example, Mackey and Quigley (2014) and Massey et al. (2014) documented that rock cliffs subjected to PGA and PGV in this range experienced rockfall. For the purposes of the QRA within the USMP, it is conservative to assume that rated unstable rockfall slopes subject to this level of shaking would likely experience some degree of slope failure. Rated unstable landslide slopes may also be susceptible to earthquake shaking induced failure but other contributing or mitigating factors such as ground water conditions should be assessed before assigning a ground motion threshold. Since precipitation is the primary trigger for debris flow susceptible unstable slopes, the QRA for these slopes can be

performed without accounting for recurrent strong ground motion unless there is good reason for doing so.

The USGS Unified Hazard Tool outputs a PGA hazard curve in terms of annual probability of exceedance for locations in the U.S. (example shown in Figure 4). For estimating the probability of occurrence ( $P_{occ}$ ) of an unstable slope event triggered by an earthquake, users should find the point on the PGA hazard curve that most closely corresponds with probable unstable slope event triggering PGA by hovering over the plotted points on the hazard curve. The annual frequency of exceedance can be entered into the field in decimal notation.

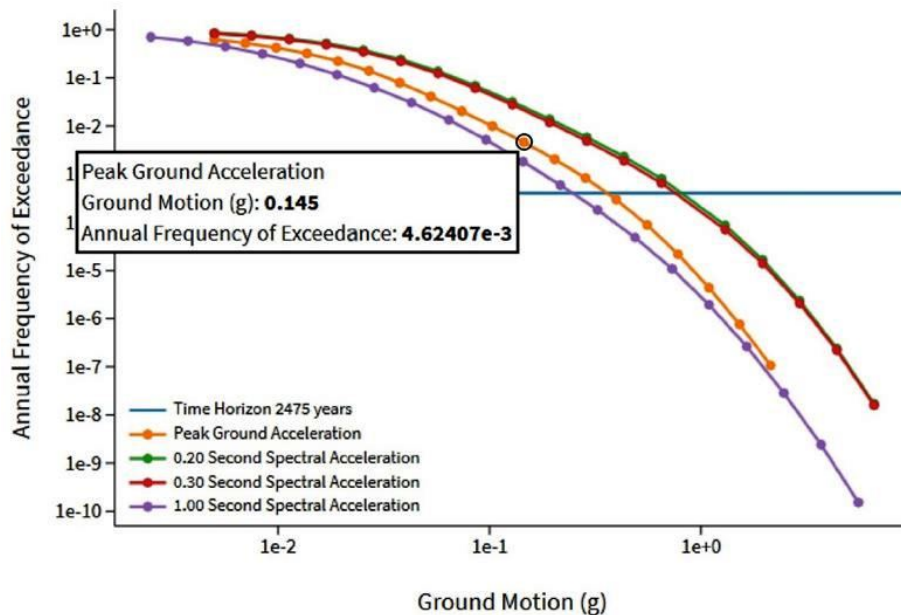

**Figure 4: USGS Unified Hazard Tool showing PGA hazard curve in terms of annual probability of exceedance for locations in the U.S.**

### **Probability of Location ( $P_{loc}$ )**

The first step to estimate the Probability of Location ( $P_{loc}$ ) is to indicate whether the risk analysis is for rockfall or landslide susceptible unstable slopes. If the most likely unstable slope event will put the entire slope into motion then, for the purposes of the QRA, it is considered a landslide; however, if the most likely unstable slope event will involve discrete blocks that will not affect the entire length of the slope (hazard zone) during an event then, for the purposes of the QRA, it is considered a rockfall. If the landslide radio button is selected (refer to Figure 5), the QRA automatically assumes that the most likely landslide affects the entire hazard zone, and the probability of a person in the hazard zone being affected by the unstable slope event is 100%. If the rockfall radio button is selected (refer to Figure 5), the QRA requires a representative boulder size to be input into the form (in feet or meters), and the likely number of boulders involved during the rockfall event to be input. As with the Probability of Occurrence ( $P_{occ}$ ), tracking unstable slope events with the USMP through updated USMP slope ratings, new slope

events, and maintenance forms provides baseline data for block size and number of individual blocks. If this data is not available, historical data about rockfall for the specific unstable slope can also be used. Other geologic factors such as discontinuity spacing, and condition could also help with this estimate.

Probability of Location ( $P_{loc}$ ) The probability of a person, if present in the hazard zone, being acted on by the unstable slope event.		Non-earthquake Trigger ( $P_{loc}$ )	Earthquake Trigger ( $P_{loc}$ )
Rockfall (manually entered probability)/Landslide (100%): <input checked="" type="radio"/> Rockfall <input type="radio"/> Landslide			
Boulder size (ft):		<input type="text"/>	<input type="text"/>
Number of boulders:		<input type="text"/>	<input type="text"/>
$P_{loc}$ :		0.00e+0	0.00e+0

**Figure 5: The probability of location section of the QRA form.**

To estimate boulder size and number of individual boulders from earthquake-triggered unstable slope rockfall events, historical events triggering rockfall on similar slopes could be used as proxies. The earthquake triggered rockfall boulder size will likely be close to the maximum block size present on the slope, dictated by discontinuity spacing. Also, many blocks of rock are likely to be dislodged at an individual rockfall susceptible slope. During an earthquake the entire slope experiences the same trigger from ground motion as opposed to other potential rockfall triggers such as frost weathering or high groundwater conditions, which may only lead to failure at certain locations along the slope. An example of the efficiency of seismic shaking to trigger rockfall events were the earthquakes in Christchurch, New Zealand in 2011. More than 650 individual blocks were dislodged from a 300 m (984 ft) long by 60 m (200 ft) tall section of highly consolidated, moderately jointed basaltic rock cliff (Mackey and Quigley, 2014). Rockfall was triggered by strong earthquakes during an aftershock sequence with a maximum magnitude of 6.2 (PGV 47.5 cm/s (18.7 in/s), PGA 2.2g). The cliff was not known to be a major source of rockfall before the earthquake sequence. Another example is from Kalepa Point in Haleakalā National Park on the Island of Maui. The basaltic rock cliffs at the point were known to shed rock on to Highway 31 throughout the year, with a history of near misses and one rockfall fatality. However, the road was rendered completely impassable due to rockfall following the 2006 magnitude 6.7 earthquake with an epicenter 87 km (54 miles) away. Based on a seismic monitoring instrument on Maui, the PGV associated with this earthquake was probably greater than 6 cm/s (2.4 in./s) and PGA was greater than 0.10g. The road was closed for two years because the route was unsafe until rockfall repair and mitigation work could be completed. In the absence of any other information, the number of rock blocks generated by strong seismic shaking can be roughly approximated as 10 times the number of blocks involved in an unstable slope event not triggered by an earthquake.

**Rockfall Probability of Location ( $P_{loc}$ )** uses the following equation to estimate the probability that a person, if present in the hazard zone, will be in the path of one rock at a given location:

$$P_{1(loc)} = (2D+d)/L$$

where  $D$  is the estimated diameter of the rock,  $d$  is the diameter of the threatened object, such as a person, and  $L$  is the length of the hazard zone threatened. The Americans with Disabilities Act minimum doorway width of 81.5 cm (32 inches) is used for the diameter ( $d$ ) when people are threatened.

During a rockfall, the probability of hitting the same location multiple times increases with the number of rocks generated by the rockfall event, such that if  $N$  rocks are randomly distributed across the slope:

$$P_{(loc)} = 1 - (1 - P_{1(loc)})^N$$

### **Probability of Occupancy ( $P_{pres}$ )**

The occupancy rate is the amount of time (measured as percent of time per year) an individual spends in the hazard zone. For transportation corridors, this is dependent on the length of the hazard zone and the speed a person travels through the hazard zone. The exposure of maintenance personnel in a transportation corridor hazard zone should also be considered. For points of interest along transportation corridors or for other areas susceptible to unstable slopes where people spend time, the number of minutes per year that an individual typically spends in the hazard zone can be estimated or determined from use surveys and entered into the form. When calculated travel time is selected, the QRA form uses the “length of hazard zone”, “one way or two way”, and “average travel speed” fields to calculate the occupancy time. If average travel speed is greater than 15 km/h (9.3 mph) then the stopping sight distance is added to the length of the hazard zone, because the ability to react to avoid a hazard is more difficult at higher speeds. Stopping sight distance is calculated based on NCHRP Report 400, Determination of Stopping Sight Distances (Fambro et al., 1997).  $P_{pres}$  is assumed to be the same for either earthquake triggered or non-earthquake triggered unstable slope events.

### **Probability of Vulnerability, $P_{(vul)}$**

Vulnerability is a consequence and must be estimated or based on previous unstable slope events. On the QRA form it is assumed that the unstable slope event has occurred and that it has impacted whatever is being assessed (structure, person, etc.). The estimated consequence could range in severity from damage to destruction of infrastructure, or injury to death for people impacted by unstable slope events. The two following empirical examples show how consequence may be estimated based on previous events.

- For landslides, the widely reported and researched landslide in Oso, Washington on March 22, 2014 killed about 74% of the people that were in its path.
- For rockfall, Grant et al. (2017) found a strong power-law correlation between modeled kinetic energy (KE) measured in kilojoules from impact on timber framed house walls and runout distance (m) into and through the structure ( $0.064KE^{0.75}$ ) and area ( $m^2$ ) directly impacted within a structure ( $0.023KE^{0.97}$ ). This work also observed that a rockfall event energy threshold may exist at approximately 10 kJ (~3.7 ft-tons). Below



about 10kJ, very small portions of each structure within the study were affected, but above 10 kJ significant consequences are possible. Based on this work, it is likely that above approximately 10 kJ (~3.7 ft-tons), rockfall striking people would likely result in a fatality.

Even with some empirical examples, judgment is likely to be required to determine a probability of fatality from rockfall or landslide scenarios because particulars can be different for different scenarios. Particulars could include the size of the probable rock striking the person and the likelihood of striking vital portions of the body. If the unstable slope event is a rockfall, and the energy of the rockfall is potentially higher during an earthquake triggered event, because of larger boulder sizes or some other factor, the probability vulnerability will be higher for the earthquake triggered event. Estimating the probability of injury or damage to a facility may involve less uncertainty as any unstable slope event that strikes a person or facility very likely causes injury or damage.

Once the values of the four factors of the QRA are input into the online form, the QRA form calculates an annual individual risk assuming that non-earthquake and earthquake triggered unstable slope events are not mutually exclusive. A quantitative risk estimate is only as accurate as the factors that go into the estimate. If most of the factors are best estimates, the QRA will be, at best, an “order of magnitude” estimate. As noted above, good event tracking or scientific studies can improve the QRA. When performing a QRA, methods of estimating the probability factors need to be transparent and clearly documented. It is also possible (and recommended) to perform two QRAs using high and low factor estimates, thus providing an estimated range of the annual individual risk. Even an “order of magnitude” risk estimate can provide good management decision information, as common annual societal risks typically span at least four orders of magnitude.

### **Comparison with Probabilities of Other Events**

The output of the QRA is presented in graphical format compared to customizable risk probabilities from other known hazards (see example in Figure 6). Up to five other risk probabilities can be manually entered to be displayed on the graph alongside the QRA result. Risk data compiled by agencies such as the National Oceanic and Atmospheric Administration (NOAA), the Centers of Disease Control and Prevention (CDC), insurance agencies, and various FLMAAs can be used in the comparative analysis. In the analysis featured in Figure 6, selected risk data sources as of 2017 were as follows:

- NOAA: <http://www.nws.noaa.gov/om/hazstats.shtml>
- CDC: <https://www.cdc.gov/nchs/nvss/deaths.htm>
- Worldwide landside: <http://blogs.agu.org/landslideblog/2017/01/30/human-cost-of-landslides-2016/>
- United States Census Bureau: <https://www.census.gov/popclock/>

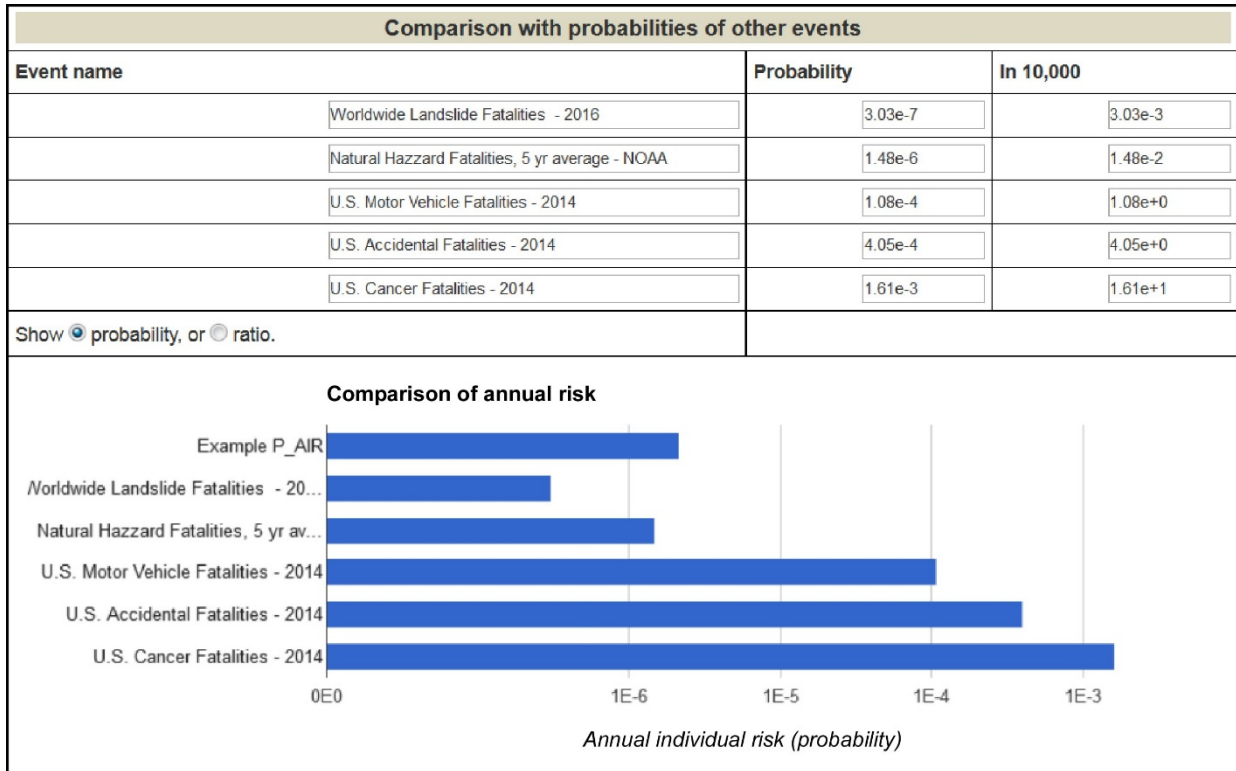

**Figure 6: Example graphical output of the QRA analysis.**

### Risk Reduction Cost/Benefit Analysis

Once the life/safety risk has been estimated, the benefit of mitigating the risk can be assigned a monetary value using the concept of a Value of a Statistical Life (VSL) for people at risk and/or the value of infrastructure at risk. VSL is the estimated cost of mitigating the risk of a fatality. The US Department of Transportation Value of a Statistical Life is about \$9.6 million in 2017 dollars (US Department of Transportation, 2013). This figure, multiplied by the estimated risk and the number of people at risk, provides an estimate for the value of mitigating the risk. Since it is not always possible to completely mitigate risk, this cost benefit analysis assumes a target natural hazard annual individual fatality risk probability of one in a million ( $1E-6$ ,  $1 \times 10^{-6}$ ). This risk level would be the goal for full mitigation or significant risk reduction and would bring the unstable slope event risk down into the range of other natural hazard risks. An example output of the analysis is shown in Figure 7.

Risk Reduction Cost/Benefit Analysis	
Only for estimates of mortality.	
Value of a Statistical Life (VSL) based on a USDOT estimate (USD):	9500000
Number of People visiting the hazard zone per year:	90000
Value an individual would assess to reduce estimated annual risk of death from the hazard to less than 1 in a Million (USD):	11
Value assessed to reduce the estimated annual risk of death from the hazard to less than 1 in a Million for all the individuals who visit the hazard zone (USD):	990000

**Figure 7: Example output of risk reduction cost/benefit analysis.**

## REFERENCES FOR APPENDIX G

- Fambro, D. B., Fitzpatrick, K., Koppa, R. J. (1997). *Determination of stopping sight distances*. National Cooperative Highway Research Program Report 400, National Academy Press, Washington D.C.
- Grant, A., Wartman, J., Massey, C. I., Olsen, M. J., O'Banion, M., & Motley, M. (2017). *The impact of rockfalls on dwellings during the 2011 Christchurch, New Zealand earthquakes*. Landslides, <https://doi.org/10.1007/s10346-017-0855-2>.
- Knoblauch, R. L., Pietrucha, M. T., & Nitzburg, M. (1996), Field studies of pedestrian walking speed and start-up time. *Transportation Research Record: Journal of the Transportation Research Board*, 1538(1), 27-38.
- Mackey, B. H., & Quigley, M. C. (2014). Strong proximal earthquakes revealed by cosmogenic <sup>3</sup>He dating of prehistoric rockfalls, Christchurch, New Zealand. *Geology*, 42(11), 975-978.
- Massey, C.I., McSaveney, M.J., Taig, T., Richards, L., Litchfield, N.J., Rhoades, D.A., McVerry, G.H., Heron, D.W., Ries, W. & Van Dissen, R.J. 2014, Determining rockfall risk in Christchurch using rockfalls triggered by the 2010–2011 Canterbury earthquake sequence, New Zealand., *Earthquake Spectra*, 30, pp. 155-181
- US Department of Transportation. (2013). *Guidance on Treatment of the Economic Value of a Statistical Life in U.S. Department of Transportation Analyses*. US Department of Transportation. Retrieved from <https://www.transportation.gov/sites/dot.dev/files/docs/VSL%20Guidance%202013.pdf>
- Worden, C. B., Gerstenberger, M. C., Rhoades, D. A., & Wald, D. J. (2012). Probabilistic relationships between ground-motion parameters and modified Mercalli intensity in California. *Bulletin of the Seismological Society of America*, 102(1), 204-221.