



U.S. Department
of Transportation
**Federal Highway
Administration**

1200 New Jersey Ave., SE
Washington, D.C. 20590

April 21, 2020

In Reply Refer To:
HSST-1/B-329

Mr. Adrian Bullock
Highway Care Ltd.
The Highlands, Detling, Maidstone, Kent
ME14 3HT
United Kingdom

Dear Mr. Bullock:

This letter is in response to your August 18, 2019 request for the Federal Highway Administration (FHWA) to review a roadside safety device, hardware, or system for eligibility for reimbursement under the Federal-aid highway program. This FHWA letter of eligibility is assigned FHWA control number B-329 and is valid until a subsequent letter is issued by FHWA that expressly references this device.

Decision

The following device is eligible within the length-of-need, with details provided in the form which is attached as an integral part of this letter:

- HighwayGuard TL-3

Scope of this Letter

To be found eligible for Federal-aid funding, new roadside safety devices should meet the crash test and evaluation criteria contained in the American Association of State Highway and Transportation Officials' (AASHTO) Manual for Assessing Safety Hardware (MASH). However, the FHWA, the Department of Transportation, and the United States Government do not regulate the manufacture of roadside safety devices. Eligibility for reimbursement under the Federal-aid highway program does not establish approval, certification or endorsement of the device for any particular purpose or use.

This letter is not a determination by the FHWA, the Department of Transportation, or the United States Government that a vehicle crash involving the device will result in any particular outcome, nor is it a guarantee of the in-service performance of this device. Proper manufacturing, installation, and maintenance are required in order for this device to function as tested.

This finding of eligibility is limited to the crashworthiness of the system and does not cover other structural features, nor conformity with the Manual on Uniform Traffic Control Devices.

Eligibility for Reimbursement

Based solely on a review of crash test results and certifications submitted by the manufacturer, and the crash test laboratory, FHWA agrees that the device described herein meets the crash test and evaluation criteria of the AASHTO's MASH. Therefore, the device is eligible for reimbursement under the Federal-aid highway program if installed under the range of tested conditions.

Name of system: HighwayGuard
Type of system: Longitudinal Barrier
Test Level: MASH Test Level 3 (TL3)
Testing conducted by: Holmes Solutions LP
Date of request: August 18, 2019

FHWA concurs with the recommendation of the accredited crash testing laboratory on the attached form

Full Description of the Eligible Device

The device and supporting documentation, including reports of the crash tests or other testing done, videos of any crash testing, and/or drawings of the device, are described in the attached form.

Notice

This eligibility letter is issued for the subject device as tested. Modifications made to the device are not covered by this letter. Any modifications to this device should be submitted to the user (i.e., state DOT) as per their requirements.

You are expected to supply potential users with sufficient information on design, installation and maintenance requirements to ensure proper performance.

You are expected to certify to potential users that the hardware furnished has the same chemistry, mechanical properties, and geometry as that submitted for review, and that it will meet the test and evaluation criteria of AASHTO's MASH.

Issuance of this letter does not convey property rights of any sort or any exclusive privilege. This letter is based on the premise that information and reports submitted by you are accurate and correct. We reserve the right to modify or revoke this letter if: (1) there are any inaccuracies in the information submitted in support of your request for this letter, (2) the qualification testing was flawed, (3) in-service performance or other information reveals safety problems, (4) the system is significantly different from the version that was crash tested, or (5) any other information indicates that the letter was issued in error or otherwise does not reflect full and complete information about the crashworthiness of the system.

Standard Provisions

- To prevent misunderstanding by others, this letter of eligibility designated as FHWA control number B-329 shall not be reproduced except in full. This letter and the test documentation upon which it is based are public information. All such letters and documentation may be reviewed upon request.
- This letter shall not be construed as authorization or consent by the FHWA to use, manufacture, or sell any patented system for which the applicant is not the patent holder.
- This FHWA eligibility letter is not an expression of any Agency view, position, or determination of validity, scope, or ownership of any intellectual property rights to a specific device or design. Further, this letter does not impute any distribution or licensing rights to the requester. This FHWA eligibility letter determination is made based solely on the crash-testing information submitted by the requester. The FHWA reserves the right to review and revoke an earlier eligibility determination after receipt of subsequent information related to crash testing.

Sincerely,

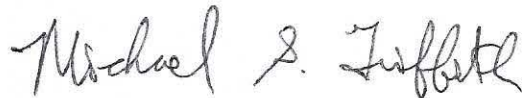

Michael S. Griffith
Director, Office of Safety Technologies
Office of Safety

Enclosures

Request for Federal Aid Reimbursement Eligibility of Highway Safety Hardware

Submitter	Date of Request:	August 18,2019	<input checked="" type="radio"/> New <input type="radio"/> Resubmission
	Name:	Adrian Bullock	
	Company:	Highway Care Ltd	
	Address:	TheHighlands, Detling, Maidstone, Kent ME143HT	
	Country:	UK	
To:	Michael S. Griffith, Director FHWA, Office of Safety Technologies		

I request the following devices be considered eligible for reimbursement under the Federal-aid highway program.

Device & Testing Criterion - Enter from right to left starting with Test Level

!-!-!

!-!-!

System Type	Submission Type	Device Name / Variant	Testing Criterion	Test Level
'B':Rigid/Semi-RigidBarriers	<input checked="" type="radio"/> Physical Crash Testing <input type="radio"/> Engineering Analysis	HighwayGuard	AASHTOMASH	TL3

By submitting this request for review and evaluation by the Federal Highway Administration, I certify that the product(s) was (were) tested in conformity with the AASHTO Manual for Assessing Safety Hardware and that the evaluation results meet the appropriate evaluation criteria in the MASH.

Individual or Organization responsible for the product:

Contact Name:	Adrian Bullock	Same as Submitter <input checked="" type="checkbox"/>
Company Name:	Highway Care Ltd	Same as Submitter <input checked="" type="checkbox"/>
Address:	TheHighlands, Detling, Maidstone, Kent ME143HT	Same as Submitter <input checked="" type="checkbox"/>
Country:	UK	Same as Submitter <input checked="" type="checkbox"/>
Enter below all disclosures of financial interests as required by the FHWA 'Federal-Aid Reimbursement Eligibility Process for Safety Hardware Devices' document.		
<p>HolmesSolutionsLP completed all of the documented testing activities under a commercial contract with HighwayCare. In accordance with the requirements of ISO 17025, all testing activities completed by Holmes Solutions LP were undertaken free from any undue commercial influence. For the completion of this testing service, HolmesSolutionsLP received payment in the form of professional fees. The fees received for the testing activities were not linked to the technical performance of the product nor the outcome of the tests. HolmesSolutionsLP does not have, nor ever had, any financial interest in HighwayCare, and has no ownership of any of the products IP. HolmesSolutionsLP does not receive any research funding (or other forms of research support) from HighwayCare.</p>		

PRODUCT DESCRIPTION

- New Hardware or Significant Modification
 Modification to Existing Hardware

HighwayGuard is a steel barrier formed from two profiled, thin gauge sheets being welded together along the join at the top, and to feet at the base, to form a long hollow section, the overall dimensions of each barrier section is 540mm wide at the base, 250mm wide at the top, 800mm high and 6,000mm long. Each longitudinal section can be connected to an adjoining section using a unique T-connector which engages with vertical pins located at the end of each section. These barrier sections are joined together and laid out along the road surface to create a longitudinal barrier system (wall). The barrier system can be installed with multiple ground anchor configurations. This barrier system incorporates ground anchors at a maximum of 60.0m between ground anchors in its standard configuration.

CRASH TESTING

By signature below, the Engineer affiliated with the testing laboratory, agrees in support of this submission that all of the critical and relevant crash tests for this device listed above were conducted to meet the MASH test criteria. The Engineer has determined that no other crash tests are necessary to determine the device meets the MASH criteria.

Engineer Name:	Emerson Ryder	
Engineer Signature:	Emerson Ryder	Digitally signed by Emerson Ryder Date: 2019.08.22 10:15:48 +12'00'
Address:	254 Montreal Street Christchurch	Same as Submitter <input type="checkbox"/>
Country:	New Zealand	Same as Submitter <input type="checkbox"/>

A brief description of each crash test and its result:

Required Test Number	Narrative Description	Evaluation Results
3-10(1100C)	<p>The longitudinal barrier successfully contained and redirected an 1100C test vehicle impacting the test article at 24.9 degrees with a velocity of 100.3 km/h. No debris or detached elements penetrated or showed potential to penetrate the occupant compartment. No fragments were distributed outside of the vehicle trajectory and therefore did not present any undue hazard to other traffic, pedestrians or work zone personnel.</p> <p>The vehicle remained upright during and after the impact and vehicle stability was considered satisfactory. Occupant risk factors satisfied the test criteria and the vehicle exit trajectory remained within acceptable limits. Dynamic Deflection was 1.41 m. Working Width was 1.80 m</p>	PASS

Required Test Number	Narrative Description	Evaluation Results
3-11 (2270P)	The longitudinal barrier successfully contained and redirected an 2270P test vehicle impacting the test article at 24.6 degrees with a velocity of 98.0 km/h. No debris or detached elements penetrated or showed potential to penetrate the occupant compartment. No fragments were distributed outside of the vehicle trajectory and therefore did not present any undue hazard to other traffic, pedestrians or work zone personnel. The vehicle remained upright during and after the impact and vehicle stability was considered satisfactory. Occupant risk factors satisfied the test criteria and the vehicle exit trajectory remained within acceptable limits. Dynamic Deflection was 1.93m. Working Width was 2.32m	
3-20 (1100C)		Non-Relevant Test, not conducted
3-21 (2270P)		Non-Relevant Test, not conducted

Full Scale Crash Testing was done in compliance with MASH by the following accredited crash test laboratory (cite the laboratory's accreditation status as noted in the crash test reports.):

Laboratory Name:	HolmesSolutionsLP	
Laboratory Signature:	Emerson Ryder	Digitally signed by Emerson Ryder Date: 2019.08.22 10:30:35 +12'00'
Address:	254 Montreal Street Christchurch	Same as Submitter <input type="checkbox"/>
Country:	New Zealand	Same as Submitter <input type="checkbox"/>
Accreditation Certificate Number and Dates of current Accreditation period :	1022 NZS ISO/IEC 17025:2005 Accreditation period valid until July 2020	

Submitter Signature*:



Submit Form







ATTACHMENTS

Attach to this form:

- 1) Additional disclosures of related financial interest as indicated above.
- 2) A copy of the full test report, video, and a Test Data Summary Sheet for each test conducted in support of this request.
- 3) A drawing or drawings of the device(s) that conform to the Task Force-13 Drawing Specifications [[Hardware Guide Drawing Standards](#)]. For proprietary products, a single isometric line drawing is usually acceptable to illustrate the product, with detailed specifications, intended use, and contact information provided on the reverse. Additional drawings (not in TF-13 format) showing details that are relevant to understanding the dimensions and performance of the device should also be submitted to facilitate our review.

FHWA Official Business Only:

Eligibility Letter		
Number	Date	Key Words

				
0.0 s	0.1 s	0.2 s	0.3 s	0.4 s
				
Test Article:	HighwayGuard		Post Impact Vehicle Behaviour	
Total Length	120.0 m		Vehicle Stability	Good
Key Elements - Barrier	MASH TL3-10		Stopping Distance	70.0 m from CIP (Remote brakes)
Description	Temporary Steel Barrier 60.0 m Anchor spacing		Vehicle Snagging	None
Length of Barrier Installation	120.0 m		Vehicle Pocketing	None
Barrier Height	800 mm		Occupant Impact Velocity	
Ground Conditions	Asphalt		Longitudinal	0.7 m/s
Test Vehicle			Lateral (optional)	5.6 m/s
Designation	1100C		Occupant Ride-down Deceleration	
Make/Model	Nissan Tiida		X-direction	-3.0 (0.2868 - 0.2968 seconds)
Dimensions (LxWxH)	4395 mm x 1695 mm x 1520 mm		Y-direction	7.4 (0.2450 - 0.2550 seconds)
Curb Wt	1094.5 kg		THIV (optional) m/s	6.0 at 0.1021 seconds on left side
Test Inertial Wt	1095.0 kg		PHD (optional) g	7.5 (0.2449 - 0.2549 seconds)
Gross Static	1170.0 kg		ASI (optional)	1.05 (0.0264 - 0.0764 seconds)
Impact Conditions			Test Article Damage	Minor
Speed	100.3 km/h		Test Article Deflections	
Angle	24.9°		Dynamic	1.41 m (4.63 ft)
Impact Point	331 mm Upstream of barrier 11		Permanent	1.30 m (4.27 ft)
Exit Conditions			Working Width	1.80 m (5.90 ft)
Exit Speed:	100 km/h estimated		Vehicle Damage Exterior	
Exit Angle:	1.8°		VDS	11LF-3
Test Number	135137.3-10		CDC	11LFEE3
Test Date	9 th May 2019		Maximum Deformation	155 MM



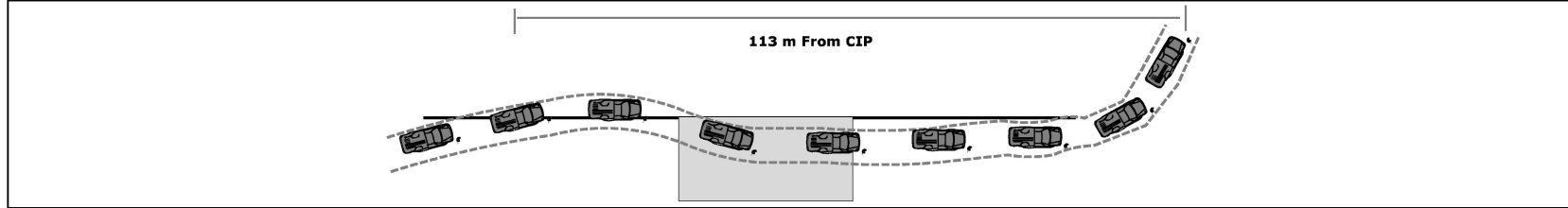

Test Article:	Highway Guard	Post Impact Vehicle Behaviour	
Total Length	120.0 m	Vehicle Stability	Good
Key Elements - Barrier	MASH TL3-11	Stopping Distance	113 m from CIP
Description	Temporary Steel Barrier 60.0 m Anchor spacing	Vehicle Snagging	None
Length of Barrier Installation	120.0 m	Vehicle Pocketing	None
Barrier Height	800 mm	Occupant Impact Velocity	
Ground Conditions	Asphalt	Longitudinal	3.4 m/s
Test Vehicle		Lateral (optional)	4.0 m/s
Designation	2270P	Occupant Ride-down Deceleration	
Make/Model	Dodge Ram 1500	X-direction	-2.7 (0.2504 - 0.2604 seconds)
Dimensions (LxWxH)	5830 mm x 2000 mm x 1845 mm	Y-direction	9.4 (0.3814 - 0.3914 seconds)
Curb Wt	2248.5 kg	THIV (optional) m/s	5.3 at 0.1808 seconds on left side
Test Inertial Wt	2282.0 kg	PHD (optional) g	9.5 (0.3815 - 0.3915 seconds)
Gross Static	2282.0 kg	ASI (optional)	0.69 (0.0741 - 0.1241 seconds)
Impact Conditions		Test Article Damage	Minor
Speed	98.0 km/h	Test Article Deflections	
Angle	24.6°	Dynamic	1.93 m (6.33 ft)
Impact Point	292 mm Upstream of barrier 11	Permanent	1.42 m (4.66 ft)
Exit Conditions		Working Width	2.32 m (7.61 ft)
Exit Speed:	76.5 km/h estimated	Vehicle Damage Exterior	
Exit Angle:	6.36°	VDS	11LF-3
Test Number	135137.3-11	CDC	11LFEE3
Test Date	10 th May 2019	Maximum Deformation	190 mm (estimated)

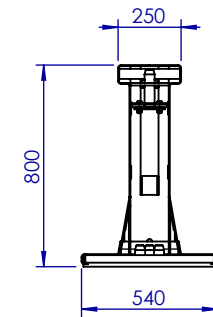
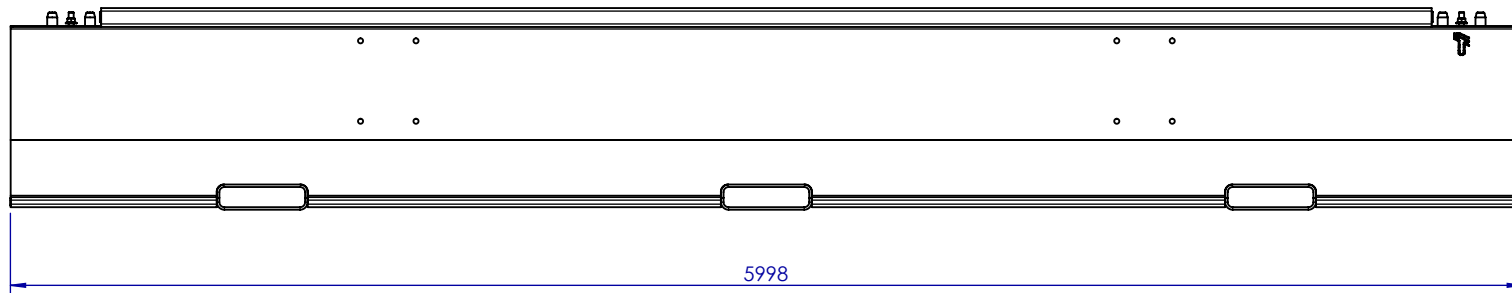
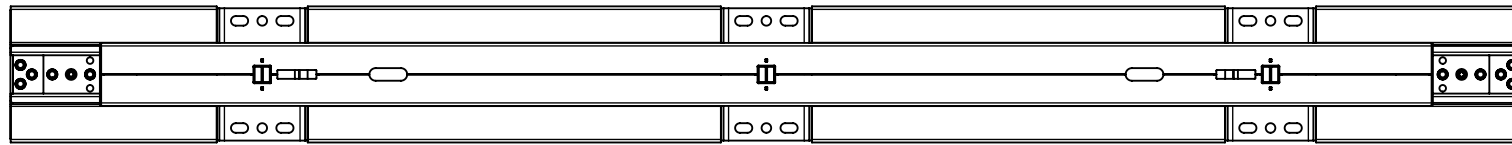
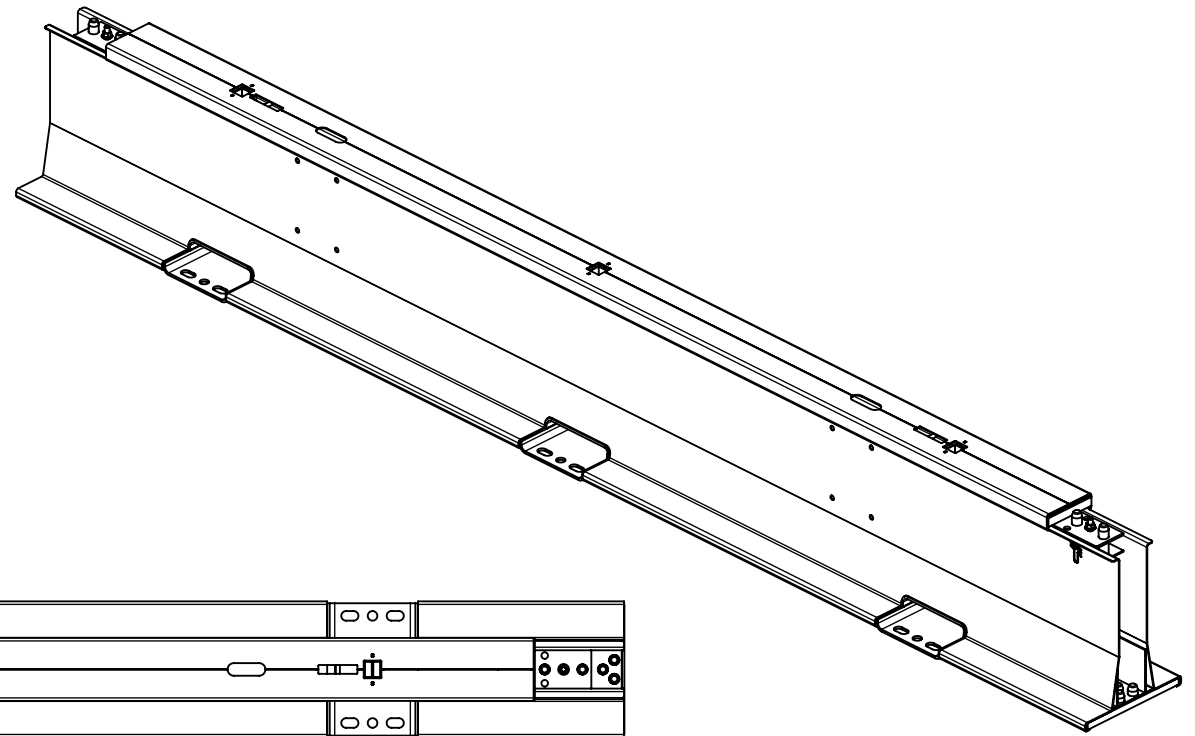

Approx Mass: 517 Kg

Ensure drawing is the correct issue and release before using.

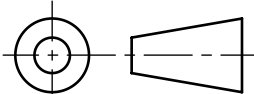

Highway Care LTD
 The Highlands
 Detling
 Maidstone
 Kent ME14 3HT
 Tel. +44 (0) 1622 734215
www.highwaycare.co.uk
 The information herein is proprietary to Highway Care Ltd and shall not be disclosed, duplicated or used otherwise, without the express written approval of Highway Care Ltd.

Rev.	Details.	Dwn.	Date.	Ch'k'd	App'd	Title
A	ECN 324	LH	12/11/18	ST	PD	HighwayGuard - 6m Barrier Assembly
B	ECN 374	LH	03/06/19	ST	PD	
						DWG No. HG-10-01-ID
						SHEET 1 OF 1

ISO A4 Landscape	DO NOT SCALE	SCALE 1:30 ALL DIMENSIONS IN mm	
Revision	B	Status	Released

SHEET 1 OF 1