



U.S. Department  
of Transportation  
**Federal Highway  
Administration**

June 19, 2020

1200 New Jersey Ave., SE  
Washington, D.C. 20590

In Reply Refer To:  
HSST-1/B-316A

Mr. Ron Faulkenberry  
Gibraltar Global LLC  
1208 Houston Clinton Drive  
Burnet, TX 78611  
United States

Dear Mr. Faulkenberry:

On February 27, 2020, The Federal Highway Administration's Office of Safety issued eligibility letter B-316 for the Gibraltar Global TL-4 Cable Barrier System. The Office of Safety has recently made modifications to its eligibility letter website to be more consistent with the 2<sup>nd</sup> Edition of American Association of State Highway and Transportation Officials' (AASHTO's) Manual for Assessing Safety Hardware (MASH) and the additional test matrices for cable barriers therein. These modifications have necessitated the update of certain eligibility letters including B-316. The modification for B-316 consists of adding the phrase "Level Terrain" after the original description of the device to indicate the as-tested conditions.

Please note that this updated letter B-316A will in no way affect the eligibility for the associated device as was determined on February 27, 2020. This letter will supersede the original letter B-316 in full.

### **Decision**

The following device is eligible within the length-of-need, with details provided in the form which is attached as an integral part of this letter:

- Gibraltar Global TL-4 Cable Barrier System, Level Terrain

### **Scope of this Letter**

To be found eligible for Federal-aid funding, new roadside safety devices should meet the crash test and evaluation criteria contained in the American Association of State Highway and Transportation Officials' (AASHTO) Manual for Assessing Safety Hardware (MASH). However, the FHWA, the Department of Transportation, and the United States Government do not regulate the manufacture of roadside safety devices. Eligibility for reimbursement under the Federal-aid highway program does not establish approval, certification or endorsement of the device for any particular purpose or use.

This letter is not a determination by the FHWA, the Department of Transportation, or the United States Government that a vehicle crash involving the device will result in any particular outcome, nor is it a guarantee of the in-service performance of this device. Proper

manufacturing, installation, and maintenance are required in order for this device to function as tested.

This finding of eligibility is limited to the crashworthiness of the system and does not cover other structural features, nor conformity with the Manual on Uniform Traffic Control Devices.

### **Eligibility for Reimbursement**

Based solely on a review of crash test results and certifications submitted by the manufacturer, and the crash test laboratory, FHWA agrees that the device described herein meets the crash test and evaluation criteria of the AASHTO's MASH. Therefore, the device is eligible for reimbursement under the Federal-aid highway program if installed under the range of tested conditions.

Name of system: Gibraltar Global TL-4 Cable Barrier System, Level Terrain

Type of system: Longitudinal Barrier

Test Level: MASH Test Level 4 (TL4)

Testing conducted by: KARCO Engineering

Date of request: November 02, 2018

FHWA concurs with the recommendation of the accredited crash testing laboratory on the attached form.

### **Full Description of the Eligible Device**

The device and supporting documentation, including reports of the crash tests or other testing done, videos of any crash testing, and/or drawings of the device, are described in the attached form.

### **Notice**

This eligibility letter is issued for the subject device as tested. Modifications made to the device are not covered by this letter. Any modifications to this device should be submitted to the user (i.e., state DOT) as per their requirements.

You are expected to supply potential users with sufficient information on design, installation and maintenance requirements to ensure proper performance.

You are expected to certify to potential users that the hardware furnished has the same chemistry, mechanical properties, and geometry as that submitted for review, and that it will meet the test and evaluation criteria of AASHTO's MASH.

Issuance of this letter does not convey property rights of any sort or any exclusive privilege. This letter is based on the premise that information and reports submitted by you are accurate and

correct. We reserve the right to modify or revoke this letter if: (1) there are any inaccuracies in the information submitted in support of your request for this letter, (2) the qualification testing was flawed, (3) in-service performance or other information reveals safety problems, (4) the system is significantly different from the version that was crash tested, or (5) any other information indicates that the letter was issued in error or otherwise does not reflect full and complete information about the crashworthiness of the system.

### Standard Provisions

- To prevent misunderstanding by others, this letter of eligibility designated as FHWA control number B-316A shall not be reproduced except in full. This letter and the test documentation upon which it is based are public information. All such letters and documentation may be reviewed upon request.
- This letter shall not be construed as authorization or consent by the FHWA to use, manufacture, or sell any patented system for which the applicant is not the patent holder.
- This FHWA eligibility letter is not an expression of any Agency view, position, or determination of validity, scope, or ownership of any intellectual property rights to a specific device or design. Further, this letter does not impute any distribution or licensing rights to the requester. This FHWA eligibility letter determination is made based solely on the crash-testing information submitted by the requester. The FHWA reserves the right to review and revoke an earlier eligibility determination after receipt of subsequent information related to crash testing.

Sincerely,

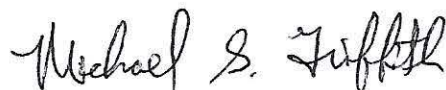

Michael S. Griffith  
Director, Office of Safety Technologies  
Office of Safety

Enclosures

## Request for Federal Aid Reimbursement Eligibility of Highway Safety Hardware

<b>Submitter</b>	Date of Request:	November 02, 2018	<input checked="" type="radio"/> New <input type="radio"/> Resubmission
	Name:	Robert Ramirez	
	Company:	KARCO Engineering	
	Address:	9270 Holly Rd. Adelanto, CA 92301	
	Country:	United States	
	To:	Michael S. Griffith, Director FHWA, Office of Safety Technologies	

I request the following devices be considered eligible for reimbursement under the Federal-aid highway program.

**Device & Testing Criterion** - Enter from right to left starting with Test Level

!-!-!

System Type	Submission Type	Device Name / Variant	Testing Criterion	Test Level
'B': Rigid/Semi-Rigid Barriers (Roadside, Median, Bridge Railings)	<input checked="" type="radio"/> Physical Crash Testing <input type="radio"/> Engineering Analysis	Gibraltar Global TL-4 Cable Barrier System	AASHTO MASH	TL4

By submitting this request for review and evaluation by the Federal Highway Administration, I certify that the product(s) was (were) tested in conformity with the AASHTO Manual for Assessing Safety Hardware and that the evaluation results meet the appropriate evaluation criteria in the MASH.

**Individual or Organization responsible for the product:**

Contact Name:	Ron Faulkenberry	Same as Submitter <input type="checkbox"/>
Company Name:	Gibraltar Global LLC	Same as Submitter <input type="checkbox"/>
Address:	1208 Houston Clinton Drive, Burnet, TX 78611	Same as Submitter <input type="checkbox"/>
Country:	United States	Same as Submitter <input type="checkbox"/>

Enter below all disclosures of financial interests as required by the FHWA 'Federal-Aid Reimbursement Eligibility Process for Safety Hardware Devices' document.

All MASH testing was conducted at Karco Engineering in Adelanto, CA. Karco Engineering was compensated for conducting the tests but has no financial nor patent interests in any of Gibraltar's products.

## PRODUCT DESCRIPTION

<input checked="" type="radio"/> New Hardware or Significant Modification	<input type="radio"/> Modification to Existing Hardware	
<p>The Gibraltar Global TL-4 Cable Barrier System is a high tension 4-cable longitudinal barrier. The barrier consists of four (4) 0.75 in. (19 mm) steel cables, C-section steel posts, steel sockets, aluminum hair pins and steel lock plates. The C-section posts were placed on alternate sides of the 4 cables and are held in place by the aluminum hair pins. The top two (2) cables of the system were stitched together making the cables alternate in the top hairpin location. The hair pins held the cables at 20.0 in (508 mm), 30.0 in (762 mm) and 39.0 in. (991 mm) above grade. The system can be installed with post spacing ranging from 7 ft. to 21 ft.</p> <p>Gibraltar also offers various post and socket options such as concrete socket foundations with steel or plastic sockets, driven steel sockets, and direct driven posts. Other options include swaged and wedge-type fittings which were installed and crash tested. Pre-stretched and non pre-stretched cable are permissible.</p>		
<h3>CRASH TESTING</h3>		
<p>By signature below, the Engineer affiliated with the testing laboratory, agrees in support of this submission that all of the critical and relevant crash tests for this device listed above were conducted to meet the MASH test criteria. The Engineer has determined that no other crash tests are necessary to determine the device meets the MASH criteria.</p>		
Engineer Name:	Robert Ramirez	
Engineer Signature:	Robert Ramirez	Digitally signed by Robert Ramirez DN: cn=Robert Ramirez, o=KARCO Engineering, ou=Project Engineer, email=rramirez@karco.com, c=US Date: 2018.11.01 15:54:48 -07'00'
Address:	9270 Holly Rd. Adelanto, CA 92301	Same as Submitter <input type="checkbox"/>
Country:	United States	Same as Submitter <input type="checkbox"/>

A brief description of each crash test and its result:

Required Test Number	Narrative Description	Evaluation Results
4-10 (1100C)	KARCO Engineering Project number P37379-01 was conducted with an 1100C test vehicle impacting the system midspan between posts at a nominal velocity and angle of 62 mph and 25 degrees, respectively. As recommend by MASH 2016 the narrowest allowable post spacing of 7.0 ft. (2.1 m) was used. The test vehicle, a 2011 Kia Rio weighing 2,427.2 lbs (1,101.0 kg) impacted the system at a speed and angle of 62.38 mph (100.39 km/h) and 25.1 degrees, respectively. The system redirected the vehicle and had a maximum working width of 7.6 ft. (2.3 m). The test vehicle sustained moderate damage. There was no potential for the article to penetrate the vehicle and the occupant compartment deformation limits were not exceeded. The Occupant Impact Velocities (OIV) and ridedown accelerations are within the recommended limits.	PASS

Required Test Number	Narrative Description	Evaluation Results
4-11 (2270P)	<p>As recommend by MASH 2016 the narrowest allowable post spacing of 7.0 ft. (2.1 m) and the widest allowable post spacing of 21.0 ft. (6.4 m) was tested with the 2270P test vehicle.</p> <p>KARCO Engineering Project number P37358-01 was conducted with a 2270P test vehicle impacting the system 1.0 ft. (0.3 m) upstream of a post with the narrowest allowable post spacing of 7.0 ft. (2.1 m) at a nominal velocity and angle of 62 mph and 25 degrees, respectively. The test vehicle, a 2013 Chevrolet Silverado weighing 5,011.0 lbs (2,273.0 kg) impacted the system at a speed and angle of 60.93 mph (98.06 km/h) and 25.3 degrees, respectively. The system redirected the vehicle and had a maximum working width of 7.9 ft. (2.4 m). The test vehicle sustained moderate damage. There was no potential for the article to penetrate the vehicle and the occupant compartment deformation limits were not exceeded. The Occupant Impact Velocities (OIV) and ridedown accelerations are within the recommended limits.</p> <p>KARCO Engineering Project number P37359-01 was conducted with a 2270P test vehicle impacting the system 1.0 ft. (0.3 m) upstream of a post with the widest allowable post spacing of 21.0 ft (6.4 m) at a nominal velocity and angle of 62 mph and 25 degrees, respectively. The test vehicle, a 2013 Chevrolet Silverado weighing 5,028.7 lbs (2,281.0 kg) impacted the system at a speed and angle of 61.78 mph (99.43 km/h) and 25.1 degrees, respectively. The system redirected the vehicle and had a maximum working width of 13.8 ft. (4.2 m). The test vehicle sustained moderate damage. There was no potential for the article to penetrate the vehicle and the occupant compartment deformation limits were not exceeded. The Occupant Impact Velocities (OIV) and ridedown accelerations are within the recommended limits.</p>	PASS

4-12 (10000S)	KARCO Engineering Project number P37320-01 was conducted with an 10000S test vehicle impacting the system 1.0 ft. (0.3 m) upstream of a post at a nominal velocity and angle of 56 mph and 15 degrees, respectively. The largest allowable post spacing of 21.0 ft. (6.4 m) was tested to increase the loading on the splices. The test vehicle, a 2007 Ford F650 weighing 22,641.1 lbs (10,270.0 kg) impacted the system at a speed and angle of 54.39 mph (87.54 km/h) and 14.9 degrees, respectively. The system redirected the vehicle and had a maximum working width of 17.4 ft. (5.3 m). The maximum test debris was approximately 25 ft. laterally to the non-traffic side of the barrier. The test vehicle sustained moderate damage. There was no potential for the article to penetrate the vehicle and the occupant compartment deformation limits were not exceeded.	PASS
4-20 (1100C)	Test 4-20 is not applicable for this type of system.	Non-Relevant Test, not conducted
4-21 (2270P)	Test 4-21 is not applicable for this type of system.	Non-Relevant Test, not conducted
4-22 (10000S)	Test 4-22 is not applicable for this type of system.	Non-Relevant Test, not conducted

Full Scale Crash Testing was done in compliance with MASH by the following accredited crash test laboratory (cite the laboratory's accreditation status as noted in the crash test reports.):

Laboratory Name:	Applus IDIADA KARCO Engineering	
Laboratory Signature:		Digitally signed by Alex Beltran DN: cn=Alex Beltran, o=KARCO Engineering, ou=Testing Laboratory, email=abeltran@karco.com, c=US Date: 2018.11.01 15:51:22 -0700
Address:	9270 Holly Rd. Adelanto CA. 92301	Same as Submitter <input type="checkbox"/>
Country:	United States	Same as Submitter <input type="checkbox"/>
Accreditation Certificate Number and Dates of current Accreditation period :	TL-371 valid up to July 1, 2019	

Submitter Signature\*: Robert Ramirez

Digitally signed by Robert Ramirez  
DN: cn=Robert Ramirez, o=KARCO Engineering, ou=Project Engineer,  
email=r Ramirez@karco.com, c=US  
Date: 2018.11.02 08:22:48 -0700

Submit Form

ATTACHMENTS

Attach to this form:

- 1) Additional disclosures of related financial interest as indicated above.
- 2) A copy of the full test report, video, and a Test Data Summary Sheet for each test conducted in support of this request.
- 3) A drawing or drawings of the device(s) that conform to the Task Force-13 Drawing Specifications [[Hardware Guide Drawing Standards](#)]. For proprietary products, a single isometric line drawing is usually acceptable to illustrate the product, with detailed specifications, intended use, and contact information provided on the reverse. Additional drawings (not in TF-13 format) showing details that are relevant to understanding the dimensions and performance of the device should also be submitted to facilitate our review.

FHWA Official Business Only:

Eligibility Letter		
Number	Date	Key Words



## MASH Test 4-10 Summary

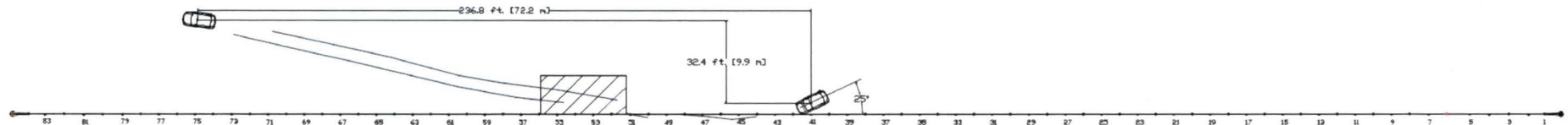
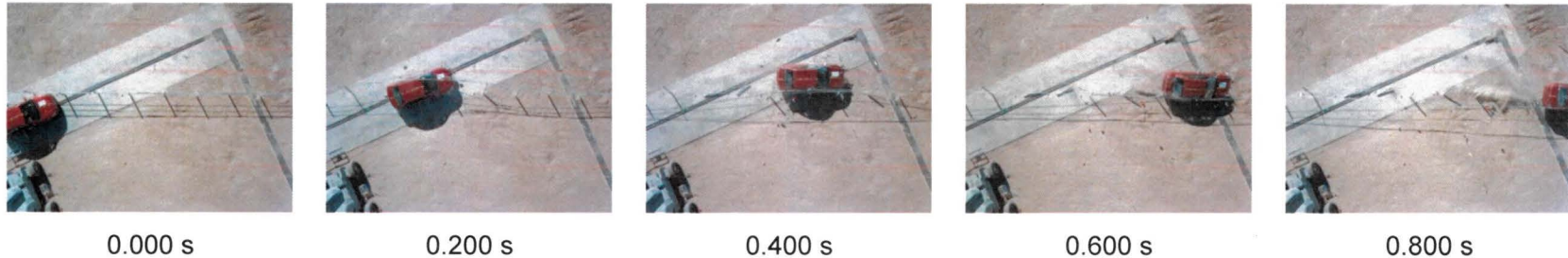

<b>GENERAL INFORMATION</b>	
Test Agency.....	KARCO Engineering, LLC.
KARCO Test No.....	P3791-01
Test Designation.....	4-10
Test Date.....	12/06/17
<b>TEST ARTICLE</b>	
Name / Model.....	TL-4 Cable Barrier System
Type.....	Longitudinal Barrier
Installation Length.....	597.7 ft. (182.2 m)
Post Spacing.....	7.0 ft. (2.1 m)
Key Elements.....	Cable, Hair Pins, Lock Plates
Road Surface.....	Concrete and Soil
Type / Designation.....	1100C
Year, Make, and Model.....	2011 Kia Rio
Curb Mass.....	2,489.0 lbs (1,129.0 kg)
Test Inertial Mass.....	2,427.2 lbs (1,101.0 kg)
Gross Static Mass.....	2,621.3 lbs (1,189.0 kg)

<b>Impact Conditions</b>	
Impact Velocity.....	62.38 mph (100.39 km/h)
Impact Angle.....	25.1°
Location / Orientation.....	3.5 ft. (1.1 m) upstream of Post 42
Impact Severity.....	56.8 kip-ft (77.0 kJ)
<b>Exit Conditions</b>	
Exit Velocity.....	50.2 mph (80.8 km/h)
Exit Angle.....	7.1°
Final Vehicle Position.....	236.8 ft. (72.2 m) Downstream
	32.4 ft. (9.9 m) Right
Exit Box Criterion.....	Exited within exit box
Vehicle Snagging.....	Satisfactory
Vehicle Pocketing.....	Satisfactory
Maximum Roll Angle.....	23.4°
Maximum Pitch Angle.....	8.3°
Maximum Yaw Angle.....	-30.0°

<b>Occupant Risk</b>	
Longitudinal OIV.....	15.7 ft/s (4.8 m/s)
Lateral OIV.....	13.5 ft/s (4.1 m/s)
Longitudinal RA.....	-3.8 g
Lateral RA.....	5.2 g
THIV.....	23.3 ft/s (7.1 m/s)
PHD.....	5.5 g
ASI.....	0.50
<b>Test Article Deflections</b>	
Static.....	N/A
Dynamic.....	78.5 in. (2.0 m)
Working Width.....	90.9 in. (2.3 m)
Debris Field.....	13.0 ft. (4.0 m)
	Field Side
<b>Vehicle Damage</b>	
Vehicle Damage Scale.....	11LFQ6
CDC.....	11LYAK8
Maximum Intrusion.....	1.0 in. (25 mm)

Figure 3 Summary of Test 4-10

## MASH Test 4-11 Summary

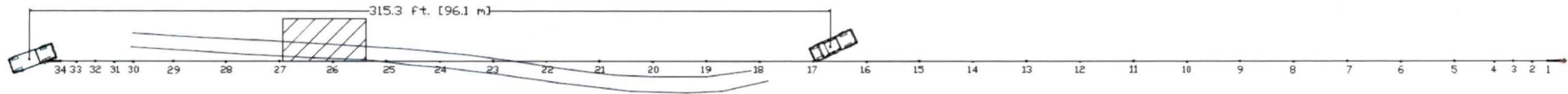
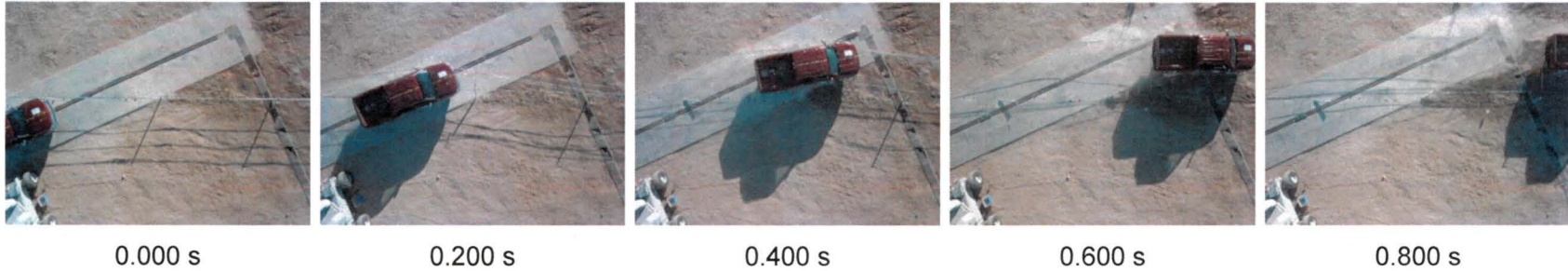

<b>GENERAL INFORMATION</b>	
Test Agency.....	Applus IDIADA KARCO
KARCO Test No.....	P37359-01
Test Designation.....	4-11
Test Date.....	12/07/18
<b>TEST ARTICLE</b>	
Name / Model.....	TL-4 Cable Barrier System
Type.....	Longitudinal Barrier
Installation Length.....	597.7 ft. (182.2 m)
Post Spacing.....	21.0 ft. (6.4 m)
Key Elements.....	Cable, Hair Pins, Lock Plates
Road Surface.....	Concrete and Soil
<b>TEST VEHICLE</b>	
Type / Designation.....	2270P
Year, Make, and Model.....	2013 Chevrolet Silverado 1500
Curb Mass.....	5,067.2 lbs (2,298.5 kg)
Test Inertial Mass.....	5,028.7 lbs (2,281.0 kg)
Gross Static Mass.....	5,028.7 lbs (2,281.0 kg)

<b>Impact Conditions</b>	
Impact Velocity.....	61.78 mph (99.43 km/h)
Impact Angle.....	25.1°
Location / Orientation.....	11.5 in. (292 mm) upstream from post 17
Impact Severity.....	115.5 kip-ft (156.5 kJ)
<b>Exit Conditions</b>	
Exit Velocity.....	47.40 mph (76.28 km/h)
Exit Angle.....	2.4°
Final Vehicle Position.....	315.3 ft. (96.1 m ) Downstream
	0.7 ft. (0.2 m) Traffic side
Exit Box Criteria Met.....	Yes
Vehicle Snagging.....	Satisfactory
Vehicle Pocketing.....	Satisfactory
Maximum Roll Angle.....	-3.1 °
Maximum Pitch Angle.....	-2.9 °
Maximum Yaw Angle.....	-25.7 °

<b>Occupant Risk</b>	
Longitudinal OIV.....	8.5 ft/s (2.6 m/s)
Lateral OIV.....	9.5 ft/s (2.9 m/s)
Longitudinal RA.....	-2.6 g
Lateral RA.....	3.4 g
THIV.....	13.1 ft/s (4.0 m/s)
PHD.....	3.7 g
ASI.....	0.31
<b>Test Article Deflections</b>	
Static.....	N/A
Dynamic.....	13.8 ft. (4.2 m)
Working Width.....	13.8 ft. (4.2 m)
Debris (lateral).....	14.5 ft. (4.4 m)
<b>Vehicle Damage*</b>	
Vehicle Damage Scale.....	11-LFQ-3
CDC.....	11LFEN2
Maximum Intrusion.....	none

\*Vehicle damaged assessed before secondary impact.

**Figure 4 Summary of Test 4-11**

## MASH Test 4-11 Summary

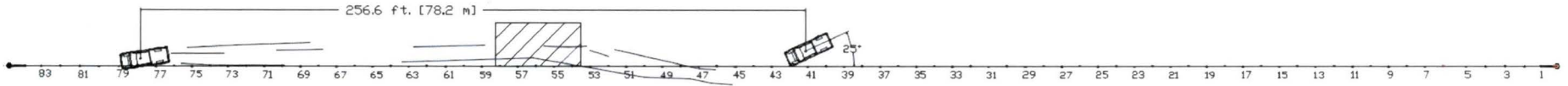
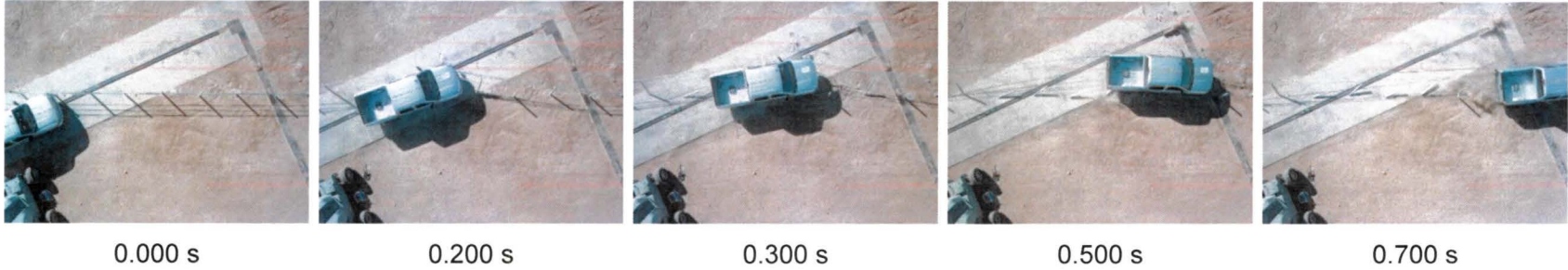

<b>GENERAL INFORMATION</b>	
Test Agency.....	Applus IDIADA KARCO
KARCO Test No.....	P37358-01
Test Designation.....	4-11
Test Date.....	12/07/18
<b>TEST ARTICLE</b>	
Name / Model.....	TL-4 Cable Barrier System
Type.....	Longitudinal Barrier
Installation Length.....	597.7 ft. (182.2 m)
Post Spacing.....	7.0 ft (2.1 m)
Key Elements.....	Cable, Hair Pins, Lock Plates
Road Surface.....	Concrete and soil
<b>TEST VEHICLE</b>	
Type / Designation.....	2270P
Year, Make, and Model....	2013 Chevrolet Silverado 1500
Curb Mass.....	5,261.2 lbs (2,386.5 kg)
Test Inertial Mass.....	5,011.0 lbs (2,273.0 kg)
Gross Static Mass.....	5,011.0 lbs (2,273.0 kg)

<b>Impact Conditions</b>	
Impact Velocity.....	60.93 mph (98.06 km/h)
Impact Angle.....	25.3°
Location / Orientation.....	1.5 in. upstream from Post 42
Impact Severity.....	113.6 kip-ft (154.0 kJ)
<b>Exit Conditions</b>	
Exit Velocity.....	36.7 mph (59.1 km/h)
Exit Angle.....	6.2°
Final Vehicle Position.....	256.6 ft. (78.2 m ) Downstream
	3.1 ft. (0.9 m) Right
Exit Box Criterion.....	Exited within exit box
Vehicle Snagging.....	None
Vehicle Pocketing.....	None
Maximum Roll Angle.....	5.4 °
Maximum Pitch Angle.....	3.6 °
Maximum Yaw Angle.....	-26.3 °

<b>Occupant Risk</b>	
Longitudinal OIV.....	9.2 ft/s (2.8 m/s)
Lateral OIV.....	12.1 ft/s (3.7 m/s)
Longitudinal RA.....	-4.0 g
Lateral RA.....	5.6 g
THIV.....	15.7 ft/s (4.8 m/s)
PHD.....	5.3 g
ASI.....	0.41
<b>Test Article Deflections</b>	
Static.....	0.5 ft. (0.2 m)
Dynamic.....	7.9 ft. (2.4 m)
Working Width.....	7.9 ft. (2.4 m)
Debris Field.....	10.0 ft. (3.0 m) Field side
<b>Vehicle Damage</b>	
Vehicle Damage Scale.....	11-LFQ-3
CDC.....	11LYEW2
Maximum Intrusion.....	0.5 in. (13 mm)

**Figure 3 Summary of Test 4-11**

## MASH Test 4-12 Summary



0.000 s

0.200 s

0.400 s

0.600 s

0.800 s

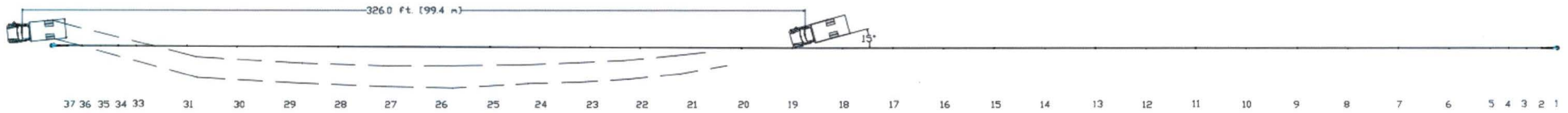

### GENERAL INFORMATION

Test Agency..... Applus IDIADA KARCO  
 KARCO Test No..... P37320-01  
 Test Designation..... 4-12  
 Test Date..... 12/5/17

### TEST ARTICLE

Name / Model..... TL-4 Cable Barrier  
 Type..... Longitudinal Barrier  
 Installation Length..... 625.7 ft. (190.7 m)  
 Key Elements..... Cable, Hair Pins, Lock Plates  
 Road Surface..... Concrete and Soil

### TEST VEHICLE

Type / Designation..... 10000S  
 Year, Make, and Model.... 2007 Ford F-750  
 Curb Mass..... 16,210.5 lbs (7,353.1 kg)  
 Test Inertial Mass..... 22,641.1 lbs (10,270.0 kg)  
 Gross Static Mass..... 22,641.1 lbs (10,270.0 kg)

### Impact Conditions

Impact Velocity..... 54.39 mph (87.53 km/h)  
 Impact Angle..... 14.9°  
 Location / Orientation..... 1.0. ft. Upstream of Post  
 Impact Severity..... 148.0 kip-ft (200.7 kJ)

### Exit Conditions

Exit Velocity..... N/A  
 Exit Angle..... 3.2°  
 Final Vehicle Position..... 326.0 ft. (99.4 m) downstream  
 Exit Box Criteria Met..... N/A  
 Vehicle Snagging..... None  
 Vehicle Pocketing..... None  
 Maximum Roll Angle..... N/A  
 Maximum Pitch Angle..... N/A  
 Maximum Yaw Angle..... N/A

### Occupant Risk

Longitudinal OIV..... N/A  
 Lateral OIV..... N/A  
 Longitudinal RA..... N/A  
 Lateral RA..... N/A  
 THIV..... N/A  
 PHD..... N/A  
 ASI..... N/A

### Test Article Deflections

Static..... 5.0 ft. (1.5 m)  
 Dynamic..... N/A\*  
 Working Width..... 17.4 ft. (5.3 m)

### Vehicle Damage

Vehicle Damage Scale..... 12-FL-2  
 CDC..... 12FLDW1  
 Maximum Intrusion..... No measureable deformation

\*Cable wrapped around vehicle. Measurement unable to be taken.

Figure 3 Summary of Test 4-12

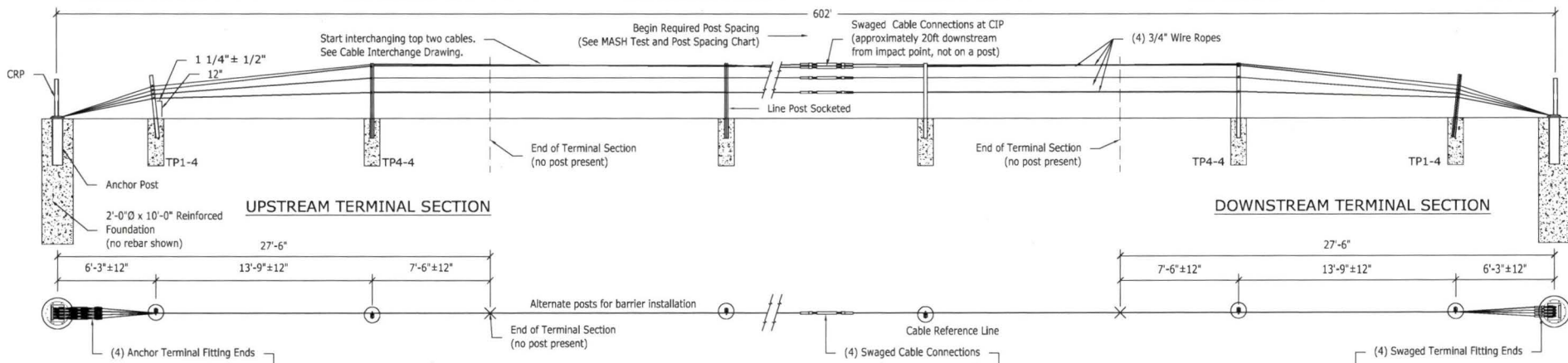

**UPSTREAM TERMINAL SECTION**

**DOWNSTREAM TERMINAL SECTION**

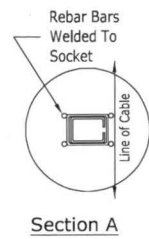
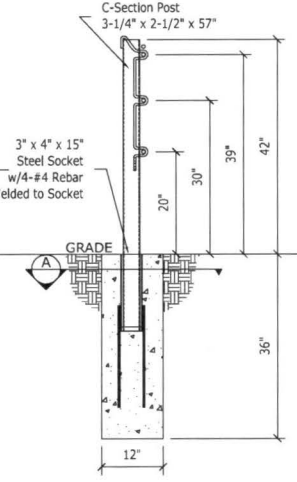
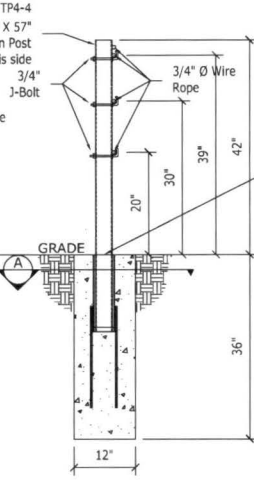
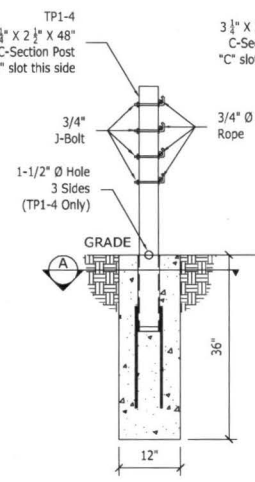
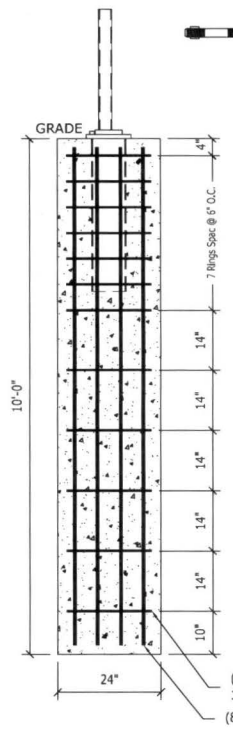
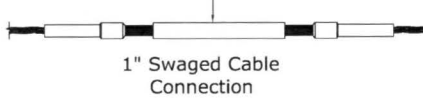
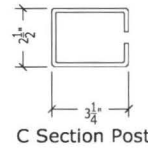

**Cable Tension Chart\***

-10 °F	8600
0 °F	8200
10 °F	7800
20 °F	7400
30 °F	7000
40 °F	6600
50 °F	6200
60 °F	5800
70 °F	5400
80 °F	5000
90 °F	4600
100 °F	4200
110 °F	3800

**TL-4 4 Cable MASH Test and Post Spacing Chart**

MASH TEST	Line Post Spacing*
3-10	7'-0"
3-11	7'-0"
3-11	21'-0"
4-12**	21'-0"

\*±6" post spacing tolerance  
 \*\*All tests are impacted near the midpoint of the installation at a 25° angle, except the 4-12 test, which is impacted at 15°.

\*Allowable Deviation from Chart +/- 10%

**MASH 4 Cable Tests PROPRIETARY TO GIBRALTAR**

**TL-4 4 Cable System Layout**

Gibraltar Cable Barrier Systems

Scale: **NTS** Date: **12-19-18**

Layout: **ANSI B** Drafter: **JP**

**Cable Release & Anchor Post**

**Terminal Post (Welded Rebar Socket)**

**Terminal Post (Welded Rebar Socket)**

**Line Post (Welded Rebar Socket)**

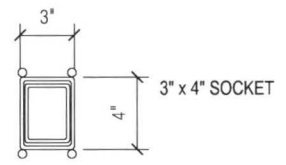
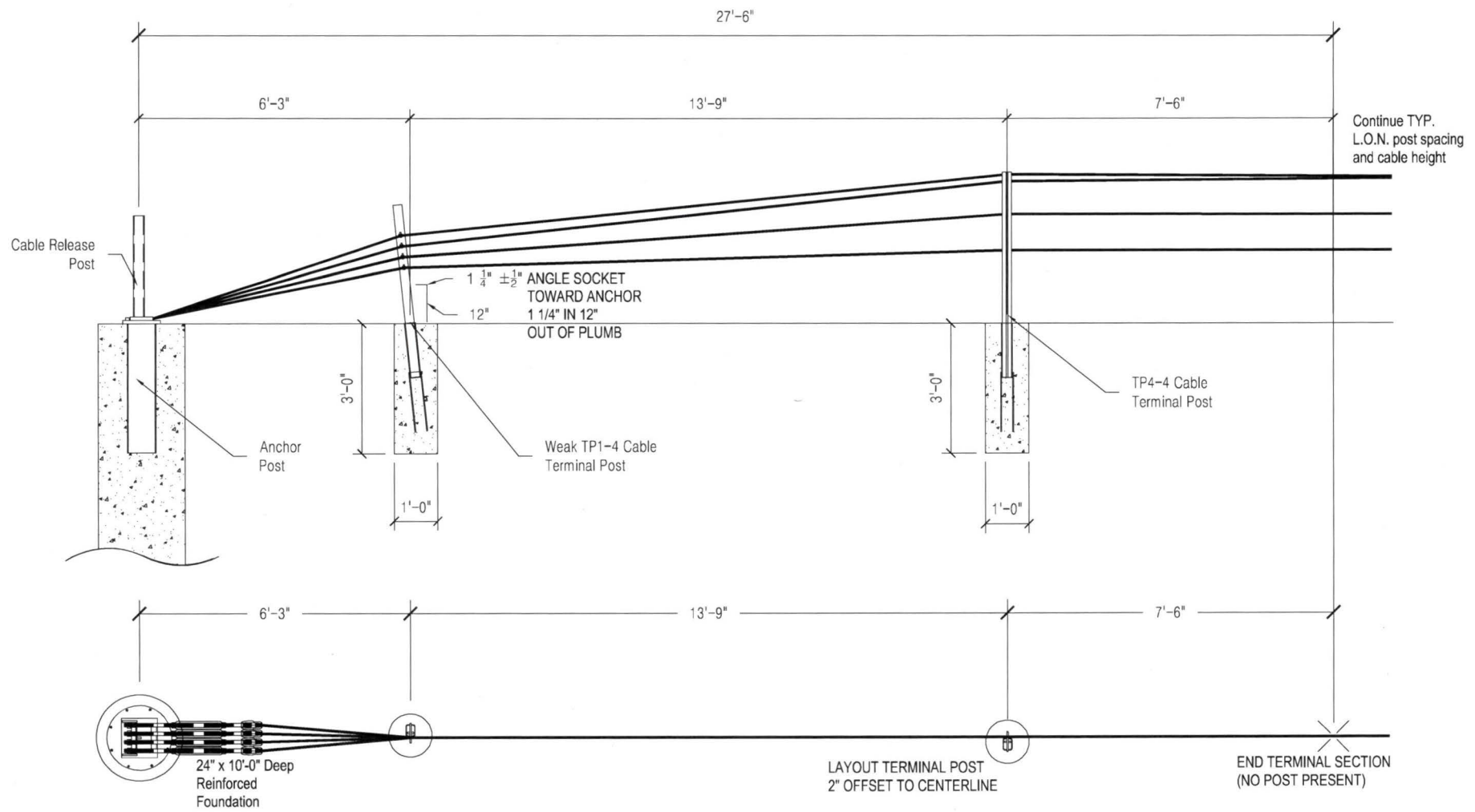

**PROPRIETARY TO GIBRALTAR**



<b>TL-3 4-Cable MASH Terminal Layout</b>	
Gibraltar Cable Barrier Systems	
Scale: <b>NTS</b>	Date: <b>1-7-19</b>
Layout: <b>ANSI B</b>	Drafter: <b>BH</b>

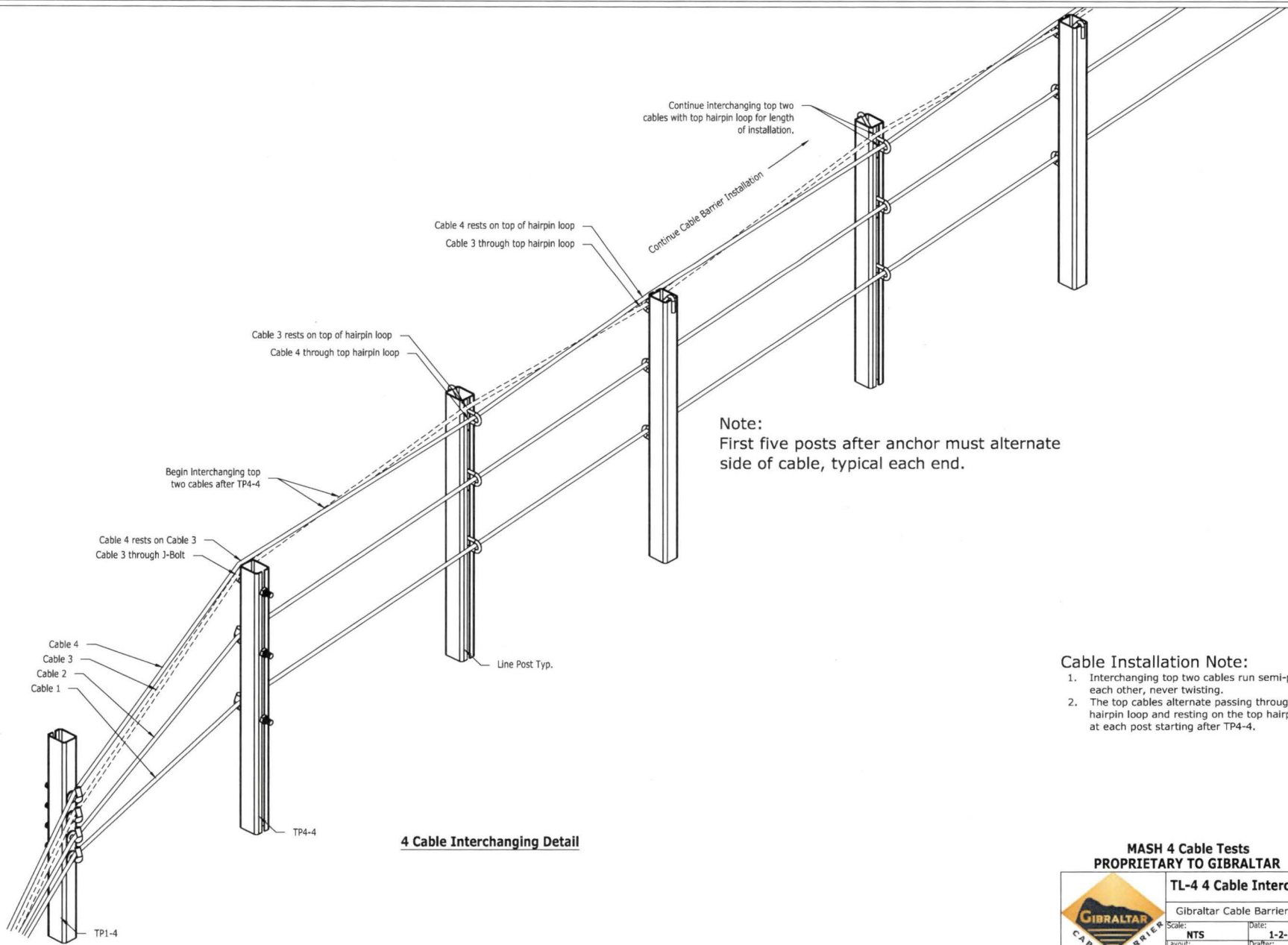

**4 Cable Interchanging Detail**

**Note:**  
First five posts after anchor must alternate side of cable, typical each end.

- Cable Installation Note:**
1. Interchanging top two cables run semi-parallel to each other, never twisting.
  2. The top cables alternate passing through the top hairpin loop and resting on the top hairpin loop at each post starting after TP4-4.

**MASH 4 Cable Tests  
PROPRIETARY TO GIBRALTAR**

	<b>TL-4 4 Cable Interchanging</b>	
	Gibraltar Cable Barrier Systems	
	Scale: <b>NTS</b>	Date: <b>1-2-19</b>
	Layout: <b>ANSI B</b>	Drafter: <b>JP</b>

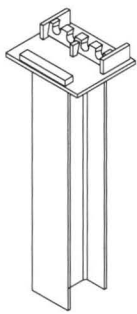

Anchor Post



Cable Release Post

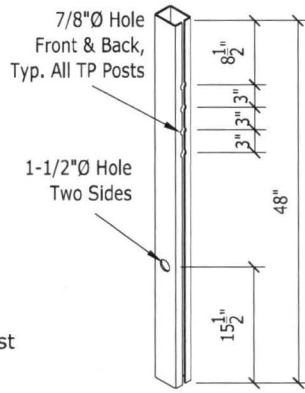

**TP1-4**  
Terminal Post  
No. 1/Weak

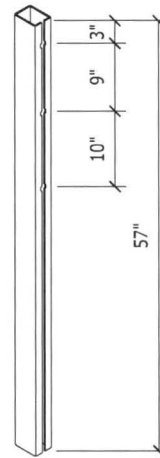

**TP4-4**  
Terminal Post

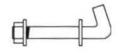

**J-BLT**  
J-Bolt

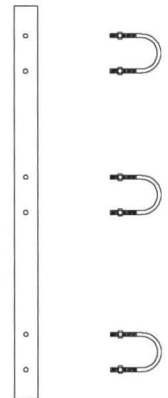

**U-Bolt Lock-Plate Assembly**



**RH STUD ATF ASSY**  
Anchor Terminal Fitting RH Stud



**ATF**  
Anchor Terminal Fitting



**ATF-END**  
Anchor Terminal Fitting End

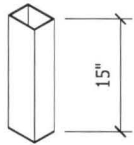

Tube Socket  
(Steel or Plastic)

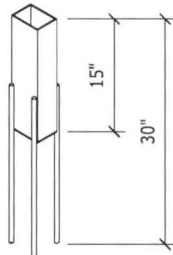

**SOCK-S**  
Short Rebar Socket

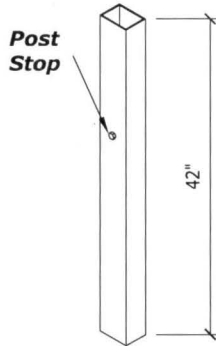

**TUBE-D**  
Driven Socket

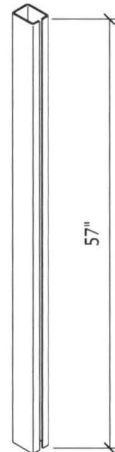

**4-LNP-S**  
Line Post/Socketed

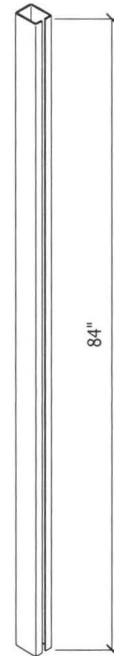

**4-LNP-D**  
Line Post/Driven



**4-HPIN ALUM**



**4-LOCK**  
TL4 Lockplate



**RH/LH SWAGE ASSY**



**CSTB**  
Cable Splice Turnbuckle



**WEDGE**  
W-1 Wedge



**ACORN**  
Acorn w/ Wedge



**TORP**  
Longitudinal Section ONLY  
Torpedo Cable Splice

**PROPRIETARY TO GIBRALTAR**



**TL4 MASH System Parts**

Gibraltar Cable Barrier Systems

Scale:	Date:
<b>NTS</b>	<b>12/19/18</b>
Layout:	Drafter:
<b>ANSI B</b>	<b>BH</b>



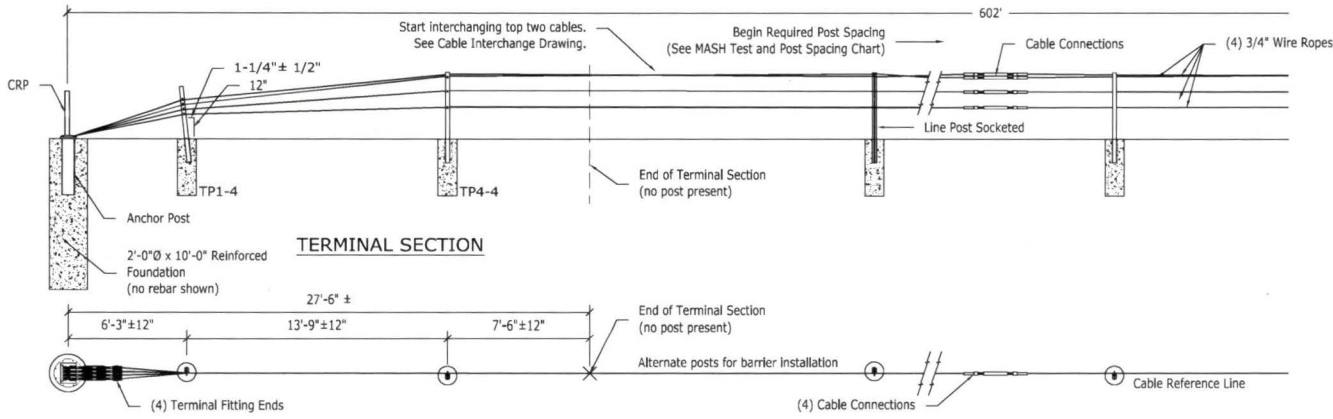

**TERMINAL SECTION**

RH STUD ATF ASSY  
Anchor Terminal Fitting RH Stud



ATF  
Anchor Terminal Fitting

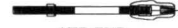

ATF-END  
Anchor Terminal Fitting End

RH/LH SWAGE ASSY



LON Fittings  
Cable Splice Turnbuckle

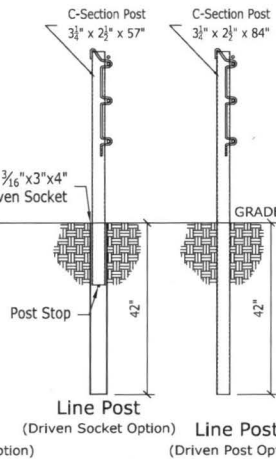
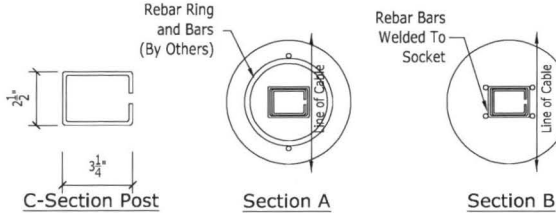
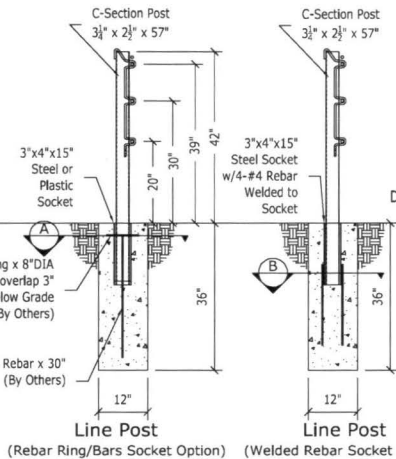
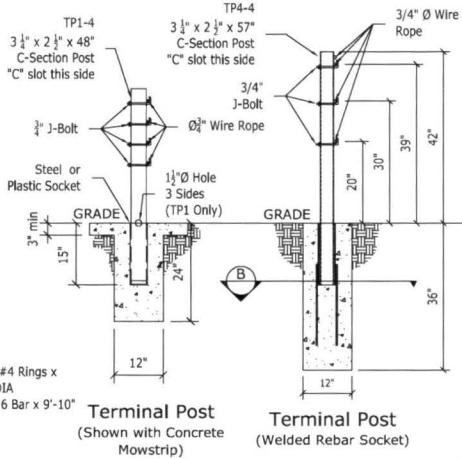
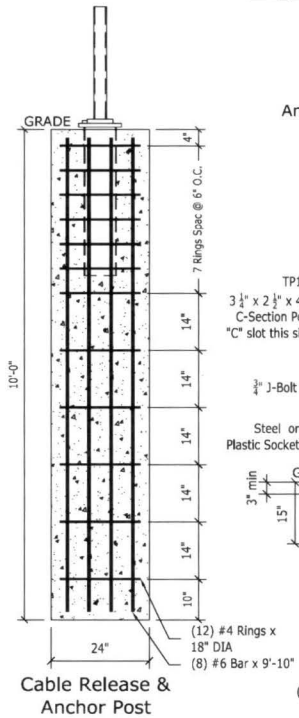

**GENERAL NOTES:**

- For additional information contact Gibraltar, Inc. at 1-833-715-0810 or see the manufacturer's product manual.
- All concrete shall be per specification; minimum 2500 PSI.
- The Cable Barrier System shall be installed on shoulders or on medians with slopes of 6:1 or flatter. If installed on slopes steeper than 6:1 up to 4:1 the TL-4 system performs as a TL-3 and Gibraltar must be contacted for various guidelines related to placement. (Max. Post Spacing 18' on 4:1)
- The Cable Barrier System is accepted by the FHWA Test Level - 4.
- See the specification for delineation.
- Rock Clause: Where solid rock is encountered:
  - For socketed post, continue digging 12" diameter, 15" deep into rock or the required plan depth, whichever comes first.
  - For driven post, core drill a 4" diameter hole 18" deep into rock or the required plan depth, whichever comes first.
  - For Anchor post, continue digging 24" diameter, 30" deep into rock or the required plan depth, whichever comes first.
- The Gibraltar cable barrier system shall be installed in standard compacted soil. Soil must be well drained.
- All non-welded rebar by others.
- Minimum recommended line post foundation.
  - Without mowstrip, 36" Deep x 12" diameter foundations with #3 rebar ring x 8" diameter with two #4 rebar vertical bars 30" long or 30" welded rebar socket.
  - With 4" minimum depth hot mix asphalt, 30" deep x 12" diameter foundations with #3 rebar ring x 8" diameter with two #4 rebar vertical bars 30" long or 30" welded rebar socket.
  - With 3" minimum depth concrete mowstrip, 24" deep x 12" diameter foundations. (No rebar required).
- Direct drive driven post and driven socket 42" deep.

**Cable Tension Chart\***

-10 °F	8600
0 °F	8200
10 °F	7800
20 °F	7400
30 °F	7000
40 °F	6600
50 °F	6200
60 °F	5800
70 °F	5400
80 °F	5000
90 °F	4600
100 °F	4200
110 °F	3800

**TL-4 4 Cable MASH Test and Post Spacing Chart**

MASH TEST	Line Post Spacing
3-10	7'-0"
3-11	7'-0"
3-11	21'-0"
4-12	21'-0"

\*±6" post spacing tolerance

\*Allowable Deviation from Chart +/- 10%

**MASH 4 Cable Tests PROPRIETARY TO GIBRALTAR**

**TL-4 4M Cable System Layout**

Gibraltar Cable Barrier Systems

Scale: **NTS**      Date: **1-7-2019**

Layout: **ANSI B**      Drafter: **BH**