



U.S. Department
of Transportation
**Federal Highway
Administration**

1200 New Jersey Ave., SE
Washington, D.C. 20590

June 1, 2016

In Reply Refer To:
HSST-1/B-176B

Mr. Gary Lallo
Hill and Smith Ltd
987 Buckeye Road
Columbus, OH 43207

Dear Mr. Lallo:

This letter is in response to your March 17, 2016 request for the Federal Highway Administration (FHWA) to review a roadside safety device, hardware, or system for eligibility for reimbursement under the Federal-aid highway program. This FHWA letter of eligibility is assigned FHWA control number B-176B and is valid until a subsequent letter is issued by FHWA that expressly references this device.

Decision

The following devices are eligible, with details provided in the form which is attached as an integral part of this letter:

- Zoneguard, Asphalt

Scope of this Letter

To be found eligible for Federal-aid funding, new roadside safety devices should meet the crash test and evaluation criteria contained in the American Association of State Highway and Transportation Officials' Manual for Assessing Safety Hardware (MASH). However, the FHWA, the Department of Transportation, and the United States Government do not regulate the manufacture of roadside safety devices. Eligibility for reimbursement under the Federal-aid highway program does not establish approval, certification or endorsement of the device for any particular purpose or use.

This letter is not a determination by the FHWA, the Department of Transportation, or the United States Government that a vehicle crash involving the device will result in any particular outcome, nor is it a guarantee of the in-service performance of this device. Proper manufacturing, installation, and maintenance are required in order for this device to function as tested.

This finding of eligibility is limited to the crashworthiness of the system and does not cover other structural features, nor conformity with the Manual on Uniform Traffic Control Devices.

Eligibility for Reimbursement

Based solely on a review of crash test results and certifications submitted by the manufacturer, and the crash test laboratory, FHWA agrees that the device described herein meets the crash test and evaluation criteria of the American Association of State Highway and Transportation Officials' Manual for Assessing Safety Hardware (MASH). Therefore, the device is eligible for reimbursement under the Federal-aid highway program if installed under the range of tested conditions.

Name of system: Zoneguard, Asphalt
Type of system: Longitudinal Barrier
Test Level: MASH Test Level 3
Testing conducted by: Texas A&M Transportation Institute
Date of request: February 5, 2016
Date of completed package: March 17, 2016

Full Description of the Eligible Device

The device and supporting documentation, including reports of the crash tests or other testing done, videos of any crash testing, and/or drawings of the device, are described in the attached form.

Notice

If a manufacturer makes any modification to any of their roadside safety hardware that has an existing eligibility letter from FHWA, the manufacturer must notify FHWA of such modification with a request for continued eligibility for reimbursement. The notice of all modifications to a device must be accompanied by:

- Significant modifications – For these modifications, crash test results must be submitted with accompanying documentation and videos.
- Non-signification modifications – For these modifications, a statement from the crash test laboratory on the potential effect of the modification on the ability of the device to meet the relevant crash test criteria.

FHWA's determination of continued eligibility for the modified hardware will be based on whether the modified hardware will continue to meet the relevant crash test criteria.

You are expected to supply potential users with sufficient information on design, installation and maintenance requirements to ensure proper performance.

You are expected to certify to potential users that the hardware furnished has the same chemistry, mechanical properties, and geometry as that submitted for review, and that it will meet the test and evaluation criteria of the MASH.

Issuance of this letter does not convey property rights of any sort or any exclusive privilege. This letter is based on the premise that information and reports submitted by you are accurate and correct. We reserve the right to modify or revoke this letter if: (1) there are any inaccuracies in the information submitted in support of your request for this letter, (2) the qualification testing was flawed, (3) in-service performance or other information reveals safety problems, (4) the system is significantly different from the version that was crash tested, or (5) any other information indicates that the letter was issued in error or otherwise does not reflect full and complete information about the crashworthiness of the system.

Standard Provisions

- To prevent misunderstanding by others, this letter of eligibility designated as FHWA control number B-176B shall not be reproduced except in full. This letter and the test documentation upon which it is based are public information. All such letters and documentation may be reviewed upon request.
- This letter shall not be construed as authorization or consent by the FHWA to use, manufacture, or sell any patented system for which the applicant is not the patent holder.
- If the subject device is a patented product it may be considered to be proprietary. If proprietary systems are specified by a highway agency for use on Federal-aid projects: (a) they must be supplied through competitive bidding with equally suitable unpatented items; (b) the highway agency must certify that they are essential for synchronization with the existing highway facilities or that no equally suitable alternative exists; or (c) they must be used for research or for a distinctive type of construction on relatively short sections of road for experimental purposes. Our regulations concerning proprietary products are contained in Title 23, Code of Federal Regulations, Section 635.411.

Sincerely yours,



Michael S. Griffith
Director, Office of Safety Technologies
Office of Safety

Enclosures

Required Test Number	Narrative Description	Evaluation Results
3-10 (1100C)	<p>Test ZG-USA-1 performed previously. For this barrier system, MASH Test 3-10 (2425-lb small car) was not tested because the small car test is not the controlling test for the strength of the barrier system and vehicle stability. MASH Test 3-11 (500D-lb pickup truck) is the controlling test for strength of the barrier system for Test Level 3. Due to the heavier vehicle mass for the pickup, MASH Test 3-11 produced higher impact energy and resulted in a greater force applied to the barrier units and connections. The center of gravity (e.g.) of the pickup truck is higher than the center of gravity of the small car. As a result, vehicle stability is of greater concern for this barrier type for the pickup truck test. If vehicle stability and strength of the barrier system are acceptable for the pickup truck test, it is the assumption of TTI that these evaluation parameters will be acceptable for the small car test. The MASH small car presents a lower center of gravity and smaller impacting force on the barrier system. In addition, lateral deformations in the barrier system from the impacting vehicle and the forces in the anchoring hardware to the deck are expected to be greater for the pickup truck test.</p>	Non-Critical, not conducted
3-11 (2270P)	<p>TTI Test 690900-HS11, performed 2015-06-15, Test Report No. 690900-HS11: The Zoneguard" barrier pinned on both sides every 50-ft on 3-inch thick asphalt contained and redirected the 2270P vehicle. The vehicle did not penetrate, underride, or override the installation. Maximum dynamic deflection during the test was 38.9 inches at the toe of the barrier. No detached elements, fragments, or other 3-11 (2270P) debris were present to penetrate or show potential for penetrating the occupant compartment, or to present hazard to others in the area. No occupant compartment deformation or intrusion occurred. The 2270P vehicle remained upright during and after the collision event. Maximum roll and pitch angles were 46 degrees and 13 degrees, respectively. Occupant risk factors were within the preferred limits of MASH.</p>	PASS
3-20 (1100C)	This system is not a transition system.	Non-Relevant Test, not conducted
3-21 (2270P)	This system is not a transition system.	Non-Relevant Test, not conducted

Request for Federal Aid Reimbursement Eligibility of Highway Safety Hardware

Submitter	Date of Request:	March 17, 2016	<input checked="" type="radio"/> New <input type="radio"/> Resubmission
	Name:	Gary Lallo	
	Company:	Hill & Smith, Inc.	
	Address:	987 Buckeye Road, Columbus, OH 43207	
	Country:	United States	
	To:	Michael S. Griffith, Director FHWA, Office of Safety Technologies	

I request the following devices be considered eligible for reimbursement under the Federal-aid highway program.

Device & Testing Criterion - Enter from right to left starting with Test Level

!-!-!

System Type	Submission Type	Device Name / Variant	Testing Criterion	Test Level
'B': Rigid/Semi-Rigid Barriers (Roadside, Median, Bridge Railings)	<input checked="" type="radio"/> Physical Crash Testing <input type="radio"/> Engineering Analysis	Zoneguard, Asphalt	AASHTO MASH	TL3

By submitting this request for review and evaluation by the Federal Highway Administration, I certify that the product(s) was (were) tested in conformity with the AASHTO Manual for Assessing Safety Hardware and that the evaluation results meet the appropriate evaluation criteria in the MASH.

Individual or Organization responsible for the product:

Contact Name:	Gary Lallo	Same as Submitter <input checked="" type="checkbox"/>
Company Name:	Hill & Smith, Inc.	Same as Submitter <input checked="" type="checkbox"/>
Address:	987 Buckeye Road, Columbus, OH 43207	Same as Submitter <input checked="" type="checkbox"/>
Country:	United States	Same as Submitter <input checked="" type="checkbox"/>
Enter below all disclosures of financial interests as required by the FHWA 'Federal-Aid Reimbursement Eligibility Process for Safety Hardware Devices' document.		
TTI Proving Ground had/has no financial interests in the Hill & Smith Zoneguard barrier. Hill & Smith, Inc. contracted for the service of crash testing this barrier according to specifications for American Association of State Highway and Transportation Officials (AASHTO) Manual for Assessing Safety Hardware (MASH) Test 3-11, for which TTI Proving Ground was compensated for the cost to perform the test.		

PRODUCT DESCRIPTION

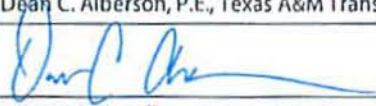
<input checked="" type="radio"/> New Hardware or Significant Modification	<input type="radio"/> Modification to Existing Hardware	
<p>For Minimum Deflection System (anchored at ends and intermediate) Zoneguard was tested to NCH RP Report 350 TL-3, TL-4 and MASH TL-3 in 2007 and received eligibility letters B-176 and B-176A in 2008. At the time two different anchoring configurations were tested. This request pertains to the configuration which is anchored at each end of the run and at intermediate locations along the length of the run and which we call "Minimum Deflection Anchoring Configuration". The original tests used to establish MASH eligibility were ZG-USA-1 and ZG-USA-3. Data summary sheets for both are attached. In these original tests the surface was concrete and adhesive anchors were used. The recent testing performed and submitted herein was on an asphalt surface. The significant revisions made were the removal of the rubber pads on the 33'-4" centers on the original test. The attached document describes some minor modifications made to the barrier. With this request we seek approval of the modified system without the rubber pads using the anchor pins on an asphalt surface with both 50'-0" and 33'-4" anchor spacing.</p>		
<h3>CRASH TESTING</h3>		
<p>By signature below, the Engineer affiliated with the testing laboratory, agrees in support of this submission that all of the critical and relevant crash tests for this device listed above were conducted to meet the MASH test criteria. The Engineer has determined that no other crash tests are necessary to determine the device meets the MASH criteria.</p>		
Engineer Name:	Dean C. Alberson, P.E., Texas A&M Transportation Institute	
Engineer Signature:		
Address:	3135 TAMU, College Station, TX 77843	Same as Submitter <input type="checkbox"/>
Country:	USA	Same as Submitter <input type="checkbox"/>

A brief description of each crash test and its result:

Full Scale Crash Testing was done in compliance with MASH by the following accredited crash test laboratory (cite the laboratory's accreditation status as noted in the crash test reports.):

Laboratory Name:	Texas Transportation Institute	
Laboratory Signature:		
Address:	3135 TAMU, College Station, TX 77843	Same as Submitter <input type="checkbox"/>
Country:	United States	Same as Submitter <input checked="" type="checkbox"/>
Accreditation Certificate Number and Dates of current Accreditation period :	A2LA Mechanical Testing Certificate 2821.01: 2015-02-19 through 2017-04-30	

Submitter Signature*: 

Submit Form

ATTACHMENTS

Attach to this form:

- 1) Additional disclosures of related financial interest as indicated above.
- 2) A copy of the full test report, video, and a Test Data Summary Sheet for each test conducted in support of this request.
- 3) A drawing or drawings of the device(s) that conform to the Task Force-13 Drawing Specifications [[Hardware Guide Drawing Standards](#)]. For proprietary products, a single isometric line drawing is usually acceptable to illustrate the product, with detailed specifications, intended use, and contact information provided on the reverse. Additional drawings (not in TF-13 format) showing details that are relevant to understanding the dimensions and performance of the device should also be submitted to facilitate our review.

FHWA Official Business Only:

Eligibility Letter		
Number	Date	Key Words

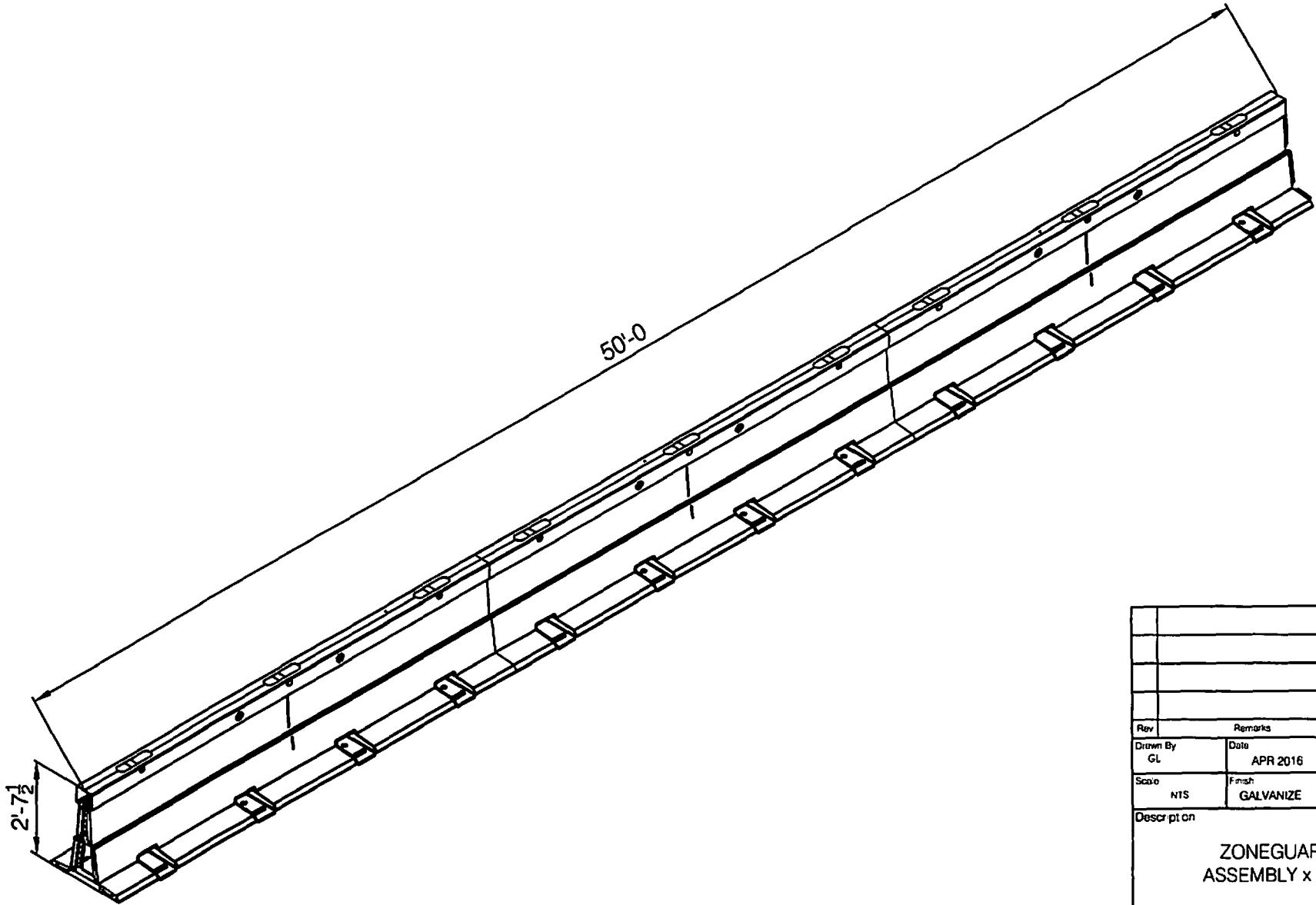

Rev	Remarks	ECR	Date	Check	
Drawn By GL	Date APR 2016	Material STEEL			
Scale N1S	Finish GALVANIZE	Weight			
Description ZONEGUARD ASSEMBLY x 50'-0					
UNCONTROLLED WHEN PRINTED					
hs		Hill & Smith <small>www.hillandsmith.com</small>			
Drawing No.		7000			

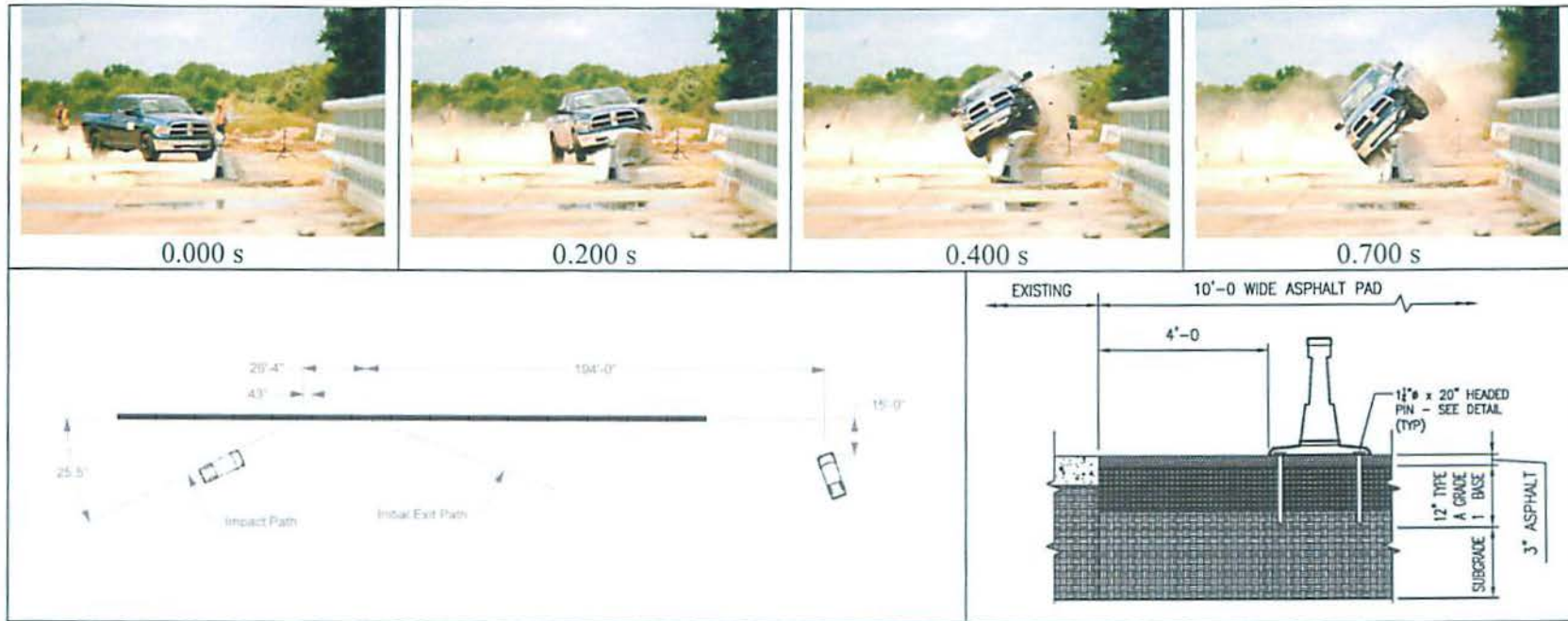

General Information

Test Agency..... Texas A&M Transportation Institute (TTI)
 Test Standard Test No. MASH Test 3-11
 TTI Test No. 690900-HS11
 Date 2015-06-15

Test Article

Type..... Portable Traffic Barrier
 Name Zoneguard® Barrier without Pads
 Installation Length 250 ft
 Material or Key Elements 50-ft galvanized steel barriers with drop-in pin anchors every 50 ft

Soil Type and Condition

3-inch thick asphalt, dry

Test Vehicle

Type/Designation..... 2270P
 Make and Model 2009 Dodge Ram 1500
 Curb 4947 lb
 Test Inertial 5015 lb
 Dummy No dummy
 Gross Static..... 5015 lb

Impact Conditions

Speed64.0 mi/h
 Angle25.5 degrees
 Location/Orientation43 inches upstrm of joint 5-6

Impact Severity

.....127 kip*ft (+10%)

Exit Conditions

Speed47.6 mi/h
 AngleNot obtainable

Occupant Risk Values

Longitudinal OIV13.1 ft/s
 Lateral OIV14.1 ft/s
 Longitudinal RDA.....4.5 G
 Lateral RDA5.6 G
 THIV20.1 km/h
 PHD6.6 G
 ASI0.88
 Max. 0.050-s Average
 Longitudinal-5.3 G
 Lateral6.2 G
 Vertical4.0 G

Post-Impact Trajectory

Stopping Distance 220 ft downstrm
 15 ft twd traffic

Vehicle Stability

Maximum Yaw Angle 263 degrees
 Maximum Pitch Angle..... 13 degrees
 Maximum Roll Angle..... 46 degrees
 Vehicle Snagging No
 Vehicle Pocketing No

Test Article Deflections

Dynamic (at the toe) 38.9 inches
 Permanent (at the toe) 22.0 inches
 Working Width (w/vehicle)..... 74.4 inches

Vehicle Damage

VDS 11LFQ4
 CDC 11FLEW4
 Max. Exterior Deformation..... 16.0 inches
 OCDI..... LF0000000
 Max. Occupant Compartment Deformation..... None

Figure 5.6. Summary of Results for MASH Test 3-11 on Zoneguard® Barrier Pinned on Both Sides Every 50-ft On-Center and Set on 3-inch Thick Asphalt.

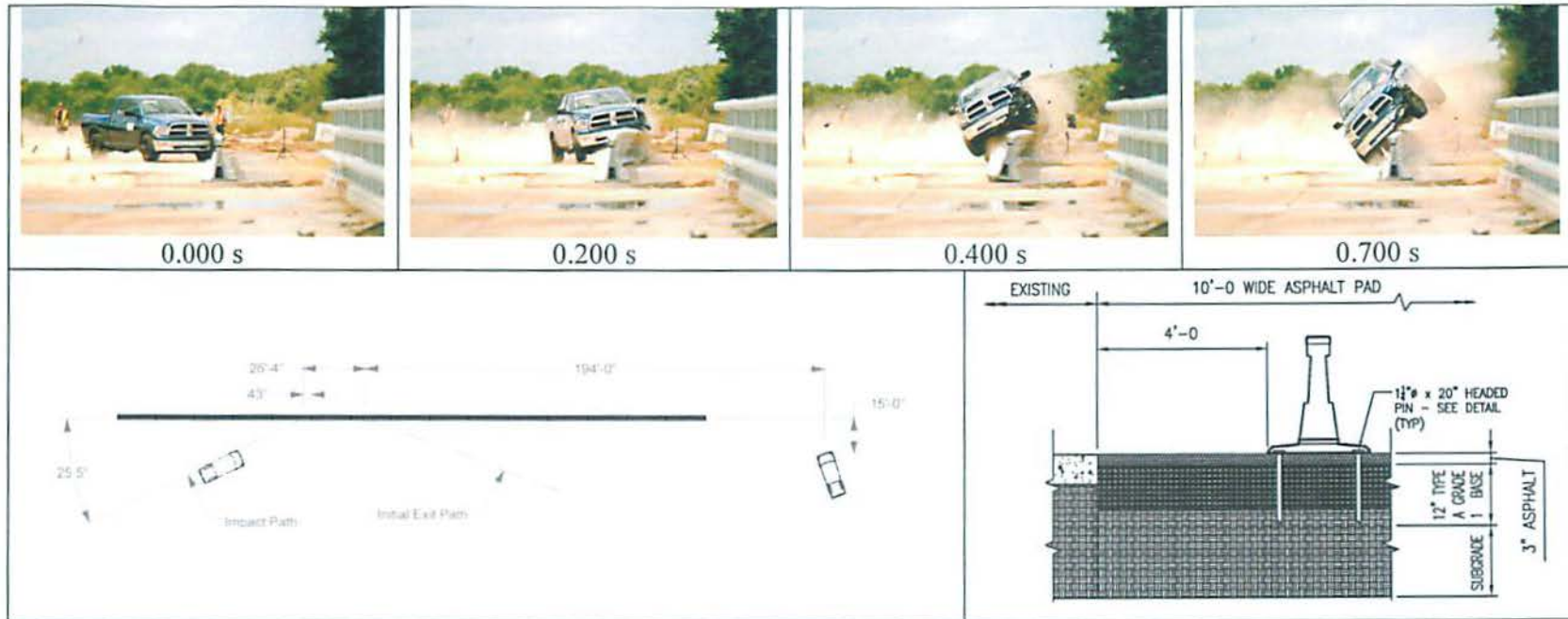

General Information

Test Agency..... Texas A&M Transportation Institute (TTI)
 Test Standard Test No. MASH Test 3-11
 TTI Test No. 690900-HS11
 Date 2015-06-15

Test Article

Type..... Portable Traffic Barrier
 Name Zoneguard® Barrier without Pads
 Installation Length 250 ft
 Material or Key Elements 50-ft galvanized steel barriers with drop-in pin anchors every 50 ft

Soil Type and Condition

..... 3-inch thick asphalt, dry

Test Vehicle

Type/Designation..... 2270P
 Make and Model 2009 Dodge Ram 1500
 Curb 4947 lb
 Test Inertial..... 5015 lb
 Dummy No dummy
 Gross Static..... 5015 lb

Impact Conditions

Speed64.0 mi/h
 Angle25.5 degrees
 Location/Orientation43 inches upstrm of joint 5-6

Impact Severity

.....127 kip*ft (+10%)

Exit Conditions

Speed47.6 mi/h
 AngleNot obtainable

Occupant Risk Values

Longitudinal OIV.....13.1 ft/s
 Lateral OIV14.1 ft/s
 Longitudinal RDA.....4.5 G
 Lateral RDA5.6 G
 THIV20.1 km/h
 PHD6.6 G
 ASI0.88
 Max. 0.050-s Average
 Longitudinal-5.3 G
 Lateral6.2 G
 Vertical4.0 G

Post-Impact Trajectory

Stopping Distance 220 ft downstrm
 15 ft twd traffic

Vehicle Stability

Maximum Yaw Angle.....263 degrees
 Maximum Pitch Angle..... 13 degrees
 Maximum Roll Angle.....46 degrees
 Vehicle Snagging No
 Vehicle Pocketing No

Test Article Deflections

Dynamic (at the toe) 38.9 inches
 Permanent (at the toe) 22.0 inches
 Working Width (w/vehicle)..... 74.4 inches

Vehicle Damage

VDS 11LFQ4
 CDC 11FLEW4
 Max. Exterior Deformation..... 16.0 inches
 OCDI..... LF0000000
 Max. Occupant Compartment Deformation..... None

Figure 5.6. Summary of Results for MASH Test 3-11 on Zoneguard® Barrier Pinned on Both Sides Every 50-ft On-Center and Set on 3-inch Thick Asphalt.

Table 4.1 – Summary of Test Results and Conditions

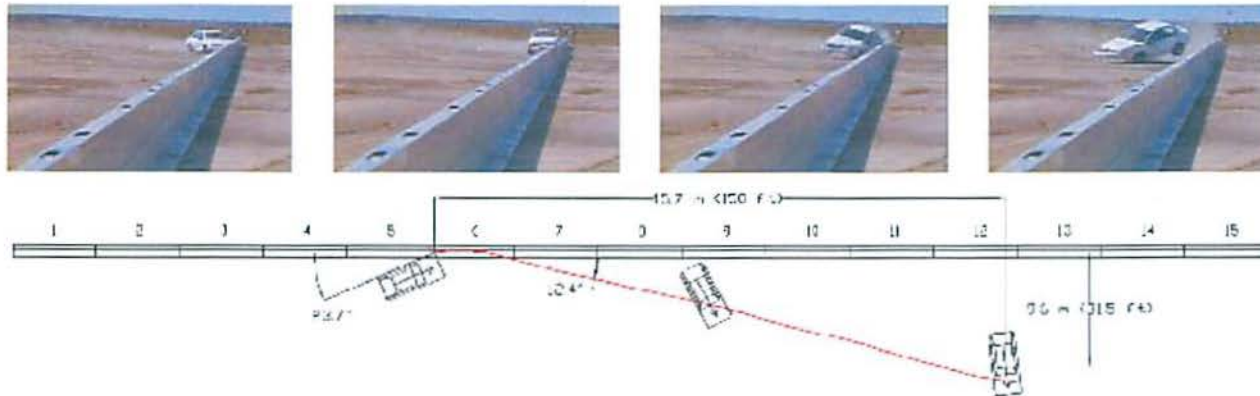

24 of 26

General Information

Test Agency Southwest Research Institute
 Test Number ZG-USA-1
 Test Date 10/01/2007
 Test Category 3-10 Update

Test Article

Type Longitudinal Barrier
 Installation Length 76.2 m (250 ft)
 Nom. Barrier Height 0.82 m (2.69 ft)
 Type of Primary Barrier Portable Steel Barrier

Soil

NA – Installed on Concrete

Test Vehicle

Type Small Car
 Designation 1100C
 Model 2002 Kia Rio
 Mass (kg) 1065
 Inertial Mass(kg) 1065
 Dummy Mass (kg) 73
 Gross Static Mass (kg) 1138

Impact Conditions

Speed (km/hr) 103.4
 Angle (degrees) 23.7

Exit Conditions

Speed (km/hr) 84 (calculated)
 Angle (degrees) 12

Occupant Risk Values

Impact Velocity (m/s)
 x-direction 5.0
 y-direction -7.2
 Ridedown Accelerations (g's)
 x-direction 3.3
 y-direction 12.8

Post Impact Vehicular Behavior

Maximum Roll Angle (degrees) -20.4 @ 0.420 sec.
 Maximum Pitch Angle (degrees) -9.9 @ 0.724 sec.
 Maximum Yaw Angle (degrees) 123.6 @ 2.767 sec.

Test Article Deflection

Dynamic (top of rail) 0.20 m (8 in)
 Dynamic (base of rail) 0.10 m (4 in)
 Permanent (top of rail) 0.09 m (3.5 in)
 Permanent (base of rail) 0 m (0 in)

Vehicle Damage

Exterior

CDC 11LFEW9
 VDS 11-LFQ-3

Interior

OCDI LF0000000
 Max. Deform. (mm) 0

Table 4.1 – Summary of Test Results and Conditions

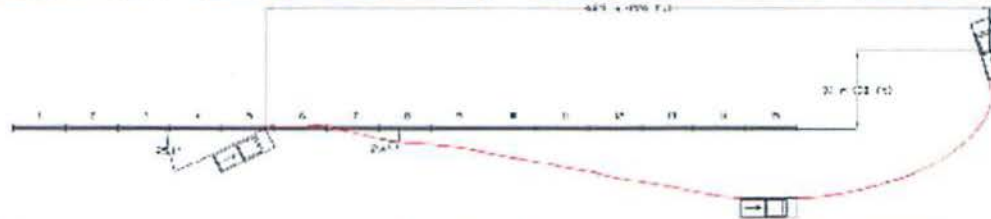

22 of 24

General Information

Test Agency Southwest Research Institute
 Test Number ZG-USA-3
 Test Date 10/02/2007
 Test Category 3-11 Update

Test Article

Type Longitudinal Barrier
 Installation Length 76.2 m (250 ft)
 Nom. Barrier Height 0.82 m (2.69 ft)
 Type of Primary Barrier .. Portable Steel Barrier

Soil

NA – Installed on Concrete

Test Vehicle

Type ¼-ton crew cab pickup
 Designation 2270P
 Model 2002 Dodge Ram 1500 Quad Cab
 Mass (kg) 2208
 Inertial Mass(kg) 2208
 Dummy Mass (kg) NA
 Gross Static Mass (kg) 2208

Impact Conditions

Speed (km/hr) 101.5
 Angle (degrees) 25.4

Exit Conditions

Speed (km/hr) 71 (calculated)
 Angle (degrees) 12.4

Occupant Risk Values

Impact Velocity (m/s)
 x-direction 4.5
 y-direction -5.6

Ridedown Accelerations (g's)

x-direction -8.3
 y-direction 14.1

Post Impact Vehicular Behavior (values limited to data < 1.000 seconds)

Maximum Roll Angle (degrees) -13.6 @ 0.539 sec.
 Maximum Pitch Angle (degrees) -14.6 @ 0.554 sec.
 Maximum Yaw Angle (degrees) 49.5 @ 1.000 sec.

Test Article Deflection

Dynamic (top of barrier) 0.41 m (16 in)
 Dynamic (base of barrier) 0.13 m (5 in)
 Permanent (top of barrier) 0.08 m (3 in)
 Permanent (base of barrier) 0 m (0 in)

Vehicle Damage

Exterior

CDC 11LFEW5
 VDS 11-LFQ-3

Interior

OCDI LF(0)(-1)(7)
 (- values = expansion of OC) (-4)(0)(0)(0)
 Max. Deform. (mm) 127