



U.S. Department  
of Transportation  
**Federal Highway  
Administration**

January 6, 2020

1200 New Jersey Ave., SE  
Washington, D.C. 20590

In Reply Refer To:  
HSST-1/WZ-386

Mr. Felipe Almanza  
TrafFix Devices Inc.  
160 Avenida La Pata  
San Clemente California 92673

Dear Mr. Almanza:

This letter is in response to your August 10, 2018 request for the Federal Highway Administration (FHWA) to review a roadside safety device, hardware, or system for eligibility for reimbursement under the Federal-aid highway program. This FHWA letter of eligibility is assigned FHWA control number WZ-386 and is valid until a subsequent letter is issued by FHWA that expressly references this device.

### **Decision**

The following device is eligible within the length-of-need, with details provided in the form which is attached as an integral part of this letter:

- TrafFix Water Wall LCD Water Wall Fence Panels

### **Scope of this Letter**

To be found eligible for Federal-aid funding, new roadside safety devices should meet the crash test and evaluation criteria contained in the American Association of State Highway and Transportation Officials' (AASHTO) Manual for Assessing Safety Hardware (MASH). However, the FHWA, the Department of Transportation, and the United States Government do not regulate the manufacture of roadside safety devices. Eligibility for reimbursement under the Federal-aid highway program does not establish approval, certification or endorsement of the device for any particular purpose or use.

This letter is not a determination by the FHWA, the Department of Transportation, or the United States Government that a vehicle crash involving the device will result in any particular outcome, nor is it a guarantee of the in-service performance of this device. Proper manufacturing, installation, and maintenance are required in order for this device to function as tested.

This finding of eligibility is limited to the crashworthiness of the system and does not cover other structural features, nor conformity with the Manual on Uniform Traffic Control Devices.

### **Eligibility for Reimbursement**

Based solely on a review of crash test results and certifications submitted by the manufacturer, and the crash test laboratory, FHWA agrees that the device described herein meets the crash test and evaluation criteria of the AASHTO's MASH. Therefore, the device is eligible for reimbursement under the Federal-aid highway program if installed under the range of tested conditions.

Name of system: Traffix Water Wall LCD Water Wall Fence Panels

Type of system: Work Zone

Test Level: MASH Test Level 2 (TL2)

Testing conducted by: KARCO

Date of request: February 21, 2019

FHWA concurs with the recommendation of the accredited crash testing laboratory per the attached form.

### **Full Description of the Eligible Device**

The device and supporting documentation, including reports of the crash tests or other testing done, videos of any crash testing, and/or drawings of the device, are described in the attached form.

### **Notice**

This eligibility letter is issued for the subject device as tested. Modifications made to the device are not covered by this letter. Any modifications to this device should be submitted to the user (i.e., state DOT) as per their requirements.

You are expected to supply potential users with sufficient information on design, installation and maintenance requirements to ensure proper performance.

You are expected to certify to potential users that the hardware furnished has the same chemistry, mechanical properties, and geometry as that submitted for review, and that it will meet the test and evaluation criteria of AASHTO's MASH.

Issuance of this letter does not convey property rights of any sort or any exclusive privilege. This letter is based on the premise that information and reports submitted by you are accurate and correct. We reserve the right to modify or revoke this letter if: (1) there are any inaccuracies in the information submitted in support of your request for this letter, (2) the qualification testing was flawed, (3) in-service performance or other information reveals safety problems, (4) the system is significantly different from the version that was crash tested, or (5) any other information indicates that the letter was issued in error or otherwise does not reflect full and complete information about the crashworthiness of the system.

### **Standard Provisions**

- To prevent misunderstanding by others, this letter of eligibility designated as FHWA control number WZ-386 shall not be reproduced except in full. This letter and the test documentation upon which it is based are public information. All such letters and documentation may be reviewed upon request.
- This letter shall not be construed as authorization or consent by the FHWA to use, manufacture, or sell any patented system for which the applicant is not the patent holder.
- This FHWA eligibility letter is not an expression of any Agency view, position, or determination of validity, scope, or ownership of any intellectual property rights to a specific device or design. Further, this letter does not impute any distribution or licensing rights to the requester. This FHWA eligibility letter determination is made based solely on the crash-testing information submitted by the requester. The FHWA reserves the right to review and revoke an earlier eligibility determination after receipt of subsequent information related to crash testing.

Sincerely,



Michael S. Griffith  
Director, Office of Safety Technologies  
Office of Safety

Enclosures

## Request for Federal Aid Reimbursement Eligibility of Highway Safety Hardware

<b>Submitter</b>	Date of Request:	8-10-18	<input checked="" type="radio"/> New <input type="radio"/> Resubmission
	Name:	Felipe Almanza	
	Company:	Traffix Devices Inc.	
	Address:	160 Avenida La Pata San Clemente California 92672	
	Country:	United States	
	To:	Michael S. Griffith, Director FHWA, Office of Safety Technologies	

I request the following devices be considered eligible for reimbursement under the Federal-aid highway program.

**Device & Testing Criterion** - Enter from right to left starting with Test Level

!-!-!

System Type	Submission Type	Device Name / Variant	Testing Criterion	Test Level
'WZ': Crash Worthy Work Zone Traffic Control Devices	<input checked="" type="radio"/> Physical Crash Testing <input type="radio"/> Engineering Analysis	Traffix Water Wall LCD W/Water Wall Fence Panels	AASHTO MASH	TL2

By submitting this request for review and evaluation by the Federal Highway Administration, I certify that the product(s) was (were) tested in conformity with the AASHTO Manual for Assessing Safety Hardware and that the evaluation results meet the appropriate evaluation criteria in the MASH.

**Individual or Organization responsible for the product:**

Contact Name:	Felipe Almanza	Same as Submitter <input checked="" type="checkbox"/>
Company Name:	Traffix Devices Inc.	Same as Submitter <input checked="" type="checkbox"/>
Address:	160 Avenida La Pata San Clemente California 92672	Same as Submitter <input checked="" type="checkbox"/>
Country:	United States	Same as Submitter <input checked="" type="checkbox"/>
Enter below all disclosures of financial interests as required by the FHWA 'Federal-Aid Reimbursement Eligibility Process for Safety Hardware Devices' document.		
Traffix Devices Inc. and Karco Engineering LLC share no financial interests between the two organizations. This includes no shared financial interest but not limited to: i. Compensation including wages, salaries, commissions, professional fees, or fees for business referrals iii. Research funding or other forms of research support; iv. Patents, copyrights, licenses, and other intellectual property interests; vi. Business ownership and investment interests;		

## PRODUCT DESCRIPTION

- New Hardware or Significant Modification
  Modification to Existing Hardware

The Traffix Water Wall with Fence Panels is a Longitudinal Channelizing Device (LCD) designed to provide a clear visual indication of the intended travel path through a construction work zone while providing demarked separation between the traveling public and pedestrians. The Traffix LCD with Fence Panels can be used in TL-1 and TL-2 applications. The LCD system is free standing, does not require anchoring to the road surface, can be used on concrete, asphalt gravel, and dirt surfaces. The surface used for these tests were concrete and dirt. The Traffix LCD can be used with or without the optional fence panels. For these tests the fence panels were included. An LCD system consists of individual water filled modules with fence panels that are connected to adjacent water filled modules and fence panels creating a continuous unobstructed longitudinal wall of unlimited maximum length. Adjoining modules can rotate up to 30 degrees between the connection with or without the fence panels installed, allowing the LCD wall to contour to varying road curvature.

Individual modules have overall dimensions of approximately 73 in (1.9 m) long, pin to pin X 18 in (0.46 m) wide X 32 in (0.8 m) tall with an empty module weighs approx. 75 lbs. (34 kg) and approx. 1,000 lbs. (454 kg) when filled with water. The modules are manufactured from polyethylene that is UV stabilized. The as tested module colors were orange and white in color and the modules may be produced in other colors. The modules are designed with four knuckles at each end which contains a series of vertically aligned concentric holes that allow a steel t-pin to be inserted to connect adjacent modules together. When modules are pinned together there are a total of eight knuckles aligned with the steel t-pin inserted. This provides a positive connection between adjacent modules.

The Traffix Water Wall LCD was previously tested, passed, and issued a FHWA Eligibility letter WZ-358. The LCD modules used in this recent test series are identical to the LCD modules tested under WZ-358.

The fencing panels were attached to the LCD Wall by inserting a 72.25 in (1.84 m) long drop t-pin through the sides of the fencing. The fence panels are approximately 74.50 in (1.90 m) wide X 51.75 in (1.31 m) tall.

The Traffix Water Wall LCD is not intended to function as a barrier, but instead it is designed and tested to provide a clear visual indication of the intended traveled path through a construction work zone.

### CRASH TESTING

By signature below, the Engineer affiliated with the testing laboratory, agrees in support of this submission that all of the critical and relevant crash tests for this device listed above were conducted to meet the MASH test criteria. The Engineer has determined that no other crash tests are necessary to determine the device meets the MASH criteria.

Engineer Name:	Alex Beltran	
Engineer Signature:		Digitally signed by Alex Beltran DN: cn=Alex Beltran, o=KARCO Engineering, ou=Testing Laboratory, email=abeltran@karco.com, c=US Date: 2018.08.14 08:17:47 -07'00'
Address:	9270 Holly Rd. Adelanto CA 92301	Same as Submitter <input type="checkbox"/>
Country:	United States	Same as Submitter <input type="checkbox"/>

A brief description of each crash test and its result:

Required Test Number	Narrative Description	Evaluation Results
2-90 (1100C)	<p>The Traffix Water Wall Longitudinal Channelizing Device (LCD) with Fence Panels was angled 25° from the direction of the impacting vehicle. The side impact examines the risk of vehicle rollover and/or excessive vehicle decelerations.</p> <p>The test was conducted using a commercially available 2015 Hyundai Accent 4-door sedan with a test inertial mass of 2,420.6 lbs. (1,098.0 kg). The test vehicle impacted the LCD at a velocity of 44.57 mph (71.73 km/hr) and at an impact angle of 25.4°. The as tested Traffix Water Wall LCD with Water Wall Fence Panels consisted of 25 water filled modules pinned together measuring 152.1 ft. (46.4 m) long, pin to pin.</p> <p>Upon initial contact with the first module the vehicle moved forward, impacted the adjacent module causing the module to rupture and disperse the contained water. The vehicle gated through the traffic side of the LCD and was brought to a controlled stop 40.8 ft. (12.4 m) longitudinally (downstream) and 34.3 ft. (10.5 m) toward the non-traffic side from the initial point of contact. The vehicle remained upright throughout the impact event. The test vehicle's occupant compartment was not penetrated and there was no measurable in cab deformation. The maximum roll and pitch angle did not exceed 75° and occupant risk values were within limits per MASH specifications for Occupant Impact Velocity (OIV) and Ridedown Acceleration (RA).</p>	PASS

Required Test Number	Narrative Description	Evaluation Results
2-91 (2270P)	<p>The Traffix Water Wall Longitudinal Channelizing Device (LCD) with Fence Panels was angled 25° from the direction of the impacting vehicle. The side impact examines the risk of vehicle rollover and/or excessive vehicle decelerations. The test was conducted using a commercially available 2012 RAM 1500 4-door pickup truck with a test inertial mass of 5,003.3 lbs. (2,269.5 kg). The test vehicle impacted the LCD at a velocity of 44.68 mph (71.91 km/hr) and at an impact angle of 25.2°. The as tested Traffix Water Wall LCD with Fencing consisted of 25 water filled modules pinned together measuring 152.1 ft. (46.4 m) long, pin to pin. Upon initial contact with the first module the vehicle moved forward, impacted the adjacent module causing the module to rupture and disperse the contained water. The vehicle gated through the traffic side of the LCD and was brought to a controlled stop 90.1 ft. (27.5 m) longitudinally (downstream) and 43.6 ft. (13.3 m) toward the non-traffic side from the initial point of contact. The vehicle remained upright throughout the impact event. The test vehicle's occupant compartment was not penetrated and there was no measurable in cab deformation. The maximum roll and pitch angle did not exceed 75° and occupant risk values were within limits per MASH specifications for Occupant Impact Velocity (OIV) and Ridedown Acceleration (RA).</p>	PASS

Full Scale Crash Testing was done in compliance with MASH by the following accredited crash test laboratory (cite the laboratory's accreditation status as noted in the crash test reports.):

Laboratory Name:	Applus IDIADA KARCO Engineering	
Laboratory Signature:		<small>Digitally signed by Alex Beltran  DN: cn=Alex Beltran, o=KARCO Engineering, ou=Testing Laboratory,  email=abeltran@karco.com, c=US  Date: 2018.08.14 08:24:02 -07'00'</small>
Address:	9270 Holly Rd. Adelanto, CA. 92301	Same as Submitter <input type="checkbox"/>
Country:	United States	Same as Submitter <input type="checkbox"/>
Accreditation Certificate Number and Dates of current Accreditation period :	TL-371, July 2018 - July 2019	

Submitter Signature\*: *Felipe Almanza*

Digitally signed by Felipe Almanza  
DN: cn=Felipe Almanza, o=Traffic Devices  
Inc., ou=Engineering,  
email=falmanza@traffixdevices.com, c=US  
Date: 2018.08.07 12:06:06 -0700

**Submit Form**

### ATTACHMENTS

Attach to this form:

- 1) Additional disclosures of related financial interest as indicated above.
- 2) A copy of the full test report, video, and a Test Data Summary Sheet for each test conducted in support of this request.
- 3) A drawing or drawings of the device(s) that conform to the Task Force-13 Drawing Specifications [[Hardware Guide Drawing Standards](#)]. For proprietary products, a single isometric line drawing is usually acceptable to illustrate the product, with detailed specifications, intended use, and contact information provided on the reverse. Additional drawings (not in TF-13 format) showing details that are relevant to understanding the dimensions and performance of the device should also be submitted to facilitate our review.

FHWA Official Business Only:

Eligibility Letter		
Number	Date	Key Words



## MASH Test 2-90 Summary



0.000 s

0.100 s

0.300 s

0.950 s

1.600 s

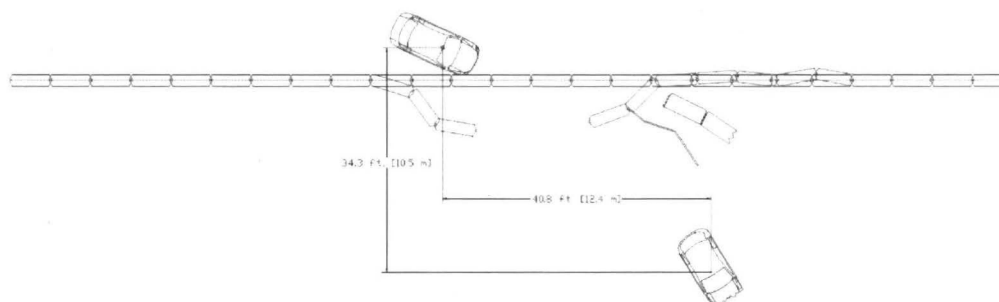

### General Information

Test Agency..... KARCO Engineering, LLC.  
 KARCO Test No..... P38103-01  
 Test Designation..... 2-90  
 Test Date..... 03/08/18

### Test Article

Name / Model..... LCD Water Wall w/ Fence Array  
 Type..... Longitudinal Chanelizer  
 Installation Length..... 152.1 ft. (46.4 m)  
 Module Length..... 73.0 in (1854 mm)  
 Road Surface..... Concrete and Soil

### Test Vehicle

Type / Designation..... 1100C  
 Year, Make, and Model..... 2015 Hyundai Accent  
 Curb Mass..... 2,468.0 lbs (1,119.5 kg)  
 Test Inertial Mass..... 2,420.6 lbs (1,098.0 kg)  
 Gross Static Mass..... 2,586.0 lbs (1,173.0 kg)

### Impact Conditions

Impact Velocity..... 44.57 mph (71.73 km/h)  
 Impact Angle..... 25.4°  
 Location / Orientation..... 3.8 ft. (1.8 m) upstream from  
 splice  
 Kinetic Energy..... 160.7 kip-ft (217.9 kJ)

### Exit Conditions

Exit Velocity..... 37.4°  
 Exit Angle..... 10.1 mph (16.3 km/h)  
 Final Vehicle Position..... 40.8 ft (12.4 m) downstream  
 34.3 ft. (10.5 m) field side  
 Vehicle Snagging..... None  
 Vehicle Pocketing..... Yes  
 Vehicle Stability..... Satisfactory  
 Maximum Roll Angle..... -3.7°  
 Maximum Pitch Angle..... 3.2°  
 Maximum Yaw Angle..... -8.3°

### Occupant Risk

Longitudinal OIV..... 24.0 ft/s (7.3 m/s)  
 Lateral OIV..... 4.6 ft/s (1.4 m/s)  
 Longitudinal RA..... -8.3 g  
 Lateral RA..... 3.4 g  
 THIV..... 24.0 ft/s (7.3 m/s)  
 PHD..... 8.6 g  
 ASI..... 0.62

### Test Article Deflections

Static..... 7.2 ft. (2.2 m)  
 Dynamic..... 7.2 ft. (2.2 m)  
 Working Width..... 13.9 ft. (4.2 m)

### Vehicle Damage

Vehicle Damage Scale..... 01-FR-2  
 CDC..... 01FREW1  
 Maximum Intrusion..... Negligible

Figure 2 Summary of Test 2-90

## MASH Test 2-91 Summary



0.000 s

0.100 s

0.300 s

0.950 s

0.950 s

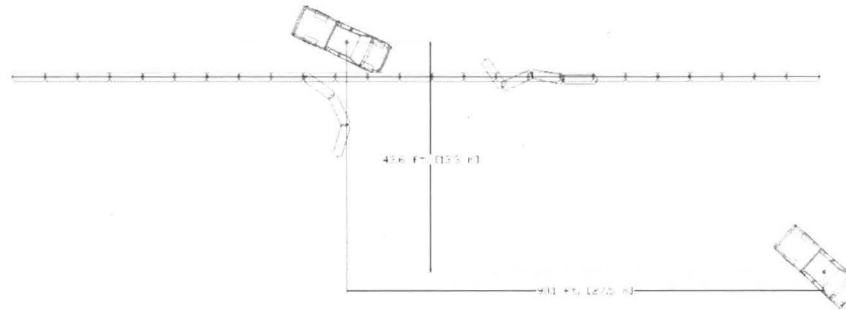

<b>General Information</b>	
Test Agency.....	KARCO Engineering, LLC.
KARCO Test No.....	P38065-01
Test Designation.....	2-91
Test Date.....	03/09/18
<b>Test Article</b>	
Name / Model.....	LCD Water Wall w/ Fence Array
Type.....	Longitudinal Channelizer
Installation Length.....	152.1 ft. (46.4 m)
Module Length.....	73.0 in (1854 mm)
Road Surface.....	Concrete and Soil
<b>Test Vehicle</b>	
Type / Designation.....	2270P
Year, Make, and Model.....	2012 RAM 1500
Curb Mass.....	5,033.1 lbs (2,283.0 kg)
Test Inertial Mass.....	5,003.3 lbs (2,269.5 kg)
Gross Static Mass.....	5,003.3 lbs (2,2269.5 kg)

<b>Impact Conditions</b>	
Impact Velocity.....	44.68 mph (71.91 km/h)
Impact Angle.....	25.2°
Location / Orientation.....	4.9 ft. (1.5 m) upstream from splice
Kinetic Energy.....	333.9 kip-ft (452.7 kJ)
<b>Exit Conditions</b>	
Exit Velocity.....	30.0°
Exit Angle.....	25.4 mph (40.9 km/h)
Final Vehicle Position.....	90.1 ft (27.5 m) downstream
	43.6 ft. (13.3 m) field side
Vehicle Snagging.....	None
Vehicle Pocketing.....	Yes
Vehicle Stability.....	Satisfactory
Maximum Roll Angle.....	-9.4°
Maximum Pitch Angle.....	10.3°
Maximum Yaw Angle.....	-5.4°

<b>Occupant Risk</b>	
Longitudinal OIV.....	18.0 ft/s (5.5 m/s)
Lateral OIV.....	0.0
Longitudinal RA.....	-3.3 g
Lateral RA.....	1.9 g
THIV.....	19.0 ft/s (5.8 m/s)
PHD.....	2.6 g
ASI.....	0.38
<b>Test Article Deflections</b>	
Static.....	15.8 ft. (4.8 m)
Dynamic.....	Obstructed View
Working Width.....	Obstructed View
<b>Vehicle Damage</b>	
Vehicle Damage Scale.....	01-FR-2
CDC.....	01FREW1
Maximum Intrusion.....*	Negligible

**Figure 2 Summary of Test 2-91**

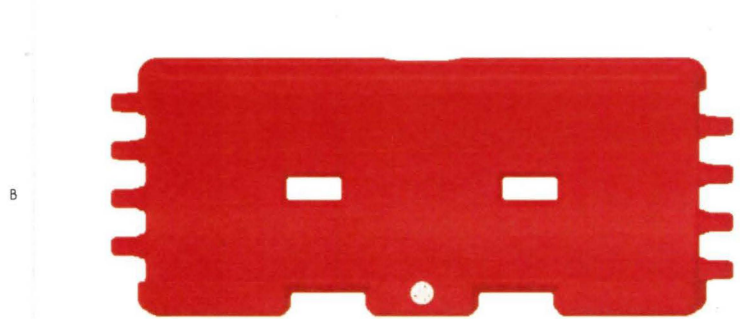
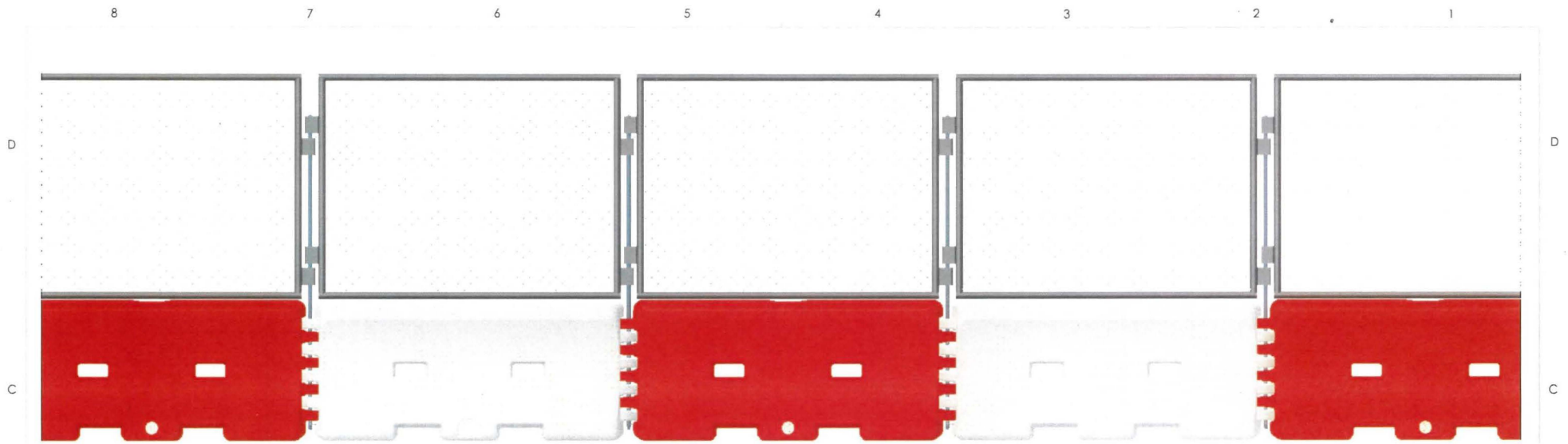

LCD Individual Module

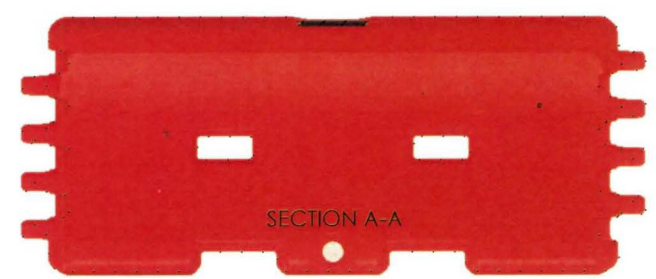

Section View of LCD Individual Module

NOTES: UNLESS OTHERWISE SPECIFIED

UNLESS OTHERWISE SPECIFIED:  
ALL DIMENSIONS ARE IN INCHES[mm].



160 Avenida La Pata  
San Clemente, CA 92673  
(949) 361-5663  
FAX (949) 361-9205  
www.traffixdevices.com

TITLE:  
**LCD Water Wall  
w/ Fence Array**

DRAWN BY: Christopher Jaime  
CHECKED BY: FA  
APPROVED BY: FA

DATE: 3/9/18  
DATE: 3/9/18  
DATE: 3/9/18

SIZE  
**B**

DWG. NO.  
**300-300**

REV  
**A**

SHEET 1 OF 1

8 7 6 5 4 3 2 1

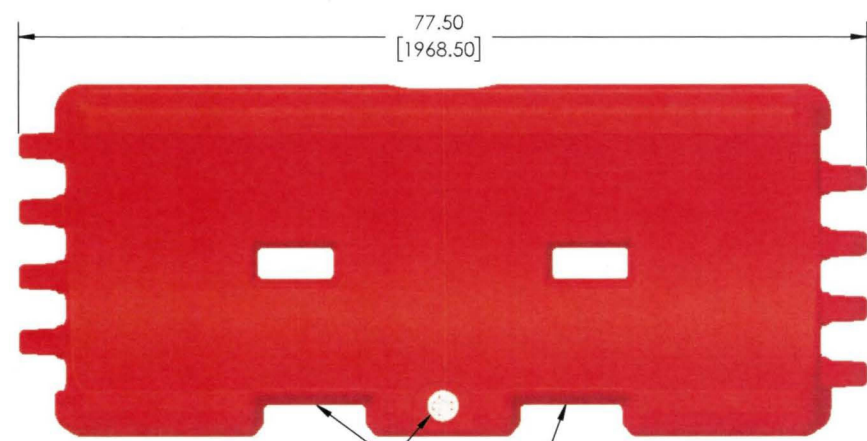
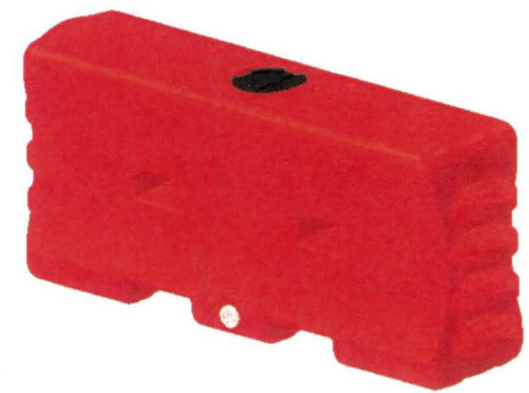
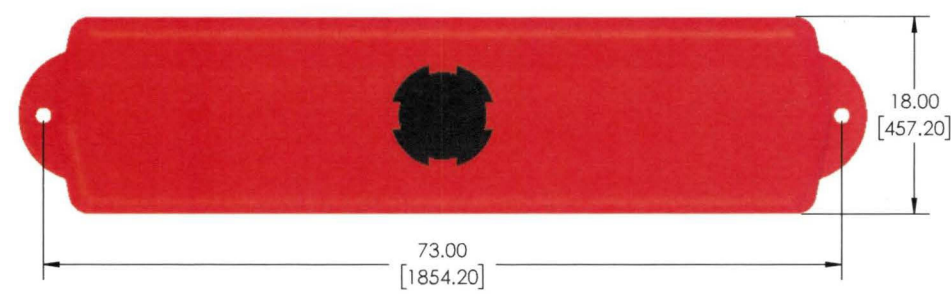

LCD Module  
 3. Color: Orange and White  
 2. Material: Plastic Polyethylene  
 1. Units: Inches [mm]  
**NOTES: UNLESS OTHERWISE SPECIFIED**

UNLESS OTHERWISE SPECIFIED:  
 ALL DIMENSIONS ARE IN INCHES[mm].  
 TOLERANCES:  
 DECIMAL: X.X ± .0425"  
 X.XX ± .032"

**TrafFix**  
**Devices Inc.**   
 160 Avenida La Pata  
 San Clemente, CA 92673  
 (949) 361-5663  
 FAX (949) 361-9205  
 www.traffixdevices.com

TITLE:  LCD Module		
SIZE <b>B</b>	DWG. NO. 300-301	REV <b>A</b>
DRAWN BY: Christopher Jaine		DATE: 3/9/18
CHECKED BY: FA		DATE: 3/9/18
APPROVED BY: FA		DATE: 3/9/18
		SHEET 1 OF 1

8 7 6 5 4 3 2 1

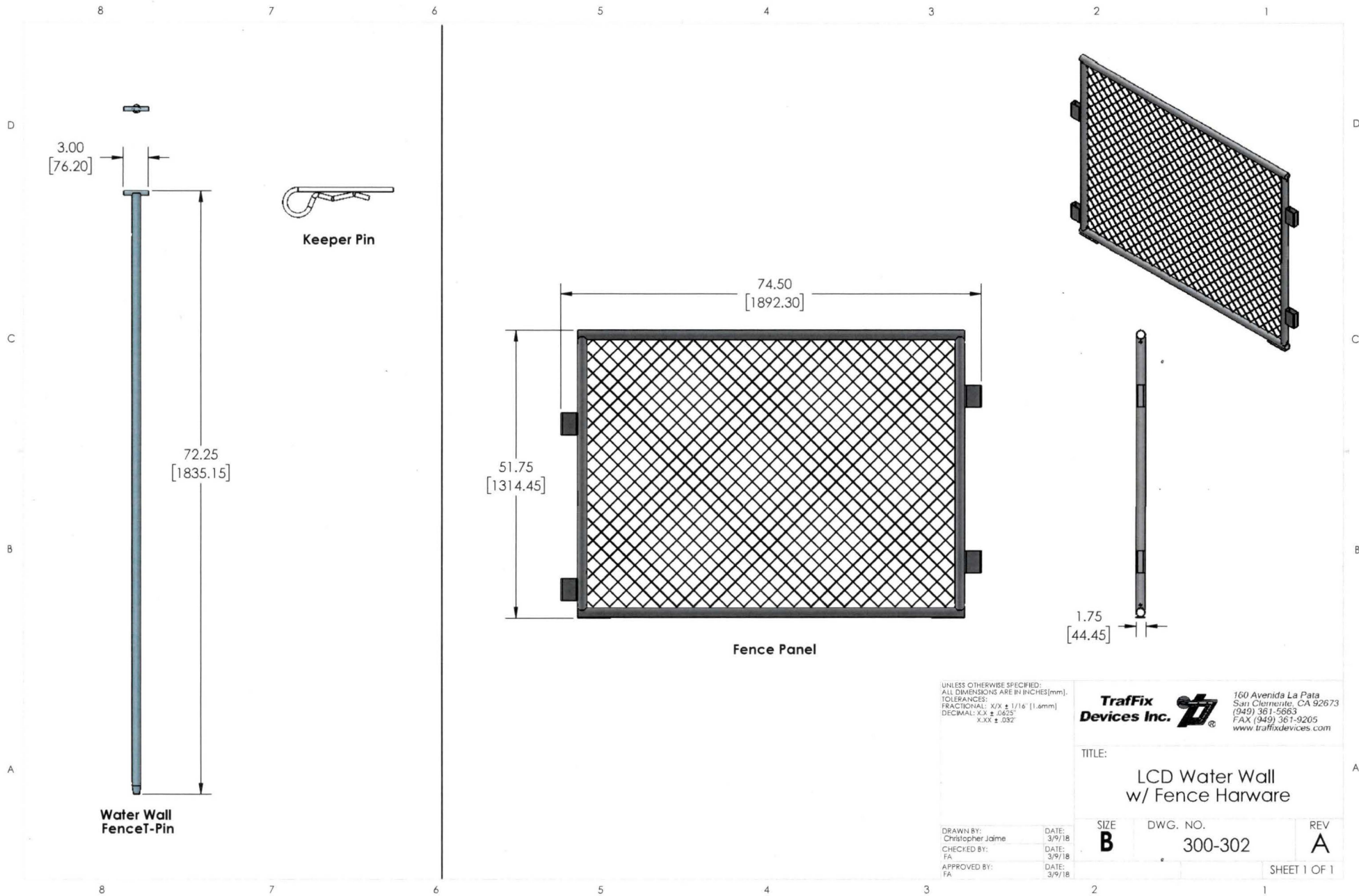

UNLESS OTHERWISE SPECIFIED:  
 ALL DIMENSIONS ARE IN INCHES (mm).  
 TOLERANCES:  
 FRACTIONAL: XX ± 1/16" [1.6mm]  
 DECIMAL: XX ± .0625"  
 XXX ± .032"



160 Avenida La Pata  
 San Clemente, CA 92673  
 (949) 361-5663  
 FAX (949) 361-9205  
 www.traffixdevices.com

TITLE:  
**LCD Water Wall  
 w/ Fence Hardware**

DRAWN BY: Christopher Jaime DATE: 3/9/18  
 CHECKED BY: FA DATE: 3/9/18  
 APPROVED BY: FA DATE: 3/9/18

SIZE <b>B</b>	DWG. NO. 300-302	REV <b>A</b>
------------------	---------------------	-----------------

SHEET 1 OF 1