



JUN 10 1992

U.S. Department
of Transportation

400 Seventh St., S.W.
Washington, D.C. 20590

**Federal Highway
Administration**

Refer to: HNG-14

Fouad H. Fouad, PhD., P.E.
Sherman International Corp.
Pole Division
2117 Magnolia Avenue So., Suite 103
Birmingham, Alabama 35205

Dear Dr. Fouad:

Thank you for your letter of April 24 to Mr. Thomas O. Willett requesting Federal Highway Administration's (FHWA) acceptance of your company's new line of breakaway fiberglass poles. You enclosed product specifications and a report, dated February 1992, of pendulum testing performed by the Southwest Research Institute (SWRI). In response to our requests, you sent additional material on the extrapolated high speed velocity change on May 21 and June 3.

One test was conducted to assess the compliance of the Sherman Catalog Number D-MB39-F-50-S10 direct burial fiberglass luminaire support with the breakaway requirements of the 1985 AASHTO Standard Specifications for Structural Supports for Highway Signs, Luminaires and Traffic Signals. These specifications have been adopted, with minor modifications, by the FHWA. The test article is described in the enclosed specifications and drawing, and is considered representative of the largest of the breakaway direct burial poles.

The new breakaway design is achieved by weakening various layers of the fiberglass mats as well as adding a bondbreaker between the layers during fabrication of the pole. The pole is also strengthened above and below the impact zone with additional glass reinforcement. This breakaway design will supersede Sherman's previous direct burial fiberglass poles which received FHWA acceptance via our letter of November 10, 1988. We understand the special designation "85BK" will be given to your company's new line of breakaway poles so that they may be easily differentiated from non-breakaway models.

The test results are summarized here:

Soil type	NCHRP 230 S-2 ("Weak") soil*
Pole Mass, Kg (lbs.)	112 (246.5)

Luminaire Mounting Height, m (ft.)	11.28 (37.0)
Mass of Pole, Mast Arm, and Luminaire <u>above</u> point of breakaway, kg (lbs.)	106.8 (235.0)**
Pendulum Mass, kg (lbs.)	818 (1,800)
Impact Speed, km/h (mph)	32.2 (20.0)
Velocity Change, m/s (fps)	2.04 (6.69)
Calculated High Speed Velocity Change, m/s (fps)	1.75 (5.73)
Stub Height mm (in.)	250 (9.8)***

*Testing in S-2 soil is considered a "worst case" for the device, thus testing in S-1 soil is not warranted.

**Mass of pole below point of breakaway is 35.7 kg (78.5 lbs.)

***The stub of the pole (which was pulled up out of the soil a few inches) was severely damaged and had lost its structural integrity. It did not snag, nor otherwise impede a car driven over it after the test.

These results meet the change in velocity and stub height requirements adopted by AASHTO and the FHWA. Therefore, your company's fiberglass pole described above is acceptable for use on Federal-aid highway projects, within the range of conditions tested, if proposed by a State. You also asked for our acceptance of several other poles which would be expected to perform at least equal to the tested pole with respect to vehicular impact. A listing of the catalog numbers and sizes of these poles are enclosed. We concur that these additional poles are also acceptable for use on Federal-aid highway projects as discussed above.

Our acceptance is limited to the breakaway characteristics of the system and does not cover its structural features. Presumably, you will supply potential users with sufficient information on structural design and installation requirements to ensure proper performance. We anticipate that the States will require certification from Sherman International Corp. that the poles furnished will meet the FHWA change in velocity requirements and have essentially the same composition, mechanical properties, and geometry as that used in the tested pole (with the understanding that the basic dimensions will differ for the additional poles accepted, as discussed above).

Sherman International Corp., fiberglass poles are proprietary. Thus, to be used in a Federal-aid highway project: (a) they must be supplied through competitive bidding with equally suitable unpatented items; (b) the State highway agency must certify that they are essential for synchronization with existing highway facilities or that no equally suitable alternate exists; or (c) they must be used for research or for a distinctive type of construction on relatively short sections of road for experimental purposes. Our regulations concerning proprietary products are contained in Title 23, Code of Federal Regulations, Section 635.411, a copy of which is enclosed.

Sincerely yours,

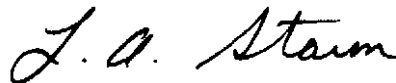
A handwritten signature in cursive script that reads "L. A. Staron".

Lawrence A. Staron
Chief, Federal-Aid and Design Division

Enclosures

Geometric and Roadside Design Acceptance Letter Number LS-26

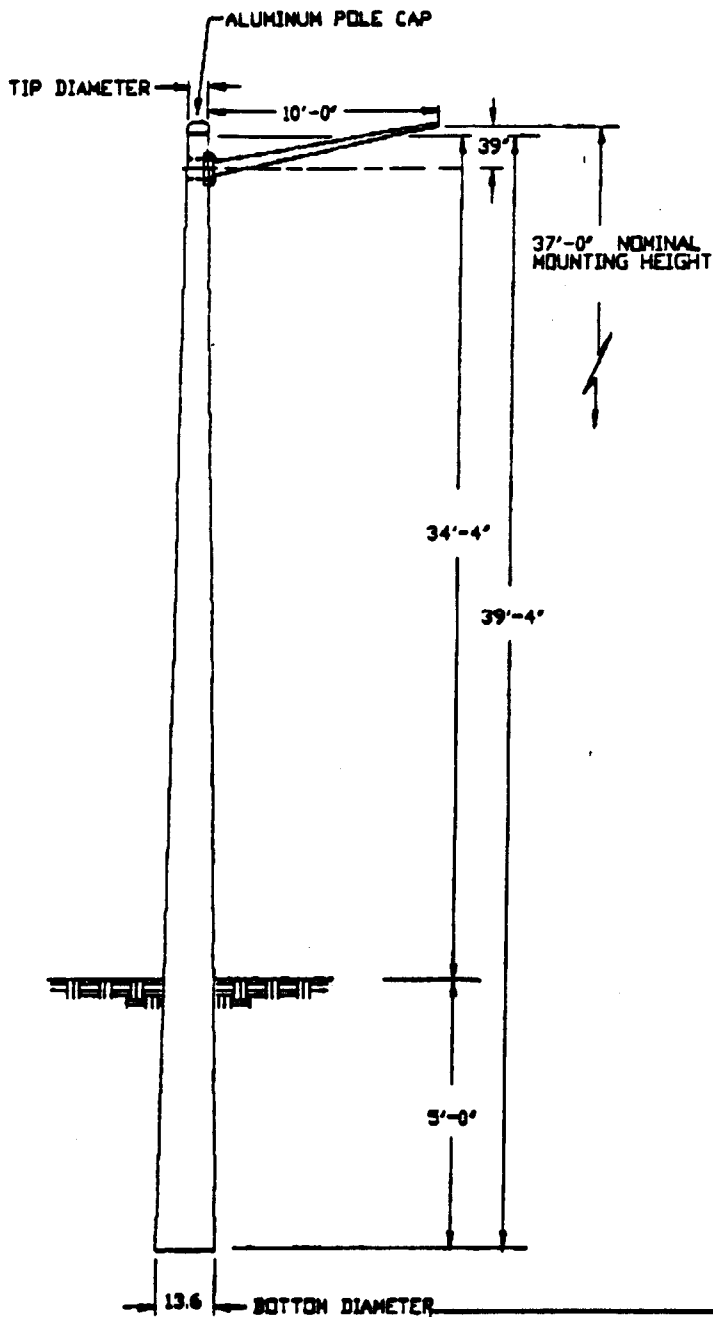

SOUTHWEST RESEARCH

CAT. NO. D-MB39-F-50-S10

SPECS	WIND VEL. 90 @ L3
TOT. LENGTH 39'-4"	LUM. WEIGHT 50 LBS
EMBED. DEPTH 5'-0"	LUM. EPA 2 SQ.FT
TIP DIA. 5.12	STATIC DEFL. 0.8%
WEIGHT 246 LBS	TOTAL DEFL. 7.8%
DRAWN BY MURPHY	DATE 1-07-92



SHERMAN
POLE DIVISION

Figure 2. Manufacturer's Drawing of Test Article

Poles Submitted for FHWA Breakaway Approval

Catalog Number	Nominal Mtg Ht (FT)	Shaft Length (FT)	Pole Wgt. (LB)	Tip O.D. (IN)	Butt O.D. (IN)	# Of Glass Layers	Area (in ²)
D-MB39-F-50-S10	3 7	39.37	246.50	15.2	13.63	4 + 1	9.38
TB16-B-40	14	16.48	30	3.0	6.58	1	1.88
TB20-B-40	16	19.75	45	3.0	7.27	2	3.75
TB24-B-40	20	24.00	60	3.0	8.18	2	3.75
TB13-B-50	10	13.17	24	3.0	5.84	1	1.88
TB20-B-50	16	19.75	53	3.0	7.27	2	3.75
TB24-B-50	20	24.00	67	3.0	8.18	2	3.75
TB30-C-50	25	29.58	92	3.7	10.09	3	5.63
TB35-C-50	30	35.00	119	3.7	11.26	3	5.63
TB40-C-50	35 I	39.37	147	3.7	12.22	3	6.63
TB20-D-100	16	19.75	53	4.41	8.68	2	3.75
TB24-D-100	20	24.00	67	4.41	9.59	2	3.75
TB30-D-100	25	29.58	97	4.41	10.80	3	5.63
TB35-D-100	30	35.00	122	4.41	11.97	3	5.63
TB40-D-100	35	39.37	153	4.41	12.93	4	7.50
TB24-D-200	20	24.00	88	4.41	9.59	3	5.63
TB30-D-200	25	29.58	106	4.41	10.80	3	5.63
TB35-D-200	30	35.00	147	4.41	11.97	4	7.50
TB40-D-200	35	39.37	170	4.41	12.93	4	7.50
TB35-F-300	30	35.00	160	5.12	12.68	4	7.50

Breakaway Pole tested by SWRI

Catalog Number	Nominal Mtg Ht (FT)	Shaft Length (FT)	Pole Wgt. (LB)	0% (IN)	Butt O.D. (IN)	# Of Glass Layers	Area (in ²)
SB13-C-50	10	13.17	24	a.7	6.53	1	1.33
SB20-C-50	16	19.76	62	3.7	7.97	2	3.76
SB24-C-50	20	24.99	66	3.7	0.33	2	3.75
SB30-C-50	25	29.58	96	3.7	10.09	3	5.63
SB35-C-50	30	35.00	121	3.7	11.26	3	5.63
SB40-C-50	35	39.37	150	3.7	12.22	3	5.63
SB46-C-50	40	45.93	203	3.7	13.63	4	7.50
SB30-D-100	25	29.53	104	4.41	10.80	3	5.63
SB35-D-100	30	35.00	129	4.41	11.97	3	5.63
SB20-D-110	16	19.75	56	4.41	8.68	2	3.75
SB24-D-110	20	24.00	80	4.41	9.59	3	5.63
SB30-D-110	25	29.53	107	4.41	10.80	3	5.63
SB35-D-110	30	35.00	145	4.41	11.97	4	7.50
SB40-D-110	35	39.37	173	4.41	12.91	4	7.50
MB23-D-50-S4	20	23.00	63	4.41	9.38	2	3.75
MB30-D-50-S4	25	29.53	95	4.41	10.39	3	6.63
MB35-D-50-S4	30	34.69	123	4.41	11.86	3	6.63
MB39-F-50-S4	35	39.37	167	5.12	13.63	4	7.69

Catalog Number	Nominal Mtg Ht (FT)	Shaft Length (FT)	Pole Wgt. (LB)	Tip O.D. (IN)	Butt O.D. (IN)	# Of Glass Layers	Area (in ²)
MB23-D-50-D4	20	23.00	85	4.41	9.38	3	5.63
MB30-F-50-D4	25	29.53	117	5.12	11.51	3	5.63
MB35-G-50-D4	30	34. m	158	5.83	13.28	4	7.50
MB39-G-50-D4	35	39.39	185	5.83	14.34	4	7.50
MB23-D-50-S6	20	23.00	87	4.41	9.38	3	5.63
MB30-F-50-S6	26	29.56	115	5.12	11.51	3	5.53
MB33-F-50-S6	30	32.88	136	5.12	12.21	4	7. m
MB39-F-50-S6	36	se.42	178	5.12	13.63	4	7.50
MB23-F-50-D6	20	23.00	96	5.12	10.09	3	5.63
MB30-G-50-D6	26	29.53	141	5.83	12.22	4	7. m
MB33-G-50-D6	30	32.83	161	5.83	12.92	4	7. m
MB22-G-50-S8	20	22.00	90	5.83	10.58	3	5.63
MB28-K-50-S8	25	28.00	123	6.54	12.59	3	5.63
MB33-K-50-S8	30	32.8	161	6.54	13.63	4	7.50
MB22-K-50-D8	20	22.00	100	6.54	11.29	3	5.63
MB28-K-50-D8	25	28.00	144	6.54	12.59	4	7.50
MB22-K-50-S10	20	21.50	92	6.54	11.18	3	5.63
MB28-K-50-S10	25	27. m	121	6.54	12.48	3	5.63
MB33-K-50-S10	30	32.80	152	6.54	13.52	4	7. m

Catalog Number	Nominal Mtg Ht (FT)	Shaft Length (FT)	Pole Wgt. (LB)	Tip O.D. (IN)	Butt O.D. (IN)	# Of Glass Layers	Area (in ²)
MB22-K-50-D10	20	21.50	115	a54	11.18	3	5.63
MB21-K-50-S12	20	20.75	88	a54	11.02	8	5.63
MB28-K-50-S12	25	26.25	121	a54	12.21	a	5.63
MB32-K-50-S12	30	31.75	170	a54	13.40	4	7.50
MB36-K-50-S.2	35	36.09	201	a54	14.34	4	7.50
MB21-K-50-D12	20	20.75	117	6.54	11.02	4	7.50
EB23-C-50-SE4	20	22.97	80	3.70	8.66	2	3.75
EB30-D-50-SE4	25	29.53	111	4.41	10.79	3	5.63
EB35-D-50-SE4	30	34.75	137	4.41	11.92	3	5.63
EB40-D-50-SE4	35	45.75	168	4.41	13.00	4	7.50
EB46-D-50-SE4	40	45.75	203	4.41	14.29	4	7.50
EB23-C-50-DE4	20	22.97	89	3.70	am	3	I 5.55
EB30-D-50-DE4	25	29.53	131	4.41	10.79	4	7. m
EB33-D-50-DE4	30	34.00	158	4.41	11.75	4	7. m
D-MB34-F-75-S6	30	33.50	189	5.12	12.36	4	7. m

D-TB35-D-252	30	35	164	4.41	12.0	4	7.50
D-TB30-D-252	25	29.58	124	4.41	10.3	3	6.63
D-TB24-D-252	20	24	91	4.41	9.6	3	5.63
D-TB40-D-186	35	39.37	170	4.41	12.9	4	7.50
D-TB35-D-186	30	35	131	4.41	12.0	4	5.63
D-TB30-D-186	25	29.58	103	4.41	10.8	3	5.63
D-TB24-C-123 D-TB40-C-123	20 40	24 45.92	84 197	3.7	8.9 13.6	3 4	5.63 7.50
D-TB40-C-123	35	39.37	156	3.7	12.2	4	7.50
D-TB35-C-123	30	35	117	3.7	11.3	3	5.63
D-TB30-C-123	25	29.58	97	3.7	10.1	3	5.63
D-TB24-C-123	20	24	66	3.7	8.9	2	3.75
D-TB40-C-50 D-TB35-C-50	40 30	45.92 35	170 108	3.7 3.7	13.6 11.3	4 3	7.50 5.63
D-TB40-C-50 D-TB30-C-50	35 25	39.37 29.58	134 77	3.7 3.7	12.2 10.1	3 2	5.63 3.75
D-TB24-C-50	20	24	58	3.7	8.9	2	3.75
D-MB33-D-50-S6	30	32.33	141	4.41	11.49	3	6.33
D-TB20-B-35	16	19.76	40	3.0	1.3	2	3.76
	Mtg.Ht (FT)	Length (FT)	Wgt. (LB)	O.D. (IN)	O.D. (IN)	Glass Layers	(in ²)
Catalog Number	Nominal	Shaft	Pole	Tip	Butt	# of	Area

D-MB40-D-90-D6	34.83	39.42	232	4.41	12.92	4	7.50
D-MB35-D-90-D6	31.42	36.0	160	5.12	12.70	4	7.50
D-MB30-D-90-D6	26.0	29.58	118	5.12	11.60	3	5.63
D-MB24-D-90-D6	21.42	24.0	100	4.41	9.60	3	5.63
D-MB40-D-45-S6 D-MB34-D-45-S6	30.42 30.42	34.50 34.50	133 133	4.41	11.90	3	5.63
D-MB28-C-45-S6	24.33	27.92	94	3.70	9.70	3	5.62
D-MB40-F-50-S6/D6	35.83	39.42	136	5.12	12.70	4	7.60
D-MB35-F-50-S6/D6	31.42	36.0	160	5.12	12.70	4	7.50
D-MB30-F-50-S6/D6	26.0	29.58	118	5.12	11.60	3	5.63
D-MB24-F-50-S6/D6 D-SB46-C-50	30.92 30.92	45.92 45.92	218 218	4.41 3.70	13.60 13.60	4 4	7.50 7.50
D-SB40-D-50	34.42	39.42	153	4.41	12.0	4	7.50
D-SB35-D-50	30.0	35.0	126	4.41	10.8	3	5.63
D-SB30-D-50	24.58	29.58	105	4.41	10.8	3	5.63
D-SB24-C-50	20.0	24.0	76	3.79	3.9	2 Layers	3.75
Catalog Number	Nominal Mtg.Ht (FT)	Shaft Length (FT)	Pole Wgt. (LB)	Tip O.D. (IN)	Butt O.D. (IN)	# of Glass Layers	Area (in ²)
Catalog Number	Nominal	Shaft	Pole	Tip	Butt	# of	Area

TECHNICAL INFORMATION
SPUN FIBERGLASS REINFORCED PLASTIC POLES

I MATERIALS

The two main components used in the manufacturing of the spun FRP pole are the polyester resin and the fiberglass fabric reinforcement. In addition a non-structural surfacing veil (mat) is used to **provide protection** to the surface of the pole. The **type, trade name, and** some of the physical characteristics of the basic materials used are given herein:

(A) Polyester Resin

Type: Unsaturated polyester resin solution
Manufacturer: GLS Fiberglass
~~Trade Name:~~ **GLS 1002-MJC**
Viscosity: #3 60 rpm; 400-500 cps
Unit Weight: 9.1 lbs/gallon specific gravity = 1.10
Vapor Density: Heavier than air
Evaporation Rate: Slower than ether
Boiling Range: 290-295 °F
Percentage Volatile by Volume: 47.4%
Flashpoint: **90°F**; LEL = 1.1%
Gel Time: (mm:ss) = 16:00
Cure Time: (mm:ss) = 27:00
Peak Exotherm = 357 °F

(B) Glass Fabric

Type: "E" glass (electrical grade); unidirectional roving
Manufacturer & Class: Syncoglas V672 or Syncoglas 42RK/M300
Weight: 29 oz./sq.yd.
Specific Gravity: = 2.54
Thickness: =.05 in./layer

(C) Surfacing Veil

Type: Polyester mat.
Manufacturer & Class: Royalin Gmbh, G6/11.40A/00/50
Weight: 1.5 oz./sq.yd.
Thickness: .019 in./layer

RAW MATERIALS

GLASS

20 **oz/sq** YD LONGITUINALLY
ORIENTED
(70%)

* WGT - 28 OZ/SQ YD

8 **oz/sq** YD. *CHOPPED* STRAND
MECHANICALLY
BONDED (30%)

* THICK - 50 MILS

VEIL

* WGT ~ 1.50 **oz/sq** YD

* THICK ~ 19 **MILS**

RESIN

* **SPECIFIC GRAVITY** = 1.10 (68.6 LB/ CU.FT,
9.2 LB/GALLON)

* **SATURATION RATIO**

FOR GLASS 60% RESIN
40% GLASS BY WEIGHT

FOR VEIL 90% RESIN
10% POLYESTER BY WEIGHT

SURFACING MAT (VEIL)

- IS A LIGHTWEIGHT MAT (~1.5 OZ./SQ.YD.)
- USED AS RESIN-RICH SURFACE LAYER
- TO PROVIDE GOOD APPEARANCE, SMOOTH SURFACE
- FOR RESISTANCE TO WEATHERING
- PREVENTS UNDERLYING GLASS FIBERS FROM PROTRUDING THRU THE SURFACE
- PROVIDES A CHEMICAL RESISTANT COVERING
- COMPENSATES FOR SHRINKAGE THAT MIGHT OTHERWISE OCCUR IN A RESIN-RICH SURFACE
- TYPE USED:
STANDARD SURFACING VEIL MADE OF POLYESTER MATERIAL.
- THE VEIL IS HIGH IN RESIN (MIN 90% BY WGT) THAT CONTAINS UV-INHIBITORS AND PIGMENT THAT MAKES IT UV-RESISTANT, AND ASSURES LONG LIFE WITHOUT CLASS 1 BLOWING"

II MECHANICAL PROPERTIES

Listed below are **typical physical and mechanical properties** of the composite FRP laminate used in pole construction. The properties are based on a laminate that is composed of **40%** glass and **60%** polyester resin.

Specific Gravity:	1.7
Tensile Strength (psi)	36,000
Compressive Strength (psi)	30,000
Flexural strength (psi)	35,000
Shear strength (psi)	6,000
Elastic Modulus (psi)	2,700,000
Poisson's Ratio	0.16

Our manufacturing process may be summarized as follows:

- 1) A predetermined number of glass fabric layers and a surfacing veil are placed in a hollow steel mold.
- 2) The mold is rotated slowly so the materials will unwind and conform smoothly to the wall of the mold.
- 3) The mold is then rotated at a high speed (1200-1500 rpm) during which the polyester resin and special catalyst are injected into the mold.
- 4) During spinning the resin is being cured using radiant heaters which keep the mold at an elevated temperature.
- 9) After the laminate achieves complete saturation the speed of the mold is reduced while the **resin** still continues to cure.
- 6) The finished pole shaft is removed from the mold after completion of curing.
- 7) The shaft is then trimmed and subjected to the special fabrication operations as required per shop drawings.

..
Notes on Pole Manufacturing

- 1) ~~The resin/glass~~ fiber ratio (by weight) **for the** main reinforcing glass fabric is approximately 0.60.
- 2) The resin/glass fiber ratio for the surfacing veil is approximately 0.90.
- 3) The resin gel time varies between 15 to 20 minutes.
- 4) The gel time is established and varied by **controlling** the dosage of **MEKP** (peroxide catalyst)
- 9) The curing period is approximately as long as the gel time.

tinctive type of construction on relatively short sections of road for experimental purposes.

(b) When there is available for purchase more than one nonpatented, nonproprietary material, semifinished or finished article or product that will fulfill the requirements for an item of work of a project and these available materials or products are judged to be of satisfactory quality and equally acceptable on the basis of engineering analysis and the anticipated prices for the related item(s) of work are estimated to be approximately the same, the PS&E for the project shall either contain or include by reference the specifications for each such material or product that is considered acceptable for incorporation in the work. If the State highway agency wishes to substitute some other acceptable material or product for the material or product designated by the successful bidder or bid as the lowest alternate, and such substitution results in an increase in costs, there will not be Federal-aid participation in any increase in Costa.

(c) A State highway agency may require a specific material or product when there are other acceptable materials and products, when such specific choice is approved by the Division Administrator as being in the public interest. When the Division Administrator's approval is not obtained, the item will be nonparticipating unless bidding Procedures are used that establish the unit price of each acceptable alternative. In this case Federal-aid participation will be based on the lowest price so established.

(d) Appendix A sets forth the FHWA requirements regarding (1) the specification of alternative types of culvert pipes, and (2) the number and types of such alternatives which must be set forth in the specifications for various types of drainage installations.

(e) Reference in specifications and on plans to single trade name materials will not be approved on Federal-aid contracts.

§ 636.411 Material or product selection.

(a) Federal funds shall not participate, directly or indirectly, in payment for any premium or royalty on any patented or proprietary material, specification, or process specifically set forth in the plans and specifications for a project, unless:

(1) Such patented or proprietary item is purchased or obtained through competitive bidding with equally suitable unpatented items; or

(2) The State highway agency certifies either that such patented or proprietary item is essential for synchronization with existing highway facilities, or that no equally suitable alternate exists; or

(3) Such patented or proprietary item is used for research or for a dis-



U.S. Department
of Transportation

Federal Highway
Administration

FEB 15 1996

400 Seventh St., S.W.
Washington, D.C. 20590

Refer to: HNG-14

Fouad H. Fouad, Ph.D., P.E.
Professor of Civil Engineering
Sherman Utility Structures, Inc
P.O. Box 1926
Birmingham, Alabama 35201

Dear Mr. Fouad:

This is in response to your letter of January 7 to Mr. Gerald L. Eller requesting that the Federal Highway Administration find an additional number of your company's breakaway fiberglass luminaire supports acceptable for use on the National Highway System (NHS). On June 10, 1992, we wrote to you and found a range of poles acceptable based upon pendulum testing. The breakaway performance of these poles is achieved by weakening various layers of the fiberglass mats near the groundline as well as adding a bondbreaker between the layers during fabrication of the pole. The pole is also strengthened above and below the impact zone with additional glass reinforcement. Your current request is to add new poles to the catalog of poles we found acceptable in 1992. All of the new poles on your list are within the range of poles we have already found acceptable. Details of the pole construction may be found in the enclosed drawing and specifications.

The following additional poles are acceptable for use on the NHS, if requested by a State.

Catalog #	Mtg. Ht. mm (ft)	Shaft L. mm (ft)	Pole Mass kg (lbs)	Tip OD mm (in)	Butt OD mm (in)	# of Glass Layers	x-sect Area mm ² (in ²)
D-MB26-K-50-S12	6 400 (21)	8 004 (26.25)	54 9 (121)	166 (6.54)	310 (12.21)	3	3 632 (5.63)
D-MB32-K-50-S12	8 200 (27)	9 677 (31.75)	69 9 (154)	166 (6.54)	340 (13.4)	4	4 839 (7.5)
D-MB30-F-50-S6	7 600 (25)	9 016 (29.58)	49 9 (110)	130 (5.12)	292 (11.51)	3	3 632 (5.63)
D-MB33-F-50-S6	8 500 (28)	10 007 (32.83)	56 7 (125)	130 (5.12)	310 (12.21)	3	3 632 (5.63)
D-MB34-F-50-S6	8 800 (29)	10 211 (33.5)	59 0 (130)	130 (5.12)	314 (12.36)	3	3 632 (5.63)
MB36-K-50-S12	9 400 (31)	11 025 (36.17)	85 3 (188)	166 (6.54)	364 (14.35)	5	6 052 (9.38)
MB39-F-50-S6	10 700 (35)	12 015 (39.42)	78 5 (173)	130 (5.12)	348 (13.63)	4	4 839 (7.5)
MB40-F-50-S6	10 700 (35)	12 015 (39.42)	78 5 (173)	130 (5.12)	348 (13.63)	4	4 839 (7.5)
D-MB30-F-50-D6	7 600 (25)	9 016 (29.58)	63.5 (140)	130 (5.12)	292 (11.51)	4	4 839 (7.5)
NA30-S12-99	9 100 (30)	9 677 (31.75)	69 9 (154)	166 (6.54)	344 (13.54)	4	4 839 (7.5)
NA30-S12-02	9 100 (30)	9 677 (31.75)	69 9 (154)	166 (6.54)	344 (13.54)	4	4 839 (7.5)
The pole that was tested in 1992 to qualify the range of poles found acceptable by our June 10, 1992, memo was:							
D-MB39-F-50-S10	11 300 (37)	11 990 (39.33)	111 8 (246.5)	130 (5.12)	415 (13.63)	5	6 052 (9.38)

All conditions in our June 10, 1992, letter remain in effect.

Sincerely yours,

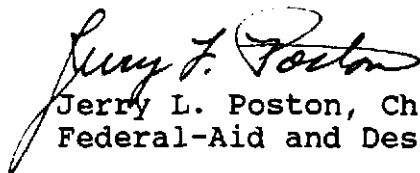
A handwritten signature in cursive script, reading "Jerry L. Poston". The signature is written in black ink and is positioned above the typed name and title.

Jerry L. Poston, Chief
Federal-Aid and Design Division

2 Enclosure

Geometric and Roadside Design Acceptance Letter LS-26A

Features of the breakaway device

Perfect sheaf of the pole upon impact was achieved through introducing the following modifications to the conventional pole design.

1. Cutting each glass laminate in the vicinity of the groundline. However not all glass layers are cut at the same section. Cuts are staggered approximately 4 inches apart.
2. Placing a layer of polyethylene foil (approx. 40" wide x 17" long) between the glass layers in the vicinity of the impact zone. The foil has holes cut in approximately 50% of its area to allow the passage of the resin during spinning of the pole. The objective of the polyethylene foil is to delaminate the pole in the impact zone, thus decreasing its shearing and flexural resistances considerably in that zone.
3. Providing additional glass reinforcement above and below the impact zone. This aids in confining the impact effect to the weakened zone and prevents failure from spreading to other regions of the pole.

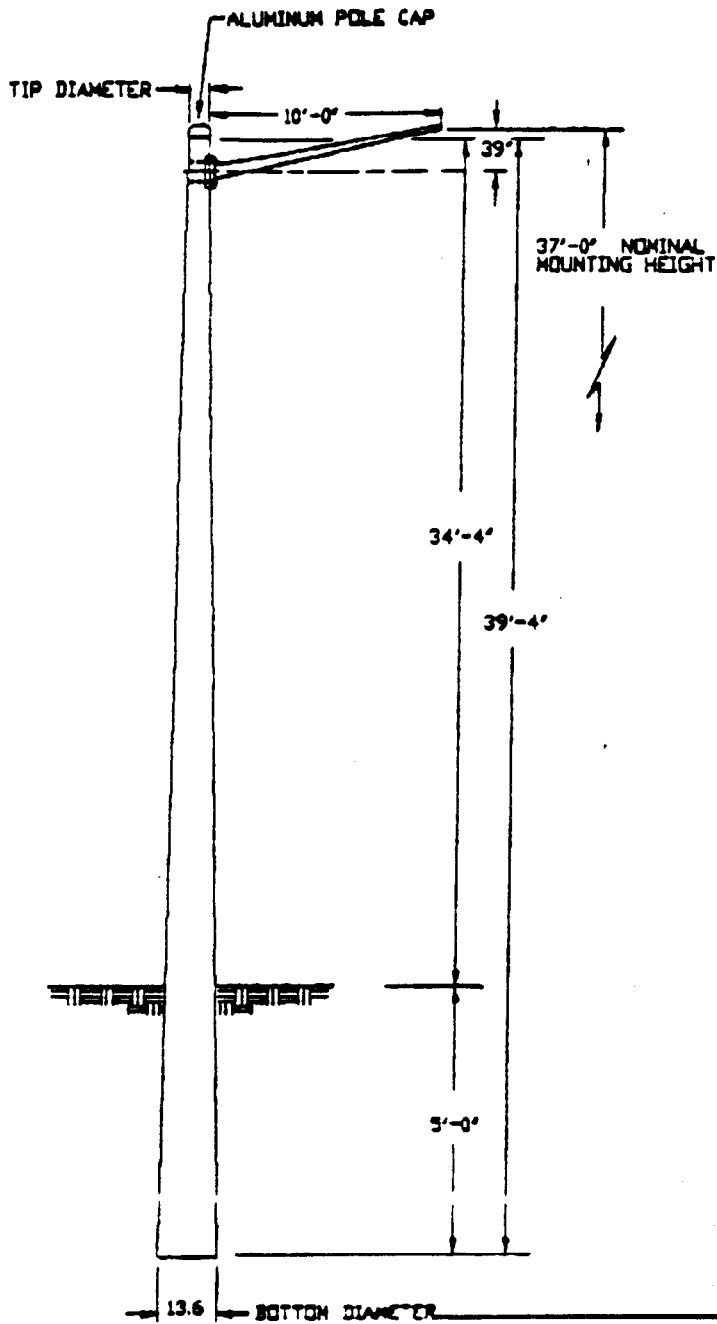

SOUTHWEST RESEARCH

CAT. NO. D-MB39-F-50-S10

SPECS	WIND VEL. 80 @ L3
TOT LENGTH 39'-4"	LUM. WEIGHT 90 LBS
EMBED. DEPTH 5'-0"	LUM. EPA 2 SQFT
TIP DIA. 5.12	STATIC DEFL. 0.8%
WEIGHT 246 LBS	TOTAL DEFL. 7.8%
DRAWN BY MURPHY	DATE 1-07-92

 SHERMAN
 POLE DIVISION

Figure 2. Manufacturer's Drawing of Test Article



U.S. Department
of Transportation

**Federal Highway
Administration**

April 18, 1997

400 Seventh St., S.W.
Washington, D.C. 20590

Refer to: HNG-14

Fouad H. Fouad, Ph.D., P.E.
Professor of Civil Engineering
Sherman Utility Structures, Inc
P.O. Box 1926
Birmingham, Alabama 35201

Dear Mr. Fouad:

This is in response to your letter of February 10 to Mr. Gerald L. Eller requesting that the Federal Highway Administration find an additional number of your company's breakaway fiberglass luminaire supports acceptable for use on the National Highway System (NHS). On June 10, 1992, we wrote to you indicating the acceptability of a range of poles based upon pendulum testing. Subsequently, on February 15, 1996, we indicated the acceptability of several more specific pole sizes and configurations that fell within the range of the poles found acceptable earlier. The breakaway performance of these poles is achieved by weakening various layers of the fiberglass mats near the ground line as well as adding a bondbreaker between the layers during fabrication of the pole. The pole is also strengthened above and below the impact zone with additional glass reinforcement. Your current request is to add new poles to the catalog of poles we found acceptable in 1992 and 1996. All of the new poles on your list are within the range of poles we have already found acceptable.

Therefore, the additional poles listed in the following table are acceptable for use on the NHS, if requested by a State.

Catalog #	Mtg. Ht mm (ft)	Shaft L. mm (ft)	Pole Mass kg (lbs)	Tip OD mm (in)	Butt OD mm (in)	# of Glass Layers	s-sect Area mm ² (in ²)
D-MB46-F-50-S6	12 600 (41.33)	14 000 (45.92)	103.9 (229)	130 (5.12)	382 (15.04)	5	6052 (9.38)
D-MB46-F-50-D6	12 170 (39.92)	14 000 (45.92)	107.2 (236)	130 (5.12)	382 (15.04)	5	6052 (9.38)
D-MB44-F-50-S6	11 760 (38.58)	13 208 (43.58)	96.1 (212)	130 (5.12)	369 (14.53)	5	6052 (9.38)
D-MB44-F-50-D6	11 760 (38.58)	13 208 (43.58)	98.8 (218)	130 (5.12)	369 (14.53)	5	6052 (9.38)
D-MB43-G-50-S8	11 560 (37.92)	13 080 (42.92)	102.7 (227)	148 (5.83)	384 (15.10)	5	6052 (9.38)
D-MB43-G-50-D8	11 560 (37.92)	13 080 (42.92)	104.1 (230)	148 (5.83)	384 (15.10)	5	6052 (9.38)
D-MB43-G-50-S10	11 380 (37.33)	12 900 (42.33)	104.2 (230)	148 (5.83)	380 (14.97)	5	6052 (9.38)
D-MB43-G-50-D10	11 380 (37.33)	12 900 (42.33)	104.2 (230)	148 (5.83)	380 (14.97)	5	6052 (9.38)
D-MB43-K-50-S12	11 200 (36.75)	13 030 (42.75)	110.3 (243)	158 (6.54)	401 (15.77)	5	6052 (9.38)
D-MB43-K-50-D12	11 200 (36.75)	13 003 (42.75)	110.3 (243)	158 (6.54)	401 (15.77)	5	6052 (9.38)

The pole that was tested in 1992 to qualify the range of poles found acceptable by our June 10, 1992, memo was:

D-MB39-F-50-S10	11 300 (37.00)	20 000 (39.37)	111.8 (246)	130 (5.12)	415 (16.34)	5	6 052 (9.38)
-----------------	----------------	----------------	-------------	------------	-------------	---	--------------

Details of the pole construction are shown in the enclosed drawings of the ten poles and a description of the breakaway features, also enclosed.

All conditions in our June 10, 1992, letter remain in effect.

Sincerely yours,

David A. Price

for

Dwight Horne, Chief
Federal-Aid and Design Division

6 Enclosures

Features of the breakaway device

Perfect shear of the pole upon impact was achieved through introducing the following modifications to the conventional pole design.

1. Cutting each glass laminate in the vicinity of the groundline. However not all glass layers are cut at the same section. Cuts are staggered approximately 4 inches apart
2. Placing a layer of polyethylene foil (approx. 40" wide x 17" long) between the glass layers in the vicinity of the impact zone. The foil has holes cut in approximately 50% of its area to allow the passage of the resin during spinning of the pole. The objective of the polyethylene foil is, to delaminate the pole in the impact zone, thus decreasing its shearing and flexural resistances considerably in that zone.
3. Providing additional glass reinforcement above and below the impact zone. This aids in confining the impact effect to the weakened zone and prevents failure from spreading to other regions of the pole.

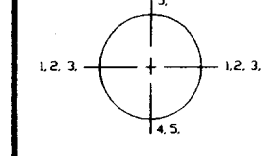
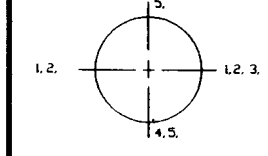
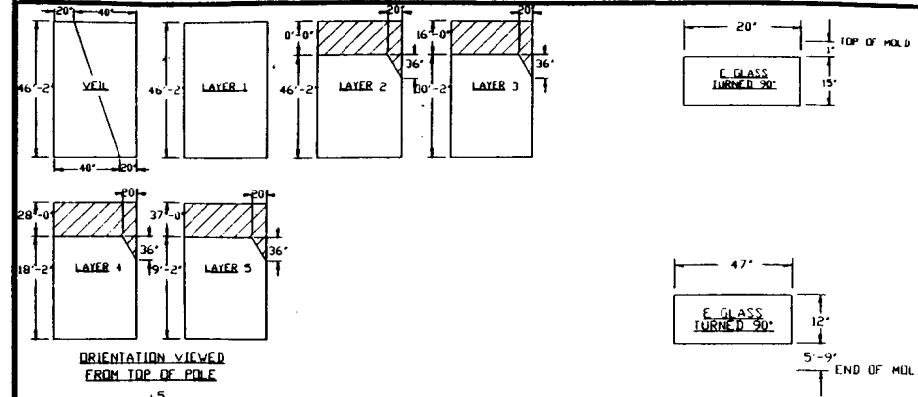
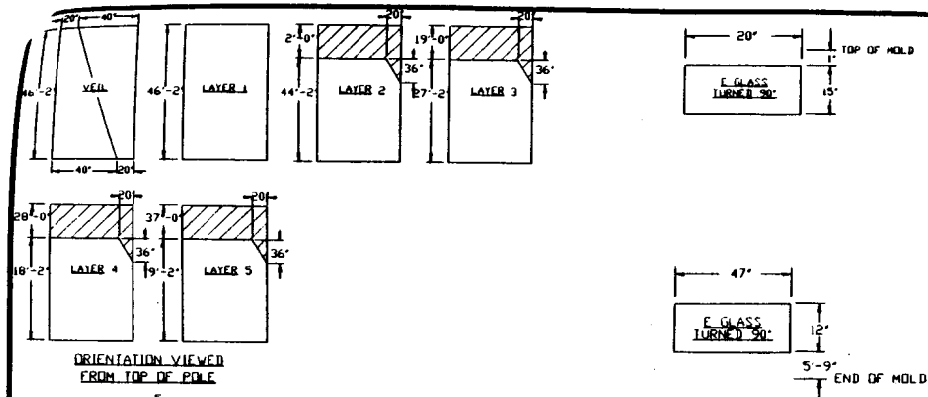

SHAFT INFORMATION
 MOLD SIZE
 TIP DIA. 5.12 IN. 130 MM
 MOLD LENGTH 46'-2 FT. 14 M.
 RESIN
 COLOR NO. _____
 VOLUME _____ GAL.

SHAFT INFORMATION
 MOLD SIZE
 TIP DIA. 5.12 IN. 130 MM
 MOLD LENGTH 46'-2 FT. 14 M.
 RESIN
 COLOR NO. _____
 VOLUME _____ GAL.

MATERIALS LIST PER POLE

2-1/2"x5" H/H 1 EA
 4"x12" H/H (FG) 1 EA
 2-1/2"x5" H/H (FG) 1 EA
 H/H FASTENER 1 EA
 SLOTTED HEX HEAD 1 EA
 3 POINT TAMPER NUT 1 EA
 SNAKE EYE TAMPER PROOF 1 EA
 STAINLESS STEEL SCREW 1 EA

TENON SIZE 0.0
 PIPE LENGTH IN.

POLE CAP (CAST AL) 1 EA
 POLE CAP (FG) 1 EA
 TENON CAP 1 EA

ANTI-ROTATION HOLES EA
 ANTI-ROT. WITH PIPE EA

ANCHOR BASE
 TYPE
 BOLT CIRCLE EA
 ANCHOR BOLTS EA
 DIAMETER IN
 LENGTH IN
 GALVANIZED YES/NO

ARMS
 4" CURLEE EA
 6" CURLEE EA
 8" CURLEE EA
 10" CURLEE EA
 12" CURLEE EA
 15" CURLEE EA
 40" FIBERGLAS EA

SINGLE MEMBER ARM
 TRUSS ARM YES/NO
 PAINT ARM YES/NO

MOUNTING HARDWARE STAINLESS STEEL
 GALVANIZED

TERMINAL BLOCK EA
 TYPE
 FUSE HOLDER EA
 GROMMET EA
 SIZE DIA.

MATERIALS LIST PER POLE

2-1/2"x5" H/H 1 EA
 4"x12" H/H (FG) 1 EA
 2-1/2"x5" H/H (FG) 1 EA
 H/H FASTENER 1 EA
 SLOTTED HEX HEAD 1 EA
 3 POINT TAMPER NUT 1 EA
 SNAKE EYE TAMPER PROOF 1 EA
 STAINLESS STEEL SCREW 1 EA

TENON SIZE 0.0
 PIPE LENGTH IN.

POLE CAP (CAST AL) 1 EA
 POLE CAP (FG) 1 EA
 TENON CAP 1 EA

ANTI-ROTATION HOLES EA
 ANTI-ROT. WITH PIPE EA

ANCHOR BASE
 TYPE
 BOLT CIRCLE EA
 ANCHOR BOLTS EA
 DIAMETER IN
 LENGTH IN
 GALVANIZED YES/NO

ARMS
 4" CURLEE EA
 6" CURLEE EA
 8" CURLEE EA
 10" CURLEE EA
 12" CURLEE EA
 15" CURLEE EA
 40" FIBERGLAS EA

SINGLE MEMBER ARM
 TRUSS ARM YES/NO
 PAINT ARM YES/NO

MOUNTING HARDWARE STAINLESS STEEL
 GALVANIZED

TERMINAL BLOCK EA
 TYPE
 FUSE HOLDER EA
 GROMMET EA
 SIZE DIA.

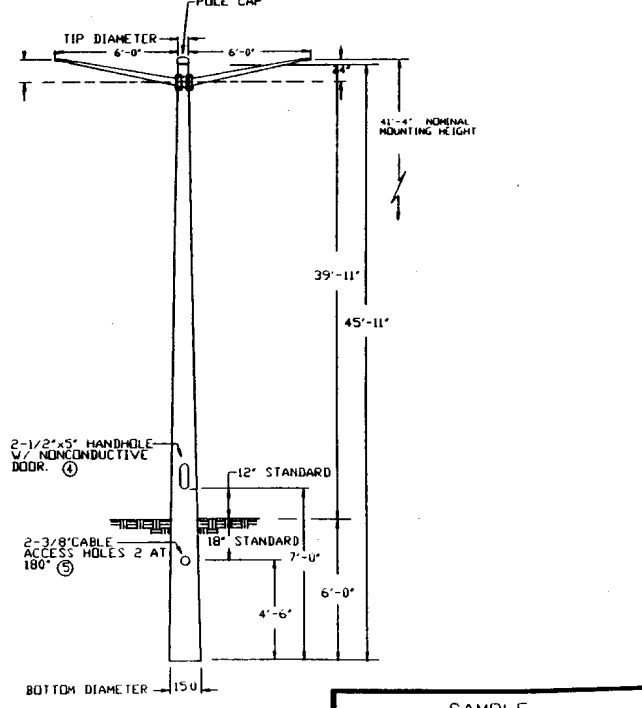
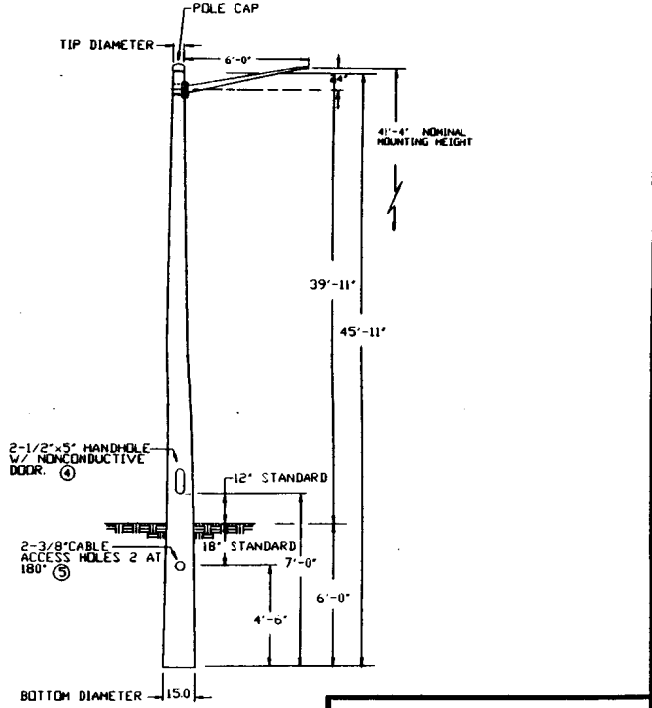

SAMPLE

CAT. NO. D-MB46-F-50-S6	WIND VEL. 90 8.3
TOT. LENGTH 45'-11"	LUM. WEIGHT 50 lbs
EMBED DEPTH 6'-0"	LUM. EPA 2 @ 20
TIP DIA. 5.12"	STATIC DEFL. 0.7%
WEIGHT 229 lbs	TOTAL DEFL. 9.5%
DRAWN BY: MURPHY	DATE: 9-23-96

SAMPLE

CAT. NO. D-MB46-F-50-D6	WIND VEL. 90 8.3
TOT. LENGTH 45'-11"	LUM. WEIGHT 50 lbs
EMBED DEPTH 6'-0"	LUM. EPA 2 @ 20
TIP DIA. 5.12"	STATIC DEFL. 0.0%
WEIGHT 236 lbs	TOTAL DEFL. 14.6%
DRAWN BY: MURPHY	DATE: 9-23-96

QUANTITY: 1	JOB NUMBER: SUBMIT
PO. NUMBER:	APPD BY:
REV. DATE BY:	REMARKS:

QUANTITY: 1	JOB NUMBER: SUBMIT
PO. NUMBER:	APPD BY:
REV. DATE BY:	REMARKS:

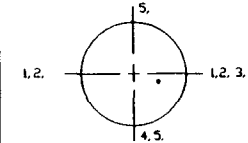
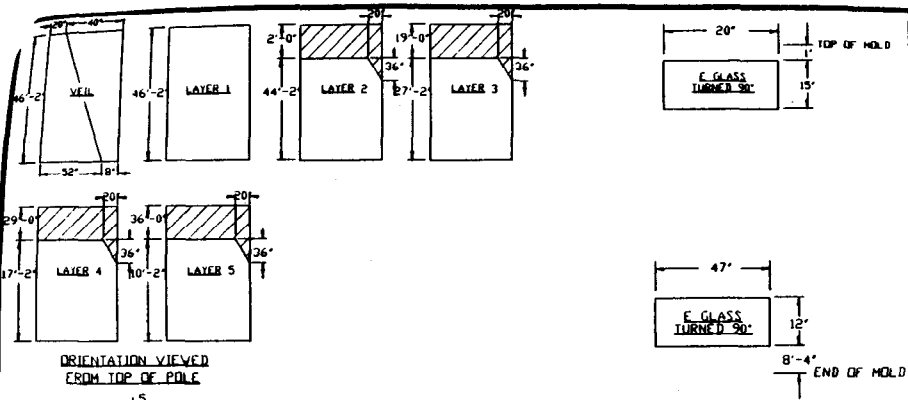

SHAFT INFORMATION

MOLD SIZE
 TIP DIA. 5.12 IN. 130 MM
 MOLD LENGTH 46'-2" FT. 14 M.
 RESIN
 COLOR NO. _____
 COLOR _____
 VOLUME _____ GAL.

MATERIALS LIST PER POLE

2-1/2"x5" H/H 1 EA
 4"x12" H/H (FG) EA
 2-1/2"x5" H/H (FG) EA
 H/H FASTENER EA
 SLOTTED HEX HEAD EA
 3 POINT TAMPER NUT EA
 SNAKE EYE TAMPER PROOF EA
 STAINLESS STEEL SCREW 1 EA
 TENDON SIZE D.D.
 PIPE LENGTH IN.
 POLE CAP (CAST AL) 1 EA
 POLE CAP (FG) EA
 TENDON CAP EA
 ANTI-ROTATION HOLES EA
 ANTI-ROT. WITH PIPE EA
 ANCHOR BASE
 TYPE
 BOLT CIRCLE EA
 ANCHOR BULBS IN.
 DIAMETER IN.
 LENGTH IN.
 GALVANIZED YES NO
 ARMS
 7' CURLEE EA
 6' CURLEE EA
 8' CURLEE EA
 10' CURLEE EA
 12' CURLEE EA
 15' CURLEE EA
 40' FIBERGLAS EA
 SINGLE MEMBER ARM
 TRUSS ARM
 PAINT ARM YES NO
 MOUNTING HARDWARE EA
 STAINLESS STEEL EA
 GALVANIZED
 TERMINAL BLOCK EA
 TYPE
 FUSE HOLDER EA
 GROMMET EA
 SIZE DIA.

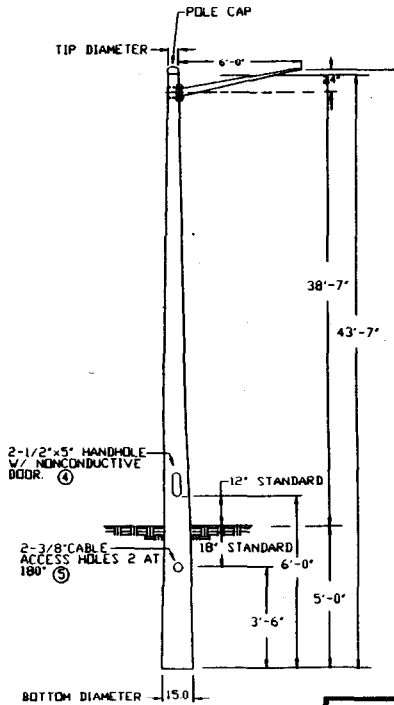

SAMPLE

CAT NO. D-MB44-F-50-S6
 SPECS: WIND VEL. 90 #3
 TOT. LENGTH 43'-7" LUM. WEIGHT. 50 lbs.
 EMBED DEPTH 5'-0" LUM. EPA 2.0 SQ FT
 TIP DIA. 5.12" STATIC DEFL. 0.7%
 WEIGHT 211 lbs TOTAL DEFL. 9.4%
 DRAWN BY. MURPHY DATE. 9-23-96

QUANTITY: 1 JOB NUMBER: SUBMIT
 PD NUMBER: APPD BY:
 REV DATE BY REMARKS

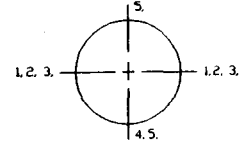
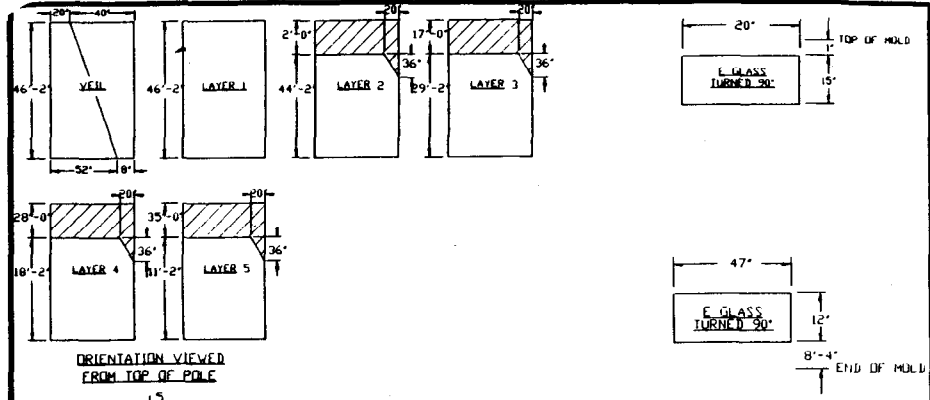

SHAFT INFORMATION

MOLD SIZE
 TIP DIA. 5.12 IN. 130 MM
 MOLD LENGTH 46'-2" FT. 14 M.
 RESIN
 COLOR NO. _____
 COLOR _____
 VOLUME _____ GAL.

MATERIALS LIST PER POLE

2-1/2"x5" H/H 1 EA
 4"x12" H/H (FG) EA
 2-1/2"x5" H/H (FG) EA
 H/H FASTENER EA
 SLOTTED HEX HEAD EA
 3 POINT TAMPER NUT EA
 SNAKE EYE TAMPER PROOF EA
 STAINLESS STEEL SCREW 1 EA
 TENDON SIZE D.D.
 PIPE LENGTH IN.
 POLE CAP (CAST AL) 1 EA
 POLE CAP (FG) EA
 TENDON CAP EA
 ANTI-ROTATION HOLES EA
 ANTI-ROT. WITH PIPE EA
 ANCHOR BASE
 TYPE
 BOLT CIRCLE EA
 ANCHOR BULBS IN.
 DIAMETER IN.
 LENGTH IN.
 GALVANIZED YES NO
 ARMS
 7' CURLEE EA
 6' CURLEE EA
 8' CURLEE EA
 10' CURLEE EA
 12' CURLEE EA
 15' CURLEE EA
 40' FIBERGLAS EA
 SINGLE MEMBER ARM
 TRUSS ARM
 PAINT ARM YES NO
 MOUNTING HARDWARE EA
 STAINLESS STEEL EA
 GALVANIZED
 TERMINAL BLOCK EA
 TYPE
 FUSE HOLDER EA
 GROMMET EA
 SIZE DIA.

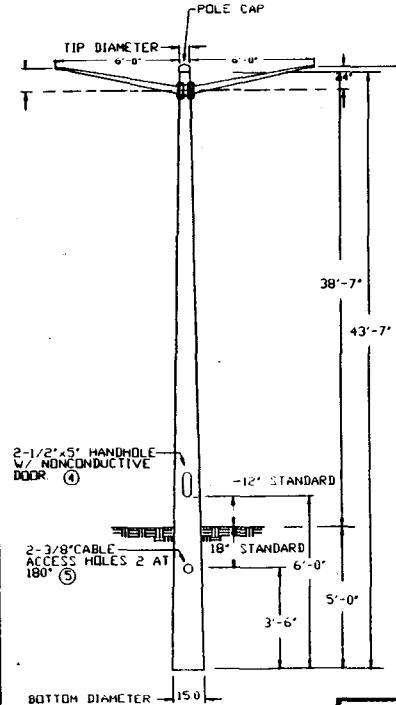

SAMPLE

CAT NO. D-MB44-F-50-D6
 SPECS: WIND VEL. 90 #3
 TOT. LENGTH 43'-7" LUM. WEIGHT. 50 lbs.
 EMBED DEPTH 5'-0" LUM. EPA: 2 @ 2.0
 TIP DIA. 5.12" STATIC DEFL. 0.0%
 WEIGHT 217 lbs TOTAL DEFL. 14.4%
 DRAWN BY. MURPHY DATE. 9-23-96

QUANTITY: 1 JOB NUMBER: SUBMIT
 PD NUMBER: APPD BY:
 REV DATE BY REMARKS

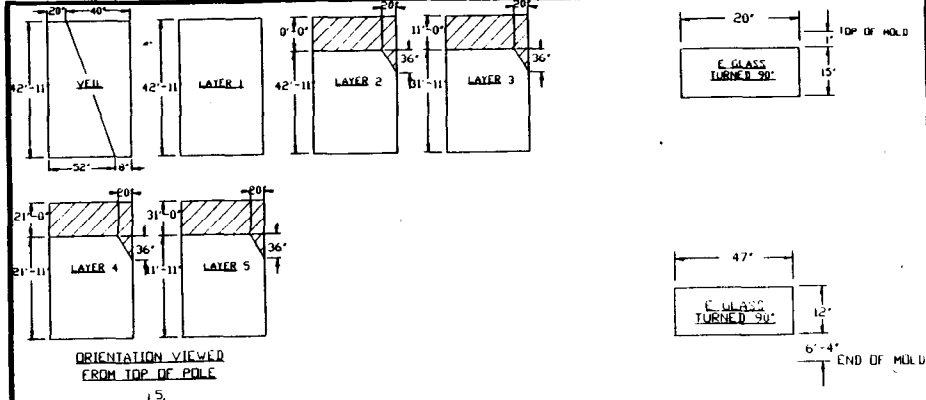
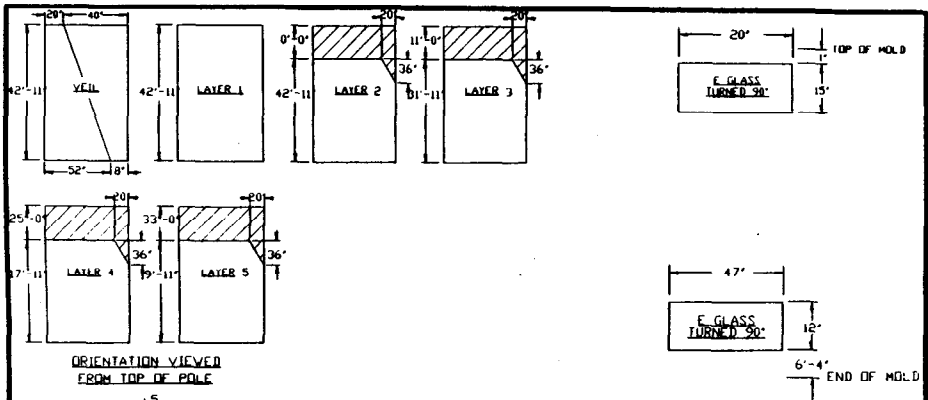

SHAFT INFORMATION
 MOLD SIZE
 TIP DIA. 5.83 IN. 149 MM.
 MOLD LENGTH 42'-11FT. 13 M.
 RESIN
 COLOR NO. _____
 COLOR _____
 VOLUME _____ GAL.

MATERIALS LIST PER POLE

2-1/2"x5" H/H 1 EA.
 4"x12" H/H (FG) EA.
 2-1/2"x5" H/H (FG) EA.
 H/H FASTENER EA.
 SLOTTED HEX HEAD EA.
 3 POINT TAMPER NUT EA.
 SWAKE EYE TAMPER PROOF EA.
 STAINLESS STEEL SCREW EA.

TENDON SIZE 0.8
 PIPE LENGTH IN.

POLE CAP (CAST AL) 1 EA.
 POLE CAP (FG) EA.
 TENDON CAP EA.

ANTI-ROTATION HOLES EA.
 ANTI-ROT. WITH PIPE EA.

ANCHOR BASE
 TYPE
 BOLT CIRCLE EA.
 ANCHOR BOLTS EA.
 DIAMETER IN.
 LENGTH IN.
 GALVANIZED YES NO

ARMS EA.
 4' CURLEE EA.
 6' CURLEE EA.
 8' CURLEE EA.
 10' CURLEE EA.
 12' CURLEE EA.
 15' CURLEE EA.
 40' FIBERGLAS EA.

SINGLE MEMBER ARM
 TRUSS ARM
 PAINT ARM 8 YES NO

MOUNTING HARDWARE 1 EA.
 STAINLESS STEEL GALVANIZED

TERMINAL BLOCK EA.
 FUSE HOLDER EA.
 GROMMET EA.
 SIZE DIA.

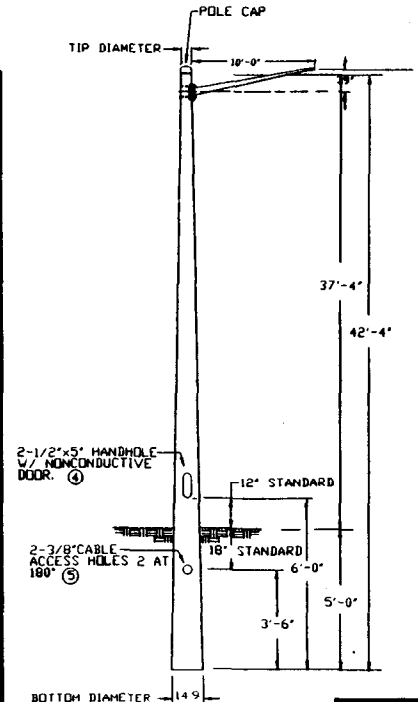

SAMPLE	
CAT NO. D-MB43-G-50-S10	
SPECS:	WIND VEL: 90 @ 3
TOT LENGTH 42'-4"	LUM WEIGHT: 50 lbs
EMBED DEPTH 5'-0"	LUM EPA 20 SOFT
TIP DIA: 5.83	STATIC DEFL 0.8%
WEIGHT: 229 lbs	TOTAL DEFL: 9.3%
DRAWN BY: MURPHY	DATE: 9-23-96

SHAFT INFORMATION
 MOLD SIZE
 TIP DIA. 5.83 IN. 149 MM.
 MOLD LENGTH 42'-11FT. 13 M.
 RESIN
 COLOR NO. _____
 COLOR _____
 VOLUME _____ GAL.

MATERIALS LIST PER POLE

2-1/2"x5" H/H 1 EA.
 4"x12" H/H (FG) EA.
 2-1/2"x5" H/H (FG) EA.
 H/H FASTENER EA.
 SLOTTED HEX HEAD EA.
 3 POINT TAMPER NUT EA.
 SWAKE EYE TAMPER PROOF EA.
 STAINLESS STEEL SCREW EA.

TENDON SIZE 0.8
 PIPE LENGTH IN.

POLE CAP (CAST AL) 1 EA.
 POLE CAP (FG) EA.
 TENDON CAP EA.

ANTI-ROTATION HOLES EA.
 ANTI-ROT. WITH PIPE EA.

ANCHOR BASE
 TYPE
 BOLT CIRCLE EA.
 ANCHOR BOLTS EA.
 DIAMETER IN.
 LENGTH IN.
 GALVANIZED YES NO

ARMS EA.
 4' CURLEE EA.
 6' CURLEE EA.
 8' CURLEE EA.
 10' CURLEE EA.
 12' CURLEE EA.
 15' CURLEE EA.
 40' FIBERGLAS EA.

SINGLE MEMBER ARM
 TRUSS ARM
 PAINT ARM 8 YES NO

MOUNTING HARDWARE 1 EA.
 STAINLESS STEEL GALVANIZED

TERMINAL BLOCK EA.
 FUSE HOLDER EA.
 GROMMET EA.
 SIZE DIA.

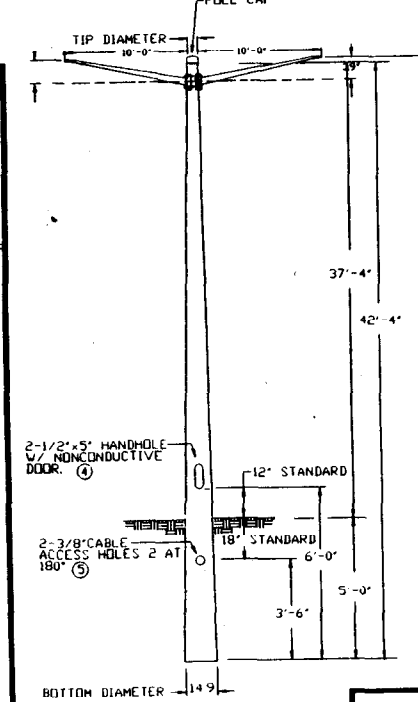

SAMPLE	
CAT NO. D-MB43-G-50-D10	
SPECS:	WIND VEL: 90 @ 3
TOT LENGTH 42'-4"	LUM WEIGHT: 50 lbs
EMBED DEPTH 5'-0"	LUM EPA 2 @ 20
TIP DIA: 5.83	STATIC DEFL 0.0%
WEIGHT: 239 lbs	TOTAL DEFL 14.7%
DRAWN BY: MURPHY	DATE: 9-23-96

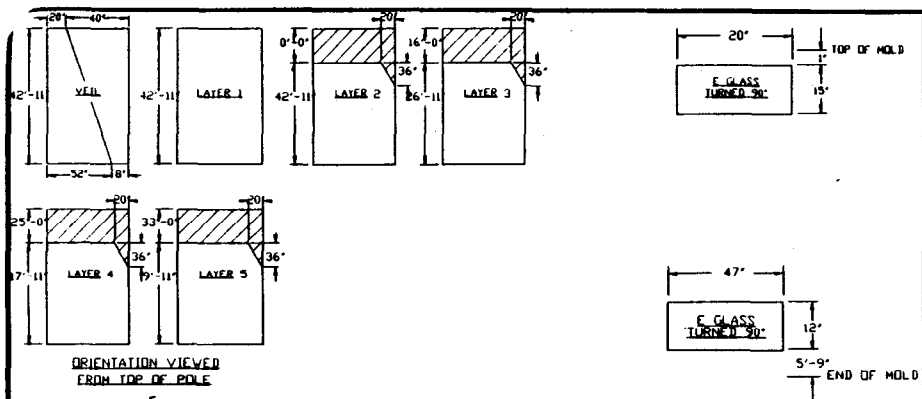

ORIENTATION VIEWED FROM TOP OF POLE

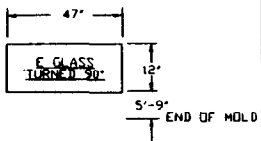

ORIENTATION VIEWED FROM TOP OF POLE

SHAFT INFORMATION
 MOLD SIZE
 TIP DIA. 5.83 IN 149 MM
 MOLD LENGTH 42'-11 FT. 13 M
 RESIN
 COLOR NO. _____
 VOLUME _____ GAL

MATERIALS LIST PER POLE

2-1/2"x5" H/H	1 EA
4"x12" H/H (FG)	1 EA
2-1/2"x5" H/H (FG)	1 EA
H/H FASTENERS	1 EA
SLOTTED HEX HEAD	1 EA
3 POINT TAMPER NUT	1 EA
SNAKE EYE TAMPER PROOF	1 EA
STAINLESS STEEL SCREW	1 EA
TENON SIZE	0.0
PIPE LENGTH	IN
POLE CAP (CAST AL)	1 EA
POLE CAP (FG)	1 EA
TENON CAP	1 EA
ANTI-ROTATION HOLES	EA
ANTI-ROT. WITH PIPE	EA
ANCHOR BASE	TYPE
BOLT CIRCLE	_____
ANCHOR BOLTS	EA
DIAMETER	_____
LENGTH	_____
GALVANIZED	YES NO
ARMS	EA
4" CURLEE	EA
6" CURLEE	EA
8" CURLEE	EA
10" CURLEE	EA
12" CURLEE	EA
15" CURLEE	EA
40" FIBERGLAS	EA
SINGLE MEMBER ARM	TRUSS ARM
PAINT ARM	YES NO
MOUNTING HARDWARE	EA
STAINLESS STEEL	EA
GALVANIZED	EA
TERMINAL BLOCK	EA
FUSE HOLDER	EA
GRONMET	EA
SIZE	DIA

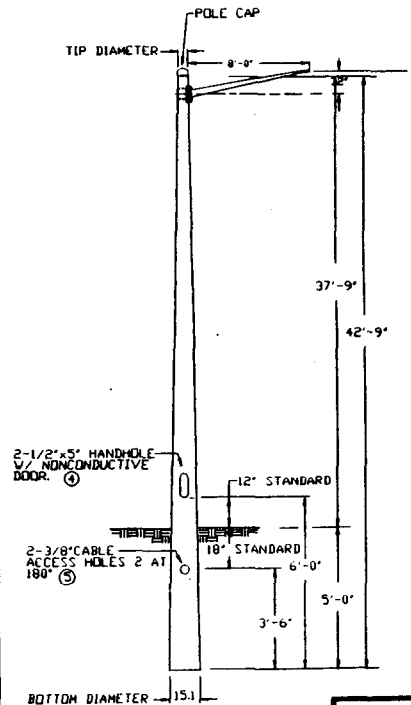

SAMPLE	
CAT. NO. D-MB43-G-50-SB	
SPECS:	WIND VEL. 90 @ 3
TOT LENGTH 42'-9"	LUM WEIGHT 50 lbs
EMBED. DEPTH 5'-0"	LUM EPA: 20 SOFT
TIP DIA. 5.83"	STATIC DEFL. 0.7%
WEIGHT 226 lbs	TOTAL DEFL. 9.6%
DRAWN BY: MURPHY	DATE: 9-23-96

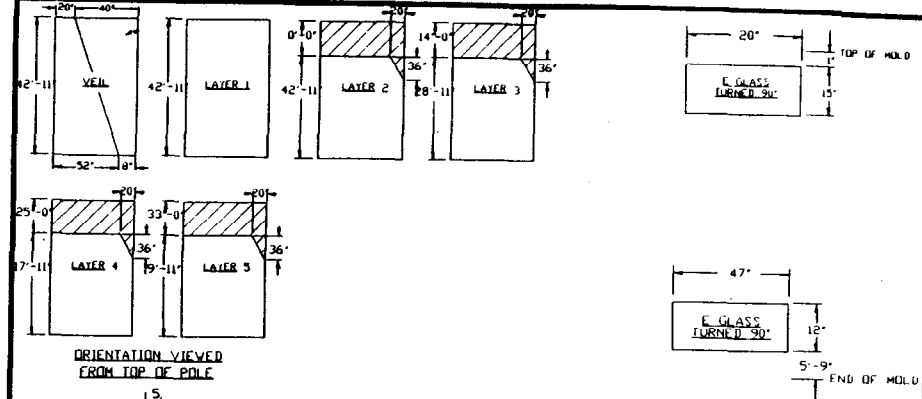

ORIENTATION VIEWED FROM TOP OF POLE

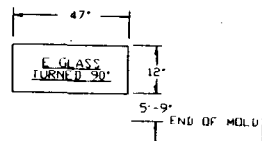

SHAFT INFORMATION
 MOLD SIZE
 TIP DIA. 5.83 IN 149 MM
 MOLD LENGTH 42'-11 FT. 13 M
 RESIN
 COLOR NO. _____
 VOLUME _____ GAL

MATERIALS LIST PER POLE

2-1/2"x5" H/H	1 EA
4"x12" H/H (FG)	1 EA
2-1/2"x5" H/H (FG)	1 EA
H/H FASTENERS	1 EA
SLOTTED HEX HEAD	1 EA
3 POINT TAMPER NUT	1 EA
SNAKE EYE TAMPER PROOF	1 EA
STAINLESS STEEL SCREW	1 EA
TENON SIZE	0.0
PIPE LENGTH	IN
POLE CAP (CAST AL)	1 EA
POLE CAP (FG)	1 EA
TENON CAP	1 EA
ANTI-ROTATION HOLES	EA
ANTI-ROT. WITH PIPE	EA
ANCHOR BASE	TYPE
BOLT CIRCLE	_____
ANCHOR BOLTS	EA
DIAMETER	_____
LENGTH	_____
GALVANIZED	YES NO
ARMS	EA
4" CURLEE	EA
6" CURLEE	EA
8" CURLEE	EA
10" CURLEE	EA
12" CURLEE	EA
15" CURLEE	EA
40" FIBERGLAS	EA
SINGLE MEMBER ARM	TRUSS ARM
PAINT ARM	YES NO
MOUNTING HARDWARE	EA
STAINLESS STEEL	EA
GALVANIZED	EA
TERMINAL BLOCK	EA
FUSE HOLDER	EA
GRONMET	EA
SIZE	DIA

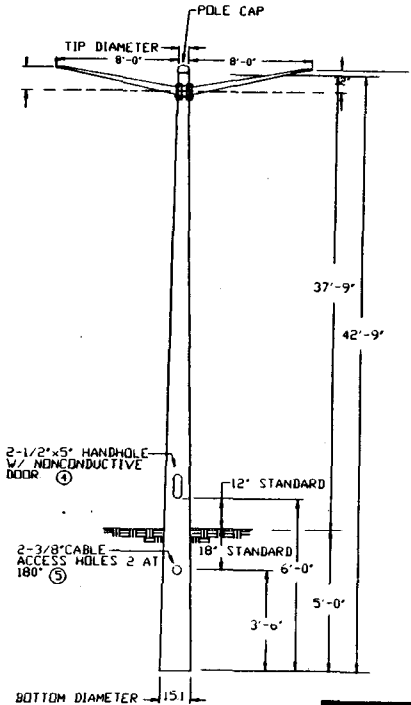

SAMPLE	
CAT. NO. D-MB43-G-50-SB	
SPECS:	WIND VEL. 90 @ 3
TOT LENGTH 42'-9"	LUM WEIGHT 50 lbs
EMBED. DEPTH 5'-0"	LUM EPA: 2 @ 20
TIP DIA. 5.83"	STATIC DEFL. 0.7%
WEIGHT 229 lbs	TOTAL DEFL. 13.5%
DRAWN BY: MURPHY	DATE: 9-23-96

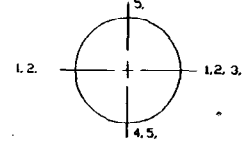
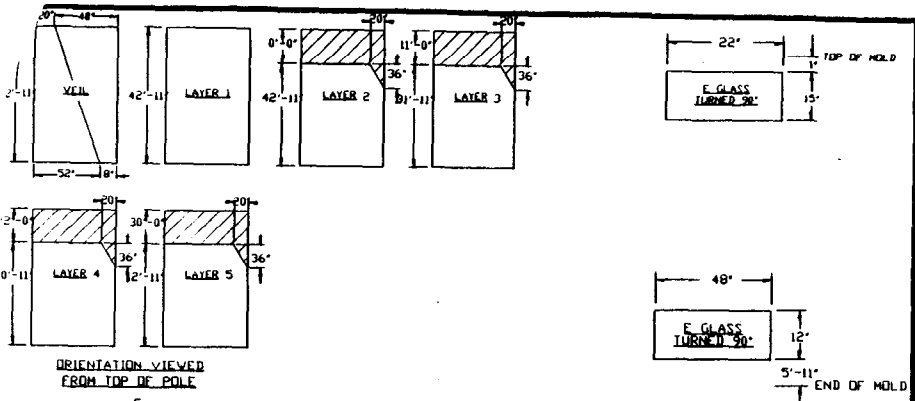

SHAFT INFORMATION
 MOLD SIZE
 TIP DIA. 6.54 IN. 166 MM
 MOLD LENGTH 42'-11 FT. 13 M
 RESIN
 COLOR NO. _____
 COLOR _____
 VOLUME _____ GAL.

- MATERIALS LIST PER POLE**
- 2-1/2"x5" H/H 1 EA.
 - 4"x12" H/H (FG) EA.
 - 2-1/2"x5" H/H (FG) EA.
 - H/H FASTENER: EA.
 - SLOTTED HEX HEAD EA.
 - 3 POINT TAMPER NUT EA.
 - SNAKE EYE TAMPER PROOF EA.
 - STAINLESS STEEL SCREW 1 EA.
 - TENDON SIZE O.D.
 - PIPE LENGTH IN.
 - POLE CAP (CAST AL) 1 EA.
 - POLE CAP (FG) EA.
 - TENDON CAP EA.
 - ANTI-ROTATION HOLES EA.
 - ANTI-ROT. WITH PIPE EA.
 - ANCHOR BASE EA.
 - BOLT CIRCLE EA.
 - ANCHOR BOLTS EA.
 - DIAMETER IN.
 - LENGTH IN.
 - GALVANIZED YES/NO
 - ARMS EA.
 - 4" CURLEE EA.
 - 6" CURLEE EA.
 - 8" CURLEE EA.
 - 10" CURLEE EA.
 - 12" CURLEE EA.
 - 15" CURLEE EA.
 - 40" FIBERGLAS EA.
 - SINGLE MEMBER ARM EA.
 - TRUSS ARM YES/NO
 - PAINT ARM YES/NO
 - MOUNTING HARDWARE EA.
 - STAINLESS STEEL EA.
 - GALVANIZED EA.
 - TERMINAL BLOCK EA.
 - FUSE HOLDER EA.
 - GROMMET EA.
 - SIZE DIA.

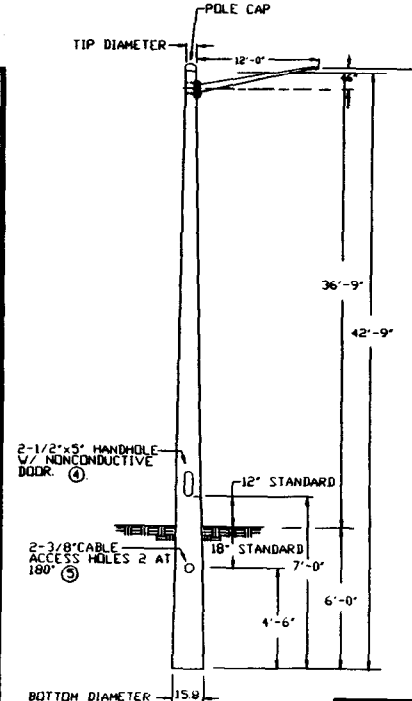

SAMPLE			
CAT NO. D-MB43-K-50-S12			
SPECS:	WIND VEL. 90 0.3		
TOT. LENGTH 42'-9"	LUM WEIGHT. 50 lbs		
EMBED. DEPTH 6'-0"	LUM EPA. 2.0 SOFT		
TIP DIA. 6.54"	STATIC DEFL. 0.8%		
WEIGHT 243 lbs	TOTAL DEFL. 8.4%		
DRAWN BY MURPHY	DATE 9-23-96		

QUANTITY	JOB NUMBER	SUBMIT
1		
PO. NUMBER:	APPD BY:	
REV. DATE BY:	REMARKS	

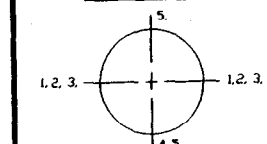
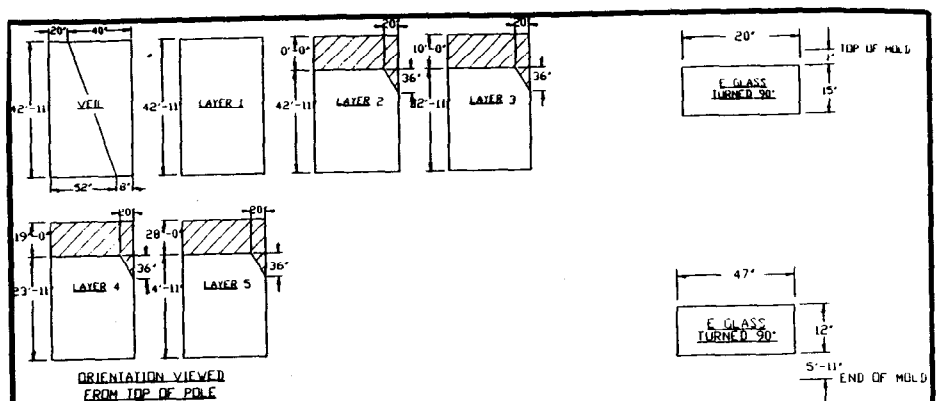

SHAFT INFORMATION
 MOLD SIZE
 TIP DIA. 6.54 IN. 166 MM
 MOLD LENGTH 42'-11 FT. 13 M
 RESIN
 COLOR NO. _____
 COLOR _____
 VOLUME _____ GAL.

- MATERIALS LIST PER POLE**
- 2-1/2"x5" H/H 1 EA.
 - 4"x12" H/H (FG) EA.
 - 2-1/2"x5" H/H (FG) EA.
 - H/H FASTENER: EA.
 - SLOTTED HEX HEAD EA.
 - 3 POINT TAMPER NUT EA.
 - SNAKE EYE TAMPER PROOF EA.
 - STAINLESS STEEL SCREW 1 EA.
 - TENDON SIZE O.D.
 - PIPE LENGTH IN.
 - POLE CAP (CAST AL) 1 EA.
 - POLE CAP (FG) EA.
 - TENDON CAP EA.
 - ANTI-ROTATION HOLES EA.
 - ANTI-ROT. WITH PIPE EA.
 - ANCHOR BASE EA.
 - BOLT CIRCLE EA.
 - ANCHOR BOLTS EA.
 - DIAMETER IN.
 - LENGTH IN.
 - GALVANIZED YES/NO
 - ARMS EA.
 - 4" CURLEE EA.
 - 6" CURLEE EA.
 - 8" CURLEE EA.
 - 10" CURLEE EA.
 - 12" CURLEE EA.
 - 15" CURLEE EA.
 - 40" FIBERGLAS EA.
 - SINGLE MEMBER ARM EA.
 - TRUSS ARM YES/NO
 - PAINT ARM YES/NO
 - MOUNTING HARDWARE EA.
 - STAINLESS STEEL EA.
 - GALVANIZED EA.
 - TERMINAL BLOCK EA.
 - FUSE HOLDER EA.
 - GROMMET EA.
 - SIZE DIA.

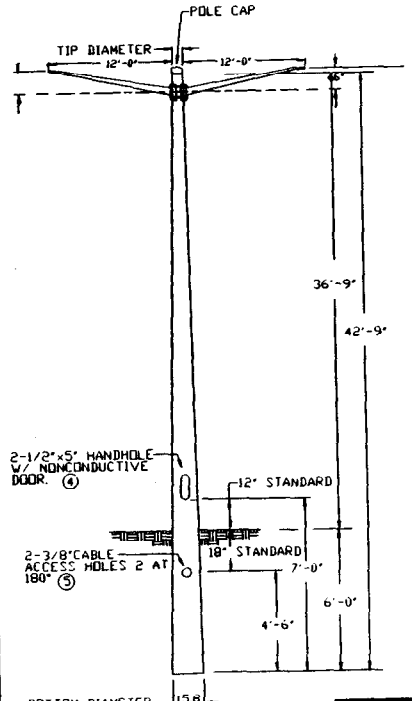

SAMPLE			
CAT NO. D-MB43-K-50-D12			
SPECS:	WIND VEL. 90 0.3		
TOT. LENGTH 42'-9"	LUM WEIGHT. 50 lbs		
EMBED. DEPTH 6'-0"	LUM EPA. 2.0 SOFT		
TIP DIA. 6.54"	STATIC DEFL. 0.0%		
WEIGHT 252 lbs	TOTAL DEFL. 13.4%		
DRAWN BY MURPHY	DATE 9-23-96		

QUANTITY	JOB NUMBER	SUBMIT
1		
PO. NUMBER:	APPD BY:	
REV. DATE BY:	REMARKS	