



U.S. Department  
of Transportation  
**Federal Highway  
Administration**

January 30, 2019

1200 New Jersey Ave., SE  
Washington, D.C. 20590

In Reply Refer To:  
HSST-1/SS-184

Mr. Micheal Frey  
Frey Manufacturing  
13150 Stewart Avenue  
Norwood, MN. 55368

Dear Mr. Frey:

This letter is in response to your November 8, 2018 request for the Federal Highway Administration (FHWA) to review a roadside safety device, hardware, or system for eligibility for reimbursement under the Federal-aid highway program. This FHWA letter of eligibility is assigned FHWA control number SS-184 and is valid until a subsequent letter is issued by FHWA that expressly references this device.

### **Decision**

The following device is eligible within the length-of-need, with details provided in the form which is attached as an integral part of this letter:

- Pedestrian Signal Pole

### **Scope of this Letter**

To be found eligible for Federal-aid funding, new roadside safety devices should meet the crash test and evaluation criteria contained in the American Association of State Highway and Transportation Officials' (AASHTO) Manual for Assessing Safety Hardware (MASH). However, the FHWA, the Department of Transportation, and the United States Government do not regulate the manufacture of roadside safety devices. Eligibility for reimbursement under the Federal-aid highway program does not establish approval, certification or endorsement of the device for any particular purpose or use.

This letter is not a determination by the FHWA, the Department of Transportation, or the United States Government that a vehicle crash involving the device will result in any particular outcome, nor is it a guarantee of the in-service performance of this device. Proper manufacturing, installation, and maintenance are required in order for this device to function as tested.

This finding of eligibility is limited to the crashworthiness of the system and does not cover other structural features, nor conformity with the Manual on Uniform Traffic Control Devices.

### **Eligibility for Reimbursement**

Based solely on a review of crash test results and certifications submitted by the manufacturer, and the crash test laboratory, FHWA agrees that the device described herein meets the crash test and evaluation criteria of the AASHTO's MASH. Therefore, the device is eligible for reimbursement under the Federal-aid highway program if installed under the range of tested conditions.

Name of system: Pedestrian Signal Pole

Type of system: Sign Support

Test Level: MASH Test Level 3 (TL3)

Testing conducted by: KARCO

Date of request: November 14, 2018

FHWA concurs with the recommendation of the accredited crash testing laboratory on the attached Form.

### **Full Description of the Eligible Device**

The device and supporting documentation, including reports of the crash tests or other testing done, videos of any crash testing, and/or drawings of the device, are described in the attached form.

### **Notice**

This eligibility letter is issued for the subject device as tested. Modifications made to the device are not covered by this letter. Any modifications to this device should be submitted to the user (i.e., state DOT) as per their requirements.

You are expected to supply potential users with sufficient information on design, installation and maintenance requirements to ensure proper performance.

You are expected to certify to potential users that the hardware furnished has the same chemistry, mechanical properties, and geometry as that submitted for review, and that it will meet the test and evaluation criteria of AASHTO's MASH.

Issuance of this letter does not convey property rights of any sort or any exclusive privilege. This letter is based on the premise that information and reports submitted by you are accurate and correct. We reserve the right to modify or revoke this letter if: (1) there are any inaccuracies in the information submitted in support of your request for this letter, (2) the qualification testing was flawed, (3) in-service performance or other information reveals safety problems, (4) the system is significantly different from the version that was crash tested, or (5) any other information indicates that the letter was issued in error or otherwise does not reflect full and complete information about the crashworthiness of the system.

### Standard Provisions

- To prevent misunderstanding by others, this letter of eligibility designated as FHWA control number SS-184 shall not be reproduced except in full. This letter and the test documentation upon which it is based are public information. All such letters and documentation may be reviewed upon request.
- This letter shall not be construed as authorization or consent by the FHWA to use, manufacture, or sell any patented system for which the applicant is not the patent holder.
- This FHWA eligibility letter is not an expression of any Agency view, position, or determination of validity, scope, or ownership of any intellectual property rights to a specific device or design. Further, this letter does not impute any distribution or licensing rights to the requester. This FHWA eligibility letter determination is made based solely on the crash-testing information submitted by the requester. The FHWA reserves the right to review and revoke an earlier eligibility determination after receipt of subsequent information related to crash testing.
- If the subject device is a patented product it may be considered to be proprietary. If proprietary systems are specified by a highway agency for use on Federal-aid projects: (a) they must be supplied through competitive bidding with equally suitable unpatented items; (b) the highway agency must certify that they are essential for synchronization with the existing highway facilities or that no equally suitable alternative exists; or (c) they must be used for research or for a distinctive type of construction on relatively short sections of road for experimental purposes. Our regulations concerning proprietary products are contained in Title 23, Code of Federal Regulations, Section 635.411.

Sincerely,



Michael S. Griffith  
Director, Office of Safety Technologies  
Office of Safety

Enclosures



## Request for Federal Aid Reimbursement Eligibility of Highway Safety Hardware

<b>Submitter</b>	Date of Request:	November 08, 2018	<input checked="" type="radio"/> New <input type="radio"/> Resubmission
	Name:	Robert Ramirez	
	Company:	Applus IDIADA KARCO Engineering	
	Address:	9270 Holly Rd. Adelanto, CA 92301	
	Country:	USA	
	To:	Michael S. Griffith, Director FHWA, Office of Safety Technologies	

I request the following devices be considered eligible for reimbursement under the Federal-aid highway program.

**Device & Testing Criterion** - Enter from right to left starting with Test Level

!-!-!

System Type	Submission Type	Device Name / Variant	Testing Criterion	Test Level
'SS': Breakaway Sign Supports, Mailboxes, & other small sign supports	<input checked="" type="radio"/> Physical Crash Testing <input type="radio"/> Engineering Analysis	Pedestrian Signal Pole	AASHTO MASH	TL3

By submitting this request for review and evaluation by the Federal Highway Administration, I certify that the product(s) was (were) tested in conformity with the AASHTO Manual for Assessing Safety Hardware and that the evaluation results meet the appropriate evaluation criteria in the MASH.

**Individual or Organization responsible for the product:**

Contact Name:	Mike Frey	Same as Submitter <input type="checkbox"/>
Company Name:	Frey Manufacturing	Same as Submitter <input type="checkbox"/>
Address:	13150 Stewart Ave. Norwood, MN 55368	Same as Submitter <input type="checkbox"/>
Country:	USA	Same as Submitter <input type="checkbox"/>

Enter below all disclosures of financial interests as required by the FHWA 'Federal-Aid Reimbursement Eligibility Process for Safety Hardware Devices' document.

Frey Manufacturing and Applus IDIADA KARCO Engineering LLC share no financial interests between the two organizations. This includes no shared financial interest but not limited to:

- i. Compensation including wages, salaries, commissions, professional fees, or fees for business referrals
- iii. Research funding or other forms of research support;
- iv. Patents, copyrights, licenses, and other intellectual property interests;
- vi. Business ownership and investment interests;

## PRODUCT DESCRIPTION

- New Hardware or Significant Modification
  Modification to Existing Hardware

The Frey Manufacturing Pedestrian Signal Pole is a support structure composed of circular pipe support and a signal pedestal assembly. The as-tested configuration of the Pedestrian Signal Pole was tested with an accessible pedestrian signal (APS) push button station and traffic control signal controllers.

The support was constructed of a 4.5 in. (114 mm) diameter aluminum pipe with a thickness of 0.3 in. (8 mm). The pipe had a length of 15.0 ft. (4.6 m). The bottom of the support pipe was threaded into the pedestal assembly and secured in place with two (2) set screws.

The pedestal assembly was composed of a pedestal and access door. The pedestal was 10.0 in. (254 mm) tall and had the access door incorporated into one of its sides. The pedestal was anchored to the ground with four (4) 0.625 in. (16 mm) diameter by 7.5 in. (191 mm) long threaded studs, four (4) washers, and four (nuts). The anchors had an embedment depth of 4.0 in. (102 mm) to 5.0 in. (127 mm). The threaded rods were epoxied into a 6.0 in. (152 mm) thick concrete pad for this test.

## CRASH TESTING

By signature below, the Engineer affiliated with the testing laboratory, agrees in support of this submission that all of the critical and relevant crash tests for this device listed above were conducted to meet the MASH test criteria. The Engineer has determined that no other crash tests are necessary to determine the device meets the MASH criteria.

Engineer Name:	Robert Ramirez	
Engineer Signature:	<b>Robert Ramirez</b>	Digitally signed by Robert Ramirez DN: cn=Robert Ramirez, o=KARCO Engineering, ou=Project Engineer, email=rramirez@karco.com, c=US Date: 2018.11.12 14:41:07 -08'00'
Address:	9270 Holly Rd. Adelanto, CA 92301	Same as Submitter <input checked="" type="checkbox"/>
Country:	USA	Same as Submitter <input checked="" type="checkbox"/>

A brief description of each crash test and its result:

Required Test Number	Narrative Description	Evaluation Results
3-60 (1100C)	<p>Applus IDIADA KARCO test number P38168-01. An 1100C test vehicle impacting the support at a nominal speed of 19 mph (30 km/h). This test is designed to evaluate the kinetic energy required to activate the release mechanism of the support. The test vehicle, a 2013 Kia Rio 4-door sedan with a test inertial weight of 2,426.1 lbs (1,100.5 kg) impacted the device at a speed of 18.68 mph (30.06 km/h). The support was activated in a controlled manner and did not cause excessive velocity change. The device impacted the roof but the deformation limits were not exceeded and there was no penetration into the occupant compartment. The occupant impact velocity in the lateral and longitudinal direction were 0.3 ft/s (0.1 m/s) and 4.9 ft/s (1.5 m/s), respectively. The ridedown accelerations in the longitudinal and lateral directions were 0.5 g and 1.0 g, respectively. The Frey Manufacturing Pedestrian Signal Pole met all the requirements for MASH Test 3-60.</p>	PASS
3-61 (1100C)	<p>Applus IDIADA KARCO test number P38168-02. An 1100C test vehicle impacting the support at a nominal speed of 62 mph (100 km/h). This test is designed to evaluate the behavior of the feature during high-speed impacts. The test vehicle, a 2012 Kia Rio 4-door sedan with a test inertial weight of 2,410.7 lbs (1,093.5 kg) impacted the device at a speed of 60.99 mph (98.15 km/h). The support was activated in a controlled manner and did not cause excessive velocity change. The device rotated over the top of the vehicle and did not contact the windshield or roof. The occupant impact velocity in the lateral and longitudinal direction were 0.3 ft/s (1.0 m/s) and 1.0 ft/s (3.3 m/s), respectively. The ridedown accelerations in the longitudinal and lateral directions were 0.2 g and 0.3 g, respectively. The occupant risk values were below the preferred values in MASH and there was no penetration into the occupant compartment. The Frey Manufacturing Pedestrian Signal Pole met all the requirements for MASH Test 3-61.</p>	PASS

Required Test Number	Narrative Description	Evaluation Results
3-62 (2270P)	Applus IDIADA KARCO test number P38168-03. An 2270P test vehicle impacting the support at a nominal speed of 62 mph (100 km/h). This test is designed to evaluate the behavior of the feature during high-speed impacts. The test vehicle, a 2012 RAM 1500 4-door pickup truck with a test inertial weight of 5,060.6 lbs (2,295.5 kg) impacted the device at a speed of 63.58 mph (101.75 km/h). The support was activated in a controlled manner and did not cause excessive velocity change. There was no occupant compartment deformation or penetration. There was not sufficient velocity change to create occupant impact velocities and as a result the ridedown accelerations were also zero. The occupant risk values were below the preferred values in MASH and there was no penetration into the occupant compartment. The Frey Manufacturing Pedestrian Signal Pole met all the requirements for MASH Test 3-62.	PASS

Full Scale Crash Testing was done in compliance with MASH by the following accredited crash test laboratory (cite the laboratory's accreditation status as noted in the crash test reports.):

Laboratory Name:	Applus IDIADA KARCO Engineering	
Laboratory Signature:	<b>Robert Ramirez</b>	Digitally signed by Robert Ramirez DN: cn=Robert Ramirez, o=KARCO Engineering, ou=Project Engineer, email=rramirez@karco.com, c=US Date: 2018.11.14 09:48:37 -08'00'
Address:	9270 Holly Rd. Adelanto, CA 92301	Same as Submitter <input checked="" type="checkbox"/>
Country:	USA	Same as Submitter <input checked="" type="checkbox"/>
Accreditation Certificate Number and Dates of current Accreditation period :	TL-371 Valid up to July 1, 2019	

Submitter Signature\*: Robert Ramirez

Digitally signed by Robert Ramirez  
DN: cn=Robert Ramirez, o=KARCO  
Engineering, ou=Project Engineer,  
email=rramirez@karco.com, c=US  
Date: 2018.11.14 09:48:52 -08'00'

Submit Form

ATTACHMENTS



Attach to this form:

- 1) Additional disclosures of related financial interest as indicated above.
- 2) A copy of the full test report, video, and a Test Data Summary Sheet for each test conducted in support of this request.
- 3) A drawing or drawings of the device(s) that conform to the Task Force-13 Drawing Specifications [[Hardware Guide Drawing Standards](#)]. For proprietary products, a single isometric line drawing is usually acceptable to illustrate the product, with detailed specifications, intended use, and contact information provided on the reverse. Additional drawings (not in TF-13 format) showing details that are relevant to understanding the dimensions and performance of the device should also be submitted to facilitate our review.

**FHWA Official Business Only:**

Eligibility Letter		
Number	Date	Key Words



## MASH Test 3-60 SUMMARY



0.000 s

0.200 s

0.400 s

0.600 s

1.000 s

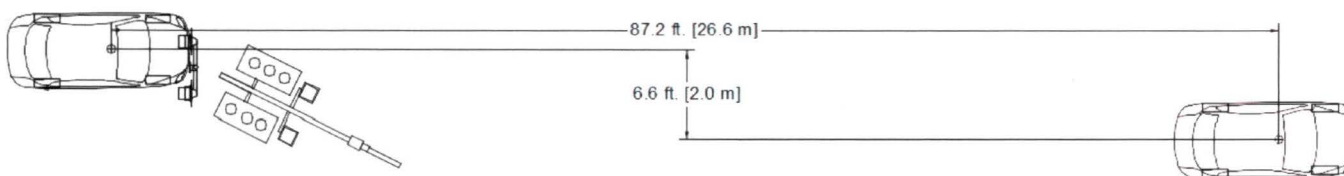

<b>GENERAL INFORMATION</b>	
Test Agency.....	KARCO Engineering, LLC.
KARCO Test No.....	P38168-01
Test Designation.....	3-60
Test Date.....	06/28/18
<b>TEST ARTICLE</b>	
Name / Model.....	Pedestrian Signal Pole
Type.....	Support Structure
Device Height .....	14.8 ft. (4.5 m)
Key Elements.....	Support and Pedestal
Road Surface.....	Concrete
<b>TEST VEHICLE</b>	
Type / Designation.....	1100C
Year, Make, and Model....	2013 Kia Rio
Curb Mass.....	2,538.6 lbs (1,151.5 kg)
Test Inertial Mass.....	2,426.1 lbs (1,100.5 kg)
Gross Static Mass.....	2,590.4 lbs (1,175.0 kg)

<b>Impact Conditions</b>	
Impact Velocity.....	18.68 mph (30.06 km/h)
Impact Angle.....	0.0°
Location / Orientation.....	Offset 17.0 in. (431 mm)
Kinetic Energy.....	28.3 kip-ft (38.4 kJ)
<b>Exit Conditions</b>	
Exit Velocity.....	16.47 mph (26.51 km/h)
Exit Angle.....	0.0°
Final Vehicle	87.2 ft. (26.6 m ) Downstream
	6.6 ft. (2 m) Right
Exit Box Criteria Met.....	N/A
Vehicle Snagging.....	None
Vehicle Pocketing.....	None
Maximum Roll Angle.....	-12.3 °
Maximum Pitch Angle.....	0.8 °
Maximum Yaw Angle.....	-2.4 °

<b>Occupant Risk</b>	
Longitudinal OIV.....	0.3 ft/s (0.1 m/s)
Lateral OIV.....	4.9 ft/ (1.5 m/s)
Longitudinal RA.....	0.5 g
Lateral RA.....	1.0 g
THIV.....	4.9 ft/s (1.5 m/s)
PHD.....	1.1 g
ASI.....	0.16
<b>Test Article Deflections</b>	
Debris Field (longitudinal) ...	65.3 ft. (19.9 m)
Debris Field (lateral).....	7.9 ft. (2.4 m)
<b>Vehicle Damage</b>	
Vehicle Damage Scale.....	N/A
CDC.....	12TCDW1
Maximum Intrusion.....	2.3 in. (58 mm)

**Figure 3 Test 3-60 Summary**

## MASH Test 3-61 SUMMARY

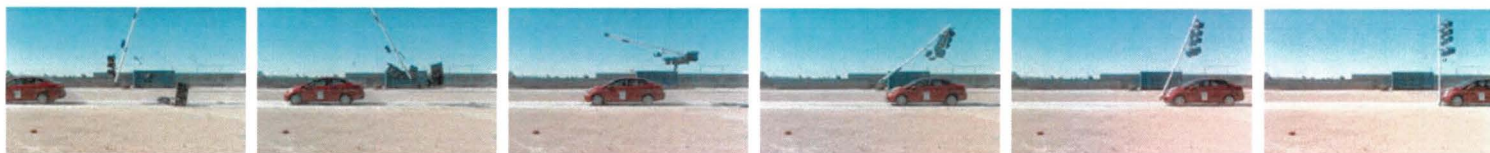

0.400 s

0.300 s

0.200 s

0.100 s

0.050 s

0.000 s

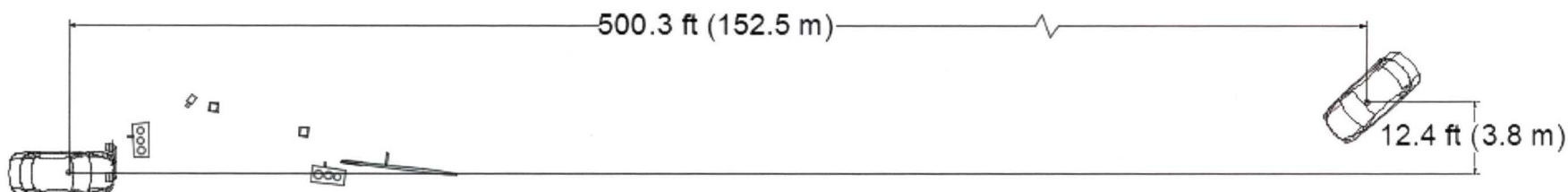

<b>GENERAL INFORMATION</b>	
Test Agency.....	KARCO Engineering, LLC.
KARCO Test No.....	P38168-02
Test Designation.....	3-61
Test Date.....	06/28/18
<b>TEST ARTICLE</b>	
Name / Model.....	Pedestrian Signal Pole
Type.....	Support Structure
Device Height .....	14.8 ft. (4.5 m)
Key Elements.....	Support and Pedestal
Road Surface.....	Concrete
<b>TEST VEHICLE</b>	
Type / Designation.....	1100C
Year, Make, and Model....	2012 Kia Rio
Curb Mass.....	2,497.8 lbs (1,133.0 kg)
Test Inertial Mass.....	2,410.7 lbs (1,093.5 kg)
Gross Static Mass.....	2,579.4 lbs (1,170.0 kg)

<b>Impact Conditions</b>	
Impact Velocity.....	60.99 mph (98.15 km/h)
Impact Angle.....	0.0°
Location / Orientation.....	Offset 17.0 in. (431 mm)
Kinetic.....	299.7 kip-ft (406.4 kJ)
<b>Exit Conditions</b>	
Exit Velocity.....	58.06 mph (93.44 km/h)
Exit Angle.....	0.0°
Final Vehicle.....	500.3 ft. (152.5 m) dw 12.4 ft. (3.8 m) Left
Exit Box Criteria Met.....	N/A
Vehicle Snagging.....	None
Vehicle Pocketing.....	None
Maximum Roll Angle.....	4.4°
Maximum Pitch Angle.....	5.6°
Maximum Yaw Angle.....	-3.1°

<b>Occupant Risk</b>	
Longitudinal OIV.....	0.3 m/s (1.0 ft/s)
Lateral OIV.....	1.0 m/s (3.3 ft/s)
Longitudinal RA.....	0.2 g
Lateral RA.....	0.3 g
THIV.....	1.0 m/s (3.3 ft/s)
PHD.....	0.3 g
ASI.....	0.20
<b>Test Article Deflections</b>	
Debris Field (longitudinal) ...	146.8 ft. (44.7 m)
Debris Field (lateral).....	17.9 ft. (5.5 m)
<b>Vehicle Damage</b>	
Vehicle Damage Scale.....	N/A
CDC.....	N/A
Maximum Intrusion.....	N/A

Figure 2 Test 3-61 Summary

# MASH Test 3-62 SUMMARY

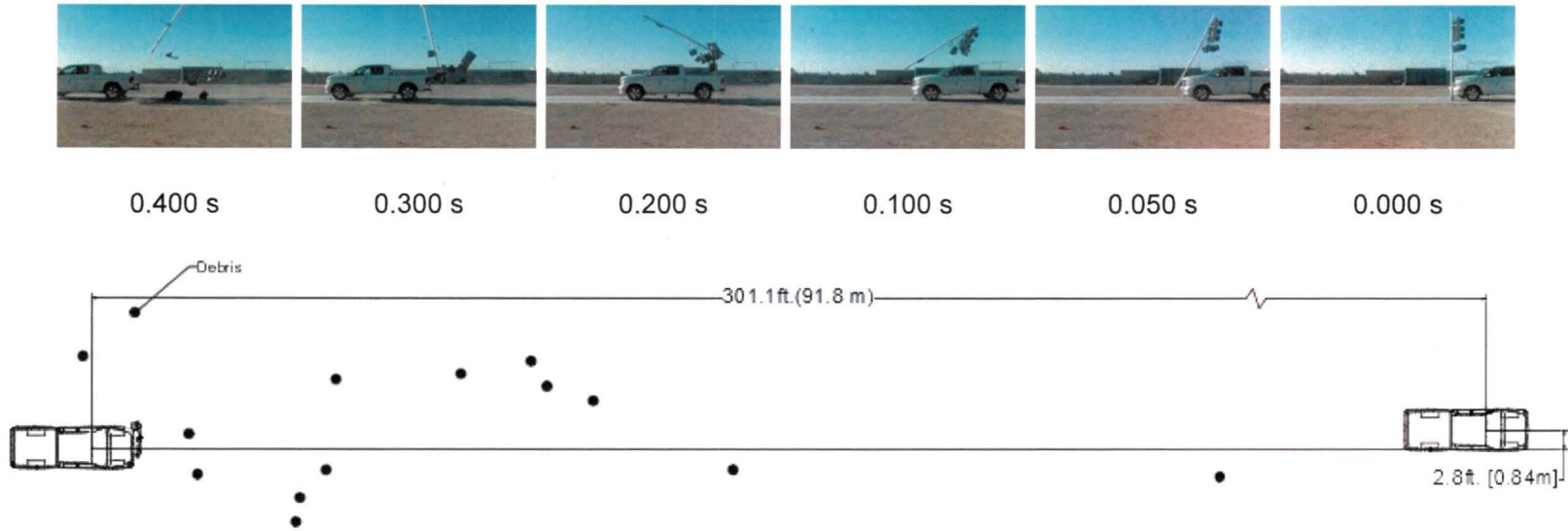

<b>GENERAL INFORMATION</b>	
Test Agency.....	KARCO Engineering, LLC.
KARCO Test No.....	P38168-03
Test Designation.....	3-62
Test Date.....	06/28/18
<b>TEST ARTICLE</b>	
Name / Model.....	Pedestrian Signal Pole
Type.....	Support Structure
Device Height .....	14.8 ft. (4.5 m)
Key Elements.....	Support and Pedestal
Road Surface.....	Concrete
<b>TEST VEHICLE</b>	
Type / Designation.....	2270P
Year, Make, and Model....	2012 RAM 1500
Curb Mass.....	5,025.4 lbs (2,279.5 kg)
Test Inertial Mass.....	5,060.6 lbs (2,295.5 kg)
Gross Static Mass.....	5,060.6 lbs (2,295.5 kg)

<b>Impact Conditions</b>	
Impact Velocity.....	60.34 mph (97.10 km/h)
Impact Angle.....	0.0°
Location / Orientation.....	Offset towards driver side
Kinetic	615.8 kip-ft (835.0 kJ)
<b>Exit Conditions</b>	
Exit Velocity.....	59.13 mph (95.17 km/h)
Exit Angle.....	0.0°
Final Vehicle	301.1 ft. (91.8 m ) dw
	2.8 ft. (0.9 m) left
Exit Box Criteria Met.....	N/A
Vehicle Snagging.....	None
Vehicle Pocketing.....	None
Maximum Roll Angle.....	2.8 °
Maximum Pitch Angle.....	0.9 °
Maximum Yaw Angle.....	-4.0 °

<b>Occupant Risk</b>	
Longitudinal OIV.....	N/A
Lateral OIV.....	N/A
Longitudinal RA.....	N/A
Lateral RA.....	N/A
THIV.....	N/A
PHD.....	N/A
ASI.....	N/A
<b>Test Article Deflections</b>	
Debris Field (longitudinal) ...	161.1 ft. (49.1 m)
Debris Field (lateral).....	18.9 ft. (5.8 m)
<b>Vehicle Damage</b>	
Vehicle Damage Scale.....	12-FL-2
CDC.....	12FLDW1
Maximum Intrusion.....	No measureable

Figure 2 Test 3-62 Summary



- 15' PIPE 15'-9 1/2"± HIGH
- 14' PIPE 14'-9 1/2"± HIGH
- 13' PIPE 13'-9 1/2"± HIGH
- 12' PIPE 12'-9 1/2"± HIGH
- 11' PIPE 11'-9 1/2"± HIGH
- 10' PIPE 10'-9 1/2"± HIGH
- 9' PIPE 9'-9 1/2"± HIGH
- 8' PIPE 8'-9 1/2"± HIGH
- 7' PIPE 7'-9 1/2"± HIGH
- 6' PIPE 6'-9 1/2"± HIGH
- 5' PIPE 5'-9 1/2"± HIGH
- 4' PIPE 4'-9 1/2"± HIGH

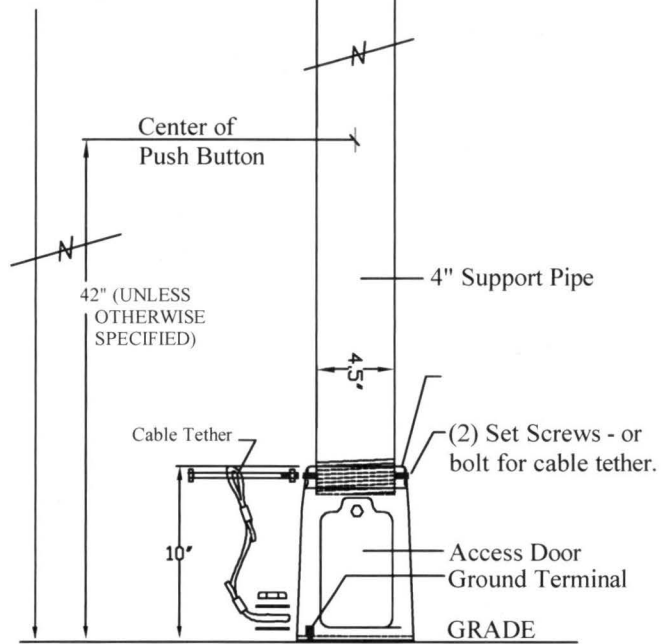

CROSSWALK - SIGNAL PEDESTAL ASSEMBLY

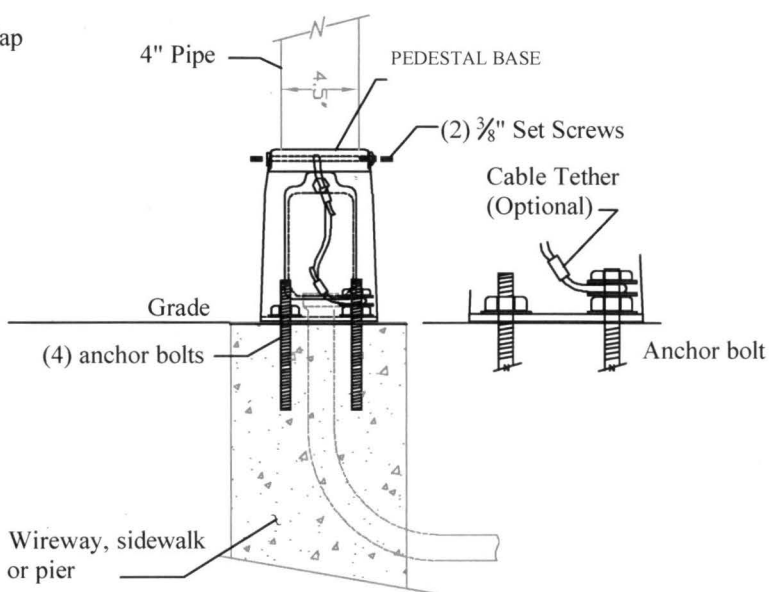

BASE MOUNTING

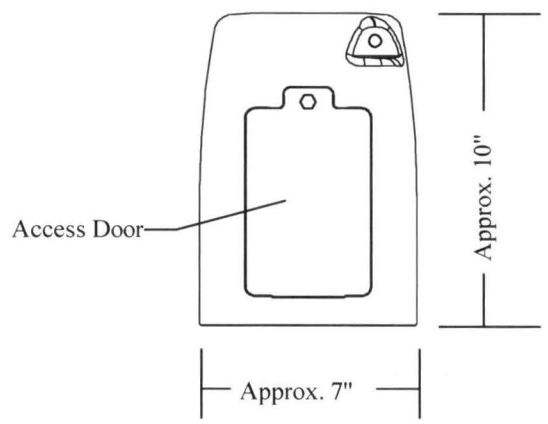

BASE SIDE VIEW

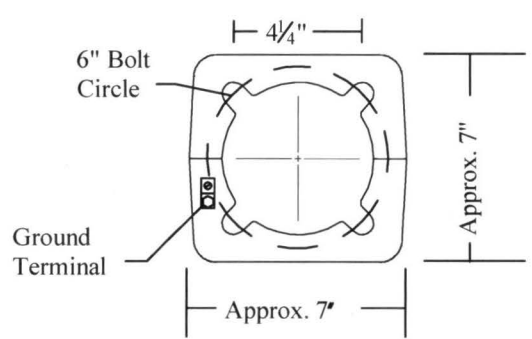

BASE BOTTOM VIEW

NOT TO SCALE

HARDWARE MEETS OR EXCEEDS STATE SPECIFICATIONS

**FREY**  
 Manufacturing Corp.  
 www.FreyMfgCorp.com  
 Patent 9493918  
 Made in USA  
 Phone: 952-467-4402

**CROSSWALK - SIGNAL PEDESTAL HEIGHTS**  
**FOR**  
 VARIOUS LENGTHS OF 4" PIPES  
 CATALOG #: CP6 SERIES

DATE	DWG. NO.	REV.
04-19-18	<b>8.5.0</b>	<b>1</b>