



U.S. Department of Transportation
**Federal Highway
Administration**



QUADRANT ROADWAY INTERSECTION Informational Guide

January 2020

U.S. Department of Transportation
Federal Highway Administration Office of Safety
1200 New Jersey Ave., SE
Washington, DC 20590

FOREWORD

The Federal Highway Administration (FHWA) Every Day Counts (EDC) initiative is designed to identify and deploy innovation aimed at reducing project delivery time, enhancing safety and protecting the environment. In 2012, FHWA chose Intersection & Interchange Geometrics (IIG) to feature as one of the innovative technologies in the second round of EDC. Specifically, IIG consists of a family of alternative intersection designs that improve intersection safety while also reducing delay, lowering costs, and lessening impacts compared to traditional solutions.

As part of the effort to mainstream these intersections, FHWA produced a series of informational guides to help transportation professionals routinely consider and implement these designs. During EDC2, FHWA developed and published guides for four designs: the Median U-Turn (MUT), Restricted Crossing U-turn (RCUT), Displaced Left Turn (DLT), and Diverging Diamond Interchange (DDI). This Quadrant Roadway (QR) Intersection Informational Guide is now the fifth in the series, and is intended to inform project planning, scoping, design and implementation decisions for QR intersections.

An electronic version of this document is available on the Office of Safety website at <http://safety.fhwa.dot.gov/>. Additionally, limited quantities of hard copies are available from the Report Center; inquiries may be directed to report.center@dot.gov or 814-239-1160.



Michael S. Griffith
Director
Office of Safety Technologies

Notice

This document is disseminated under the sponsorship of the U.S. Department of Transportation in the interest of information exchange. The U.S. Government assumes no liability for the use of the information contained in this document. This report does not constitute a standard, specification, or regulation.

The U.S. Government does not endorse products or manufacturers. Trademarks or manufacturers' names appear in this report only because they are considered essential to the objective of the document.

Quality Assurance Statement

The Federal Highway Administration (FHWA) provides high-quality information to serve Government, industry, and the public in a manner that promotes public understanding. Standards and policies are used to ensure and maximize the quality, objectivity, utility, and integrity of its information. FHWA periodically reviews quality issues and adjusts its programs and processes to ensure continuous quality improvement.

Technical Report Documentation Page

<p>1. Report No. FHWA-SA-19-029</p>	<p>2. Government Accession No.</p>	<p>3. Recipient's Catalog No.</p>	
<p>4. Title and Subtitle Quadrant Roadway Intersection Informational Guide</p>		<p>5. Report Date January 2020</p>	
		<p>6. Performing Organization Code</p>	
<p>7. Authors Jonathan D. Reid; Joseph E. Hummer</p>		<p>8. Performing Organization Report No. Project 13517</p>	
<p>9. Performing Organizations Name and Address Arcadis VHB 5420 Wade Park Drive, Suite 350 940 Main Campus Drive #500 Raleigh, North Carolina 27609 Raleigh, NC 27606</p>		<p>10. Work Unit No. (TRIS)</p>	
		<p>11. Contract or Grant No. TO DTFH61-00023-T-13002</p>	
<p>12. Sponsoring Agency Name and Address U.S. Department of Transportation Federal Highway Administration Office of Safety 1200 New Jersey Ave., SE Washington, DC 20590</p>		<p>13. Type of Report and Period Technical Report / Informational Report November 2018 to December 2019</p>	
		<p>14. Sponsoring Agency Code FHWA</p>	
<p>15. Supplementary Notes Jeffrey Shaw (jeffrey.shaw@dot.gov), Office of Safety Technologies (http://safety.fhwa.dot.gov/), served as the Technical Manager for the Federal Highway Administration (FHWA). The following FHWA staff contributed as technical working group members, reviewers and/or provided input or feedback to the project at various stages: Dr. Wei Zhang, Mark Doctor, Tim Taylor, Dave Petrucci and Dr. Hillary Isebrands. Dr. Joseph Hummer (jehummer@ncdot.org), North Carolina Department of Transportation (NCDOT) State Traffic Management Engineer, served as Document Technical Manager. The following NCDOT staff contributed as technical working group members, reviewers, and/or provided input or feedback to the project at various stages: Jason Moore, Jason Galloway, Hanna Cockburn, and Renee Roach. Other contributors included: Brian Fowler, City of Norfolk, VA.</p>			
<p>16. Abstract This document provides information and guidance on Quadrant Roadway (QR) intersections, resulting in designs suitable for a variety of typical conditions commonly found in the U.S. To the extent possible, the guide addresses a variety of conditions found in the U.S., to achieve designs suitable for a wide array of potential users. This guide provides general information, planning techniques, evaluation procedures for assessing safety and operational performance, design guidelines, and principles to be considered for selecting, planning, designing, and implementing QR intersections.</p>			
<p>17. Key Words QR Intersection, Quadrant Roadway, Quadrant Left, Alternative Intersection, Innovative Intersection, Reduced Conflict Intersection</p>		<p>18. Distribution Statement No restrictions.</p>	
<p>19. Security Classif. (of this report) Unclassified</p>	<p>20. Security Classif. (of this page) Unclassified</p>	<p>21. No. of Pages 180</p>	<p>22. Price</p>

SI* (MODERN METRIC) CONVERSION FACTORS				
APPROXIMATE CONVERSIONS TO SI UNITS				
Symbol	When You Know	Multiply By	To Find	Symbol
LENGTH				
in	inches	25.4	millimeters	mm
ft	feet	0.305	meters	m
yd	yards	0.914	meters	m
mi	miles	1.61	kilometers	km
AREA				
in ²	square inches	645.2	square millimeters	mm ²
ft ²	square feet	0.093	square meters	m ²
yd ²	square yard	0.836	square meters	m ²
ac	acres	0.405	hectares	ha
mi ²	square miles	2.59	square kilometers	km ²
VOLUME				
fl oz	fluid ounces	29.57	milliliters	mL
gal	gallons	3.785	liters	L
ft ³	cubic feet	0.028	cubic meters	m ³
yd ³	cubic yards	0.765	cubic meters	m ³
NOTE: volumes greater than 1000 L shall be shown in m ³				
MASS				
oz	ounces	28.35	grams	g
lb	pounds	0.454	kilograms	kg
T	short tons (2000 lb)	0.907	megagrams (or "metric ton")	Mg (or "t")
TEMPERATURE (exact degrees)				
°F	Fahrenheit	5 (F-32)/9 or (F-32)/1.8	Celsius	°C
ILLUMINATION				
fc	foot-candles	10.76	lux	lx
fl	foot-Lamberts	3.426	candela/m ²	cd/m ²
FORCE and PRESSURE or STRESS				
lbf	poundforce	4.45	newtons	N
lbf/in ²	poundforce per square inch	6.89	kilopascals	kPa
APPROXIMATE CONVERSIONS FROM SI UNITS				
Symbol	When You Know	Multiply By	To Find	Symbol
LENGTH				
mm	millimeters	0.039	inches	in
m	meters	3.28	feet	ft
m	meters	1.09	yards	yd
km	kilometers	0.621	miles	mi
AREA				
mm ²	square millimeters	0.0016	square inches	in ²
m ²	square meters	10.764	square feet	ft ²
m ²	square meters	1.195	square yards	yd ²
ha	hectares	2.47	acres	ac
km ²	square kilometers	0.386	square miles	mi ²
VOLUME				
mL	milliliters	0.034	fluid ounces	fl oz
L	liters	0.264	gallons	gal
m ³	cubic meters	35.314	cubic feet	ft ³
m ³	cubic meters	1.307	cubic yards	yd ³
MASS				
g	grams	0.035	ounces	oz
kg	kilograms	2.202	pounds	lb
Mg (or "t")	megagrams (or "metric ton")	1.103	short tons (2000 lb)	T
TEMPERATURE (exact degrees)				
°C	Celsius	1.8C+32	Fahrenheit	°F
ILLUMINATION				
lx	lux	0.0929	foot-candles	fc
cd/m ²	candela/m ²	0.2919	foot-Lamberts	fl
FORCE and PRESSURE or STRESS				
N	newtons	0.225	poundforce	lbf
kPa	kilopascals	0.145	poundforce per square inch	lbf/in ²

*SI is the symbol for the International System of Units. Appropriate rounding should be made to comply with Section 4 of ASTM E380. (Revised March 2003)

TABLE OF CONTENTS

CHAPTER 1 — INTRODUCTION 1

 OVERVIEW OF ALTERNATIVE INTERSECTIONS AND INTERCHANGES 1

 INTERSECTION CONTROL EVALUATIONS AND CONSIDERATIONS 1

 ORGANIZATION OF THE GUIDE..... 2

 SCOPE OF THE GUIDE..... 3

 QUADRANT ROADWAY INTERSECTION OVERVIEW 3

 QUADRANT ROADWAY APPLICATIONS..... 6

 GEOMETRIC DESIGN CONSIDERATIONS..... 9

 RESOURCE DOCUMENTS..... 21

CHAPTER 2 — POLICY AND PLANNING 23

 PLANNING CONSIDERATIONS FOR ALTERNATIVE INTERSECTIONS 23

 STAKEHOLDER OUTREACH..... 27

 POLICY CONSIDERATIONS 30

 PLANNING CONSIDERATIONS 31

 PLANNING CHALLENGES..... 31

 PROJECT PERFORMANCE CONSIDERATIONS 32

 PROJECT DEVELOPMENT PROCESS..... 33

 SUMMARY OF QR INTERSECTION ADVANTAGES AND DISADVANTAGES..... 34

CHAPTER 3 — MULTIMODAL CONSIDERATIONS..... 37

 DESIGN PRINCIPLES AND APPROACH 37

 PEDESTRIANS..... 39

 BICYCLISTS..... 45

 TRANSIT VEHICLE CONSIDERATION 51

 HEAVY VEHICLE CONSIDERATIONS..... 53

CHAPTER 4 — SAFETY 55

 SAFETY PRINCIPLES 55

 SAFETY CONCERNS 61

 INCIDENT RESPONSE CONSIDERATIONS 65

 OBSERVED SAFETY PERFORMANCE..... 65

 SUMMARY OF SAFETY EVALUATION CONSIDERATIONS 68

CHAPTER 5 — OPERATIONAL CHARACTERISTICS 69

 OPERATIONAL CONSIDERATIONS..... 70

 SIGNAL CYCLE LENGTHS, PHASING AND COORDINATION 79

THROUGHPUT AND FLOW RATES.....	84
COMPARATIVE PERFORMANCE STUDIES AND LITERATURE REVIEWS.....	85
CHAPTER 6 — OPERATIONAL ANALYSIS.....	93
OPERATIONAL ANALYSIS TOOL OVERVIEW.....	94
PLANNING-LEVEL ANALYSIS.....	96
HIGHWAY CAPACITY ANALYSIS ANALYSIS.....	100
MICROSIMULATION ANALYSIS.....	104
SUMMARY.....	105
CHAPTER 7 — GEOMETRIC DESIGN.....	107
DESIGN APPROACH.....	107
GEOMETRIC DESIGN PRINCIPLES.....	108
GEOMETRIC DESIGN PARAMETERS.....	108
OPERATIONAL EFFECTS OF GEOMETRIC DESIGN.....	113
DESIGN GUIDANCE.....	120
CHAPTER 8 — SIGNAL, MARKING, SIGNS, AND LIGHTING CONSIDERATIONS.....	123
DESIGN PRINCIPLES AND APPROACH.....	123
SIGNALS.....	123
SIGNING.....	128
PAVEMENT MARKING.....	136
CHAPTER 9 — CONSTRUCTION AND MAINTENANCE.....	137
CONSTRUCTION.....	137
COSTS.....	139
MAINTENANCE.....	140
LAW ENFORCEMENT.....	143
APPENDIX A – CATALOG OF KNOWN INSTALLATIONS IN THE U.S.	145
Intersection Profile 1: SR-4 at SR-4 bypass, Fairfield, OH.....	146
Intersection Profile 2: NC-73 at US-21, Huntersville, NC.....	148
Intersection Profile 3: US-340/522 at SR-55, Front Royal, VA.....	150
Intersection Profile 4: US-42 at KY-872, Florence, KY.....	152
Intersection Profile 5: US-220 at Church St, Greensboro, NC.....	153
Intersection Profile 6: Market St at Kerr Ave, Wilmington, NC.....	154
APPENDIX B – MARKETING / OUTREACH MATERIALS.....	157
APPENDIX C – ARTICLES, PAPERS, AND PUBLICATIONS.....	161
ACKNOWLEDGEMENTS.....	163
REFERENCES.....	165

LIST OF FIGURES

Figure 1. Graphic. Key characteristics of a QR intersection. 3

Figure 2. Graphic. QR intersection left-turn patterns from D Street. 4

Figure 3. Graphic. QR intersection left-turn patterns from A Street. 4

Figure 4. Graphic. Locations of QR intersections in the U.S. 6

Figure 5. Photo. SR-4 / SR-4 Bypass QR intersection, Fairfield, Ohio..... 7

Figure 6. Photo. NC-73 / US-21 Partial QR intersection, Huntersville, North Carolina.⁽²⁾..... 7

Figure 7. Photo. US-340/522 / SR-55 QR intersection, Front Royal, Virginia. Provided by Virginia Department of Transportation. 8

Figure 8. Photo. US-42 / KY-872 QR intersection, Florence, Kentucky. 8

Figure 9. Graphic. QR intersection evolution: initial quadrant roadway..... 10

Figure 10. Graphic. QR intersection evolution: coordinated signal operations..... 11

Figure 11. Graphic. QR intersection evolution: final configuration. 11

Figure 12. Graphic. Rendering of QR in urban area. 12

Figure 13. Graphic. Conventional intersection with double left-turn lanes..... 13

Figure 14. Graphic. QR intersection facilitation of Complete Street development..... 13

Figure 15. Graphic. QR intersection with secondary T-intersection roundabout. 15

Figure 16. Photo. QR intersection with access to inscribed land uses..... 15

Figure 17. Photo. Imbalanced lanes on partial QR intersection. 16

Figure 18. Photo. Dual Quadrant intersection (Bend, Oregon).⁽⁴⁾ 17

Figure 19. Photo. Four-Quadrant intersection (Alpharetta, Georgia).⁽⁵⁾ 18

Figure 20. Photo. Grade-separated QR intersection (Owens Mill, Maryland).⁽⁶⁾ 19

Figure 21. Photo. Hybrid QR / Median U-Turn (Bloomfield Hills, Michigan).⁽⁷⁾ 20

Figure 22. Graphic. Relationship between traffic volume served and intersection type. 25

Figure 23. Graphic. QR intersection footprint compared to a conventional intersection. 26

Figure 24. Graphic. Screenshot from video describing movement paths for QR project..... 28

Figure 25. Graphic. Screenshot from QR intersection informational video. Provided by Virginia Department of Transportation..... 28

Figure 26. Graphic. QR intersection microsimulation video..... 29

Figure 27. Graphic. Enhanced project video using microsimulation data..... 29

Figure 28. Graphic. Project development process. 33

Figure 29. Graphic. Multimodal considerations. 38

Figure 30. Graphic. Pedestrian-vehicle conflict points at a conventional intersection..... 40

Figure 31. Graphic. Pedestrian-vehicle conflict points at QR intersection..... 40

Figure 32. Graphic. Pedestrian movements through a QR intersection..... 41

Figure 33. Graphic. Conventional intersection crosswalk distances.	42
Figure 34. Graphic. QR intersection crosswalk distances.	42
Figure 35. Graphic. Pedestrian walk phases at a conventional intersection.	43
Figure 36. Graphic. Pedestrian walk phases at a QR intersection.	43
Figure 37. Photo. Example of pedestrian wayfinding provision via curbing.	45
Figure 38. Photo. Bike lanes at Front Royal QR intersection.....	46
Figure 39. Graphic. Right-turn lane with bicycle lane.....	46
Figure 40. Graphic. Bicycle two-stage crossing path.	47
Figure 41. Graphic. Bicycle in-pavement bike box.	48
Figure 42. Graphic. D Street bicyclists left turns following quadrant roadway.	49
Figure 43. Graphic. A Street bicyclists left turns following quadrant roadway.	50
Figure 44. Graphic. Desirable QR intersection rail crossings.	51
Figure 45. Graphic. Less desirable QR intersection rail crossings.	51
Figure 46. Graphic. Potential bus stop locations.	53
Figure 47. Graphic. Vehicle-vehicle conflict points at conventional intersection.....	56
Figure 48. Graphic. Vehicle-vehicle conflict points at QR intersection.....	57
Figure 49. Graphic. QR intersection MT-QL-QR pattern.	58
Figure 50. Graphic. QR intersection QL-QL pattern.....	58
Figure 51. Graphic. QR intersection QR-QL-MT pattern.	59
Figure 52. Graphic. QR intersection MT-QR-QR-MT pattern.....	59
Figure 53. Graphic. Hybrid QR intersection with U-turn at secondary T-intersection.	61
Figure 54. Photo. Traffic camera capture of illegal turns at QR intersection.....	62
Figure 55. Equation. Calculation of safe stopping distance.....	62
Figure 56. Graphic. QR intersection braking distances.	63
Figure 57. Graphic. Queue storage areas of concern.	64
Figure 58. Graphic. Conventional versus QR left turn movements: D Street.	69
Figure 59. Graphic. Conventional versus QR left turn: A Street.....	69
Figure 60. Graphic. QR intersection access impacts.	71
Figure 61. Graphic. QR RIRO access management recommendations.....	73
Figure 62. Graphic. QR directional access management recommendations.	73
Figure 63. Graphic. Directional vehicle paths w/RIRO access on quadrant roadway.....	74
Figure 64. Graphic. Directional vehicle paths w/directional access on quadrant roadway.	75
Figure 65. Graphic. Additional QR left-turn travel distances at 500-ft spacing.....	76
Figure 66. Graphic. Additional QR left-turn travel distances at 800-ft spacing.....	76

Figure 67. Graphic. 150-second conventional intersection multi-phase signal splits.....	79
Figure 68. Graphic. 90-second QR main intersection signal splits.....	80
Figure 69. Graphic. 90-second QR secondary-T intersection signal splits.....	80
Figure 70. Chart. Comparison of movement green times.	81
Figure 71. Graphic. QR intersection signal phasing.	82
Figure 72. Graphic. QR intersection time-space diagram.....	83
Figure 73. Graphic. Lane continuity through QR left-turn movement.	85
Figure 74. Graphic. Throughput comparison of QR versus conventional intersection.	90
Figure 75. Graphic. Translating turn movements from conventional to a QR intersection.....	95
Figure 76. Graphic. Converting conventional to QR intersection volumes.....	96
Figure 77. Graphic. CAP-X planning level tool screen capture for QR intersection.	99
Figure 78. Graphic. HCM method for QR evaluation.	102
Figure 79. Graphic. QR intersection characteristics.	107
Figure 80. Graphic. QR intersection geometric design (DS=30mph).	109
Figure 81. Graphic. QR intersection geometric design (DS=35mph).	109
Figure 82. Graphic. Two-lane quadrant roadway.	110
Figure 83. Graphic. Four-lane quadrant roadway.	110
Figure 84. Graphic. Six-lane quadrant roadway.	111
Figure 85. Photo. Use of parcel inside quadrant roadway for bio retention pond.	113
Figure 86. Graphic. Preferred secondary T-intersection geometry.....	114
Figure 87. Graphic. Secondary T-intersection geometry to avoid.....	114
Figure 88. Graphic. Secondary T-intersection compromise 1.	115
Figure 89. Graphic. Secondary T-intersection compromise 2.	115
Figure 90. Graphic. Secondary T-intersection compromise 3.	116
Figure 91. Graphic. Secondary T-intersection compromise 4.	116
Figure 92. Graphic. Huntersville QR intersection access lessons learned.....	117
Figure 93. Graphic. Preferred quadrants at skewed intersections.....	118
Figure 94. Graphic. Undesirable quadrants at skewed intersections.	118
Figure 95. Graphic. Types of channelized turns (1). ⁽²¹⁾	119
Figure 96. Graphic. Types of channelized turns (2). ⁽²¹⁾	119
Figure 97. Graphic. Pedestrian crosswalk placements.....	120
Figure 98. Graphic. Main intersection design guidance.	121
Figure 99. Graphic. Fairfield median lessons learned.	122
Figure 100. Graphic. Typical mast arm pole, signal head, and cabinet placement.	124

Figure 101. Graphic. Detector placements.	127
Figure 102. Photo. QR intersection regulatory signing, Fairfield, Ohio.....	129
Figure 103. Photo. QR intersection regulatory signing, Front Royal, Virginia.....	129
Figure 104. Photo. QR intersection regulatory signing, Huntersville, North Carolina.	129
Figure 105. Graphic. Typical QR intersection signing plan for juncture of two U.S. routes.	130
Figure 106. Graphic. Typical QR intersection signing plan for juncture of State/local route....	131
Figure 107. Graphic. QR intersection overhead signing plan for westbound NC-73.....	132
Figure 108. Graphic. QR intersection overhead signing plan for eastbound NC-73.....	132
Figure 109. Photo. Examples of QR overhead signing, Hunstersville, North Carolina.	133
Figure 110. Photo. Examples of QR overhead signing, Front Royal, Virginia.	133
Figure 111. Photo. Examples of QR overhead signing, Fairfield, Ohio.	133
Figure 112. Photo. Route wayfinding signs on Front Royal quadrant roadway.....	134
Figure 113. Photo. Services wayfinding signs on Huntersville quadrant roadway.	134
Figure 114. Graphic. MUTCD signing for left-turn bike boxes. ⁽¹⁰⁾	135
Figure 115. Photo. Local example of bike box signing.	135
Figure 116. Photo. Directional shield pavement marking, Huntersville, North Carolina.	136
Figure 117. Photo. Directional shield pavement marking, Front Royal, Ohio.	136
Figure 118. Graphic. Front Royal construction maintenance of traffic lessons learned. Provided by Virginia Department of Transportation.	142
Figure 119. Photo. SR-4 at SR-4 Bypass, Fairfield, Ohio.	146
Figure 120. Photo. NC-73 at US-21, Huntersville, North Carolina.....	148
Figure 121. Photo. US-340/522 at SR-55, Front Royal, Virginia. Provided by Virginia Department of Transportation.....	150
Figure 122. Photo. US-42 at KY-872, Florence, Kentucky.....	152
Figure 123. Photo. US-220 at Church St. Greensboro, North Carolina.....	153
Figure 124. Photo. Market Street at Kerr Avenue, Wilmington, North Carolina.....	155
Figure 125. Graphic. FHWA innovative intersection (RCUT) video.....	157
Figure 126. Graphic. FHWA innovative intersection informational drive-through video.	157
Figure 127. Graphic. Example of QR intersection video developed for Front Royal project. ...	158
Figure 128. Graphic. Example of QR intersection video developed for Huntersville project....	158

LIST OF TABLES

Table 1. Comparison of QR intersection. 9

Table 2. Alternative intersection and interchange types used in the U.S. 24

Table 3. Summary of QR intersection advantages and disadvantages. 35

Table 4. Conflict point comparison. 57

Table 5. Minimum intersection spacing by stopping sight distance. 63

Table 6. Three-year crash data comparison at Fairfield QR intersection. 66

Table 7. Three-year crash data comparison at Huntersville QR intersection. 67

Table 8. One-year crash data comparison at Front Royal QR intersection. 67

Table 9. Additional QR left-turn travel distances: Street C-D spacing = 400 ft. 77

Table 10. Additional QR left-turn travel distances: Street C-D spacing = 500 ft. 77

Table 11. Additional QR left-turn travel distances: Street C-D spacing = 600 ft. 77

Table 12. Additional QR left-turn travel distances: Street C-D spacing = 700 ft. 77

Table 13. Additional QR left-turn travel distances: Street C-D spacing = 800 ft. 77

Table 14. Storage bay and taper length guidance. 78

Table 15. Summary of comparison literature and performance studies. 86

Table 16. Summary of ITE study results. 87

Table 17. TRB study intersection evaluated. 88

Table 18. Summary of TRB study results.⁽²⁷⁾ 89

Table 19. QR intersection analysis techniques. 94

Table 20. V/C correlation to LOS. 97

Table 21. CLV capacity by number of signal phases. 97

Table 22. Conventional and QR intersection critical lane capacity analysis. 98

Table 23. LOS criteria for signalized intersections.⁽⁹⁾ 101

Table 24. Input data for HCM evaluation of QR. 103

Table 25. Best use of analysis tools. 105

Table 26. Considerations for one versus three controllers at a QR intersection. 125

Table 27. Summary of costs associated with QR intersections. 140

Table 28. Full, partial, and hybrid QR intersections in the U.S. 145

LIST OF ABBREVIATIONS

AASHTO	American Association of State Highway and Transportation Officials
ACEC	American Civil Engineering Council
ADA	Americans with Disabilities Act
ADT	average daily traffic
AIIR	Alternative Intersections and Interchanges Informational Report
BRT	bus rapid transit
CAP-X	Capacity Analysis for Planning of Junctions
CL	cycle length
CLV	critical lane volume
DDI	Diverging Diamond Interchange
DLT	Displaced Left Turn
DS	Design Speed
EDC	Every Day Counts
FHWA	Federal Highway Administration
HCM	Highway Capacity Manual
HSM	Highway Safety Manual
ICE	Intersection Control Evaluation
ITE	Institute of Transportation Engineers
ITS	Intelligent Transportation System
KYTC	Kentucky Transportation Cabinet
LOS	level-of-service
LRT	light rail transit
MMLOS	multimodal level-of-service
MOEs	measures of effectiveness
MUT	Median U-Turn
MUTCD	Manual on Uniform Traffic Control Devices
NCDOT	North Carolina Department of Transportation
NCHRP	National Cooperative Highway Research Program
O-D	origin-destination
ODOT	Ohio Department of Transportation
OSOW	over-size / over-weight
PROWAG	Public Rights-of-Way Accessibility Guidelines
QR	Quadrant Roadway
RCUT	Restricted Crossing U-Turn
RIRO	right-in/right-out
ROW	right-of-way
RTOR	right-turn-on-red
TRB	Transportation Research Board
TTST	Tractor Trailer / Semi Truck
V/C	volume-to-capacity
VDOT	Virginia Department of Transportation
VPHPL	vehicles-per-hour-per-lane
Y/AR	yellow and all-red

CHAPTER 1 — INTRODUCTION

OVERVIEW OF ALTERNATIVE INTERSECTIONS AND INTERCHANGES

Alternative intersections and interchanges offer the potential to improve safety and reduce delay at a lower cost and with fewer impacts than traditional solutions. However, transportation professionals may be unfamiliar with many alternative intersection and interchange forms, partially because some forms have only a few installations in operation or because installations are concentrated in a few States. Furthermore, at the national level, well-documented and substantive resources needed for planning, analysis, design, public outreach, and education have been limited.

Previous to this Quadrant Roadway Informational Guide, the Federal Highway Administration (FHWA) developed and published informational guides in 2014 for four alternative intersection and interchange forms: the Median U-Turn (MUT), Displaced Left Turn (DLT), Restricted Crossing U-Turn (RCUT), and Diverging Diamond Interchange (DDI). The guides have increased awareness of these specific alternative intersections and provide guidance on how to plan, design, construct, and operate them. Collectively, these guides represent summaries of the current state of knowledge with the intent of supporting decisions when considering and potentially selecting alternative intersection and interchange forms for appropriate applications.

INTERSECTION CONTROL EVALUATIONS AND CONSIDERATIONS

The term “intersection” means the junction of two or more street facilities. In some cases, this may specifically mean an “at-grade” intersection form. In others, it may include the junction of two or more streets requiring partial or complete grade separation (“interchanges”). A number of State and local transportation agencies have or are implementing intersection control evaluation (ICE) processes and/or policies as a means of integrating the widest range of intersection forms as project solutions.

Many ICE policies or processes include common objectives in selecting the optimal or preferred intersection control alternative for a given project context. The common elements generally include, but are not limited to, the following:

- Understanding how operations, safety, and geometry fit the context for each intersection or corridor for intended users including pedestrians, bicyclists, passenger cars, transit vehicles, freight, emergency responders, and over size/over weight (OSOW) vehicles.
- Identifying and documenting the overall corridor or intersection context including the built, natural, and community environment and the intended performance.
- Considering and assessing a wide range of traffic control strategies and other practical improvement concepts to identify necessary project-level technical evaluation.
- Comparing engineering and economic analysis results of practical alternatives that consider implementation costs, performance benefits and impacts (safety, multimodal, operations, environment, etc.), and the estimated service life of alternatives.

ORGANIZATION OF THE GUIDE

This guide is structured to address the needs of a variety of readers, including the general public, policy makers, transportation planners, operations and safety analysts, and conceptual and detailed designers regarding quadrant roadway (QR) intersections. This section provides an overview of each chapter in this guide and distinguishes QR intersections from conventional intersections. The remaining chapters in this guide increase the level of detail provided.

Chapter 2: Policy and Planning – This chapter provides guidance on when to consider alternative intersections in general and QR intersections in particular. Considerations related to policies, project challenges, performance measures, and the project development process throughout the duration of the project are presented.

Chapter 3: Multimodal Considerations – This chapter provides an overview of multimodal facilities at QR intersections and how the needs of various users should inform decisions to produce a facility that optimally serves motorized and non-motorized traffic.

Chapter 4: Safety – This chapter summarizes documented safety performance and safety considerations at QR intersections based on studies completed by State agencies and recent research efforts. Although the documented safety performance of QR intersections is limited, information about conflict points and emergency services at these intersections are discussed.

Chapter 5: Operational Characteristics – This chapter provides information on the unique operational characteristics of QR intersections and how they affect elements such as traffic signal phasing and coordination. The chapter also provides guidance for practitioners related to design elements such as the location of the quadrant roadway, access management, and intersection spacing that may affect the operational performance of QR intersections. It describes unique operational characteristics of QR intersections and prepares transportation professionals for conducting operational analysis as described in chapter 6.

Chapter 6: Operational Analysis – This chapter presents an overview of the approach and tools available for conducting a traffic operations analysis of a QR intersection.

Chapter 7: Geometric Design – This chapter describes the typical QR intersection design approach and provides guidance for geometric features. Design of a QR intersection will also require reviewing and integrating the intersection's multimodal considerations (chapter 3), safety assessment (chapter 4), and traffic operational analysis (chapters 5 and 6).

Chapter 8: Signal, Signing, Marking, and Lighting – This chapter presents information relating to the design and placement of traffic control devices at QR intersections, including traffic signals, signs, pavement markings, and intersection lighting.

Chapter 9: Construction and Maintenance – This chapter focuses on the constructability and maintenance of a QR intersection.

An Appendix is included at the end of this guide for the purpose of providing more detailed information about many of the resources and best practices relating to QR intersections. The Appendix contains the following information:

- A – Catalog of known installations in the U.S.
- B – Marketing and outreach materials.
- C – Articles, papers, and publications.

SCOPE OF THE GUIDE

This document provides information and guidance on planning and designing QR intersections, resulting in designs suitable for a variety of conditions commonly found in the U.S. To the extent possible, the guide provides information on how QR intersections can accommodate a wide variety of users. Developed from best practices and prior research, the scope of this guide is to provide general information, planning techniques, evaluation procedures for assessing safety and operational performance, design guidelines, and principles to be considered for selecting and designing QR intersections. This guide does not include specific legal or policy requirements. However, chapter 2 provides information on planning topics and considerations when investigating new intersection control forms. This first edition of the Quadrant Roadway Informational Guide has been developed from documented practices and prior research. As more QR intersections are built, there will be further opportunities to conduct research to refine existing and develop new methods to inform project decisions about this intersection form.

QUADRANT ROADWAY INTERSECTION OVERVIEW

The QR intersection is also known as the “Quadrant”, “Quadrant Left”, or “Single Quadrant” intersection. For the purposes of this informational guide, a QR intersection refers to any at-grade intersection of two roadways where left turns are displaced to a quarter-arc “quadrant roadway” in one intersection quadrant. This quadrant roadway can be constructed new or an existing road can be repurposed. Figure 1 depicts key characteristics of a typical QR intersection. While the figure depicts a roadway in the southwest quadrant with three signalized intersections, the roadway can be effectively located in any intersection quadrant, and while the main intersection is always signalized, the secondary T-intersections may or may not be signalized.

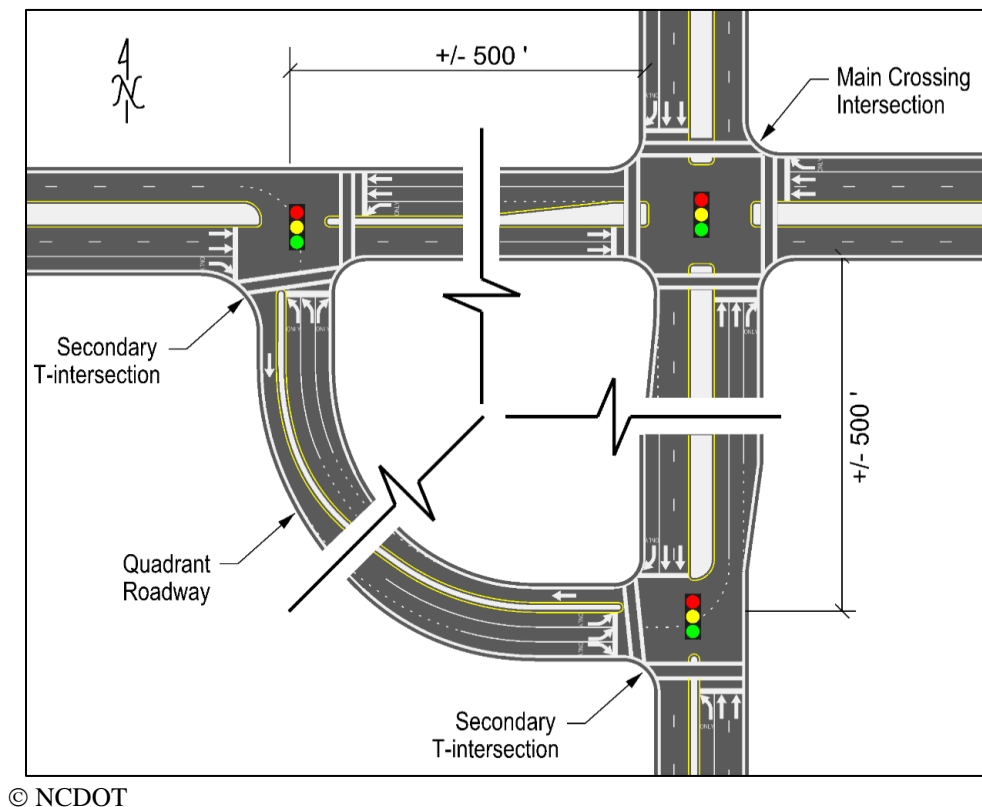
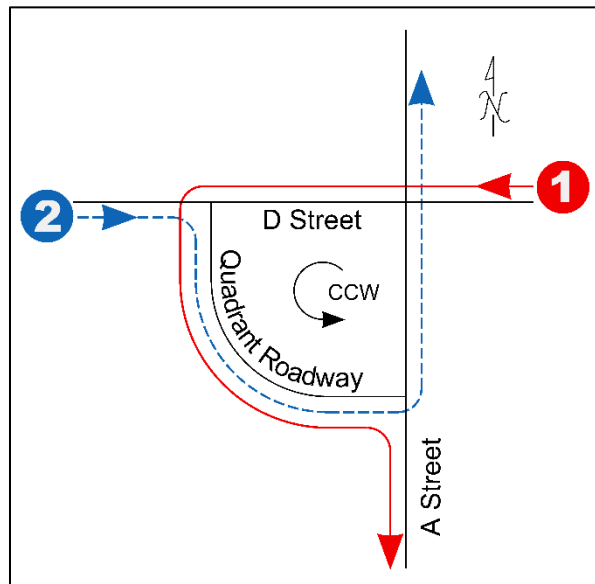

Figure 1. Graphic. Key characteristics of a QR intersection.

Under the QR intersection, all left-turn movements typically made directly at the main intersection are now displaced and made indirectly using the quadrant roadway. Each indirect left-turn pattern is different as illustrated in figure 2 and figure 3 below, which depict the quadrant roadway in the southwest intersection quadrant. In these figures and throughout the guide, the street that provides the left turn onto the quadrant roadway in *advance* of the main intersection is called “A Street”, and the street that provides the left turn onto the quadrant roadway *downstream* of the main intersection is called “D Street”. Figure 2 illustrates the indirect left-turn patterns from D Street, which both use the quadrant in a counterclockwise direction. Figure 3 illustrates the indirect left-turn patterns from A Street, which both use the quadrant in a clockwise direction.



© NCDOT

Figure 2. Graphic. QR intersection left-turn patterns from D Street.

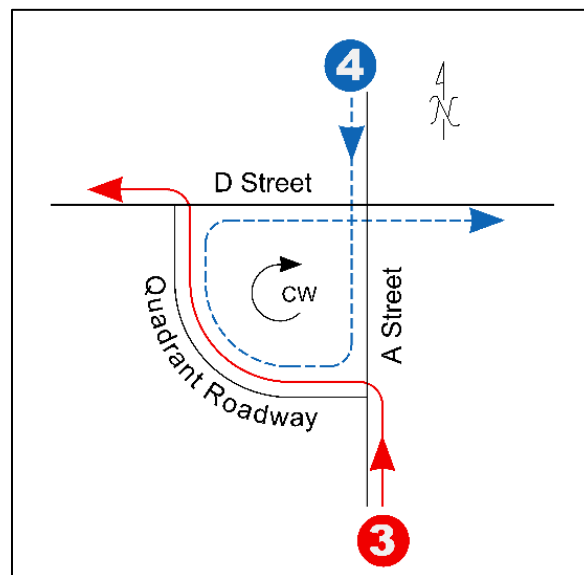

© NCDOT

Figure 3. Graphic. QR intersection left-turn patterns from A Street.

Each QR left-turn movement depicted in figure 2 and figure 3 is described below:

1. Vehicles westbound on D Street wanting to turn left onto A Street first pass through the main intersection, turn left onto the quadrant roadway, and turn right onto A Street.
2. Vehicles eastbound on D Street wanting to turn left onto A Street make a right turn onto the quadrant roadway in advance of the main intersection, turn left onto A Street, and pass northbound through the main intersection.
3. Vehicles northbound on A Street wanting to turn left onto D Street first turn left onto the quadrant roadway in advance of the main intersection and turn left again at the end of the quadrant roadway onto D Street, bypassing the main intersection altogether.
4. Vehicles southbound on A Street wanting to turn left onto D Street first pass through the main intersection, turn right onto the quadrant roadway, turn right again at the end of the quadrant roadway, and pass eastbound through the main intersection.

By eliminating left turns on both roadways at the main intersection, the QR intersection reduces the number of traffic signal phases and conflict points at the main intersection, resulting in improved intersection operations. At typical QR intersections, the secondary T-intersections at each end of the quadrant roadway are spaced approximately 500 ft from the main intersection, and access is fully controlled along the entirety of the quadrant roadway (i.e., no intermediate access to adjacent land uses).

History of the QR Intersection

Intersection designs that reroute one or more left-turn movements using connecting roadways have been used in some parts of the U.S. for decades. However, the formalization of rerouting all left turn-movements using a standardizing QR intersection was first proposed and published by Reid and Hummer in the Institute of Transportation Engineers (ITE) Journal in June 2000.⁽¹⁾ This version of a QR intersection was eventually planned and designed for NC-73 and US-21 in Huntersville, North Carolina, which opened in 2012.

Independent of the work by Reid and Hummer, the Ohio Department of Transportation (ODOT) developed a “diversion road” concept for the intersection of SR-4 / SR-4 Bypass in Fairfield, Ohio. The intersection design was a part of a larger SR-4 corridor improvement project that included RCUT (or superstreet) intersections. However, the superstreet concept could not adequately accommodate the balanced through volumes on both roadways at the SR-4 / SR-4 Bypass intersection, and the availability of land in one intersection quadrant gave ODOT the opportunity to develop the diversion road concept. Interestingly, ODOT only learned about the QR intersection research after the SR-4 project went to construction, though some of the research was helpful during the project media rollout phase. The SR-4 / SR-4 Bypass project opened in January 2012, making it the first QR intersection to open in the U.S.

QUADRANT ROADWAY APPLICATIONS

Though an emerging alternative intersection form, several QR and hybrid-QR intersections have been constructed throughout the U.S. Figure 4 shows the location of known QR, hybrid and partial QR, and multiple quadrant QR intersections in operation or under construction as of the publication of this guide. These intersections are also catalogued in Appendix A.

Figure 4 through figure 8 feature photos of the four most recent QR intersections open or currently under construction in the U.S. These intersection locations include:

- SR-4 at SR-4 Bypass, Fairfield, Ohio (suburb of Cincinnati); opened January 2012.
- US-21 at NC-73, Huntersville, North Carolina (suburb of Charlotte); opened March 2012.
- US-340/522 at SR-55, Front Royal, Virginia; opened December 2017.
- US-42 at KY-872, Florence, Kentucky; opened August 2019.

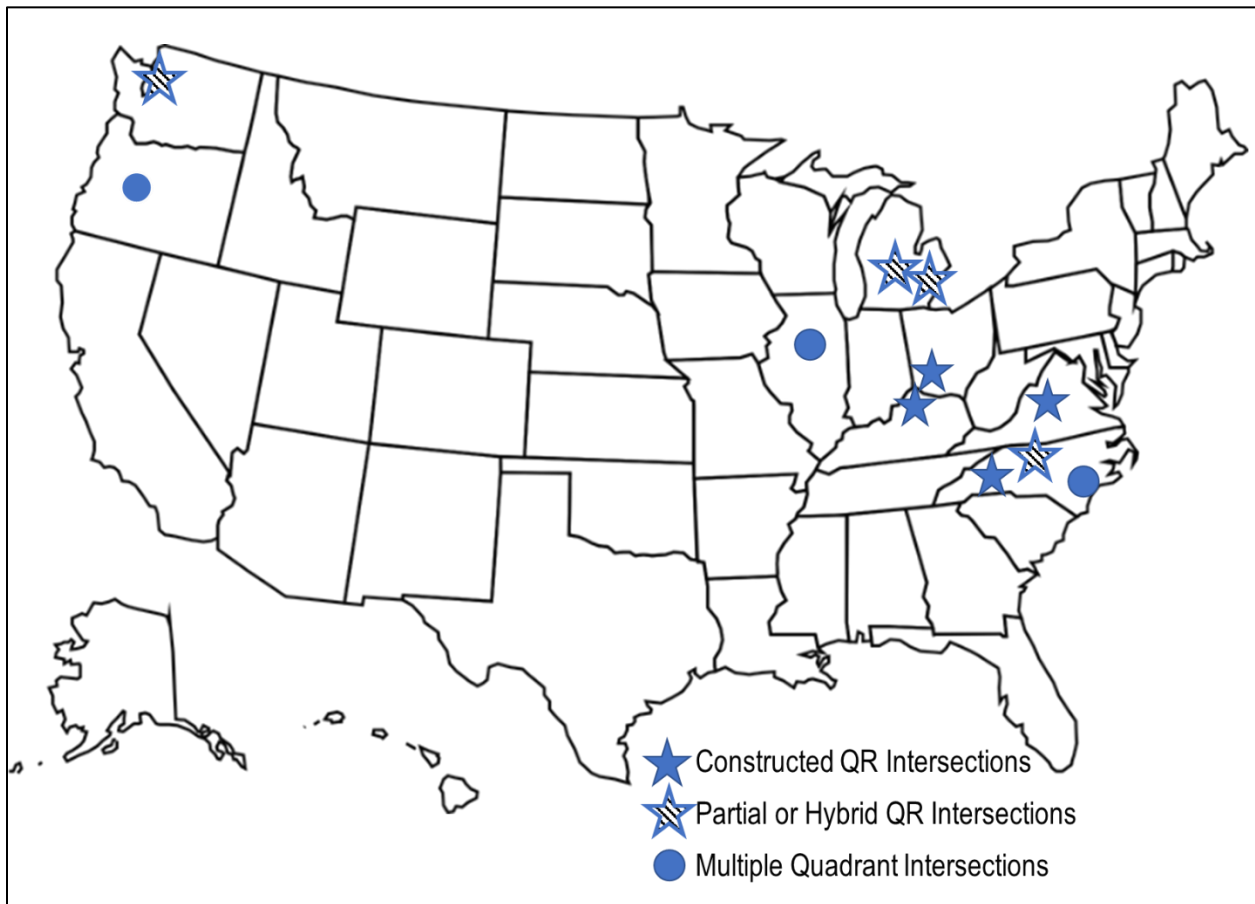

Source: FHWA

Figure 4. Graphic. Locations of QR intersections in the U.S.



© ODOT

Figure 5. Photo. SR-4 / SR-4 Bypass QR intersection, Fairfield, Ohio.



© 2019 Google Earth®

Figure 6. Photo. NC-73 / US-21 Partial QR intersection, Huntersville, North Carolina.⁽²⁾



© Virginia Department of Transportation.

Figure 7. Photo. US-340/522 / SR-55 QR intersection, Front Royal, Virginia. Provided by Virginia Department of Transportation.



© KYTC

Figure 8. Photo. US-42 / KY-872 QR intersection, Florence, Kentucky.

Table 1 compares the different design, contextual, and built environments for the four most recent QR intersections built or under construction. Elements of each of these intersections are detailed throughout the guide and a profile of each intersection is included in Appendix A.

Table 1. Comparison of QR intersection.

Criteria	SR-4 at SR-4 Byp Fairfield, OH	US-21 at NC-73 Huntersville, NC	US-340 at SR-55 Front Royal, VA	US-42 at KY-872 Florence, KY
Quadrant Roadway	Constructed new	Repurposed existing roadway	Constructed new	Constructed new
Main Crossing Intersection	Full QR	Partial QR	Full QR	Full QR
Secondary T-Intersection	Both T-intersections	Both intersections have 4th leg (1 full access, 1 partial)	Both T-intersections w/ access control	Both T-intersections
Avg. Daily Traffic (ADT) Volumes	Year: 2011 SR-4: 40,500 SR-4 Byp: 19,200	Year: 2016 NC-73: 44,000 US-21: 22,000	Year: 2017 US-340: 18,000 SR-55: 4,000	Year: 2016 US-42: 37,500 KY-872: 15,600
Lanes on quadrant roadway	6	3	5	3
Area Inscribed by QR	Vacant	Retail / commercial developments	Vacant	Retail / commercial developments
Pedestrian / Bicycle Accommodations	None	Sidewalks on all roadways	Sidewalks on all approaches; Bike lane on US-340	Sidewalks on all roadways
Access on QR	No access to adjacent land uses	Median break & RIRO access to adjacent land uses	No access to adjacent land uses	RIRO access to adjacent land uses & 1 full-access pt.
Medians on QR	None	Raised median; one directional opening	Raised median	None

GEOMETRIC DESIGN CONSIDERATIONS

Unlike many other alternative intersections, the QR has few unique design prescriptions other than the signature roadway in one intersection quadrant that facilitates the redirection of all left turns. A QR intersection design is influenced by the availability of land in one or more intersection quadrants and the spacing of existing roadways, intersections, and driveways along both intersecting roadways. The quadrant roadway can be built as a new roadway or developed by repurposing an existing roadway to function as the quadrant roadway, often requiring roadway and intersection geometric and signalization improvements.

Planning and design decisions are highly influenced by right-of-way (ROW) limits and availability on both crossing roadways and in the intersection quadrant(s), existing and future land use, access needs in the area inscribed by the quadrant roadway, intersection spacing, bicycle and pedestrian volumes, and traffic demands. The quadrant roadway can have a varying number of through and turning lanes depending on current and projected intersection left-turn volumes, land uses bisected by and adjacent to the quadrant roadway, and existing or planned future access to the quadrant roadway.

Quadrant Roadway Flexibility

The QR intersection is one of few alternative intersection forms that can be built effectively in any urban, suburban, and rural environment. In rural areas, undeveloped land parcels in one or more intersection quadrants in which to plan and construct a quadrant roadway are often more readily available. At intersections of foreseen future significance, the QR intersection footprint can be preserved when new land uses first emerge, and the quadrant roadway can evolve over time as traffic builds, as illustrated in figure 9 through figure 11.

Figure 9 illustrates a roadway constructed in one quadrant of an intersection on a strategically important State or municipal roadway network at a time when one or more quadrants are undeveloped. As traffic volume levels permit, the secondary T-intersections can operate under minor-street stop conditions. Direct left turns are permitted at the main intersection.

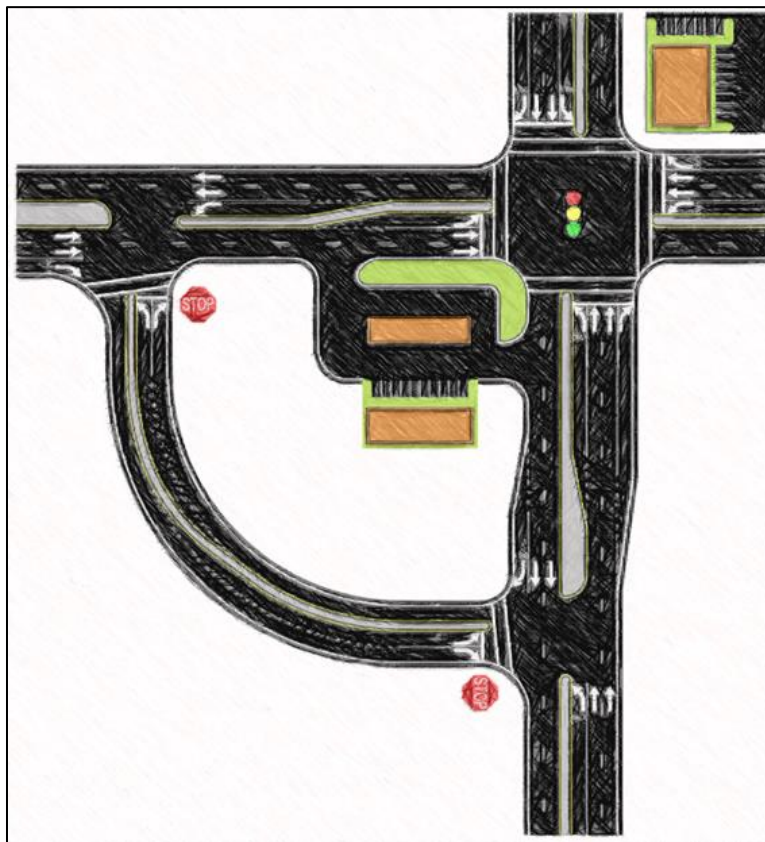

© NCDOT

Figure 9. Graphic. QR intersection evolution: initial quadrant roadway.

As intersection congestion grows due to increased development and traffic volumes and/or safety issues arise at one (or both) secondary T-intersections, these intersection(s) can be signalized. The secondary T-intersection signals can be coordinated with the main intersection still running multi-phase signal operations. Figure 10 illustrates the QR intersection with coordinated, signalized secondary T-intersections, still with direct left turns at the main intersection.

When intersection traffic volumes increase to cause an unacceptable level of operations, the full QR intersection can be implemented, as illustrated in figure 11. Construction activities to make the conversion include eliminating the left-turn bays on both intersecting roadways, revising signal and pedestrian heads, and perhaps adding additional turn lanes on the quadrant roadway.

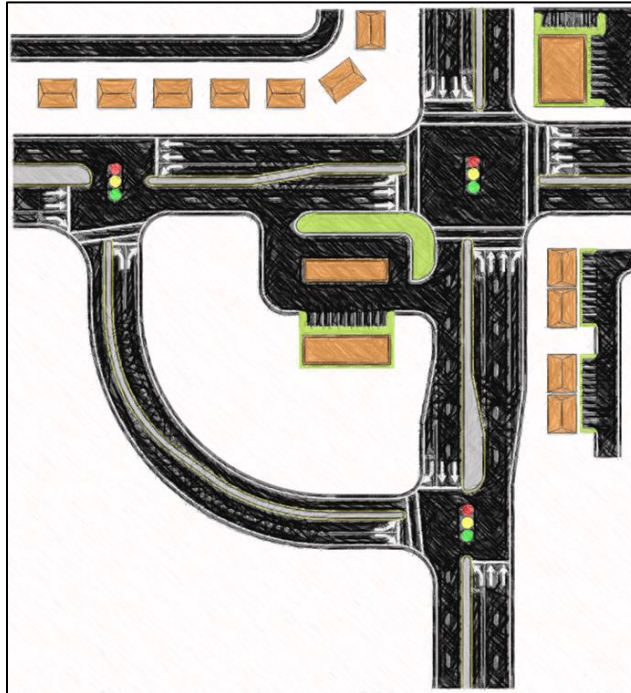

© NCDOT

Figure 10. Graphic. QR intersection evolution: coordinated signal operations.



© NCDOT

Figure 11. Graphic. QR intersection evolution: final configuration.

Under this planned conversion scenario, the motoring public would have to be informed and new habits formed during each intersection operational change. Also, there is a risk that the initial decision for an ultimate QR intersection made by one governing agency may not be advanced by future governing agencies. Close coordination with local governments and transportation

planning organizations is key to a successful phased approach, and all stakeholders need to be kept aware of the planned evolution.

Where greenfield development of a quadrant roadway is not available, and no roadway is suitable for conversion to a quadrant roadway, community planners may consider redevelopment of an intersection quadrant when rezoning opportunities present themselves. Site redevelopment plans that include a quadrant roadway may improve access to commercial redevelopment by the improved accessibility and increased pass-by traffic the quadrant roadway affords to that quadrant.

Quadrant Roadways in Urban Environments

There are many opportunities for QR intersections in urban areas across the U.S. that can improve congested intersections in urban areas by reducing signal phases, providing greater multimodal opportunities and providing "back roadway" access to serve development. Figure 12 illustrates a QR concept for an urban area.



© Metro Analytics

Figure 12. Graphic. Rendering of QR in urban area.

Many downtown or other urbanized areas are looking to implement Complete Streets, including broader pedestrian, bicycle, and transit amenities. The QR intersection may be a means to add space for these amenities by the removal of center turn lanes. The quadrant roadway may be developed using new or existing streets within the block-spacing of city streets. Eliminating left-turn lanes at the main intersection can open anywhere from 8 to 16 ft of ROW along the outside lanes that can be repurposed for wider sidewalks, a bikeway, a multi-use trail, or other complete street amenities. A well-planned QR intersection makes it possible for vehicles to access buildings via the quadrant roadway, so driveways can be removed (or not built) on both intersecting roadways. Used in urban settings, the QR main intersection operating under a two-phase signal becomes much easier to coordinate with other signals in an urban street grid

network. Through movements on both roadways can support additional traffic with less delay, reduced queuing, and lowered speed limits without degrading average speeds. QR intersections also make it easier and safer for pedestrians to cross at the main intersection, as described in greater detail in chapter 3.

Figure 13 and figure 14 illustrate a before/after cross-sectional illustration of how a QR can facilitate a Complete Streets development. According to best practices from ITE, the cross-section elements in figure 13 are inappropriate for aspiring walkable mixed-use environments that a community may desire at major intersections (i.e., 12-ft lanes are too wide, and a 45-mph speed limit is too fast for the desired environment).⁽³⁾ The redesigned QR intersection cross section in figure 14 includes narrower lanes and traffic calming features effective in reducing maximum speeds, which greatly improves safety. In addition, conversion to fewer signal phases afforded by the QR intersection can result in a more consistent peak-period experience despite the lower speed limit, for a “drive slower, travel faster” effect.

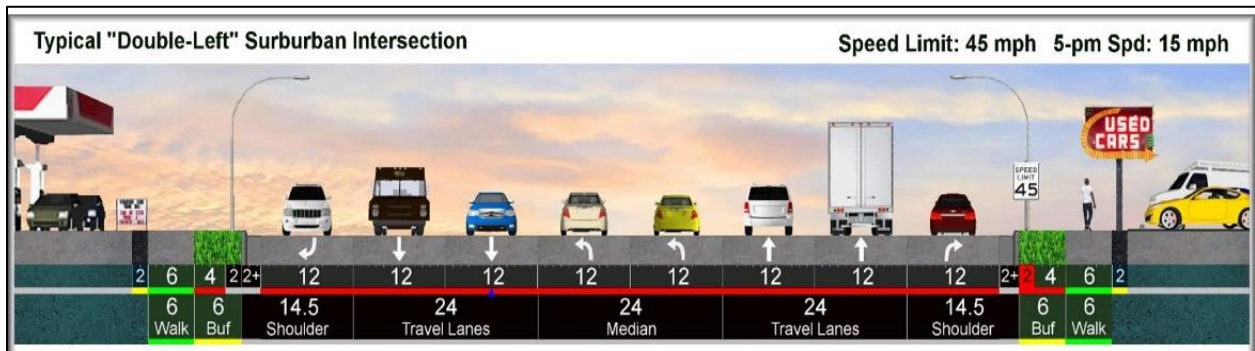

© Metro Analytics

Figure 13. Graphic. Conventional intersection with double left-turn lanes.

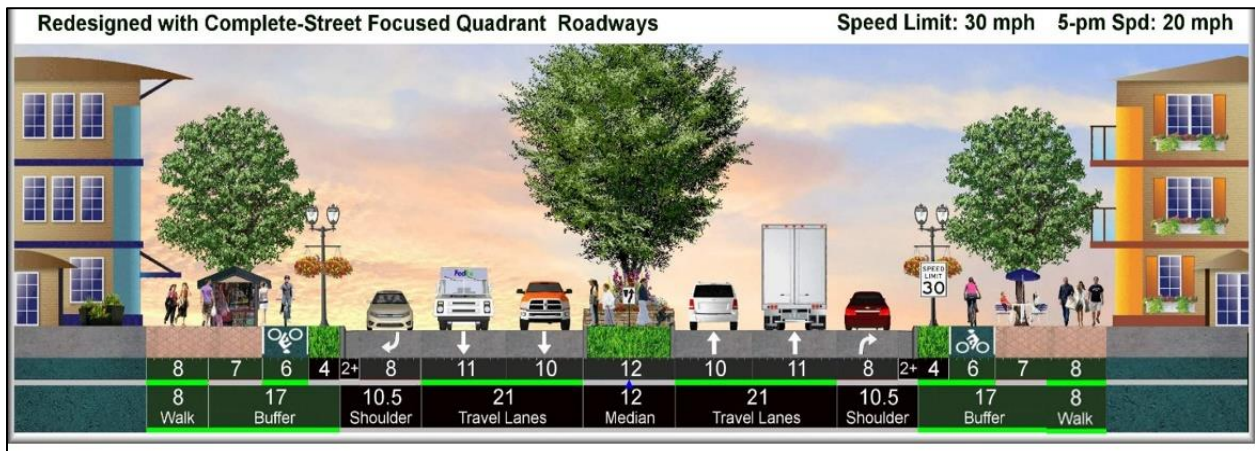

© Metro Analytics

Figure 14. Graphic. QR intersection facilitation of Complete Street development.

QR Intersection as an Interim Step to Grade Separation

QR intersections can also serve as an intermediate stage between a conventional intersection and interchange. In this case, it is very important to emphasize planning, designing, and reserving ROW for the entire future interchange condition, not just the at-grade QR intersection. Otherwise, development will occur around the QR and intersection in the interim, negating the ability to construct the future interchange. Early in the development of a QR intersection, the governing highway agency may operate the intersection with conventional signalization, while acquiring and/or reserving ROW in one quadrant for future construction of a QR intersection. When demands are high enough to justify, the agency could build the quadrant roadway and operate the intersection as a QR intersection. In this intermediate stage, the QR intersection provides the benefit of efficient operations without the expense of constructing an interchange. If and when traffic demand exceeds the capacity of the at-grade QR intersection, the governing agency can build a grade-separated quadrant interchange, using the quadrant roadway as a staging roadway during the construction of the grade-separation of one roadway over the other or perhaps as part of the ramp system.

Variations of the QR Intersection

There are several design modifications that can be made to QR intersection to respond to specific operational, access, or area context needs, including:

- One or both of the secondary T-intersections are roundabouts.
- Providing access to parcels bisected by, or adjacent to, the quadrant roadway.
- Redirecting left turns onto the QR from only *one* of the intersecting roadways (partial QR).

Secondary T-Intersection Roundabouts

Figure 15 is a conceptual rendering of a QR intersection with a roundabout at one of the secondary T-intersections. Assuming a single or dual-lane roundabout can provide sufficient intersection capacity and does not induce queues that spill back to the main intersection, a roundabout intersection has two significant operational advantages: 1) the roundabout intersection simplifies the coordination of the two remaining signals, and 2) it allows a fourth leg to be added to the roundabout intersection without detrimental effects on traffic operations on either street or to overall QR intersection operations.

Access Provisions to Inscribed Quadrant

Figure 16 illustrates a QR intersection where land uses are inscribed within the quadrant roadway. These land uses have access directly onto the quadrant roadway at a full-access intersection, as well as right-in/right-out (RIRO) access to both intersecting roadways.

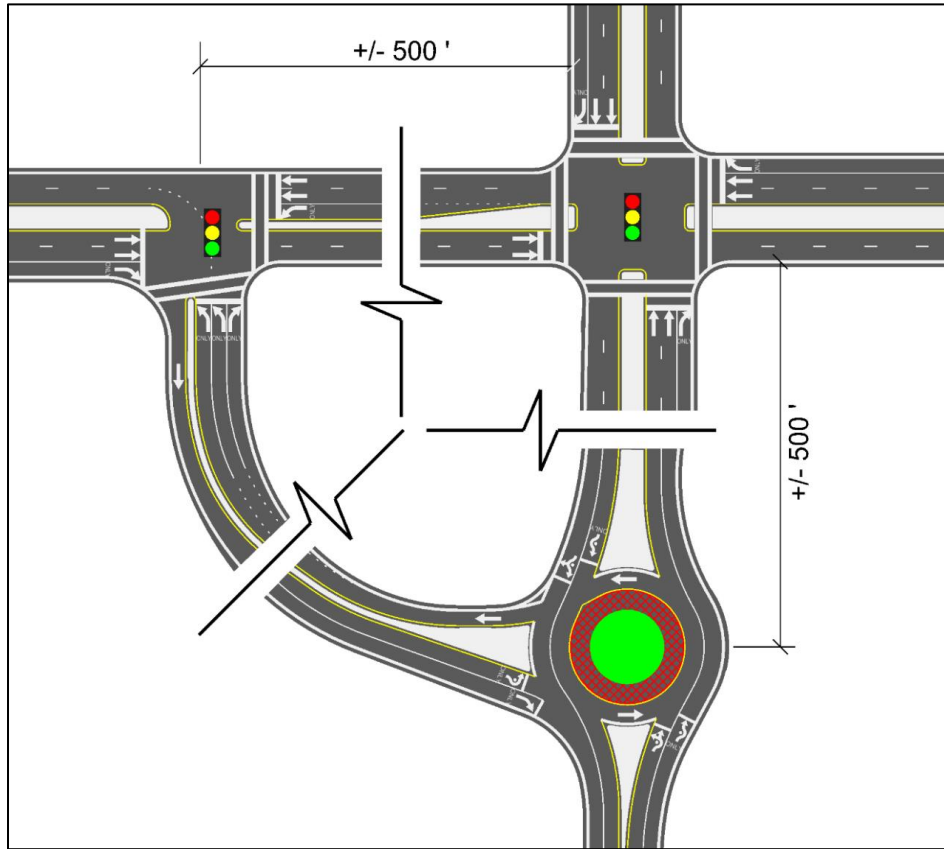

© NCDOT

Figure 15. Graphic. QR intersection with secondary T-intersection roundabout.



© KYTC

Figure 16. Photo. QR intersection with access to inscribed land uses.

Partial Quadrant Roadways

As previously illustrated in figure 2 and figure 3, left turns from each intersecting roadway are served in differing directions on the quadrant roadway. At the partial QR intersection in Huntersville, NC, left turns from NC-73 are made indirectly using the quadrant roadway in a counterclockwise direction, while direct left turns are allowed from US-21 at the main intersection. This creates an imbalanced demand for lanes on the quadrant roadway. Figure 17 illustrates the NC-73 / US-21 partial QR intersection, which includes a three-lane quadrant roadway, with two lanes in the counterclockwise direction to serve left turns from both directions on NC-73, and one lane in the clockwise direction to serve right turns and land uses with access to the quadrant roadway.



© Town of Huntersville NC

Figure 17. Photo. Imbalanced lanes on partial QR intersection.

Other QR Intersection Forms

While the scope of this guide focuses on the single-quadrant at-grade intersection form, there are other forms of intersections using quadrant roadways to relocate left turns that have been constructed in the U.S. These QR forms include: intersections with quadrant roadways in dual or all four quadrants, grade-separated quadrant intersections, and hybrids of a quadrant roadways with other alternative intersection forms. The following section describes and illustrates these quadrant intersection variations. These other quadrant intersection forms may be appropriate to consider when evaluating intersection improvement alternatives, but detailed investigations of these intersection forms are outside the scope of this guide.

Dual-Quadrant Roadways

Figure 18 illustrates quadrant roadways in two opposite quadrants (called a “Dual Quadrant” intersection). This alternative intersection simplifies both secondary T-intersections to allow two-phase signal operations and movement paths that are more uniform to meet driver expectations; however, finding two opposite and suitable intersection quadrants can be challenging in built-up urban and suburban areas and bicycles and pedestrians have additional intersections to cross.



© 2019 Google Earth®

Figure 18. Photo. Dual Quadrant intersection (Bend, Oregon).⁽⁴⁾

Four-Quadrant Intersections

Figure 19 illustrates quadrant roadways in all four intersection quadrants. Examples of four-quadrant intersections can be found in many communities in the U.S., but the added quadrant roadways are rarely used in conjunction with removal of left turns at the main intersection, including at this location. Therefore, the four-quadrant intersection (without redirecting left turns at the main intersection) helps local motorists familiar with left-turn “shortcuts” to avoid the main intersection, but overall main intersection operational gains are limited.

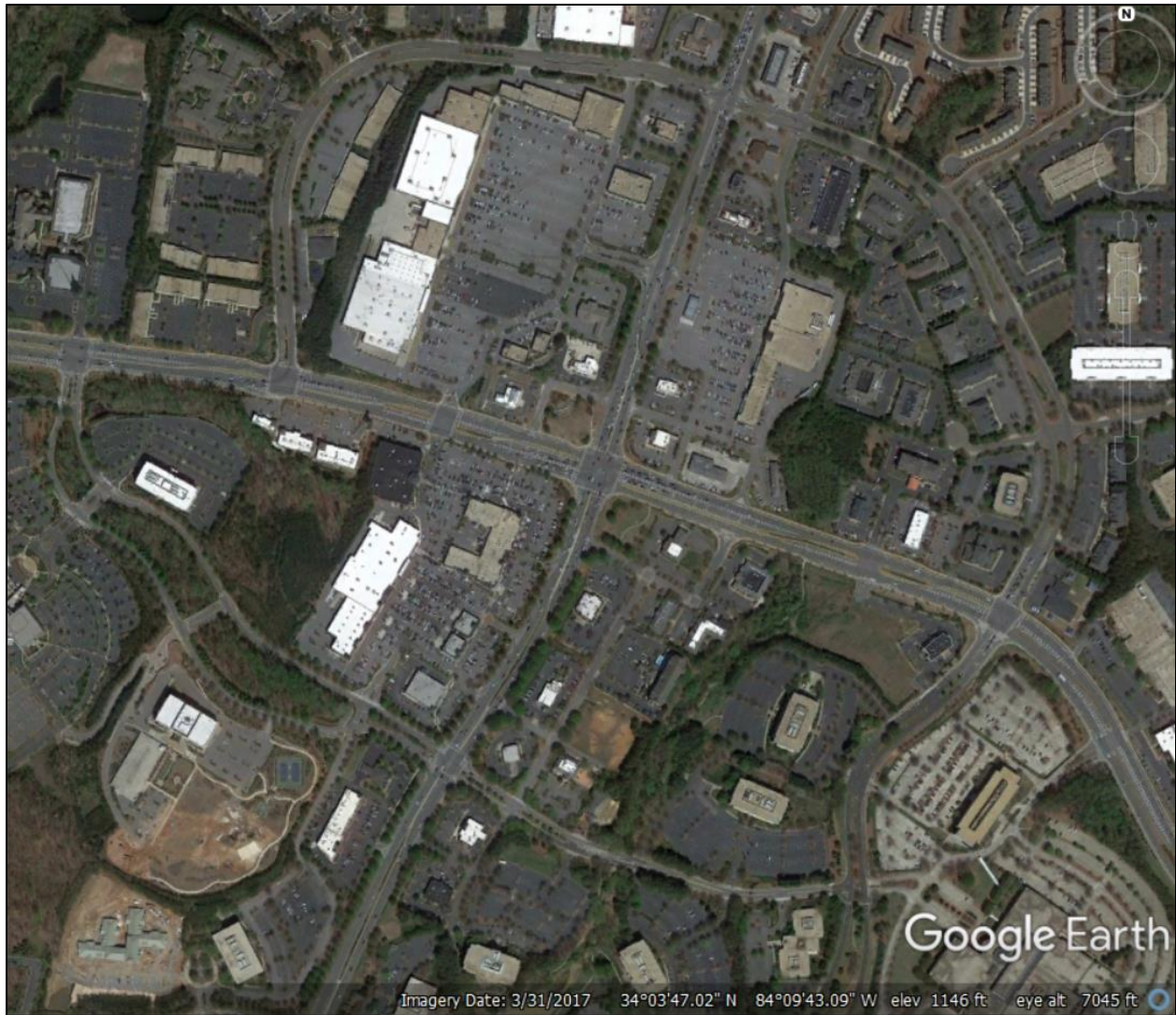

© 2019 Google Earth®

Figure 19. Photo. Four-Quadrant intersection (Alpharetta, Georgia).⁽⁵⁾

Grade-Separated QR Intersection

There is also a grade-separated form of the QR intersection. Under this design, the secondary T-intersections operate the same way as described for the QR intersection but the two intersecting roadways are grade separated. Figure 20 illustrates a grade-separated quadrant intersection in an urban area. This grade-separated intersection form is fairly common in the U.S. and can be found in rural, suburban, and urban settings. This design further eliminates intersection conflict points and can provide significant capacity gains compared to the at-grade QR intersection, particularly when one or both roadways have high volumes. However, grade separating roadways can have negative impacts to roadway access (particularly on the elevated roadway) and can divide communities if not planned and designed for cohesiveness.



© 2019 Google Earth®

Figure 20. Photo. Grade-separated QR intersection (Owens Mill, Maryland).⁽⁶⁾

Hybrid QR Intersection Forms

Figure 21 illustrates the combination of a QR intersection with a median U-turn corridor in southeast Michigan. In this design, two left-turn movements are made using the QR roadway while the other two left turns are made using the median U-turn crossovers on the median divided major roadway.



© 2019 Google Earth®

Figure 21. Photo. Hybrid QR / Median U-Turn (Bloomfield Hills, Michigan).⁽⁷⁾

RESOURCE DOCUMENTS

This guide is supplemental to major resource documents including, but not limited to:

- A Policy on Geometric Design of Highways and Streets (American Association of State Highway and Transportation Officials [AASHTO] Green Book).⁽⁸⁾
- Highway Capacity Manual (HCM).⁽⁹⁾
- Manual of Uniform Traffic Control Devices (MUTCD).⁽¹⁰⁾
- FHWA Signalized Intersections: Informational Guide.⁽¹¹⁾
- Highway Safety Manual (HSM).⁽¹²⁾
- Other referenced research documents that are more specialized to specific areas of the guide include various National Cooperative Highway Research Program (NCHRP) reports, Transportation Research Board (TRB) papers, Institute of Transportation Engineers (ITE) and FHWA publications.

The following are supplemental resource documents specific to QR intersections:

- ITE Journal (Vol 70 No 6, June 2000): Using Quadrant Roadways to Improve Arterial Intersection Operations.⁽¹⁾
- FHWA Alternative Intersections and Interchanges: Informational Report (AIIR).⁽¹³⁾
- FHWA Tech Brief on Quadrant Roadway Intersections (FHWA-HRT-09-058).⁽¹⁴⁾
- TRB 5th Urban Street Symposium: An Update on the Quadrant Roadway Intersection.⁽¹⁵⁾

CHAPTER 2 — POLICY AND PLANNING

This chapter contains guidance on how to consider alternative intersections in general and QR intersections in particular. It also summarizes policy and planning considerations related to QR intersections. The remaining chapters of this guide will provide specific details of the multimodal, safety, operations, geometric design, and traffic control features of QR intersections.

Alternative intersections are often initially considered for operational or safety needs, and other key factors may include spatial requirements and multimodal needs. This chapter provides approximate footprints for different types of QR intersections to allow for planning-level screening and feasibility analysis.

PLANNING CONSIDERATIONS FOR ALTERNATIVE INTERSECTIONS

Alternative intersection evaluations may vary depending on the stage of the project development process. Each project stage can affect how the policy and technical considerations are assessed. While operation, design, safety, human factors, and signing controls should be considered at every stage of the development process, a planning-level design evaluation may not require the same level of analysis or detailed evaluation of each consideration as projects in later development stages. Evaluations should be as comprehensive as needed to answer key project questions for each unique project context.

Specific planning level considerations that may make QR intersections an attractive alternative include improved pedestrian and bicycle quality of service, improved intersection operational efficiency, and a reduced footprint along the intersecting roadways.

Serving Pedestrians and Bicycles

When considering a QR intersection, integrating pedestrian and bicycle needs at an early stage of the project planning process yields a higher quality solution. The unique characteristics of a QR intersection typically reduce pedestrian crossing distances, vehicle/pedestrian conflict points, intersection cycle lengths (more cycles per hour), and the number of signal phases—all of which result in benefits to pedestrians and bicyclists.

Pedestrians crossing through a QR intersection encounter fewer vehicular conflict points than at a conventional intersection; however, the QR intersection adds additional signalized intersections that some pedestrians must cross. At the main intersection, crosswalks can be placed across all intersection legs and generally follow direct corner-to-corner crosswalk paths similar to conventional intersections. Pedestrians cross one street during the opposite street through and right-turn signal phase and vice-versa.

Removing the left turns from the main intersection creates two-phase signal operations. This allows for a shorter signal cycle length while maintaining a similar green time for pedestrians and vehicles compared to a conventional intersection. This benefits pedestrians by creating more pedestrian phases per hour and less “don’t walk” time between “walk” phases (i.e., less wait time between walk signals).

Complete Streets is a transportation policy and design approach requiring a street to be planned, designed, operated, and maintained to enable safe, convenient, and comfortable travel and access for users of all ages and abilities regardless of their mode of transportation. Even where built along principal or other high-volume streets designed to carry vehicles at higher speeds, QR intersections can be designed or retrofit to accommodate bicycle lanes.

Most through and right-turning bicyclists navigate QR intersections in the same way as conventional intersections, with one right-turn movement having the option to use the quadrant roadway. Left-turning bicyclists have several options for navigating a QR intersection. Some movements can use the quadrant roadway and move with vehicular traffic. Others can pass through the intersection on a multi-use path as a pedestrian would. A third option is for bicyclists to make direct left turns and wait on the shoulder in bicycle lanes or bicycle boxes.

While there are many opportunities for multimodal accommodations at a QR intersection, these design elements are not without challenges. Chapter 3 of this guide discusses challenges and considerations and provides recommendations for how to achieve safe and efficient provisions for multimodal users of QR intersections.

Improved Operations

Alternative intersections have been well documented to improve intersection operations in many applications across the U.S. There are many different forms of alternative intersections and interchanges that vary in means but are similar in purpose to relocate left turns away from the main intersection. Table 2 lists the known alternative intersection, grade-separation, and interchange forms used in the U.S. Many have both signalized and unsignalized forms.

Table 2. Alternative intersection and interchange types used in the U.S.

Unsignalized Intersections	Signalized Intersections	Grade-Separated Intersections	Interchanges
<ul style="list-style-type: none"> • High-T intersection • Mini, single, and multi-lane roundabouts • Offset-T intersection • RCUT / J-Turn intersection • RIRO w/downstream U-Turn 	<ul style="list-style-type: none"> • Bowtie • Continuous Flow • Continuous Green-T • Jughandle • Median U-Turn • Quadrant Roadway • RCUT (Superstreet) 	<ul style="list-style-type: none"> • Echelon • Single Quadrant 	<ul style="list-style-type: none"> • Displaced Left Turn • Diverging Diamond • Median Urban Diamond • Single Point Urban Diamond • Single, Dual, and Peanut roundabout interchanges

The commonality of these alternative intersections is reduced conflict points, reduced signal phases, fewer clearance phases, and increased green time for through and right-turn movements, particularly for the roadway with dominant through movements. Fewer signal phases can allow shorter intersection cycle lengths resulting in more cycles per hour, further reducing vehicle delays and queuing.

As part of ongoing efforts to improve the safety performance of all roads, FHWA encourages State Departments of Transportation (DOTs) to “consider alternative geometric intersection and interchange designs, which are specifically designed to reduce or alter conflict points, and allow for safer travel for motorists, pedestrians, and bicyclists. Past and ongoing FHWA studies of various alternative intersection and interchange designs implemented within the last few years document the magnitude of both safety and operational improvements”.⁽¹⁶⁾

Research in these and other documents finds that alternative intersections provide the greatest operational benefits compared to conventional intersection design at volume levels where conventional intersections begin to fail but do not justify grade separation. Many alternative intersections have delayed the construction or otherwise replaced projects to grade separate an

intersection, providing sufficient at-grade intersection operations without the cost and access impacts of grade separation. Research also shows that alternative interchanges provide the greatest operational benefits at volume levels where conventional diamond or other conventional interchanges begin to fail but do not justify system interchange forms.

Figure 22 conceptually depicts the relationship of conventional intersections, alternative intersections, and grade separations in their ability to serve increasing traffic volumes. Chapter 5 documents the operational benefits of the QR alternative intersection compared to conventional intersection forms.

QR intersections are best suited at intersections with balanced approach volumes (i.e., one roadway volume is not dominant over the other) and best competes with Median U-Turn and Continuous Flow intersections in a niche where two higher-demand streets meet. QR intersections do not compete with RCUT and other alternatives where the volumes on the two intersecting roadways are highly disproportionate, nor is it suited for intersections with less than four approaches.

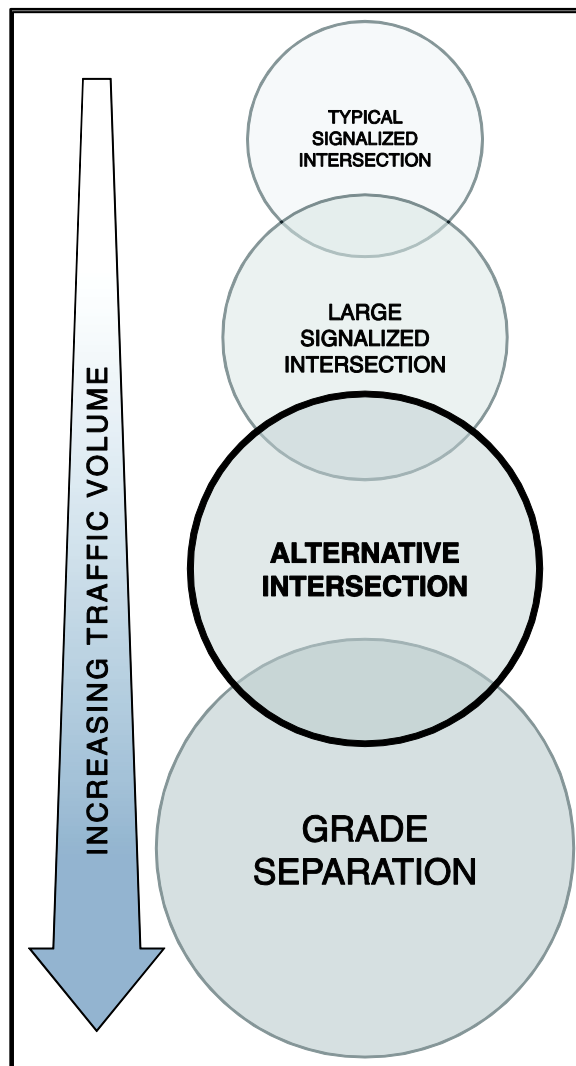

Source: FHWA

Figure 22. Graphic. Relationship between traffic volume served and intersection type.

Reduced Roadway Footprint

QR intersections generally have a smaller footprint along both intersecting roadways compared to a conventional intersection. Left-turn lanes are removed at the main intersection and the T-intersections typically require only a single left-turn lane, resulting in a narrower cross section compared to a conventional intersection with dual left-turn lanes.

As an example, figure 23 illustrates a QR intersection footprint overlaid on the existing footprint at the meeting of two major roadways in Gwinnett County, Georgia. In this concept, the quadrant roadway requires a pavement area equaling 1.05 acres in a ROW of approximately 1.5 acres (excluding the area inscribed by the quadrant roadway); however, the pavement area saved along the two roadways is approximately 1.6 acres in a ROW of 1.8 acres (approximately 5.5 acres if the entire area inscribed by the quadrant roadway is included). In this case, the existing roadway pavement is not a savings (the pavement exists); however, this area could be repurposed for bicycle, pedestrian, or other Complete Streets purposes.

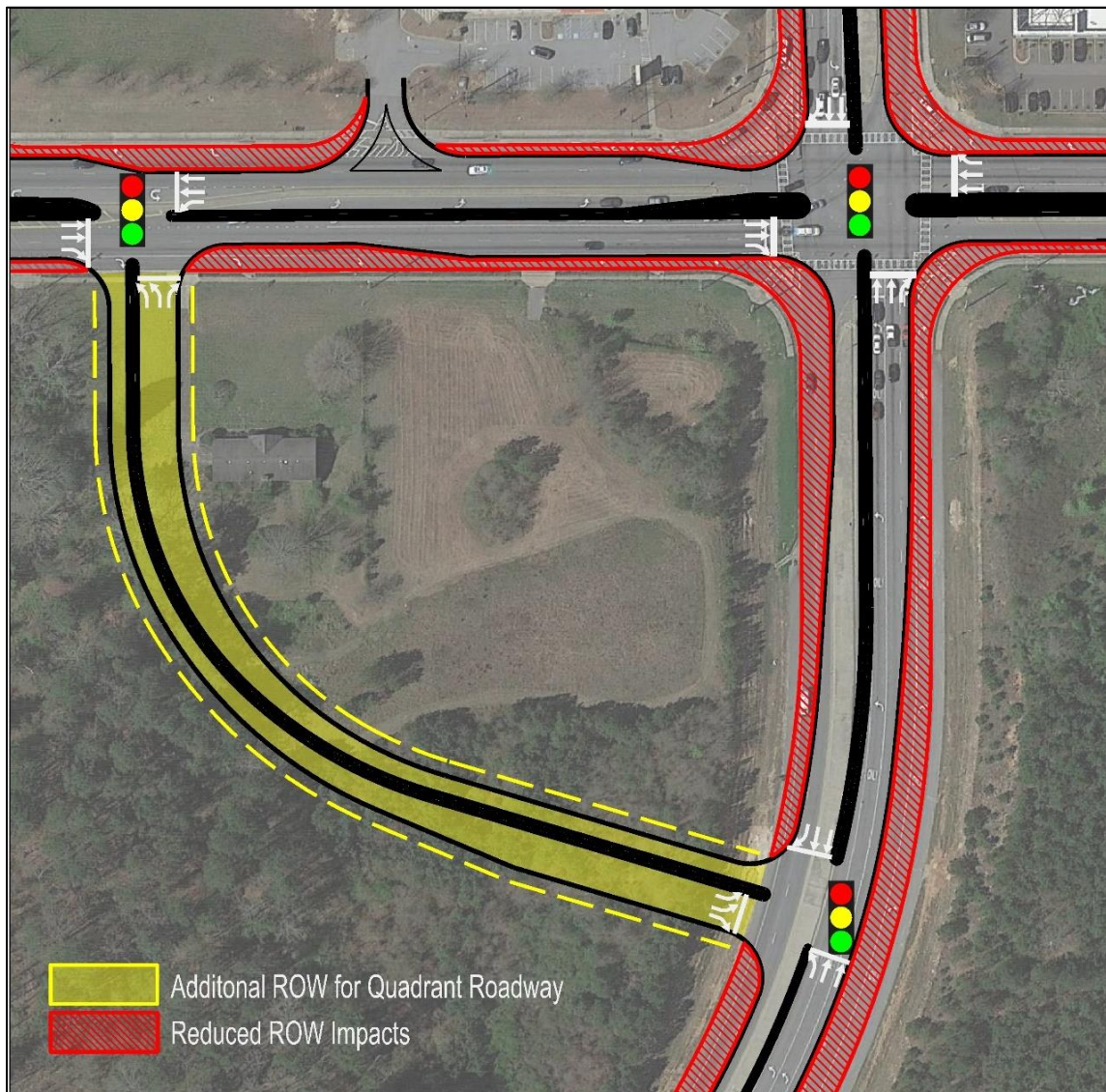

© NCDOT

Figure 23. Graphic. QR intersection footprint compared to a conventional intersection.

The savings of ROW and/or pavement along the intersecting roadways makes the QR intersection a good choice for improvement at intersections with constrained ROW or close roadside development that would be impacted by traditional widening improvements. This additional space may be re-purposed for multimodal or other roadside improvements. Should future roadway improvements be required, one or both roadways can be widened to the outside, leaving the quadrant roadway configuration and median turn lanes unchanged.

STAKEHOLDER OUTREACH

Stakeholder outreach is a critical part of any transportation project planning process, particularly when involving alternative intersections unfamiliar to the public and project stakeholders. Successfully implementing the first QR intersection in a community may require targeted and proactive outreach and education to affected stakeholders and the general public. This would create opportunities to familiarize others with the potential benefits of QR intersections while creating opportunities to hear project-specific concerns and considerations to properly plan, design, and construct a successful QR intersection.

Creating multiple forums to engage the public (including presentations at local council or board meetings, briefings at community organization functions, and project-specific open house meetings) results in opportunities to listen to community interests and share objective information about the intersection form. Media campaigns through local newspapers, television, informational videos, and public meetings can be effective methods of keeping the community informed.

Videos are another helpful tool for public outreach and user education used by many agencies to demonstrate QR intersections. Some of the videos are developed through simulation tools; other driver simulation videos help illustrate what drivers may expect when they travel through a QR intersection. Figure 24 and figure 25 are examples of video animation used to describe how to travel through a QR intersection. These video clips include narration that speak to the general public with a clear message of how a QR intersection functions for both a specific project and generic QR intersection, respectively. The video captured in figure 25 also highlights multimodal benefits of a QR intersection and can be found on the Virginia Department of Transportation (VDOT) innovative intersections website.

Videos can also be produced from many off-the-shelf microsimulation models used to analyze a specific project. These are very beneficial to the public to not only provide operational analysis results but to illustrate how the QR intersection functions and visually fits within the context of the intersection and community. Figure 26 illustrates a microsimulation model of a QR intersection used during the project planning stages to show proposed QR intersection traffic operations compared to conventional intersection improvements. Microsimulation data can also be exported into computer models for more realistic videos of intersection operations that bring in bicycle, pedestrian, and 3-D elements into the video, as illustrated in figure 27.⁽¹⁷⁾



© Town of Huntersville NC

Figure 24. Graphic. Screenshot from video describing movement paths for QR project.



© Virginia Department of Transportation.

Figure 25. Graphic. Screenshot from QR intersection informational video. Provided by Virginia Department of Transportation.



© NCDOT

Figure 26. Graphic. QR intersection microsimulation video.



© Kittleson and Associates

Figure 27. Graphic. Enhanced project video using microsimulation data.

POLICY CONSIDERATIONS

Designing, operating, and managing streets and intersections should align with the appropriate jurisdictional policies associated with that facility. The facility context, location, and type can often dictate the appropriateness of the ROW and access management needs associated with alternative intersections. The degree to which motor vehicle throughput should or should not be prioritized over other modes also plays a role in determining the appropriateness of alternative intersections at specific locations.

Some of the policy considerations of a QR intersection include:

- Access management policies and best practices.
- Driveway and signal spacing criteria.
- Operational measures of effectiveness (MOEs) and criteria.
- Pedestrian facilities and wayfinding for persons with disabilities, including requirements of the Americans with Disabilities Act (ADA) and Section 504 (the Rehabilitation Act).⁽¹⁸⁾
- Complete Streets policies or other provisions for safe and convenient pedestrian and bicycle facilities.
- Design vehicle requirements.
- Snow removal and storage.
- Incident management.
- Emergency response needs.

Access Management

The subject of multiple and closely-spaced intersections, which can present challenges for movement progression and safety, has been one of the biggest concerns noted by practitioners involved in planning, building, and operating QR intersections, as well as by researchers who study the effects of QR intersection operations and safety. This section discusses how QR intersections differ from conventional intersections, and the specific access management issues relative to the QR intersection. Of equal importance to the management of traffic and progression through the multiple intersections is the preservation of only three legs of approaches at the secondary T-intersections. The operational and management impacts of allowing a fourth leg at either secondary T-intersection is described in greater detail in chapters 4 and 5.

Transportation agencies considering QR intersections where existing access points conflict with the secondary T-intersection location(s) may need to make access modifications or potentially trade the operational and safety benefits of controlled T-intersections in order to move the project forward. In some cases, QR intersections with compromised access management or even a partial QR intersection will operate better than conventional intersection improvements. Planners and designers should approach all QR projects with the intent of managing access required to operate a “pure” QR intersection; however, there may be access issues that, if left unresolved, may cause a QR intersection alternative to be dismissed. In such cases, engineers and decision-makers must weigh the operational and safety trade-offs associated with access management desires versus improvement project needs on a project-by-project basis.

PLANNING CONSIDERATIONS

The following are planning considerations for alternative intersection design:

- **Community goals** – Outside formalized land use policies, cities, and communities often have general goals that provide insights about the nature and character of their community. These goals can range from concepts that preserve a historic character or identified heritage to creating walkable communities or Complete Streets. Other goals can be to encourage economic development by preserving existing business or residential areas while encouraging thoughtful development or redevelopment. Regardless of the specific goals or vision, these considerations may influence street and intersection design.
- **Surrounding land uses and zoning** – Consider land uses surrounding the intersection and possible design modifications that can be made to improve land use and access viability.
- **Project context** – Questions to identify stakeholders for a particular project may include:
 - What is the purpose and function of the existing or planned street facilities?
 - What existing and planned land uses are adjacent to or linked to the street facilities?
 - Who will likely use the street facilities given the existing and planned land uses?
 - What are the existing and anticipated future socio-demographic characteristics of the populations adjacent to or linked to the existing or planned street facilities?
 - What are the perceived or actual shortcomings of the existing street facilities?
 - Who has jurisdiction over the facility?
 - Where is capital funding for the project originating (or expected to originate)?
 - Who will operate and maintain the facility?
- **Multimodal considerations** – As with any street segment or intersection, each configuration must consider and serve the various users who currently or may be expected to use the facilities. This includes pedestrians, bicyclists, and transit riders and can also include users with special needs such as the visually impaired, elderly, or young users.
- **Access management** – Consideration of which existing or planned roadway access points may need modifications or stringent controls to ensure optimal intersection operations.
- **Design vehicles** – The intersection geometry will need to accommodate transit, emergency vehicles, freight, and potentially OSOW vehicles.
- **Intersection roadway volumes** – The QR intersection is best suited for intersections where the volumes on both crossing roadways are generally similar in magnitude. If one roadway has disproportionately higher volumes than the other, the secondary T-intersection on the dominant roadway may not be able to provide adequate capacity for the overall QR intersection to work properly.

PLANNING CHALLENGES

Careful planning and addressing unique challenges pertaining to this alternative intersection form are a prerequisite for successful implementation of a QR intersection project. The following are some common challenges associated with planning QR intersections:

- **Driver education** – Successful implementations of alternative intersections are often preceded by public outreach and educational campaigns, which are typically not conducted for conventional intersection improvements. At QR intersections, the prohibition of left

turns at the main intersection and the use of the quadrant roadway for left turns should be communicated to the public prior to opening the intersection.

- **Driver expectation** – QR intersections have a differing left-turn pattern from each approach, some requiring counterintuitive movements from the right side of the street not meeting driver expectations. These left-turn paths must be clearly communicated in the intersection planning and design phases, particularly in signing and marking plans.
- **Multimodal** – As with most street or intersection improvements, QR intersections must consider and serve the various users who currently or may be expected to use the facilities. This should include pedestrians and bicycles, understanding that the exact provisions may necessarily vary from site to site. QR intersections should generally be compatible with transit services as well.
- **Sufficient quadrant ROW** – The greatest challenge for the QR intersection is the provision of sufficient ROW to accommodate the quadrant roadway in a location that allows proper function of the intersection. Spacing of the secondary T-intersections too close or too far from the main intersection will result in operational inefficiency and lower the public perception of the QR intersection as an effective intersection solution.
- **Roadway network** – Drivers may seek alternatives to QR intersection left-turn movements if they perceive a travel-time gain using adjacent roadway or parking-lot “cut-throughs”. The potential becomes greater when there is a fourth leg at one or both secondary T-intersections. Care should be taken in the project planning and design phases to eliminate paths to circumvent QR lefts (or make as difficult and time-consuming as possible).

PROJECT PERFORMANCE CONSIDERATIONS

Measuring the effectiveness of overall project performance depends on the nature or catalyst for the project. Understanding the intended specific operational, safety, and geometric performance context for each intersection or corridor, including intended users, can help determine project-specific performance measures. The project performance may be directly linked to the specific design choices and performance of the alternatives considered. The project performance categories described below can influence and are influenced by specific QR intersection design elements and their characteristics.

Accessibility

Chapter 3 of this guide describes accessibility as it relates to special consideration given to pedestrians with disabilities including accommodating pedestrians with vision or mobility impairments. However, for the purposes of considering a project’s general context and the performance considerations, the term “accessibility” goes beyond the conversation of policy related to ADA and Public Rights-of-Way Accessibility Guidelines (PROWAG) and is meant to be considered in broader terms.⁽¹⁹⁾ With respect to considering applicable intersection forms for a given project context, accessibility is defined broadly as the ability to approach a desired destination or potential opportunity for activity using highways and streets (including the sidewalks and/or bicycle lanes provided within those ROWs). This could include the ability for a large design vehicle to navigate an intersection as much as it might pertain to the application of snow mobiles or equestrian uses in some environments or conditions.

Mobility

Mobility is defined as the ability to move various users efficiently from one place to another using highways and streets. Mobility can sometimes be associated with motorized vehicular movement and capacity. For the purposes of this guide, mobility is meant to be independent of any particular travel mode.

Quality of Service

Quality of service is defined as the perceived quality of travel by any roadway user. It is used in the HCM 6th Edition to assess multimodal level of service (MMLOS) for motorists, pedestrians, bicyclists, and transit riders.⁽⁹⁾ Quality of service may also include the perceived quality of travel by design vehicle users such as truck or bus drivers.

Reliability

Reliability is defined as the consistency of performance over a series of time periods (e.g., hour-to-hour, day-to-day, year-to-year).

Safety

Safety is defined as the expected frequency and severity of crashes occurring on highways and streets. Expected crash frequencies and severities are often disaggregated by type, including whether or not a crash involves a non-motorized user or a specific vehicle type (e.g., heavy vehicle, transit vehicle, motorcycle). In cases where certain crash types or severities are small in number, as is often the case with crashes involving pedestrians or bicycles, it may be necessary to review a longer period of time to gain a more accurate understanding.

PROJECT DEVELOPMENT PROCESS

For the purposes of this report, the project development process is defined as consisting of the stages described below. Federal, State, and local agencies may have different names or other nomenclature with the overall intent of advancing from planning to implementation. Figure 28 illustrates the overall project development process.

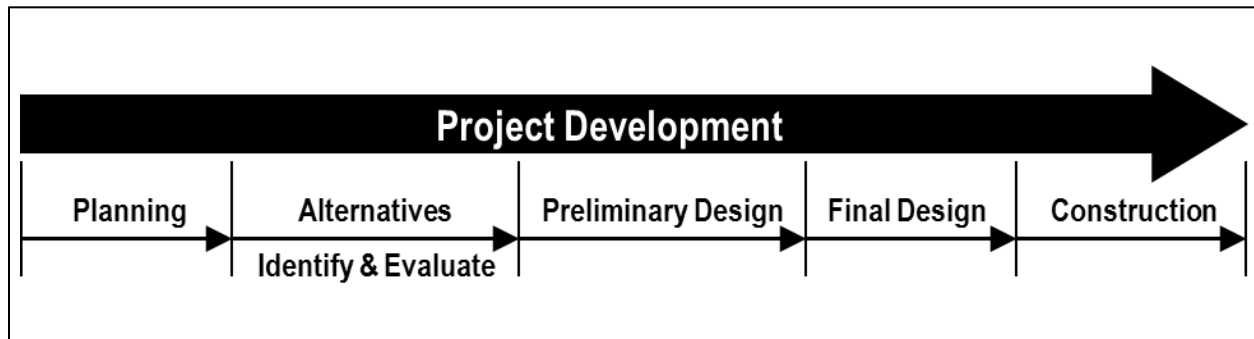

Source: FHWA

Figure 28. Graphic. Project development process.

Planning Studies

Planning studies often include exercises such as problem identification and other similar steps to ensure there is a connection between the project purpose and need and the geometric concepts being considered. Planning studies could include limited geometric concepts on the general type or magnitude of project solutions to support programming.

Alternatives Identification and Evaluation

The project needs identified in prior planning studies inform concept identification, development, and evaluation. At this stage, it is critical to understand the project context and intended outcomes so potential solutions may be tailored to meet project needs within the opportunities and constraints of a given effort. FHWA describes context sensitive solutions as “... a collaborative, interdisciplinary approach that involves all stakeholders in providing a transportation facility that fits its setting”.⁽²⁰⁾ In considering the concept of “context sensitive design/solutions”, this stage calls for meaningful and continuous stakeholder engagement to progress through the project development process.

Preliminary Design

Concepts advancing from the previous stage are further refined and screened during preliminary design. For more complex, detailed, or impactful projects, the preliminary design (typically 30 percent design level plans) and subsequent documentation are used to support more complex State or Federal environmental clearance activities. The corresponding increased geometric design detail allows for refined technical evaluations and analyses that inform environmental clearance activities. Preliminary design builds upon the geometric evaluations conducted as part of the previous stage (alternatives identification and evaluation). Some of the common components of preliminary design include:

- Typical sections.
- Horizontal and vertical alignment design.
- Grading plans.
- Traffic and intelligent transportation systems (ITS).
- Signing and pavement markings.
- Illumination.
- Utilities.

Final Design

The design elements are advanced and refined in final design. Typical review periods include 60 percent, 90 percent, and 100 percent plans before completing the final set of construction plans and documents. During this stage, there is relatively little variation in design decisions as the plan advances to 100 percent. Functionally, in this stage of the project development process, the targeted performance measures have a lesser degree of influence on the form of the project.

Construction

Construction activities could include geometric design decisions related to temporary streets, connections, or conditions that facilitate construction. Project performance measures may relate to project context elements.

SUMMARY OF QR INTERSECTION ADVANTAGES AND DISADVANTAGES

As described in chapter 1 and the previous sections of this chapter, QR intersections have unique features and characteristics related to multimodal considerations, safety performance, operations, geometric design, spatial requirements, constructability, and maintenance. Table 3 provides an overview of the advantages and disadvantages of QR intersections for users, policy makers, designers, and planners to understand when considering this type of alternative intersection form.

Table 3. Summary of QR intersection advantages and disadvantages.

MOEs	Advantages	Disadvantages
Non-Motorized Users	<ul style="list-style-type: none"> • Reduces most crossing movements conflicts between vehicles & pedestrians. • Pedestrians & bicycles cross fewer travel lanes (shorter distance, less exposure). • Two-phase signal operations increase service time to pedestrians & bicyclists. 	<ul style="list-style-type: none"> • Some pedestrians and bicycles must cross additional signalized intersections, increasing total exposure and delays.
Safety	<ul style="list-style-type: none"> • Fewer overall intersection conflict points. • No left-turn conflicts (severe crash potential) at the main intersection. • Lower delay and fewer stops on major street could reduce rear-end crash rates. 	<ul style="list-style-type: none"> • Potential for driver confusion/error due to unfamiliarity with intersection. • Additional signalized intersections could increase overall crash rates. • Higher right-turn volumes increase those vehicle-pedestrian conflicts.
Operations	<ul style="list-style-type: none"> • Shorter cycle lengths and increased green time for through movements. • Significant delay reduction and travel time savings over conventional intersections. • Significantly reduced queues and spillback potential. 	<ul style="list-style-type: none"> • Potential increase in delay, travel distance, and stops for some left turns. • Potential disregard of left-turn prohibitions. • Potential increased weaving as drivers accustomed to making lefts from left side of the road now make right turns.
Access Management	<ul style="list-style-type: none"> • Potential for improved/controlled access to developments in some intersection quadrants. 	<ul style="list-style-type: none"> • Potential for circuitous access to land uses in some intersection quadrants. • May need to relocate adjacent streets and/or driveways to accommodate T-intersections.
ROW / Space	<ul style="list-style-type: none"> • Narrow ROW footprint due to lack of left-turn lanes at main intersection. • Reduced roadway width and/or increased space for non-motorized users. 	<ul style="list-style-type: none"> • If no existing roadway is repurposed, requires ROW for new roadway in one intersection quadrant. • Requires ROW acquisition/construction of new roadway in one intersection quadrant.
Traffic Calming	<ul style="list-style-type: none"> • Narrower roadway footprint gives visual cues to slow vehicle speeds. • Greater intersection throughput provides potential for fewer through lanes. 	<ul style="list-style-type: none"> • None.
Construction/Management	<ul style="list-style-type: none"> • Construction of QR has minimal impact to either intersecting roadway. • QR can be used as detour route during construction and for maintenance. 	<ul style="list-style-type: none"> • Additional signage and pavement markings compared to conventional. • Construction and maintenance of two additional signals.
Aesthetics	<ul style="list-style-type: none"> • Quadrant provides opportunity for storm-water detention, park, or other civic value. 	<ul style="list-style-type: none"> • Quadrant area requires maintenance; could look blighted if unattended.

CHAPTER 3 — MULTIMODAL CONSIDERATIONS

This chapter provides an overview of multimodal considerations at QR intersections and how provisions for pedestrians, bicycles, transit, and heavy vehicles should influence the overall planning and design of these intersections. Several of the guidelines presented here are based on elements of the AASHTO Green Book but are applied within the unique context of a QR intersection.⁽⁸⁾ The overall objective is to develop a design, regardless of the type of intersection, compatible with a Complete Streets approach. Complete Streets are facilities that serve many types of users including freight, transit, and non-motorized users.

DESIGN PRINCIPLES AND APPROACH

QR intersection planning and design should consider a variety of transportation modes and needs. When considering a QR intersection, the following elements should be evaluated:

- The unique geometrics of the quadrant roadway and accessibility needs to surrounding intersection land uses must consider benefits and impacts to all transportation modes.
- The interaction of the three signalized intersections and the unique operations that reduce the number of signal phases at QR intersections can introduce both opportunities and challenges for pedestrians, bicyclists, transit vehicles, and users with disabilities.
- The prohibition of left-turn movements at the main intersection may create enforcement issues for automobiles and for bicycles if bicycle boxes, bicycle lanes, or other accommodations for direct left turns are not included in the design.
- Large vehicles require adequate design at the secondary T-intersections to accommodate dual turn lanes and swept paths. Geometrics may include wider turning lanes, paved shoulders, bump outs, and mountable/traversable features. Intersection geometry and all its associated movements need to accommodate the design vehicle for both crossing roadways.

Specific multimodal considerations are illustrated in figure 29 and described below.

- The reduced number of signal phases at the main intersection can make it easier to serve non-motorized movements compared to a multi-phase signal. At multi-phase signals, the need to provide adequate pedestrian clearance may result in the pedestrian movement controlling the phase lengths, leading to longer cycle lengths and greater pedestrian delay. In contrast, vehicle movements typically control phase length at two-phase QR intersection signals, which can better provide sufficient time per phase to serve pedestrians.
- At the secondary T-intersections, pedestrians and bicyclists can cross both roadways under signal control but are exposed to right-turning vehicles. This is not dissimilar to pedestrian crossings at a conventional intersection; however, the number of right-turning vehicles are substantially increased at several locations where right turn volumes are combined with indirect left turns that make one or more right turns.
- The QR intersection eliminates the need for left-turn lanes at the main intersection, which frees up ROW compared to a conventional intersection. This ROW can be used for multimodal facilities in the form of sidewalks, bicycle lanes, or transit facilities.
- At the main intersection, pedestrian walk phases can be shorter, as curb-to-curb crossing distances are shortened not having to cross multiple left-turn lanes. Furthermore, as cycle lengths can be shorter at QR intersections compared to conventional intersections, pedestrians and bicyclists wait time is also shortened (more pedestrian cycles per hour).

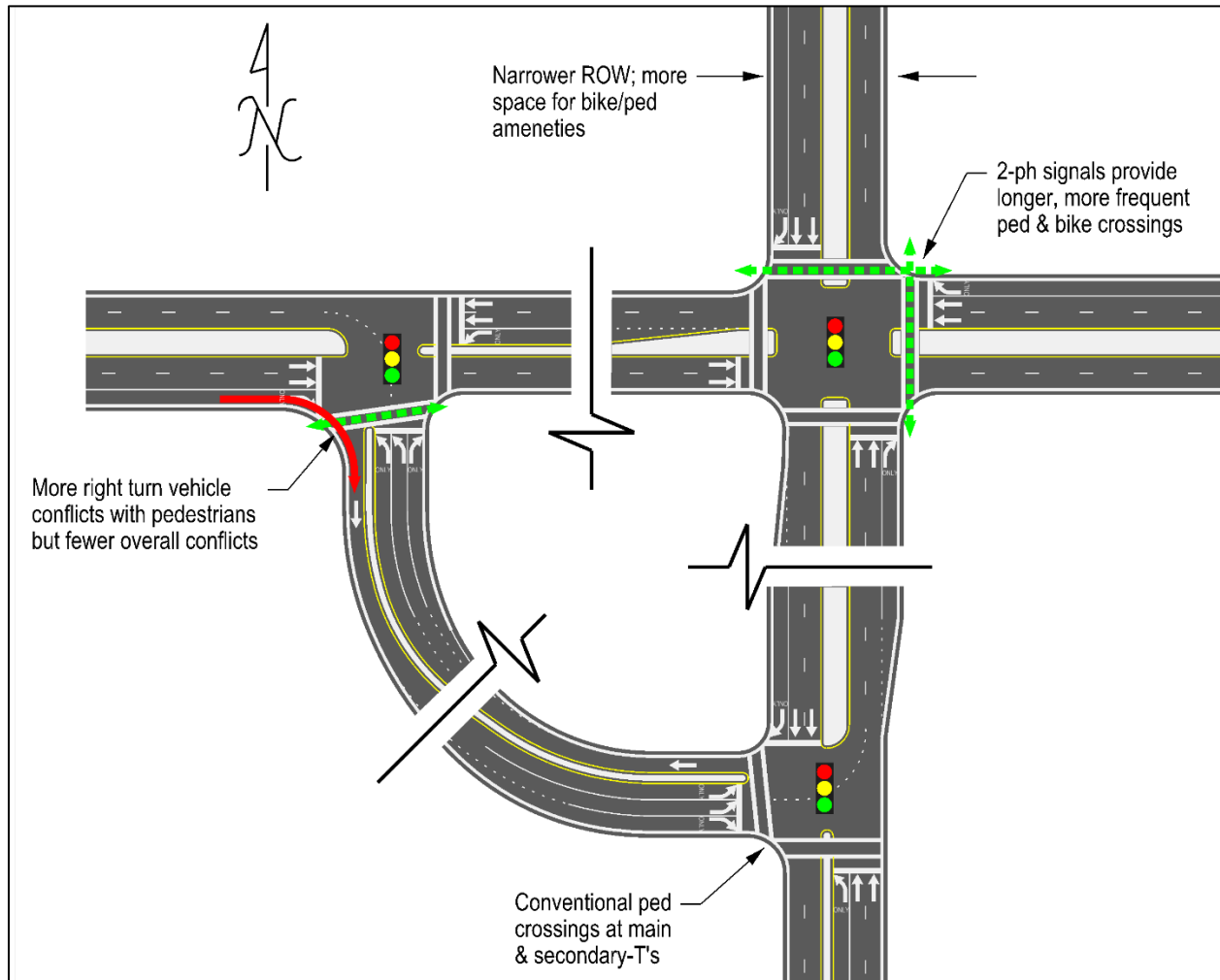

© NCDOT

Figure 29. Graphic. Multimodal considerations.

- As QR intersections are often at locations with balanced approach volumes, pedestrian walk phases can be more equally distributed, providing added time for pedestrians, particularly pedestrians with disabilities.
- Note that only two of three crosswalks are provided at the secondary T-intersections. Eliminating interior crosswalks limit pedestrian interaction with left-turning vehicles leaving the quadrant roadway at both secondary T-intersections. The placement and design of crosswalks is discussed in greater detail in chapter 7.

Anticipating Multimodal Needs, Behavior, and Patterns

A fundamental challenge in developing any new intersection form is deciding how to best provide for pedestrian and bicycle movements and anticipating the *desire lines* between different origins and destinations for these modes (e.g., how bicyclists, pedestrians, heavy vehicles, and transit vehicles travel through the intersection). Forecast volumes for non-motorized users are rarely available, and if they are, they typically do not capture travel patterns within the intersection.

Most QR intersections constructed to date feature pedestrian facilities and some provide separate bicycle facilities. For retrofit sites, the existing pedestrian and bicycle facilities were improved with construction of the QR intersection. QR intersection improvement projects at both the Huntersville, North Carolina and Front Royal, Virginia locations added sidewalks and pedestrian crosswalks on all roadways, and the Front Royal project also added a separate in-street bicycle facility on US-340/522. At three of these four QR intersection sites, the construction of multimodal facilities was a priority for agencies, garnering positive feedback from local residents and users for inclusion at each facility.

At major intersections in suburban areas, pedestrian improvements and connectivity can sometimes lag land use development, as land uses are often required to only make improvements along their direct frontage and not provide connectivity through the intersection. QR intersections are well suited in built-up environments where development is already present in one or more intersection quadrants and where roadway capacity has not been improved in recent years. Therefore, early consideration and provision for pedestrian, bicycle, transit, and heavy vehicle movements should be a priority consideration for QR intersection projects where not already present and should be accounted for early in the planning and design phases.

The remainder of this chapter describes the unique characteristics of the primary multimodal modes of pedestrians, bicyclists, transit, and heavy vehicles that should be considered when analyzing and designing QR intersections. Transportation professionals need to work to identify and understand the needs of these various user groups to produce a balanced design that serves them all.

PEDESTRIANS

The inclusion of pedestrian facilities should receive attention and consideration throughout the design process. This section describes QR intersection design features, considerations, and trade-offs relating to the pedestrian mode.

Pedestrian facilities should be planned, designed, and constructed to emphasize pedestrian convenience and safety, which is achieved through appropriately sized sidewalks, vertical and horizontal separation from adjacent travel lanes, minimized pedestrian crossing distances, clearly defined pedestrian paths, adequate time to cross, and low vehicular speeds. Landscaping and other aesthetic treatments can contribute to a positive pedestrian experience.

Potential benefits for pedestrians at QR intersections include:

- Reduced pedestrian-vehicle conflict points.
- Shorter pedestrian crossing distances and safe refuge areas (less pedestrian exposure).
- Longer, more frequent pedestrian crossings.

Pedestrian-Vehicle Conflict Points

Pedestrians crossing a QR intersection encounter fewer conflicting traffic streams than at a conventional intersection. At a conventional intersection, pedestrians cross the street with one-stage or two-stage crossings during the vehicle phase of the adjacent street. Figure 30 shows pedestrian conflict points with vehicle movements that pedestrians experience at a conventional intersection.

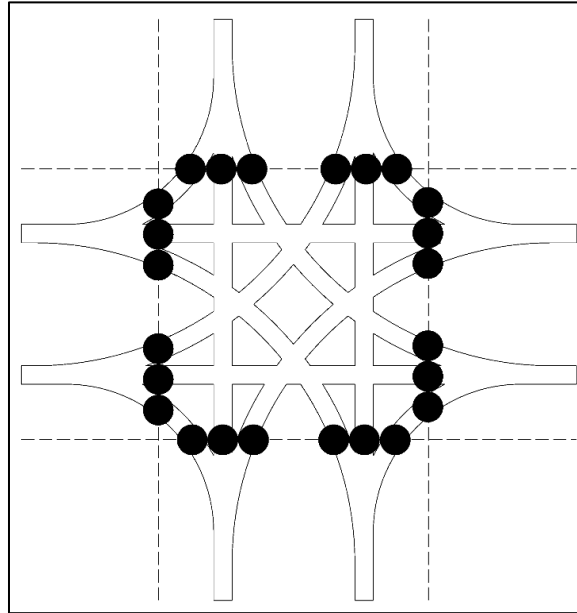

© NCDOT

Figure 30. Graphic. Pedestrian-vehicle conflict points at a conventional intersection.

Figure 31 shows pedestrian conflict points with traffic movements at a QR intersection. At the main intersection, crosswalks can be marked across all intersection legs, as at a conventional intersection. Pedestrians at a QR intersection cross one roadway during the through and right-turn signal phase for the other roadway, leaving only pedestrian-vehicle conflicts with opposing street right-turning vehicles making a right-turn-on-red (RTOR).

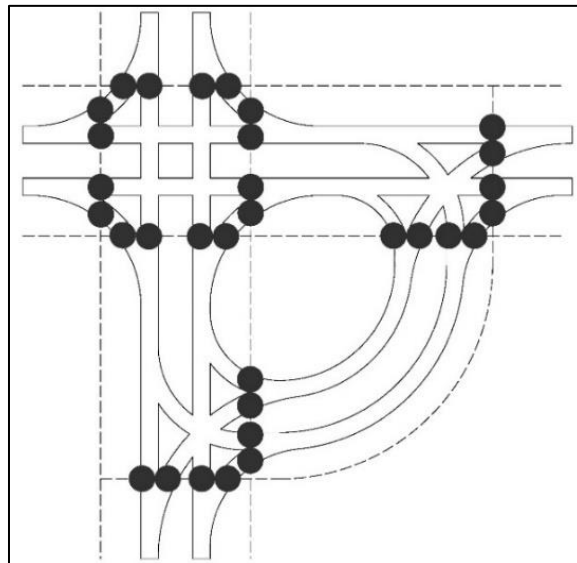

© NCDOT

Figure 31. Graphic. Pedestrian-vehicle conflict points at QR intersection.

Because the QR includes three signalized intersections, the total number of vehicle-pedestrian conflict points at a QR intersection (32 conflict points) is greater compared to a conventional intersection (24 conflict points). However, the exposure to pedestrians in the crosswalk is

reduced for a QR intersection since left-turn movements are eliminated at the main intersection, and the length of the crossings are often reduced compared to conventional intersections. Due to be published in 2020, NCHRP 7-25 will provide procedures to evaluate pedestrian and bicycle operations and safety for a variety of alternative intersection forms including the QR intersection.

Figure 32 shows the eight sidewalk origins and destinations (A through G) at a QR intersection. Assuming there are no pedestrians making U-turns and none destined for the interior of the quadrant roadway, each of the 8 origins have 6 potential destinations, for a total of 48 pedestrian origin-destination (O-D) pairs. Of those 48 pairs, only 8 O-D paths (17 percent) require pedestrians to cross an additional crosswalk compared to a conventional intersection. These paths are: A to F, B to F, C to G, and D to G (and their reciprocals). All other pedestrian O-D pairs make the same number of intersection crossings compared to a conventional intersection and are benefited by having shorter crossing distances (less exposure to vehicles) and longer walk times. In addition, two O-D pairs can walk along the quadrant roadway (E to G, E to H, F to G, and F to H and their reciprocals), shortening the distance a pedestrian must travel.

Note that at the secondary T-intersections in figure 32, only two of three approaches include crosswalks. Omitting the one particular crosswalk eliminates pedestrian conflicts with vehicles turning left out from the quadrant roadway. Greater details on T-intersection crosswalk placement is included in chapter 7.

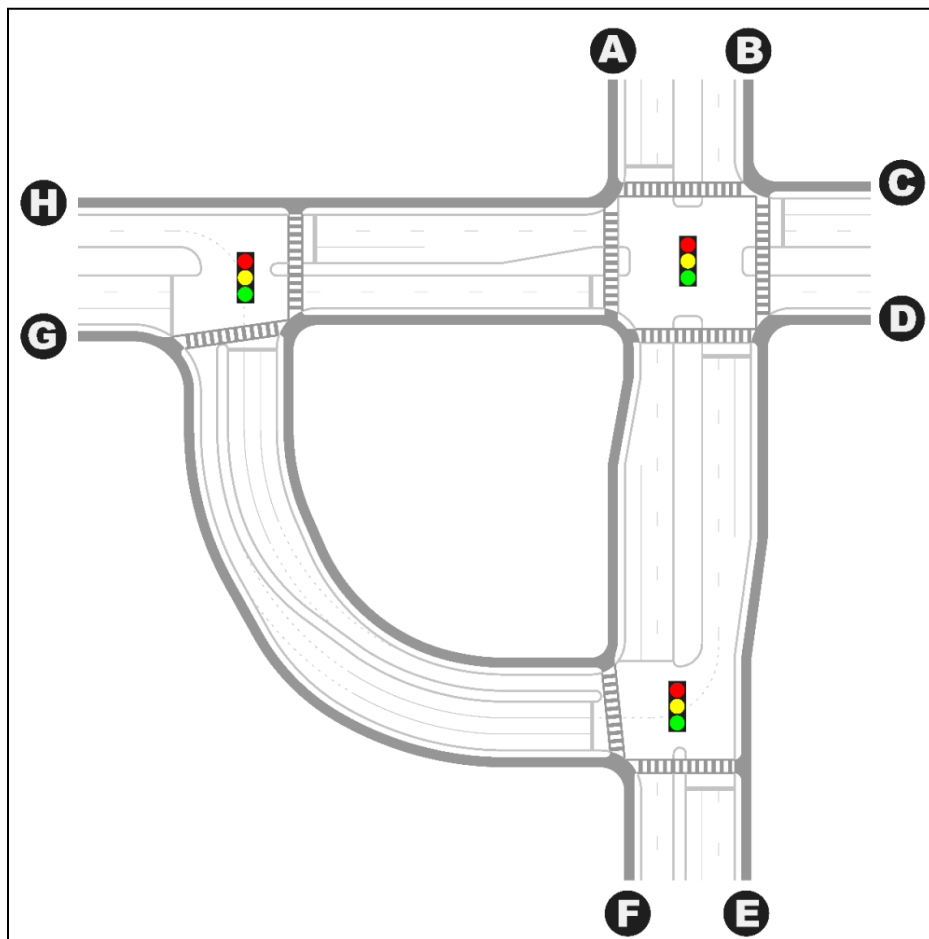

© NCDOT

Figure 32. Graphic. Pedestrian movements through a QR intersection.

Pedestrian Crossing Distances

Because there are no left-turn lanes at the main intersection of a QR intersection, the curb-to-curb pedestrian crosswalk distance is typically shorter. At a conventional intersection, pedestrians must cross the width of the through lanes of travel in both directions, plus a single or dual left-turn lane(s) and often a right-turn lane. This length increases the exposure time for pedestrians as well as the length of the pedestrian walk/don't walk phase. Figure 33 and figure 34 compare the pedestrian crossing distance at the main intersection of a QR intersection with a conventional intersection (both assuming two through lanes in each direction and 8-ft medians). The pedestrian crossing distance under the QR intersection (figure 33) is approximately 80 ft compared to the approximate 104 ft to cross at a conventional intersection (figure 34), a 30-percent reduction in pedestrian exposure to vehicular traffic.

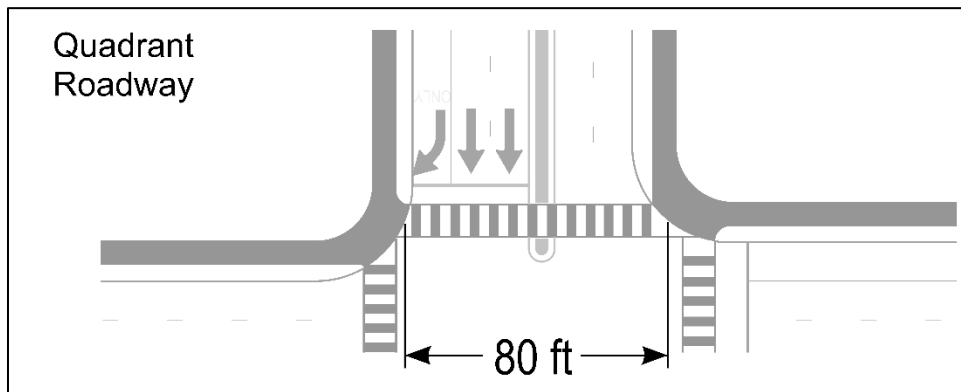

© NCDOT

Figure 33. Graphic. Conventional intersection crosswalk distances.

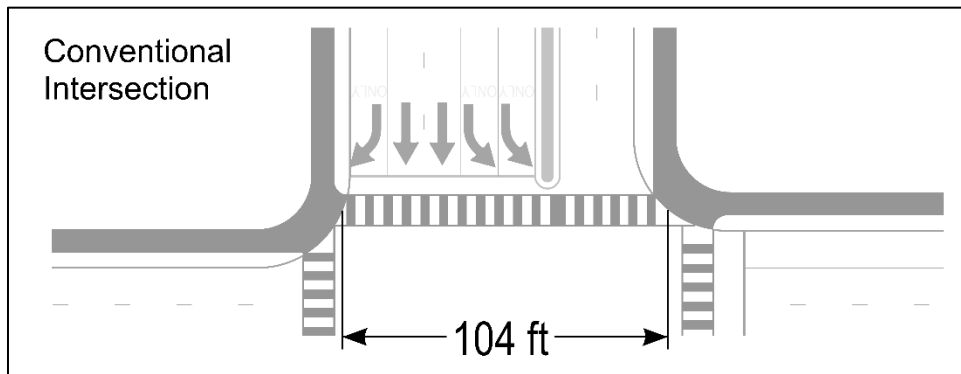

© NCDOT

Figure 34. Graphic. QR intersection crosswalk distances.

At conventional intersections, intersection width can dictate the length of signal phases to allow pedestrians to safely cross during the adjacent street through vehicle phase. Conventional intersections often display very short “walk” phases to reduce the pedestrian impacts to signal phases and cycle lengths. The shorter crosswalk lengths at a QR intersection allow greater phase flexibility and pedestrian safety to be built into each signal cycle. At QR intersections, since there are only two signal phases (that are often close to being equal), pedestrians can receive longer “walk” times, and crossing lengths are less of an impact to vehicle signal phase lengths.

Pedestrian Crossing Time

A third benefit to pedestrians is gained by the two-phase signal operations at the main intersection. Two-phase operations can result in a shorter signal cycle length (meaning more pedestrian crossing phases per hour), while providing additional walk time for pedestrians to cross the intersection. Figure 35 shows the pedestrian “walk”, flashing “don’t walk” and “Don’t Walk” indicator progression for pedestrians crossing Street 1 at a conventional intersection. Figure 36 shows that QR intersections can increase the time allotted for pedestrian crossing both streets during each signal cycle despite an overall decrease in signal cycle length (CL). The greater number of signal cycles per hour also provides more pedestrian crossing time per hour and a shorter wait time for pedestrians between signal cycles.

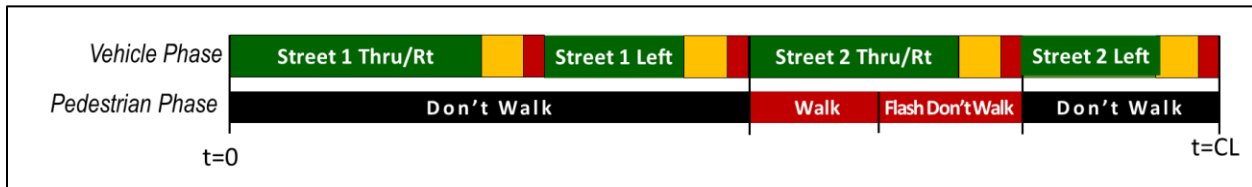

© NCDOT

Figure 35. Graphic. Pedestrian walk phases at a conventional intersection.

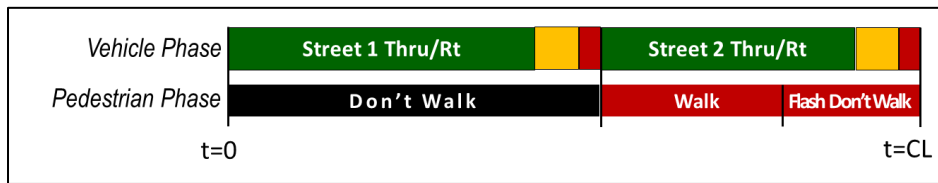

© NCDOT

Figure 36. Graphic. Pedestrian walk phases at a QR intersection.

Pedestrian-Focused QR Intersection Design

Pedestrian safety and comfort are enhanced by reduced vehicle speeds, good driver-to-pedestrian sight distances, and appropriate crosswalk locations. At QR intersections, there are opportunities at both the crossing and secondary T-intersections for pedestrian-focused designs through the use of reduced curve radii, enhanced pedestrian crossings, and other geometric details. Key concepts underlying pedestrian-focused design of QR intersections include:

- Tighten vehicle curve radii to reduce speeds at the crosswalk. Lower vehicle speeds have been linked in research to increased driver yielding rates as well as lower risk of serious injury or death for the pedestrian in the case of a crash.
- Provide adequate sight distance for vehicle approaches to crosswalks by limiting roadside obstacles. Improved vehicle sight distance also provides enhanced pedestrian sight distance to make adequate gap crossing decisions at unsignalized crossings.
- Where right-turn channelizing islands are needed, provide one vehicle length of storage downstream of the crosswalks for yield-controlled vehicle movements. Similar to the crosswalk placement at roundabouts, this separates the driver decision points of yielding to pedestrians at the crosswalk and screening for gaps at the yield sign. It also prevents drivers waiting at the yield line from blocking the crosswalk with their vehicle.

- Locate crosswalks behind the stop bar for signalized vehicle turns, consistent with driver and pedestrian expectations at signalized intersections.

Typical QR intersections include signalization at all three intersections, with possible variations such as the use of roundabouts described in the earlier chapter. Lighting of all intersections and crosswalks is often cost-feasible and generally beneficial to pedestrian safety and should be included in cost estimates to benefit pedestrian visibility and safety.

ADA and PROWAG Accessibility Considerations

Accessibility was previously described in chapter 2 in the broader context of considering a project's built and planned environment and the ability for various users to approach a desired destination or potential opportunity for activity using highways and streets (including the sidewalks and/or bicycle lanes provided within those ROW). In this section, accessibility is explicitly focused on the policies related to American with Disabilities Act (ADA) and Public Rights-of-Way Accessibility Guidelines (PROWAG). Special consideration should be given to pedestrians with disabilities, including accommodating pedestrians with vision or mobility impairments. Being relatively new on a national level, specific guidance for "Accessible QR intersections" is not yet available. However, general accessibility principles can be borrowed from other forms of intersections and applied here. The United States Access Board provides many additional resources on accessibility and specific requirements for Accessible Public Rights of Way, which the transportation professional should refer to and become familiar with, in addition to AASHTO guidance.⁽¹⁸⁾

All pedestrians—but especially those with vision, mobility, or cognitive impairments—may benefit from targeted outreach and informational material created with pedestrians in mind. These outreach materials include information on crosswalk placement and intended behavior, as well as answers to frequently asked questions. For blind pedestrians, materials need to be presented in an accessible format with descriptions of distinct features of the QR intersection.

Pedestrians with vision, mobility, or cognitive impairments should find crossing QR intersections similar to crossing a conventional intersection. Either intersection form requires crossing multiple through travel lanes and generates conflicts with right-turning vehicles. In general, intersection crossings can be accommodated with traditional design techniques. The cues that pedestrians with vision impairments rely on to cross intersections, such as the sound of traffic parallel to their crossing, are similar in QR and conventional intersection forms. The direct crossing paths of a QR intersection are relatively easy and convenient to use. All pedestrians will experience two-phase signal timing and a reduced number of conflicting traffic streams.

The basic principles for accessible design can be divided into the pedestrian walkway and the pedestrian crossing location. For the pedestrian walkways, the following considerations apply:

- Provide sufficient space (length, width) and recommended slope rates for wheelchair and other non-motorized users such as people pushing strollers, walking bicycles, and others.
- Construct an appropriate landing with flat slope and sufficient size at crossing points.

For pedestrian crossing locations, these additional considerations apply:

- Provide curb ramps and detectable warning surfaces at the transition to the street.
- Separation of the pedestrian path from the back of curb and delineation of the pedestrian route using curbing, vegetative, or other type of buffer.

- Provide accessible pedestrian signals with locator tone at signalized crossings.
- Locate push-buttons to be accessible by wheelchairs and adjacent to the crossing at a minimum separation of 10 ft.
- Use audible speech messages where spacing is less than 10 ft, or where additional narrative for the expected direction of traffic is needed.
- Align crosswalk landings to the intended crossing direction.
- Crosswalk width through the intersection should be wide enough to permit pedestrians and wheelchairs to pass without delay from opposing directions.
- Use high-visibility crosswalk markings (this is important for low-vision pedestrians and can make the crosswalk more detectable to motorists).

Figure 37 illustrates a QR intersection pedestrian crossing in Front Royal, Virginia that includes many of the aforementioned considerations.



© NCDOT

Figure 37. Photo. Example of pedestrian wayfinding provision via curbing.

BICYCLISTS

QR intersections are most often found in urban and suburban settings along arterials or other high-volume streets where bicycle accommodations are less likely to be included. However, the current trend in many communities is to integrate Complete Streets policies that include bicycle accommodations on all types of streets. Figure 38 illustrates bicycle lane accommodations at the Front Royal, Virginia QR intersection, including marked bicycle lanes on US-340/522.



© NCDOT

Figure 38. Photo. Bike lanes at Front Royal QR intersection.

At QR intersections, through and right-turning bicyclists receive higher percentages of green time at QR intersections compared to conventional intersections. Where vehicular right turns are in conflict with bicycle lanes, an increasingly common practice is to shift the right-turn lane to the right of the bicycle lane upstream of the signalized intersection, as illustrated in figure 39. This clearly identifies the conflict areas between though bicyclists and right-turning vehicles.

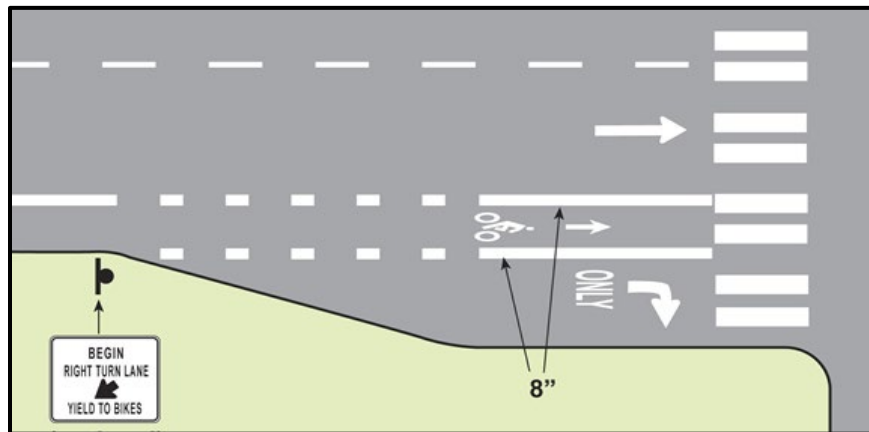

Source: FHWA

Figure 39. Graphic. Right-turn lane with bicycle lane.

Options for Bicycle Accommodation at QR Intersections

Three basic options exist for accommodating bicyclists at QR intersections. These options include providing:

1. Shared-lanes on one or both roadway, which may include the use of wider shoulders or bicyclists using the vehicular travel lane. For this option, “sharrow” markings can reinforce to motorists that bicyclists are legal roadway users.

2. A defined bicycle lane on one or both roadways through the QR intersection. For this option, pavement markings can reinforce to drivers that the bicycle lane is not a shoulder. Along higher-speed roads, buffered bicycle lanes are preferred.
3. A separated multi-purpose or shared-use path.

Each of these options may be viable in certain locations; the choice depends to a large extent on the expected use of the facility by bicyclists, the expected behavior of these bicyclists, location of local and regional destinations (schools, shopping, employment centers, parks), and the available ROW on both roadways. Without a bicycle lane, experienced bicyclists are likely to use the vehicular travel lanes while recreational bicyclists may use the sidewalk or vehicular lanes (depending on their speed differential with pedestrians and/or local bicycle ordinances).

As direct left-turn lanes are removed from the main intersection in a QR design, left-turning bicyclists have three options for navigating a QR intersection:

- A. **Bicyclists making a “two-stage left-turn” using bicycle box:** Bicyclists on both roadways approach the intersection and follow the vehicle signals. When receiving a green phase, the bicyclists proceed across the intersection and stop in a bicycle left-turn queue box on the right. When the crossing street receives a green indication, bicyclists proceed along with the crossing street traffic. Signage on both streets should reinforce the auto no left-turn movement against crossing autos and bicycles. One option is to use R3-5a mandatory movement lane control signs (i.e., straight ahead only) for the auto lanes. This option is most desirable for bicyclists. Figure 40 illustrates the two-stage bicycle left turn placement. Figure 41 illustrates a typical in-street bike-box pavement marking.



Source: FHWA

Figure 40. Graphic. Bicycle two-stage crossing path.



Source: FHWA

Figure 41. Graphic. Bicycle in-pavement bike box.

- B. **Bicyclists cross following “pedestrian rules”:** Bicyclists approach the intersection and instead of traveling through based on the vehicle indications, exit the street to the right and follow the “walk”/ “don’t walk” indications (just as a pedestrian would).
- C. **Bicyclists cross following “vehicle rules” using the quadrant roadway:** Under this option, bicycle lanes would be included on both sides of the quadrant roadway. Each bicycle left turn approaching from all four directions would take a different path. Two of the paths may be considered intuitive to bicyclists, while the other two paths create two-stage crossings at the secondary T-intersections. Figure 42 and figure 43 illustrate each bicycle movement path and each movement path is described following each figure.

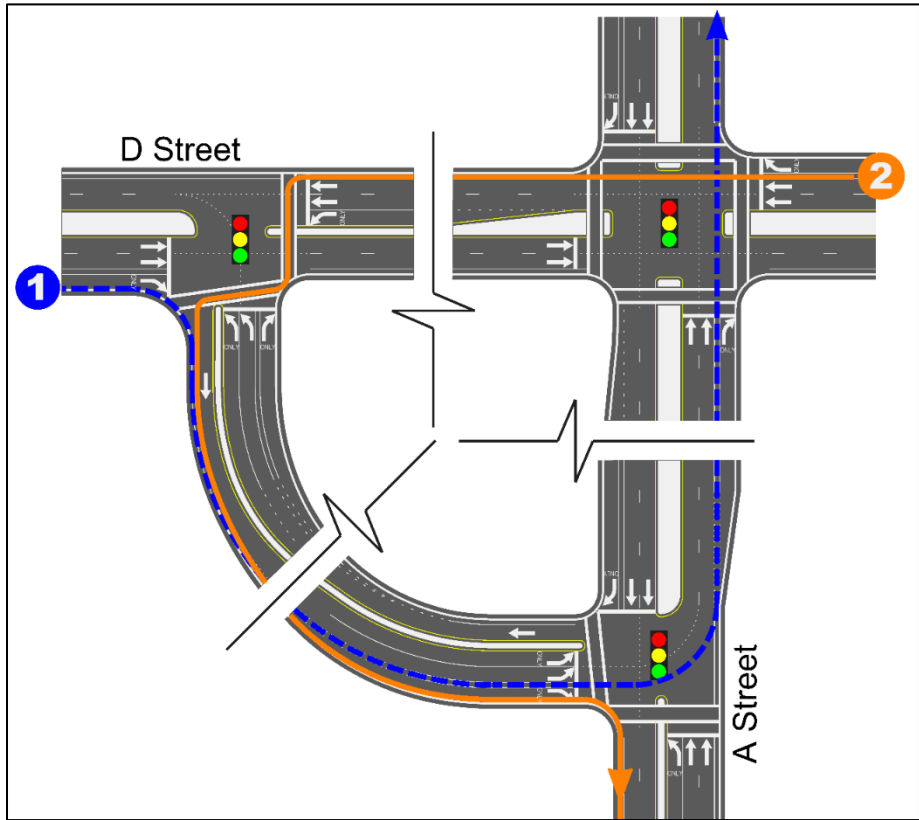

© NCDOT

Figure 42. Graphic. D Street bicyclists left turns following quadrant roadway.

Path 1: Bicycles turn right at the first T-intersection onto the quadrant roadway with right-turn vehicles under signal control (or as RTOR) and then turn left at the second T-intersection with the left-turn vehicle phase. All bicycle movements operate under protected signal phases, but the total distance traveled by bicycles is increased compared to the conventional two-stage option.

Path 2: Bicycles pass through the main intersection and turn left by making a two-stage crossing with pedestrian movements on the near and quadrant sides of the first T-intersection. These movements are inconvenient for experienced bicyclists who must cross with pedestrians and may wait for crossing phases at two locations. Bicycles would then traverse the quadrant roadway then right at the second T-intersection with right-turn vehicles under signal control (or as RTOR). All bicycle movements operate under protected signal phases, but the total distance traveled by bicycles is increased compared to the conventional two-stage option.

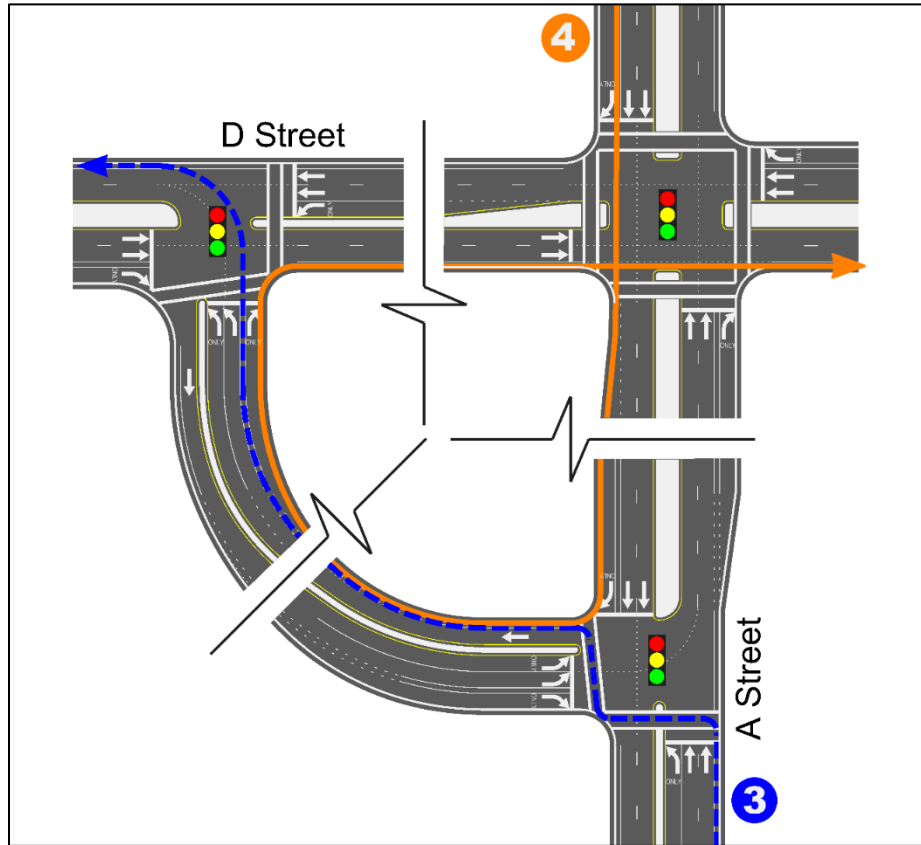

© NCDOT

Figure 43. Graphic. A Street bicyclists left turns following quadrant roadway.

Path 3: Bicycles turning left at the first T-intersection do so by making a two-stage crossing on the near and quadrant sides of the T-intersection, crossing with pedestrian movements. These two movements are inconvenient for experienced bicyclists who must cross with pedestrians and may wait for crossing phases at two locations. Bicycles would traverse the quadrant roadway then turn left at the second T-intersection with the left-turn vehicle phase. All bicycle movements operate under protected signal phases, and the total travel distance is slightly reduced compared to the conventional two-stage option.

Path 4: Bicycles pass through the main intersection and turn right onto the quadrant roadway with right-turn vehicles under signal control or as RTOR and then turn right at the second T-intersection with right-turn vehicles under signal control or as RTOR. All bicycle movements operate under protected signal phases, but the total distance traveled by bicycles is increased compared to the conventional two-stage option and bicyclists travel through the main intersection twice.

Of the three options for bicycle left turns, the “two-stage left-turn” option is the most natural for bicyclists and the most likely to be obeyed. The “pedestrian rules” option can be considered when upgrading sidewalks to multi-use paths, or when an otherwise off-street bicycle path crosses the street at the intersection. The “vehicle rules” option is least desirable, as several movements require two-stage crossing at the secondary T-intersection (not meeting bicyclist expectations), bicycle travel distance is increased for most movements and there is additional cost to construct bicycle lanes on the quadrant roadway.

Bicycle-Pedestrian Conflicts

Potential pedestrian-bicycle conflicts exist in those cases where bicycles are expected to use the pedestrian walkway and sidewalk system. Just as there is a speed differential between motorized traffic and bicycles, there is also a speed differential between bicycles and pedestrians, unless bicyclists choose to dismount on the sidewalk. The minimum width of a shared-use path is 10 ft except in very rare circumstances. Wider paths, or fully separated bicycle paths, may be needed in cases where high pedestrian and bicycle volumes are expected at a QR intersection, such as when a path or trail system goes through an interchange.

TRANSIT VEHICLE CONSIDERATION

Rail or Bus Rapid Transit

The QR intersection does not introduce any unique benefits or fatal flaws for light-or heavy-rail transit (LRT or HRT) and bus rapid transit (BRT) vehicle crossings. However, if choosing which intersection quadrant to place the QR is an option, there would be an advantage for the rail crossing to be located along the top end of a secondary T-intersection so that there is no track crossing the quadrant roadway, as illustrated in figure 44 and figure 45.

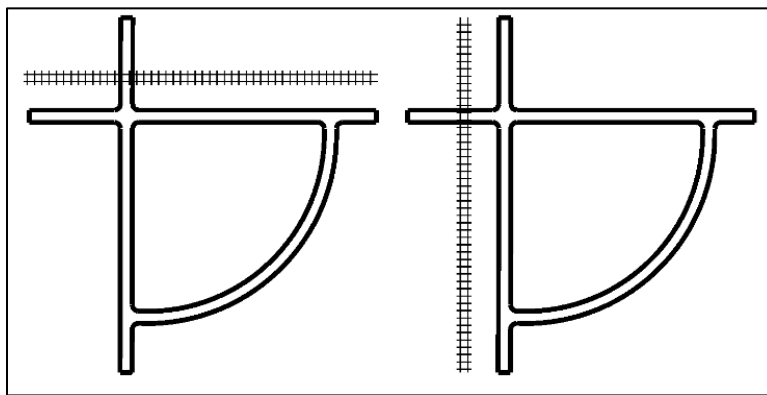

© NCDOT

Figure 44. Graphic. Desirable QR intersection rail crossings.

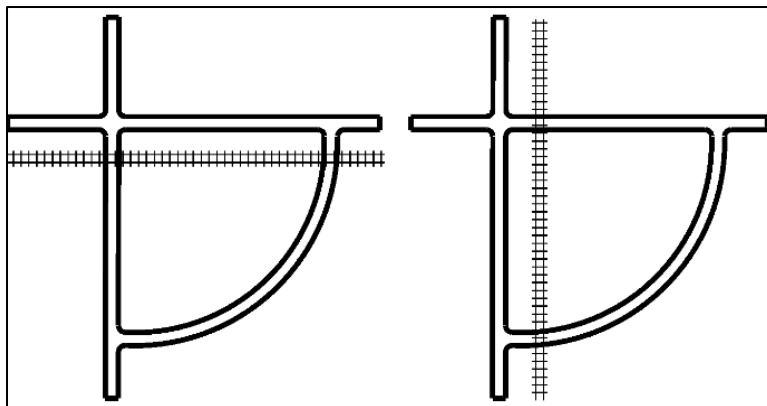

© NCDOT

Figure 45. Graphic. Less desirable QR intersection rail crossings.

This would also help preserve the T-intersection operations, as a fourth leg would create an undesirable additional track crossing. The transit line crossing of the main intersection would be planned and designed similar to transit crossings at any conventional intersection. The QR main intersection has a slight advantage because the rail line would not have to cross any left-turn lanes. A special phasing plan would have to be included for all three intersections that would preempt the roadway crossing the track and would systematically clear the intersection after the crossing is cleared.

At the time of this publication, there are no known examples of LRT or BRT corridors running through a QR intersection.

Bus Transit

The QR intersection does not introduce any unique movements for buses traveling through the intersection compared to a conventional intersection. Buses on the major street can operate using the right lane on both intersecting roadways and make stops before or after the main intersection in the same manner as conventional intersections, while receiving more green time and incurring less delay. Bus routes turning left at the intersection would follow the rules of the QR intersection, which will add additional travel distance for buses, but typically will not increase the overall travel time for buses. There is an advantage to left-turning buses. At a conventional intersection, left-turning buses must leave the right (curb) lane and weave across through lanes to gain access to left-turn lanes at the main intersection. Under a QR intersection, two of the left-turn movements allow buses to stay in the right lanes and use the quadrant roadway to complete the left-turn movement.

Bus Stop and Transfer Locations

If transit service is only provided along one of the intersecting roadways, providing a far-side bus stop downstream of the secondary T-intersection is preferred (including a bus-bypass lane as possible) to allow buses to take advantage of signal progression, support green-extension transit signal priority treatments and avoid blocking right-turn movements. If transit service is provided on both streets, then transfer opportunities between bus lines should also be considered. This may involve a combination of a nearside stop on one street and a far-side stop on the other street, allowing transfer movements to be made by simply walking around the corner of the intersection. In that case, buses stopping at a nearside stop in a right-turn lane should be exempted from the right-turn requirement and possibly provided with a queue-jump phase to assist them in leaving the stop. Figure 46 illustrates potential locations for the near-side and far-side bus stop locations.

Additionally, bus stops *may* be located on the quadrant roadway (if buses are not making through movements), where their stopping impact may be lessened compared to stops on the higher volume intersecting roadways. However, considerations should be given to the fact that bus stop locations on the quadrant roadway may be inconvenient and/or less intuitive for the pedestrian to discover and walk to the bus stop locations. Stops should not be located in any areas on the quadrant roadway where there is only a single lane, or where transit stops could block QR intersection operations.

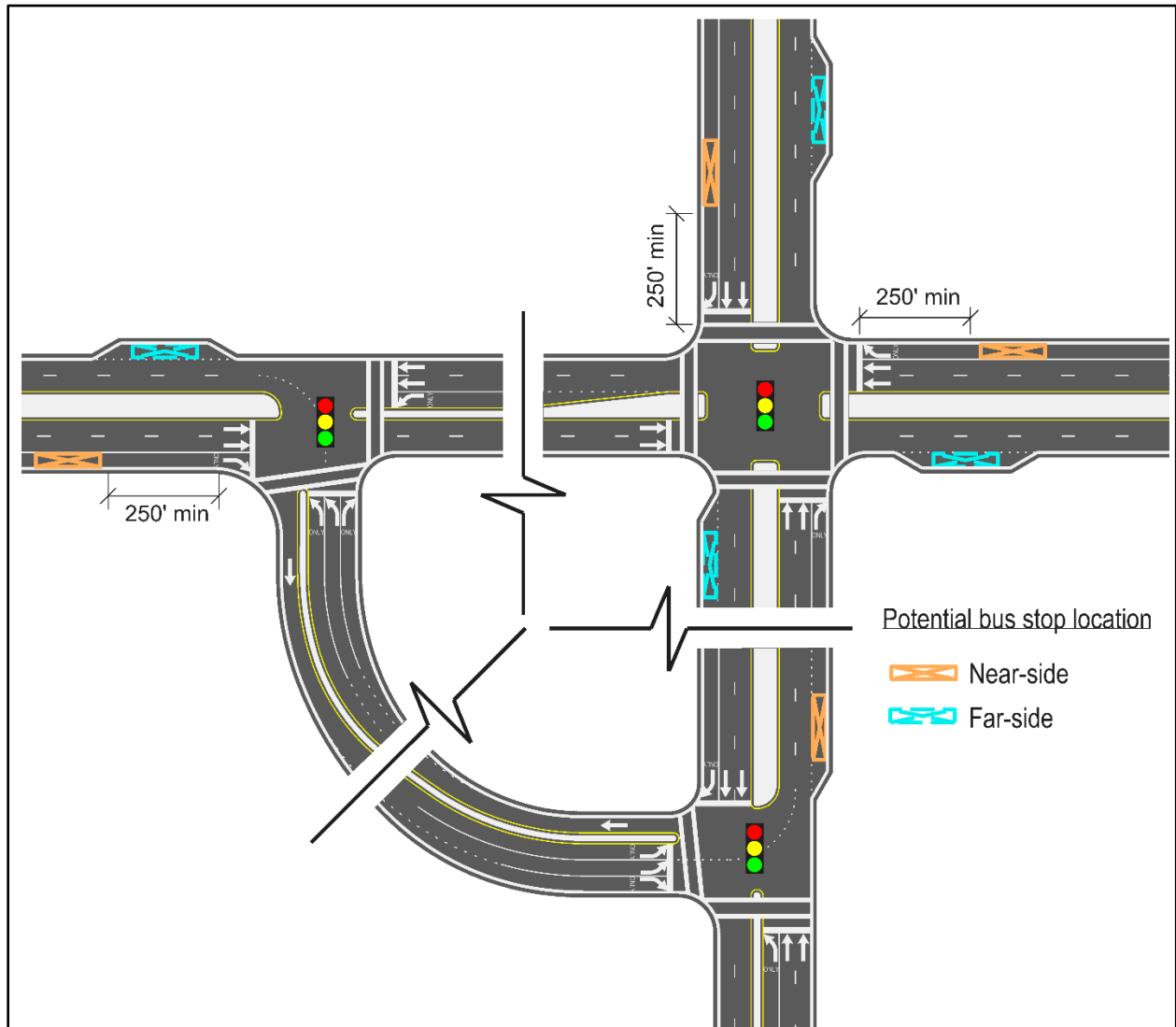

© NCDOT

Figure 46. Graphic. Potential bus stop locations.

HEAVY VEHICLE CONSIDERATIONS

The typical QR intersection can easily be designed to accommodate heavy vehicle movements at the main intersection, as heavy vehicles are not permitted to turn left at the main intersection, so focus should be on making the right-turn curb radii adequate for the design vehicle. The secondary T-intersections should be designed using truck turning templates according to the design vehicle (typically a WB-67 vehicle) to provide adequate turning radii and tracking for both the front and rear ends of trucks. This may impact the raised median nose design, turn lane widths, location, and curb radii and is typical for the design of any conventional T-intersection.

Should the QR intersection be located on an identified OSOW vehicle route, additional design modifications may be required, including wider lanes on the quadrant roadway, the use of mountable curbs and/or pavement bulb-outs as deemed necessary.

CHAPTER 4 — SAFETY

This chapter discusses safety principles and performance for QR intersections, including geometric design and human factors that potentially impact safety. Safety performance and observations are presented, as well as discussions of specific safety issues or concerns not typical at conventional intersections.

An appropriate level of safety assessment corresponding to the stage of the project development process (planning, alternatives identification and evaluation, preliminary design, final design, and construction) supports decisions about QR intersections. The analysis should be consistent with the available data, and the data should be consistent with the applied tools. Multimodal safety principles, including vehicle-pedestrian and vehicle-bicycle conflict points, accessibility, and crossing options, are discussed in chapter 3.

SAFETY PRINCIPLES

The change in safety performance associated with the conversion of a conventional intersection to a QR intersection is highly dependent on the existing conditions and expected change in traffic and turning movements. For example, converting two existing stop-controlled intersections to traffic signals has the potential to improve safety performance based on the crash modification factors (CMFs) presented in the Highway Safety Manual. However, this depends on the existing safety performance of the intersections since rear-end crashes are expected to increase while left-turn and angle crashes are expected to decrease. If there are relatively few left-turn and angle crashes, then the traffic signals may not provide a further safety benefit.

Concerns have been raised that QR intersections could increase crashes because two new signalized intersections are created. Based on the Highway Safety Manual, any new signalized intersection is expected to increase the frequency and potentially the severity of crashes compared to a similar roadway segment with no signalized intersection. The long-term expected frequency and severity of crashes at each new intersection is dependent on the specific geometric and operational characteristics such as traffic volumes, turning movements, presence of left- and right-turn lanes, permissive or protected left-turn phase, and allowance or prohibition of right-turn-on-red.

As described previously, another safety concern is related to vehicle-pedestrian conflict points. While total vehicle-pedestrian conflict points increase by 50 percent compared to a conventional intersection, the conflict point characteristics differ. As more QR intersections are constructed, data collection on the pedestrian safety experience will be of significant value.

However, there is some thought that QR intersections can improve intersection safety by reducing the overall number of vehicle-vehicle conflict points, changing the type of conflict points, and redistributing turning movements:

- **Reduced vehicle-vehicle conflict points:** There is a net change of two fewer vehicle-vehicle conflict points for a QR intersection compared to a conventional intersection: six fewer crossing conflict points, two more merging conflict points, and two more diverging conflict points.

- **Change in conflict types:** Crossing path crashes tend to be more severe than merging and diverging crashes. While there is an increase in the number of merging and diverging conflict points, there may be a net benefit in crash severity for vehicle-vehicle crashes because of the larger reduction in crossing conflict points.
- **Redistribution of turning movements:** Left-turn conflict points are transferred to the secondary T-intersections where the intersection volumes are lower, conflict points are fewer, and the intersection is smaller, making it easier for drivers to focus on potential conflicts (fewer decision points).

Also, as an indirect benefit, relocating and managing uncontrolled driveways near an intersection to the low-volume, low-speed quadrant roadway can result in overall safety benefits.

Reduced Vehicle-Vehicle Conflict Points

While crash data are often used to develop models or other tools that can ultimately help professionals make safety decisions about transportation facilities, crash data are often limited or completely unavailable for some types of facilities. In lieu of crash data, one often-applied strategy is to examine the number of conflict points at an intersection. While no mathematical relationship between conflicts and collisions has been clearly documented, conflicts are intuitively correlated with collisions and are often used as a surrogate measure, particularly to compare different intersection forms. It is common to consider both lane-by-lane conflicts and an aggregated conflict analysis that treats each movement as one lane; the latter approach will be presented here for the sake of simplicity.

Figure 47 and figure 48 identify the vehicle conflict points at conventional and QR intersections, respectively. By restricting direct left turns at the main intersection, QR intersections reduce vehicular intersection conflict points from 32 to 30. This includes the remaining conflict points at the main intersection (12) and the conflicts introduced by the QR at both secondary T-intersections (9 each), for a total of 30.

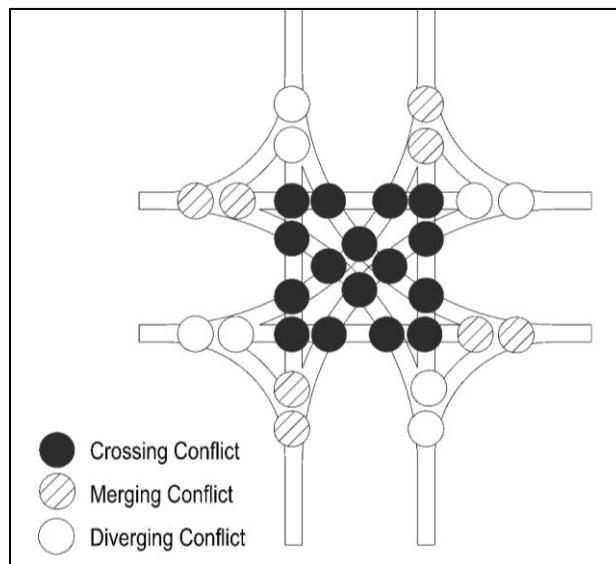

© NCDOT

Figure 47. Graphic. Vehicle-vehicle conflict points at conventional intersection.

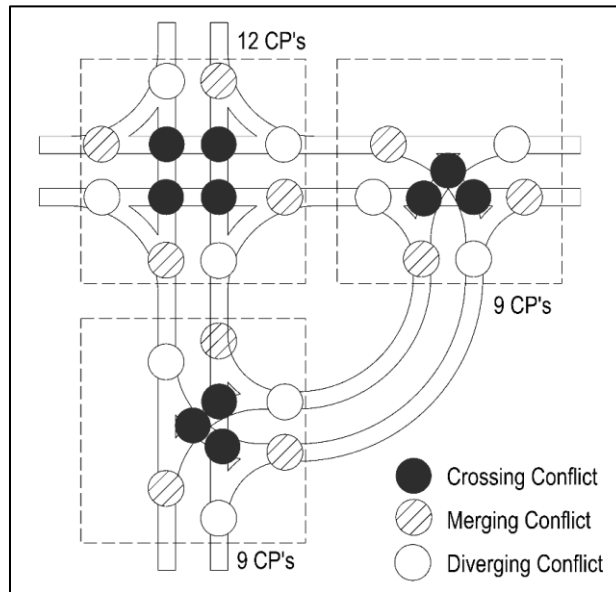

Figure 48. Graphic. Vehicle-vehicle conflict points at QR intersection.

Removing direct left turns at the main intersection also reduces some of the vehicular crossing conflict points that tend to be associated with higher crash severity, including left/through angle (or “T-bone”) collisions. As shown in table 4, the QR intersection reduces crossing conflict points from 16 at a conventional intersection to 10 over all 3 QR intersections (a 38-percent reduction). While no mathematical relationship between conflict points and crashes has been determined, conflict points are often used as a surrogate measure, particularly to compare different intersection.

Table 4. Conflict point comparison.

Intersection Type	Crossing	Merging	Diverging	Total
Conventional Intersection	16	8	8	32
QR Intersection*	10	10	10	30

*totals for all three intersections

If a roadway is connected as a fourth leg at either of the T-intersections (and no turns are restricted), the number of conflict points would substantially increase from 9 to 32 at the fourth leg / quadrant roadway full-movement intersection and from 30 to 53 for the overall QR intersection.

Human Factors Principles and Considerations

Based on human factors and driver expectation, motorists expect to make left turns at the main intersection. Drivers desiring to make a left turn do not expect the prohibition of direct left turns at QR intersections. Furthermore, motorists approaching a conventional intersection where they intend to make a left turn are accustomed to positioning their vehicles in the left lane(s) approaching the intersection, and motorists approaching an intersection where they intend to make a right turn position their vehicle in the right lane(s). Lastly, all of the left-turn movements and one right-turn movement are made at a different location than would be expected at a conventional intersection.

Figure 49 through figure 52 illustrate the QR intersection left-turn patterns from each approach (assuming the quadrant roadway is in the southeast intersection quadrant). Each of the four QR intersection left turn movements are unique and can have significantly different geometric and operational impacts. Using “Main” and “Quadrant” as references, the intersections that each left turn crosses through in order are:

- Main-Through, Quadrant-Left, Quadrant-Right (MT-QL-QR).
- Quadrant-Left, Quadrant-Left (QL-QL).
- Quadrant-Right, Quadrant-Left, Main-Through (QR-QL-MT).
- Main-Through, Quadrant-Right, Quadrant-Right, Main-Through (MT-QR-QR-MT).

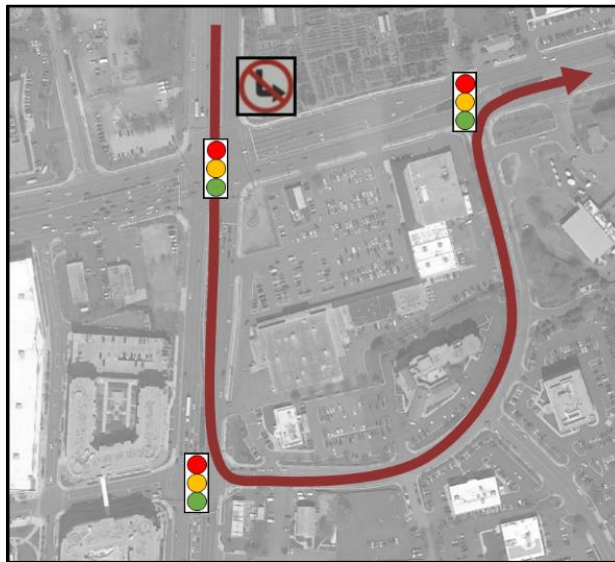

© NCDOT; Background image: © Google® Earth™ Accessed 2018

Figure 49. Graphic. QR intersection MT-QL-QR pattern.

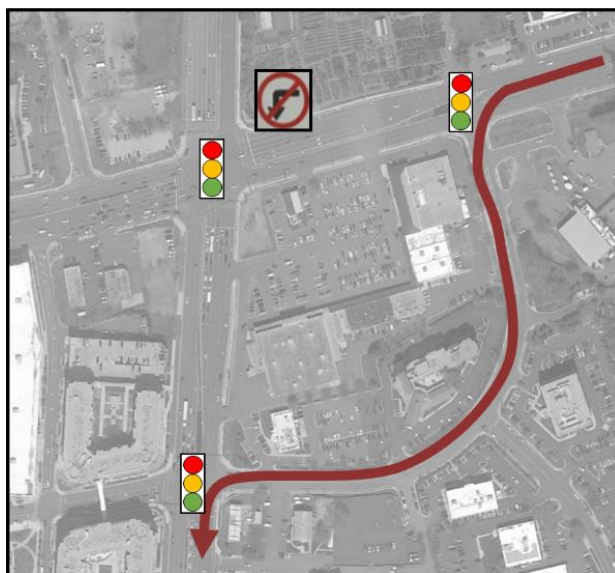

© NCDOT; Background image: © Google® Earth™ Accessed 2018

Figure 50. Graphic. QR intersection QL-QL pattern.

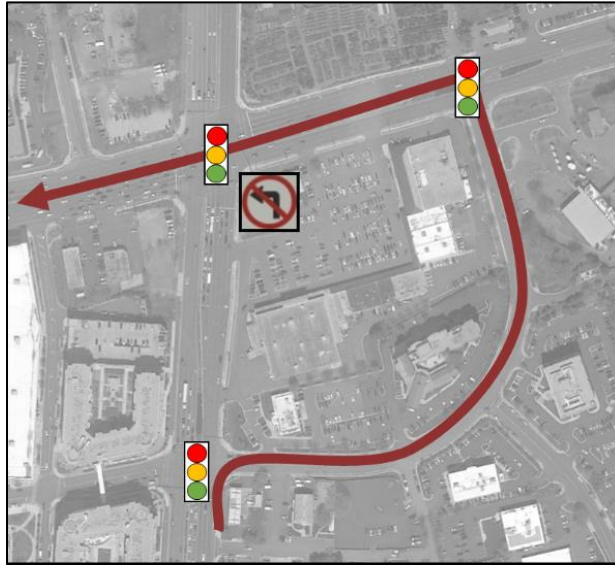

© NCDOT; Background image: © Google® Earth™ Accessed 2018

Figure 51. Graphic. QR intersection QR-QL-MT pattern.

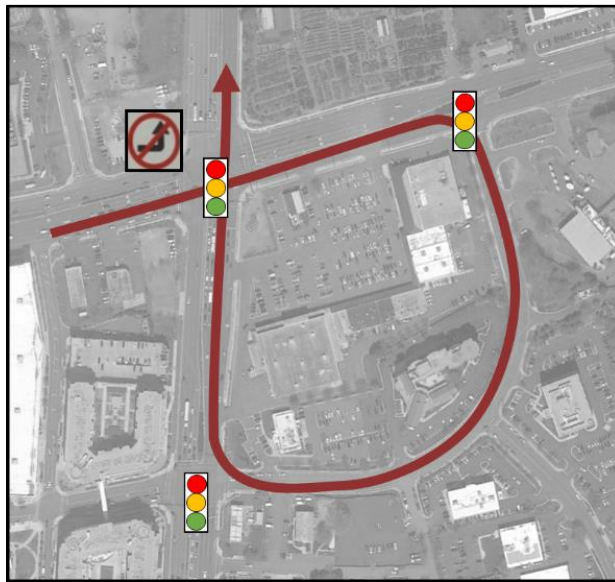

© NCDOT; Background image: © Google® Earth™ Accessed 2018

Figure 52. Graphic. QR intersection MT-QR-QR-MT pattern.

Examining the QR intersection left-turn patterns, some interesting human factor and driver expectation characteristics can be noted:

- For the two left-turn patterns NOT ending in MT (figure 49 and figure 50), the left-turn movements both meet the driver expectation of turning left from the left side of the roadway. Both movements require adequate signing and marking (discussed in greater detail in chapter 8) to instruct motorists to make their desired left-turn movement prior to or after the main intersection. Once on the quadrant roadway, additional signing and marking is needed to guide motorists through the completion of their left-turn movement.

- For the two left-turn patterns beginning with QR (figure 51 and figure 52), left turns are made by first turning right, which does not meet driver expectation of turning left from the left side of the roadway. The QR-QL-MT movement must be clearly communicated to motorists by ground-mounted signs (at minimum) or overhead signs (desirable) in advance of the secondary T-intersection, as discussed later in chapter 8.
- The MT-QR-QR-MT movement (figure 52) is the least intuitive and the most challenging movement to communicate to motorists. Therefore, this movement deserves the greatest attention in the project planning and design phases. Clear, concise signing must be provided far enough in advance of the intersection to direct motorists desiring to make a left turn to move to the right side of the roadway and proceed through the main intersection before making a right turn at the downstream secondary T-intersection. Without proper signing and marking, motorists expecting a conventional left turn are likely to approach the intersection on the left side of the roadway, realize the left-turn prohibition at the main intersection, and then try to cross one or more lanes to the right in a short distance to turn right onto the quadrant roadway. Every effort should be made to reduce occurrences of this challenging movement.

One potential way to mitigate the driver expectancy concern of the MT-QR-QR-MT movement is to build a U-turn downstream of the main intersection. Vehicles would pass through the main intersection, make a U-turn at a downstream location and then make a right turn (MT-UT-RT). This U-turn movement could be signed and marked to replace the MT-QR-QR-MT movement, or serve as an option to capture vehicles unfamiliar with the QR design, giving them the option to stay in the left-most lane approaching the secondary T-intersection. In either case, attention should be given to the design of the U-turn to ensure it has the geometric and operational capacity to accommodate the U-turn demand.

A second alternative would be to integrate the U-turn movement into the signal at the secondary T-intersection, similar to an RCUT intersection (as described in the FHWA RCUT Informational Guide).⁽²¹⁾ This hybrid concept would require full access control of the secondary T-intersection (no possibility of a fourth leg) and may require creation of a bulb-out to accommodate larger design vehicle U-turn movements, likely requiring additional ROW. The U-turn can be aligned with the beginning of the right-turn lane for the main intersection, providing continuity for the left-turn path. This QR / RCUT hybrid concept is illustrated in figure 53.

Note that this hybrid U-turn concept reduces the travel distance for left-turning vehicles from one approach compared to the typical QR intersection and would also replace a right turn movement with a through movement, resulting in added efficiencies.

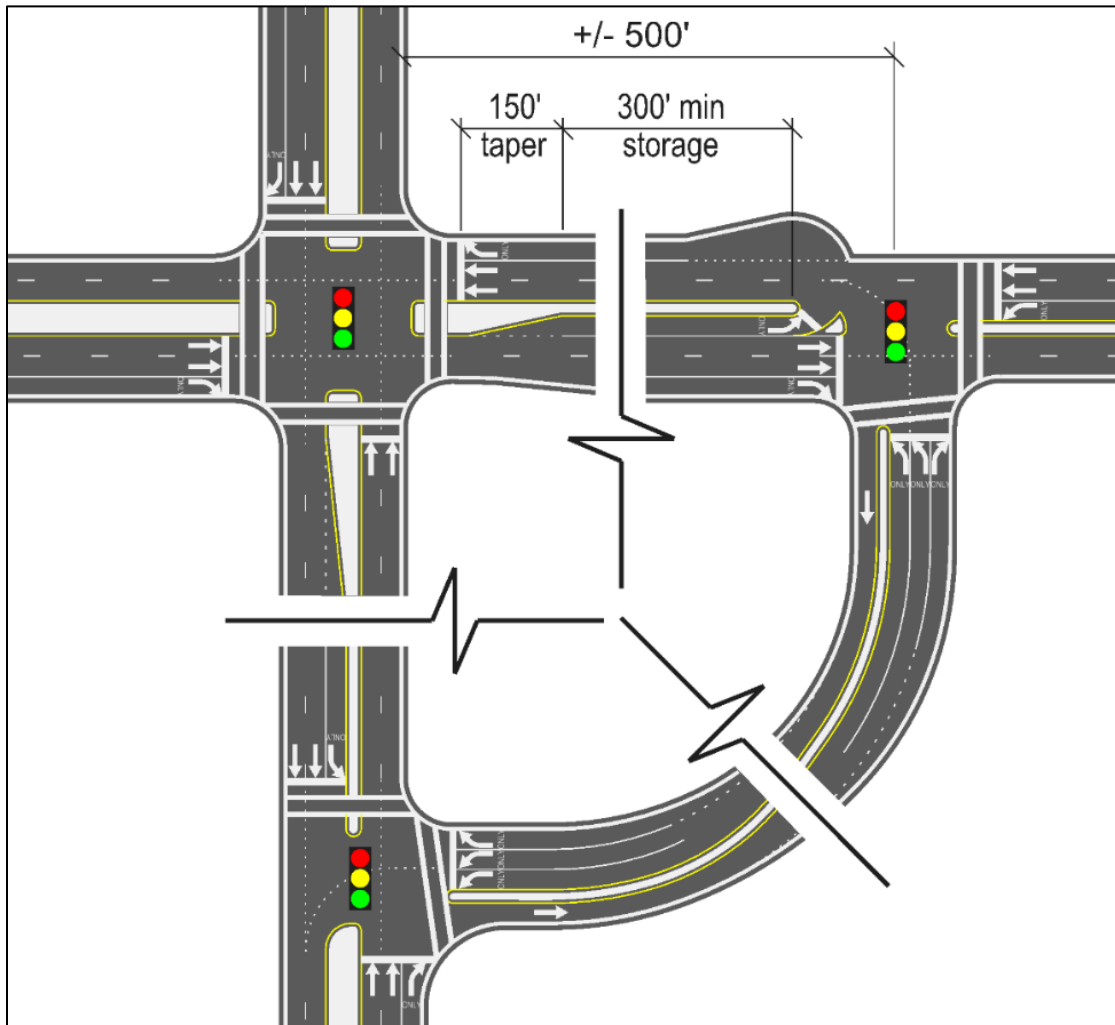

© NCDOT

Figure 53. Graphic. Hybrid QR intersection with U-turn at secondary T-intersection.

SAFETY CONCERNS

The QR intersection introduces some unique safety concerns not present at conventional intersections. These concerns are discussed in the following sections.

Potential for Violating Left-turn Prohibitions

While signing and geometric design can deter motorists from making direct left and/or U-turns at the main intersection, there is no physical barrier to prevent left turns or U-turns. Proper overhead and ground-mount signing and markings, combined with proper geometric design that positively guides vehicles through a QR intersection, are all important factors in discouraging prohibited left turns at the main intersection.

The QR is a relatively new design with limited implementations, and thus will not be common to drivers upon opening. Figure 54 shows illegal movements captured on video cameras shortly after the opening of the Huntersville QR intersection. Because of the learning curve associated with this new design, several QR intersection openings have included State or local police forces being used during the first days of operations to reinforce the turning prohibitions through the issuance of warnings and citations, providing a deterrence from improper intersection use.



© Town of Huntersville, NC

Figure 54. Photo. Traffic camera capture of illegal turns at QR intersection.

Intersection Spacing

The QR intersection introduces two new traffic signals—one on each roadway approaching the main intersection. The optimal signal spacing between main and secondary T-intersections is approximately 500 ft, depending on left-turn volumes and storage capacity needs. This spacing may not meet individual State or local jurisdiction signal spacing or median opening guidelines. Some State DOT policies require minimum signalized intersection spacing of 600 or 800 ft. Quadrant roadways that must meet 800 ft intersection spacing will impose significantly greater travel time and delays for motorists using the QR intersection. This is discussed in greater detail in chapter 7.

On the other end of the spectrum, excessively close intersection spacing may confuse motorists who may not be able to distinguish and make stopping decisions at successive intersections. In the two directions where motorists must pass through a secondary T-intersection then the main intersection (in that order of succession), it is important that there is sufficient braking distance for the second signal *after* the vehicle has cleared the first so that motorists can make independent decisions to stop or proceed through each intersection. Figure 55 presents the AASHTO formula for braking distance, which is based on approach speed, vehicle deceleration rates, roadway grades, and perception-reaction time.

$$SSD = 1.47 Vt + \frac{V^2}{30 \left(\frac{a}{32.2} \pm g \right)}$$

Figure 55. Equation. Calculation of safe stopping distance.

The parameters in figure 55 include:

- SSD = required stopping sight distance (SSD).
- V = vehicle speed, in mph.
- t = perception-reaction time, typically 2.5 seconds for design.
- g = roadway grade in percentage (downhill has negative value).
- a = vehicle deceleration rate, typically 11.2 ft/s.
- g = roadway grade (in decimal form).

The goal is for the SSD for the main intersection (SSD_1) to be lower than the distance between the main and secondary T-intersection. This would allow motorists to clear the first signal before reacting to the second, as illustrated in figure 56.

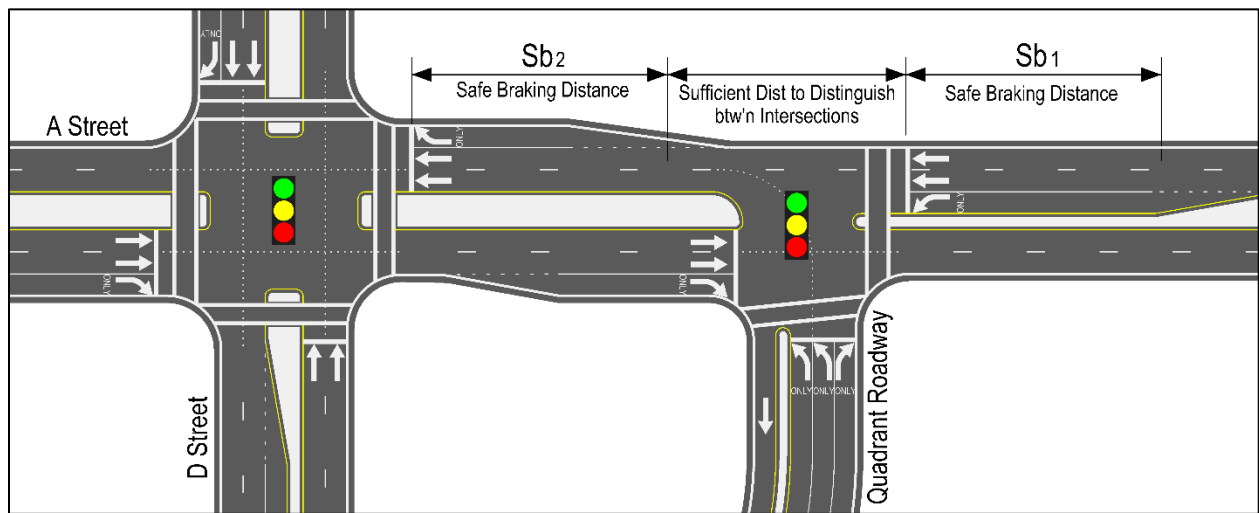

© NCDOT

Figure 56. Graphic. QR intersection braking distances.

Based on the stopping sight distance formula in the equation above, table 5 provides the calculated SSD based on roadway speeds and grades, which can be used to determine minimum spacing distance between the main and secondary T-intersections for a given location. Note that table 5 results are only meant to be used as a guide for planning QR intersection spacing in the project planning stage. The calculation of SSD for the purposes of determining signal clearance times should be performed in final design.

Table 5. Minimum intersection spacing by stopping sight distance.

Roadway Speed (mph)	Roadway Speed (ft/s)	SSD ₁ (ft) Grade=0%	SSD ₁ (ft) Grade=3%	SSD ₁ (ft) Grade=-3%
35 mph	51 ft/s	246	237	257
40 mph	59 ft/s	300	288	315
45 mph	66 ft/s	360	344	378
50 mph	74 ft/s	423	404	446
55 mph	81 ft/s	492	469	520

Queue Storage

Another design and safety consideration for QR intersections is providing sufficient queue lengths to reduce the possibility of queues backing up into the through lanes and particularly the crossing or secondary T-intersection. Sufficient queue storage is most critical in three areas of a QR intersection, as illustrated in figure 57 and described below.

1. Downstream left storage between intersections. The left-turn storage capacity on D Street is governed by the distance between the crossing and secondary T-intersection. To maximize storage length, the turn-lane taper begins just downstream of the main intersection. The QR signal phasing provides more green time for the left-turn movement and more cycles per hour compared to a conventional intersection, and in most cases, a single left turn with adequate storage should meet left-turn demands. However, since the left-turn lane is downstream of the main intersection, left-turn vehicles that depart the main intersection will need to be stored in this left-turn lane until the lagging protected left-turn phase begins.

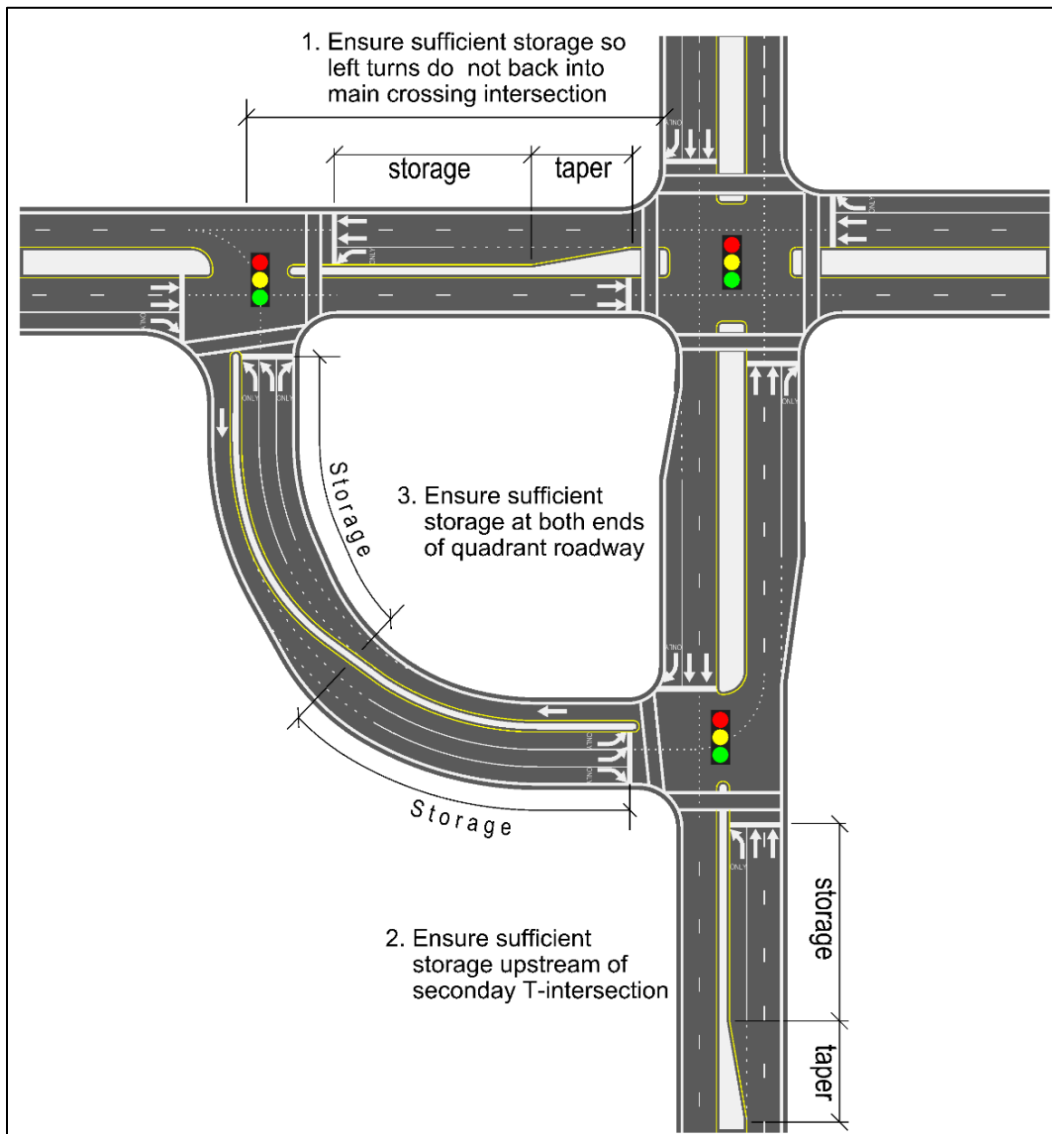

© NCDOT

Figure 57. Graphic. Queue storage areas of concern.

2. Upstream left-turn storage at secondary T-intersection. There is less of a concern about queue spillback into the main intersection on A Street. However, providing adequate left turn storage at this upstream secondary T-intersection must consider impacts to driveways and intersections downstream from this intersection.

3. Queue storage on the quadrant roadway. This distance should be analyzed to determine sufficient storage based on the exiting quadrant roadway volumes (at both ends), the length of the quadrant roadway, the number of lanes and left-turn storage provided on the quadrant roadway, and the assumed cycle length. Shorter quadrant roadways (less than 800 ft) will require greater attention to queue lengths and storage requirements to ensure there is no spillback between the two secondary T-intersections.

Note that queuing between the secondary T-intersection and main intersection is typically not critical because the signal phasing is set to progress and not store queues between the two intersections. This is described in greater detail in chapter 5.

INCIDENT RESPONSE CONSIDERATIONS

Direct left turns at QR intersections are denied by signing, signal indications, and pavement markings. However, emergency vehicles using sirens and flashing lights as they approach a QR intersection can make a direct left turn after vehicles with conflicting movements have yielded the ROW. This practice is no different than an emergency vehicle making a direct left turn at a conventional intersection when approaching a red signal indication. As noted earlier, QR intersections have 20 fewer conflict points at the main intersection compared a conventional intersection. As a result, emergency vehicles traveling through the QR intersection have fewer potential conflict points with vehicles who must yield right of way.

One issue that may arise related to emergency vehicles is whether or not the quadrant roadway should have its own street name and address number. Having a street number is necessary for efficient emergency vehicle response; however, naming the quadrant roadway complicates signing and wayfinding for motorists using the roadway as part of a left-turn movement. The preferred practice is to name the quadrant roadway only if the land parcels are not accessible from either roadway (are ONLY accessible via the quadrant roadway).

OBSERVED SAFETY PERFORMANCE

There is little published crash data and documented safety performance for existing QR intersections. There has also not yet been a noteworthy study of crash experience at QR intersections, and no crash data involving pedestrians or bicyclists at QR intersections have been collected or analyzed. This section presents and discusses limited empirical safety data for QR intersections in the U.S.

Crash Observations

Since the publication of the FHWA QR Intersection Tech Brief in 2010, there have been three QR intersections constructed—Fairfield, Ohio; Huntersville, North Carolina; and Front Royal, Virginia. The Fairfield and Huntersville intersections both opened in 2012; thus, there has been sufficient time to acquire meaningful “after” crash data to perform full before-and-after safety studies. The Fairfield QR intersection is located at the main intersection of SR-4 and SR-4 Bypass, and the quadrant roadway was named “Diversion Road”. The Huntersville QR intersection is located at the main intersection of NC-73 and US-21, and the quadrant roadway repurposed an existing roadway (Holly Point Drive) in the southeast intersection quadrant.

At both the Fairfield and Huntersville QR intersections, before-and-after safety studies have been conducted by their governing transportation agencies that include three years of crash data collected from before and after the QR intersection was opened. However, this is a naïve analysis that does not account for effects of changing traffic volume or non-site specific trends that may influence crashes in the respective communities.

Table 6 summarizes the results of the before-and-after safety study conducted for the Fairfield QR intersection.⁽²²⁾ Comparative analysis results show that crashes at the main intersection and the SR-4 / Diversion Road T-intersection were reduced in number and severity compared to the prior conventional intersection. However, there were a significant number of crashes, many resulting in injuries, at the SR-4 Bypass / Diversion Road intersection, bringing the three-intersection total to be greater than the “before” singular conventional intersection. Further evaluation of the crash data showed the clear majority of the SR-4 Bypass / Diversion Road crashes were rear-end crashes (72 percent), and further engineering studies are on-going to determine if signal timing, driver confusion or other causes are the root of the high crash frequency at this T-intersection.

Table 6. Three-year crash data comparison at Fairfield QR intersection.

Crash Type	Pre-Project SR-4 / SR-4 Bypass	Post-Project SR-4 / SR-4 Bypass	Post-Project SR-4 / Diversion Rd	Post-Project SR-4 Bypass / Diversion Rd	Post-Project Totals (3 Intersections)	Post-Project Total Change
Total Crashes	77	55	10	90	155	+102%
Injury Crash	30	15	2	23	40	+33%
Injuries	45	19	3	37	59	+31%
Fatal	0	0	0	0	0	no change
Serious Injury	2	0	1	1	2	no change

Note: Pre-project data collected Nov 2006 to Nov 2009; Post-project data collected for 3-year period from August 2007 to July 2010.

Table 7 summarizes the results of the before-and-after safety study conducted for the Huntersville QR intersection.⁽²³⁾ Comparative analysis results show that total crashes and frontal impact (higher severity) crashes were increased at two of the three intersections, with reductions only at the NC-73 / Holly Point intersection. However, the total crash severity index increased by only 1 percent (from 3.09 to 3.12). Also, the average intersection volume increased by 10,000 vpd (an 18 percent increase) in the years between the before-and-after crash study periods. Factoring the crashes per million-vehicles entering the intersection, the crash rates before was 2.24 per million vehicles and after was 2.44 per million vehicles (a 9-percent increase).

Table 7. Three-year crash data comparison at Huntersville QR intersection.

Crash Types	Before NC-73 / US-21	Before NC-73 / Holly Pt.	Before US-21 / Holly Pt.	Totals	After NC-73 / US-21	After NC-73 / Holly Pt.	After US-21 / Holly Pt.	Totals	Total Change
Total Crashes	65	35	13	203	81	28	36	265	+31%
Severity Index	-	-	-	3.09	-	-	-	3.12	+1%
Fatal/Class A Injury Crashes	-	-	-	1	-	-	-	0	-100%
Front Impact Crashes	10	23	9	42	22	5	21	48	+14%
Rear End Crashes	47	11	4	62	47	17	11	65	+5%

Note: Pre-project data collected Nov 2006 to Nov 2009; post-project data collected July 2012 to July 2015. – Signifies no data available.

Table 8 summarizes the results of the before-and-after safety study conducted for the Front Royal intersection.⁽²⁴⁾ The crash study area included the same roadway segment lengths upstream and downstream from the main intersection, with and without the additional QR T-intersections. Note that since the Front Royal QR intersection has been open for only 18 months, only one year of crash data was available to be compared to three years of the conventional intersection prior to the QR intersection project. Therefore, results from this study should be regarded with caution.

Comparative analysis results show that total crashes increased by 25 percent, but injury crashes and injuries were reduced by 130 and 230 percent, respectively. Property-damage-only (PDO) crashes and costs increased by 48 and 23 percent, respectively.

Table 8. One-year crash data comparison at Front Royal QR intersection.

Crash Types	2011 Crash Data	2012 Crash Data	2013 Crash Data	3-Year Total	2011-2013 Avg	2018 Crash Data	Percent Change
Total Crashes	5	7	6	18	6.0	8	+25%
Rear End Crashes	5	7	6	18	6.0	5	-20%
Angle Crashes	0	0	0	0	0.0	1	+100%
Sideswipe (same direction)	0	0	0	0	0.0	2	+200%
Injury Crashes	3	2	2	7	2.3	1	-130%
Persons Injured	5	2	3	10	3.3	1	-230%
PDO Crashes	2	5	4	11	3.7	7	+48%
PDO Costs	\$31,300	\$24,800	\$21,000	\$77,200	\$25,733	\$33,400	+23%

Note: Three-year pre-project data collected Jan 2011 to Dec 2013; One-year post-project data collected Jan to Dec 2018.

SUMMARY OF SAFETY EVALUATION CONSIDERATIONS

Due to the limited number of QR intersections that have been open for a sufficient time to gather meaningful post-installation crash data, there are not yet CMFs specific to QR intersections. If agencies wish to construct their own before-and-after safety evaluation of a set of QR intersection projects, there are several factors to keep in mind, including:

- The boundaries of the analysis area need to be large enough to include all three QR intersections. It would be unfair to compare a conventional intersection to just the main intersection of a QR intersection.
- Left-turn vehicles at a QR intersection drive longer distances to negotiate the quadrant roadway compared to conventional intersections. Thus, any analyses using rates, such as crashes per vehicle-mile, must consider the “extra” distances driven.
- It is possible that some left-turning drivers may alter their routes to avoid the intersection or use patterns outside of the QR, if available, or through vehicles may divert to the uncongested quadrant roadway. Thus, crash migration should be given due consideration. Analysts should measure traffic demands during the before and after periods, and if crash migration is suspected should also widen the scope of analysis to include new routes drivers are using.
- QR intersections may be installed in conjunction with developments that generate traffic. This reinforces the need to account for volume in an analysis since higher volumes result in more predicted crashes and lower crash rates for the same number of crashes. Methods such as empirical Bayes analysis, described in the *Highway Safety Manual*,⁽¹²⁾ are able to explicitly handle changes in traffic volumes.

General guidance on before-and-after safety studies and development of CMFs can be found in FHWA’s *A Guide to Developing Quality Crash Modification Factors*.⁽²⁵⁾

CHAPTER 5 — OPERATIONAL CHARACTERISTICS

This chapter provides information on the unique operational characteristics of QR intersections and how they affect elements such as traffic signal phasing and coordination. The guidance presented here builds on existing QR intersection studies, which include operational performance studies, comparative performance studies, and simulation analysis. The chapter also provides guidance relating to design elements that could affect the operational performance of QR intersections. It is intended to help transportation professionals understand the unique operational characteristics of QR intersections and prepare them for conducting operational analysis as described in chapter 6.

Figure 58 compares D Street left-turn movements made at a conventional intersection versus a QR intersection. Figure 59 compares A Street left-turn movements made at a conventional intersection versus a QR intersection.

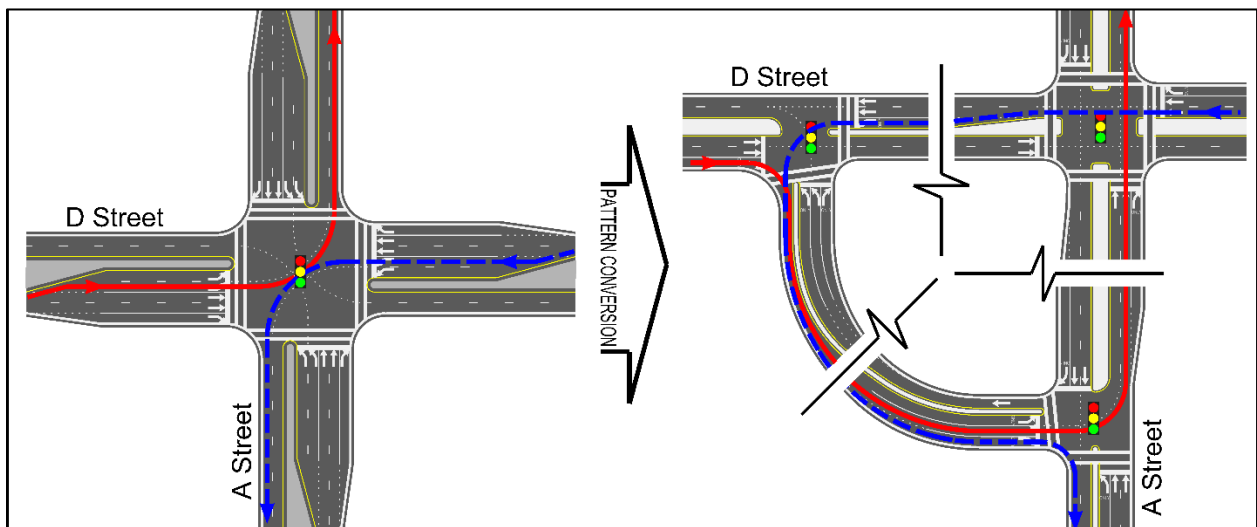

© NCDOT

Figure 58. Graphic. Conventional versus QR left turn movements: D Street.

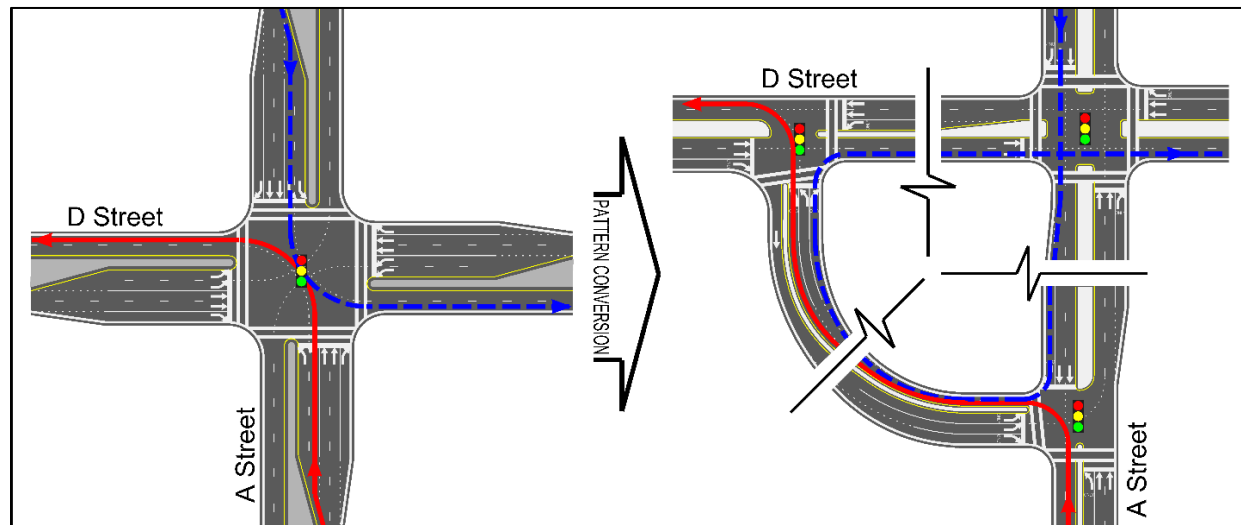

© NCDOT

Figure 59. Graphic. Conventional versus QR left turn: A Street.

OPERATIONAL CONSIDERATIONS

The QR intersection provides traffic operational benefits, particularly for through movements, by reducing the number of intersection signal phases at the main intersection and shortening intersection signal cycle lengths. Despite several turning patterns requiring vehicles to travel an additional distance compared to a conventional intersection, QR intersection left turns typically have equal or improved travel times. However, there are many operational considerations that can diminish or enhance QR intersection operational performances.

Location of the Quadrant Roadway Based on Volume Characteristics

Each of the four QR intersection left-turn movements illustrated in figure 58 and figure 59 can have significantly different impacts on operations depending on intersection volumes. Using the movement abbreviations developed in chapter 4, some interesting operational characteristics can be noted:

- The QL-QL movement is completely removed from impacting the main intersection. Therefore, the best quadrant arrangement from a capacity and operations perspective would link this movement with the highest intersection left-turn demand. Note that the complementary right turn may also be heavy and would likewise completely avoid the main intersection.
- Movements that end with MT re-route vehicles into an “interior” approach to the main intersection, potentially creating queuing challenges for signal coordination.
- The MT-QR-QR-MT movement potentially impacts the capacity of the main intersection twice (depending on critical movements).

Location of the Quadrant Roadway Based on Land Use and Access Impacts

When planning a QR intersection to improve operations at a conventional intersection, one of the first considerations is in which intersection quadrant to place the quadrant roadway. In most cases, this decision is limited to (or dictated by) the availability of land in a singular intersection quadrant or the presence of an existing roadway that can be repurposed. Since QR intersections are best suited at the crossing of two major roadways, typically one or more (and often all) of the intersection quadrants are often already developed, often limiting the choice of a vacant parcel (if any) and most intersections lack an existing roadway that can be suitably repurposed as a quadrant roadway.

In the case that there is land available in two or more quadrants, future operations can be modeled for each option available using planning-level tools (such as FHWA’s Capacity Analysis for Planning of Junctions [CAP-X] tool) to gain a general understanding of intersection capacity, geometric requirements and expected intersection operations. However, because of the interdependency of the three traffic signals in a QR intersection, detailed operational analysis requires the use of microscopic simulation tools to answer detailed questions such as total travel time of individual left-turn patterns before and after a QR intersection improvement.

The QR intersection has varying access impacts in each of the four intersection quadrants, as illustrated in figure 60. The intersection quadrant containing the quadrant roadway has potentially the best access, as property (or properties) on the outside of the quadrant roadway could have access to both intersecting roadways via the quadrant roadway and the area inscribed by the quadrant roadway has access to both signalized intersections (via the quadrant roadway) plus potential RIRO access to both roadways.

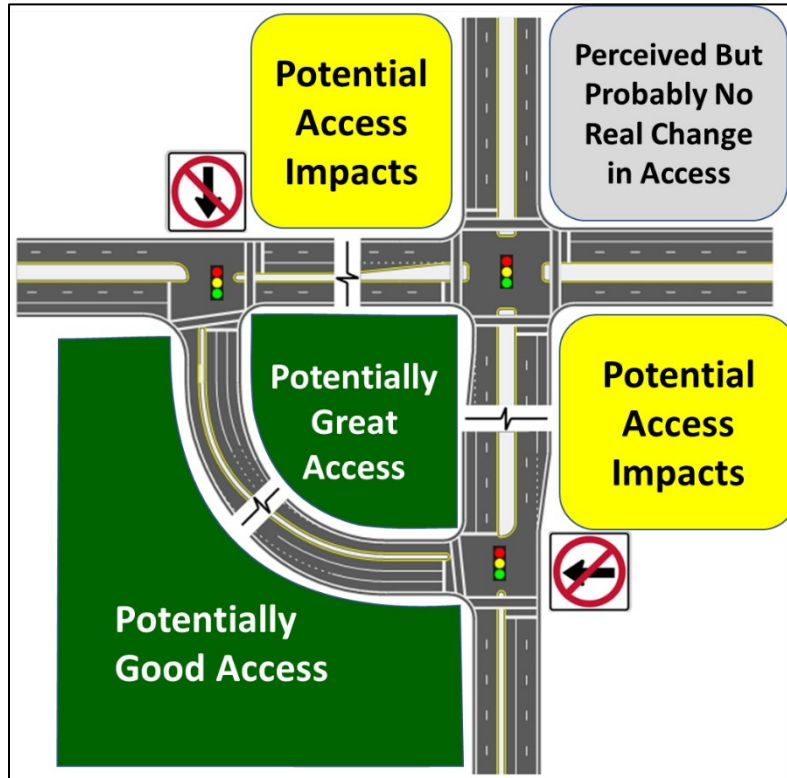

© NCDOT

Figure 60. Graphic. QR intersection access impacts.

The two quadrants opposite the quadrant roadway have potential access impacts. While landowners and developers would see immediate potential for access to either intersection roadway (by adding a driveway as a fourth leg to the T-intersection signal), the overall efficiency of the QR intersection depends on the signal phasing afforded by the T-intersection. Therefore, **every effort should be made to preserve the T-intersection functionality and limit access between signalized intersections to right-in/right-out access.** Lastly, the intersection quadrant diagonally opposite from the quadrant roadway may have *perceived* access impacts due to the loss of direct left turns at the main intersection, but efficiency gains by the QR intersection should offset any perceived impacts to access to this quadrant.

Access Management

Access management is an important factor to consider in QR intersection safety. QR intersections are best suited for urban and suburban areas where there is often auto-dependent development in one or more intersection quadrant(s) that depend on good access to both intersecting roadways.

Potential access management issues that could impact intersection operations and safety include:

- Allowing a fourth leg at one or both secondary T-intersections with managed access. The Huntersville, North Carolina partial-QR intersection allows a fourth leg at the NC-73 / quadrant roadway intersection to provide access to a regional shopping center opposite the quadrant roadway. Access to the fourth leg is managed by a RCUT intersection design that permits left turns from NC-73 but restricts left turns from the fourth leg, lessening intersection operational and safety impacts of a full-movement intersection.
- Relocating an existing roadway that would otherwise add an additional leg to the secondary T-intersection (or worse, intersect the roadway in between the main and secondary T-intersections). The Front Royal, Virginia QR intersection included the relocation of an existing residential street to intersect one of the roadways at a full-movement intersection upstream of the secondary-T intersection.

While access management needs and issues will be different for each site, there are several principles that will help the QR intersection function optimally:

- At a minimum, a raised median should be placed between the crossing and secondary T-intersections on BOTH roadways. This access control will limit delays and unexpected vehicle conflicts between the closely spaced intersections. Right-in/right-out access may be provided between these intersections so long as the impacts do not degrade traffic on the through roadways.
- A raised median is highly recommended along the length of the quadrant roadway between secondary T-intersection to limit future full access to the quadrant roadway. If access to the quadrant roadway is required to serve existing development and can be safely managed, a singular mid-point access may be provided and ideally managed with a directional median opening. If there are multiple land uses within the quadrant roadway, the driveways should be consolidated to a single access point on the quadrant roadway.
- With both of the first two access management principles in place, the land parcel inscribed by the quadrant roadway is limited to right-in/right out access on one or more roadways, and this may present challenges to access depending on the land use within the quadrant. Allowing U-turns on any of the intersection approaches should be avoided, particularly where no dedicated left / U-turn lane is provided.

Figure 61 illustrates access management principles where land uses within the quadrant can be served by a RIRO access on the quadrant roadway. Figure 62 illustrates access management principles where directional median access to the area inscribed by the QR is provided from the quadrant roadway.

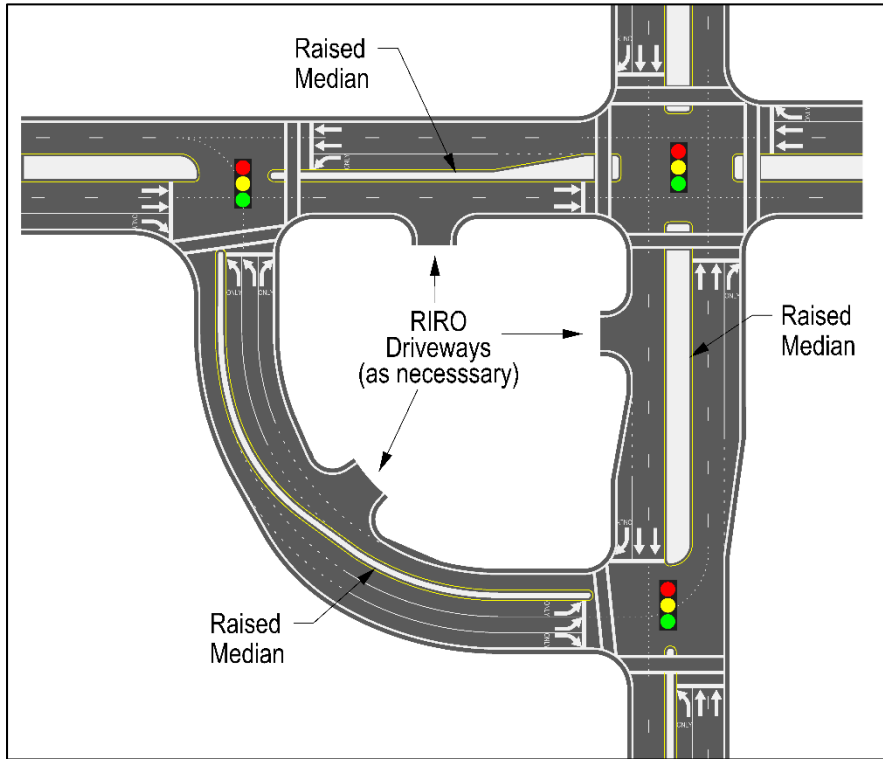

© NCDOT

Figure 61. Graphic. QR RIRO access management recommendations.

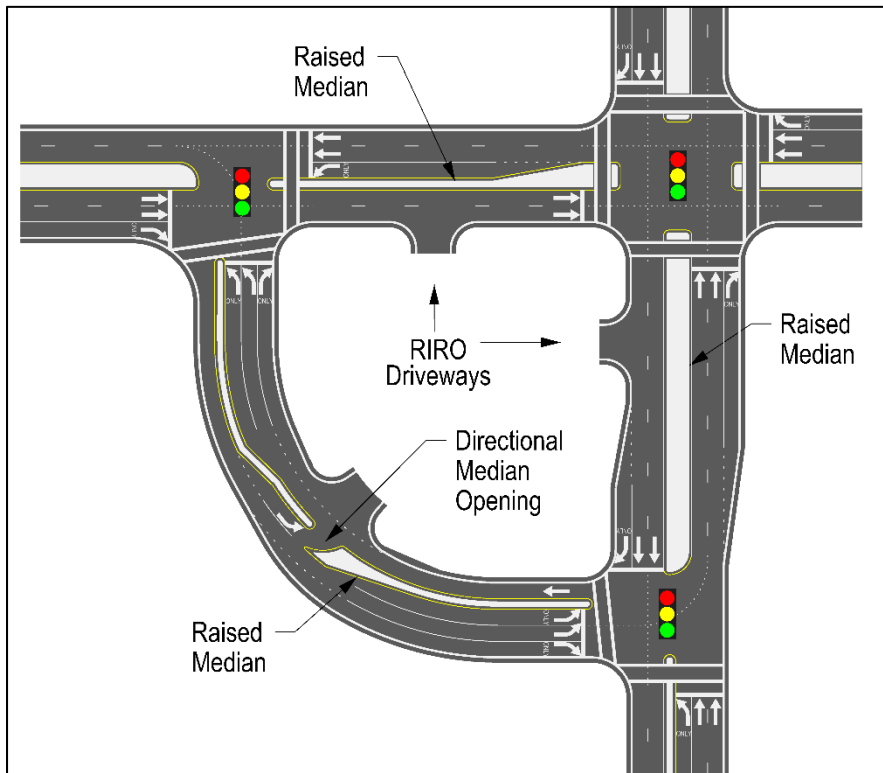

© NCDOT

Figure 62. Graphic. QR directional access management recommendations.

The level of access management on the quadrant roadway has impacts on the accessibility to land uses within the quadrant roadway. Figure 63 and figure 64 illustrate vehicle paths approaching the QR intersection from all four directions and shows the paths of both pass-by traffic and traffic destined for land uses internal to the quadrant roadway and then returning to their ordinal direction. Figure 63 shows vehicle paths assuming RIRO access to the quadrant and figure 64 shows vehicle paths assuming a directional median break on the quadrant roadway. The RIRO access condition requires provision of three different U-turn movements and creates a circuitous return path for vehicles to/from the north (under this quadrant roadway location). Providing a directional median opening on the quadrant roadway eliminates one U-turn movement at the secondary T-intersection. Note that the routing patterns assume that there is internal circulation within the inscribed intersection quadrant that connects the access points.

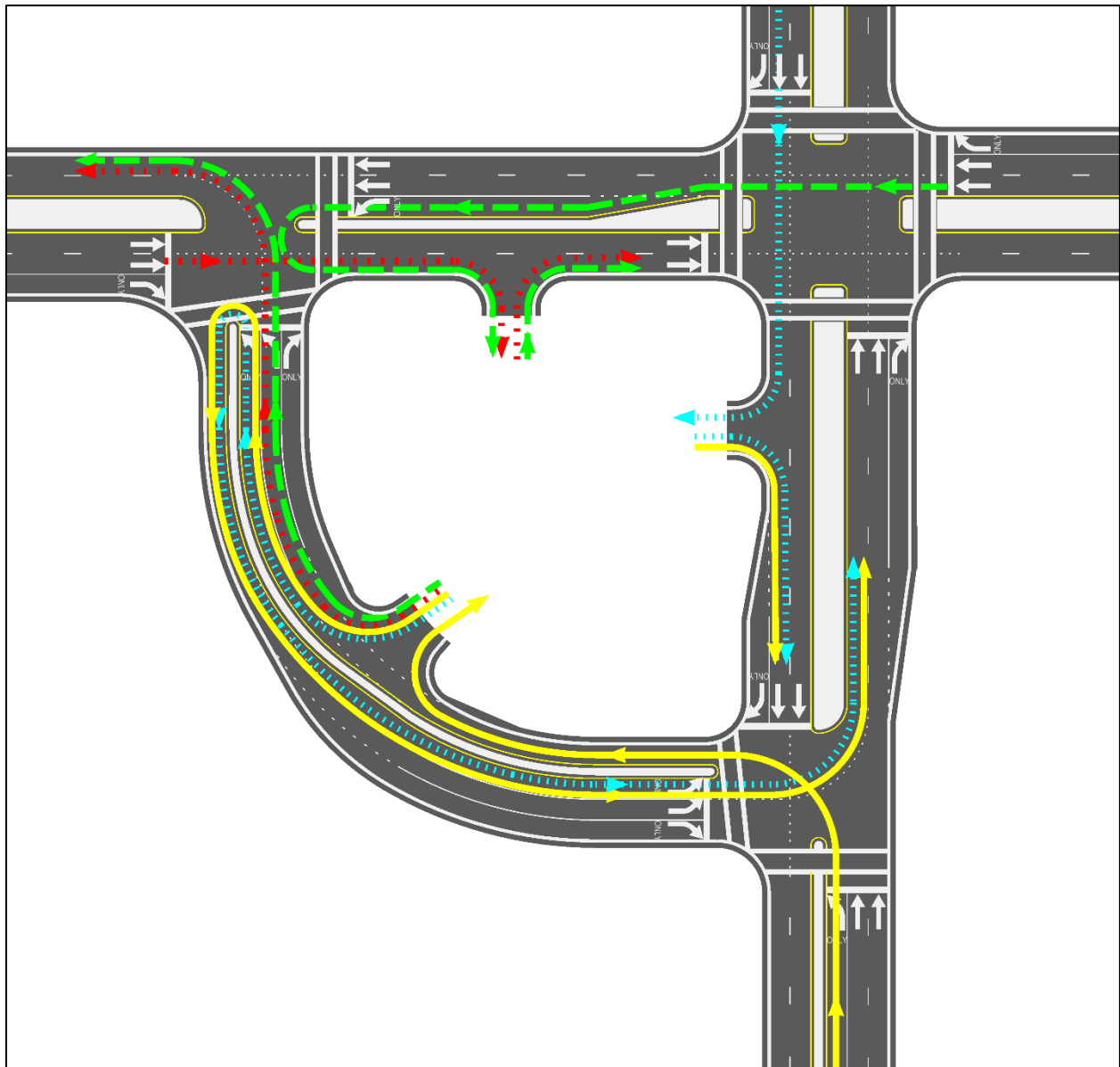

© NCDOT

Figure 63. Graphic. Directional vehicle paths w/RIRO access on quadrant roadway.

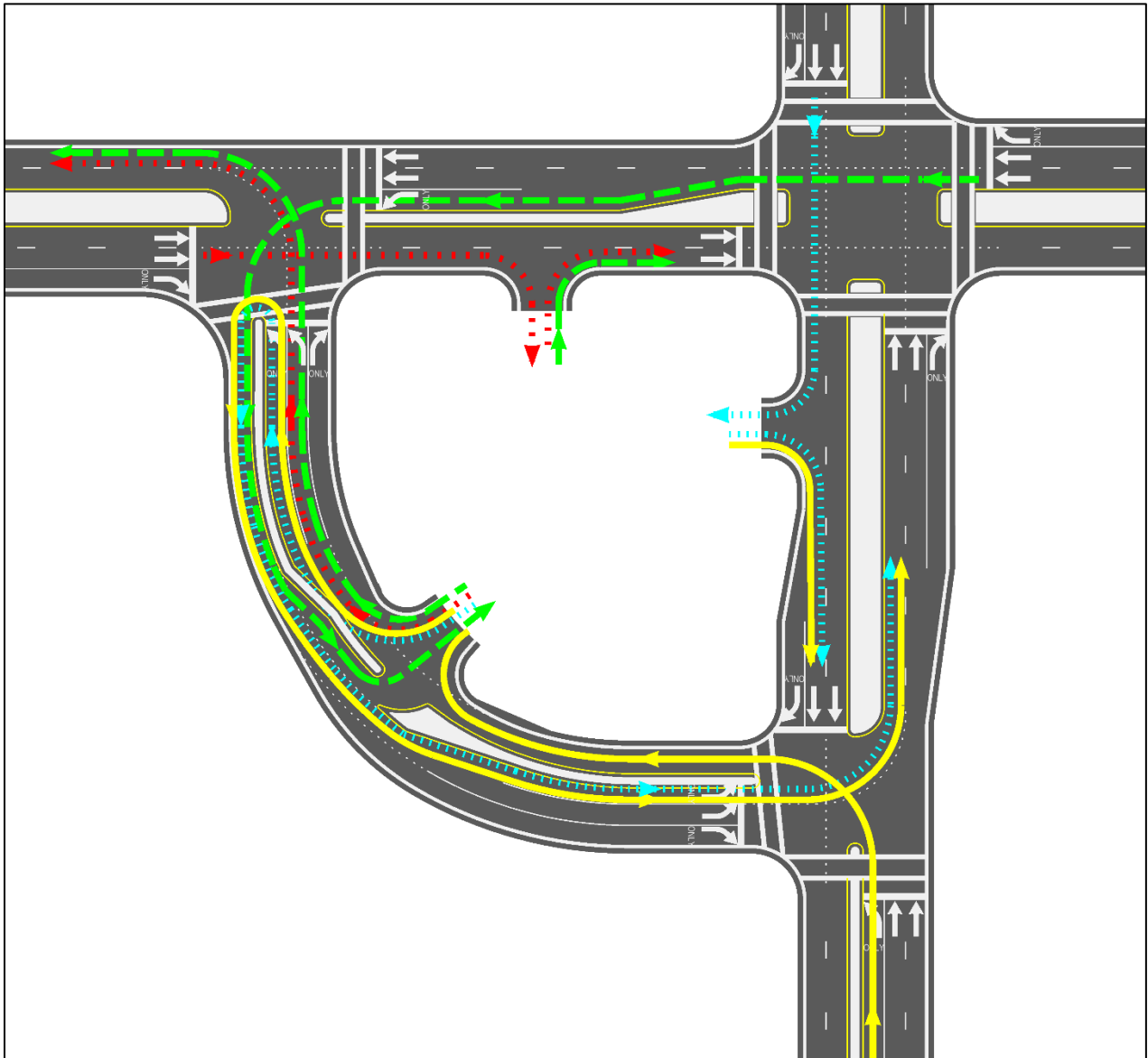

© NCDOT

Figure 64. Graphic. Directional vehicle paths w/directional access on quadrant roadway.

Spacing of Secondary T-Intersections

The spacing of the two secondary T-intersections have significant impact on both intersection operations and motorist acceptance of the QR intersection. Secondary T-intersections placed too close to the main intersection may cause a queue spillback from the left-turn lane onto the quadrant roadway. Secondary T-intersections placed too far from the main intersection increases the added distance left turns must travel, which may be untenable to motorists and cause them to seek other paths via parallel roads and/or through surface parking to cut through and bypass the main intersection. Note that QR intersection geometry does not have to be symmetrical; the crossing and two secondary T-intersections may have unequal spacing.

As noted in chapter 4, crossing and secondary T-intersections spaced too close together may create safety and operational issues. Of equal concern is crossing and secondary T-intersection spacing that is too far apart. For most QR intersection left-turn movements, motorists are

traveling greater distances to make a left-turn compared to a conventional intersection. Figure 65 illustrates the additional travel distance incurred by left-turn movements at QR intersections assuming equal 500-ft intersection spacing. Two left-turn movements incur an additional 850 ft in travel distance, with the longest left turn path (A to D) requiring an additional 1,850 ft travel distance. Figure 66 illustrates the additional travel distance incurred by left turn movements at QR intersections assuming equal 800-ft intersection spacing. At this spacing, two left-turn movements incur an additional 1,320 ft in travel distance, with the longest left turn path (A to D) requiring an additional 2,920 ft travel distance (more than 0.5 mi). At an average travel speed of 30 mph, the 2,920 ft travel distance equates to 70 seconds of travel time, which may exceed delays waiting for a left-turn phase at a conventional signalized intersection.

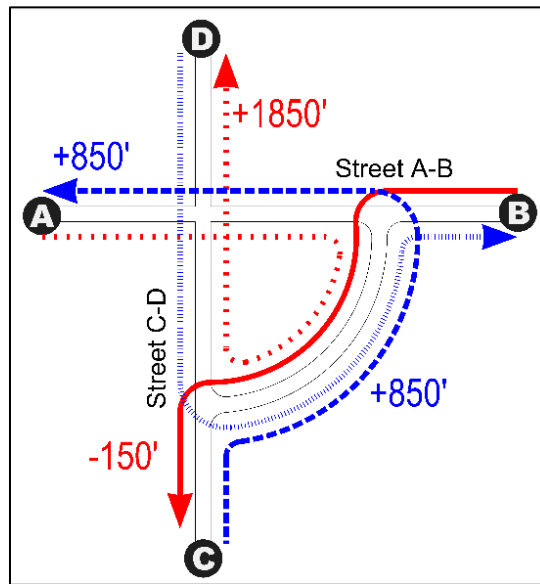

© NCDOT

Figure 65. Graphic. Additional QR left-turn travel distances at 500-ft spacing.

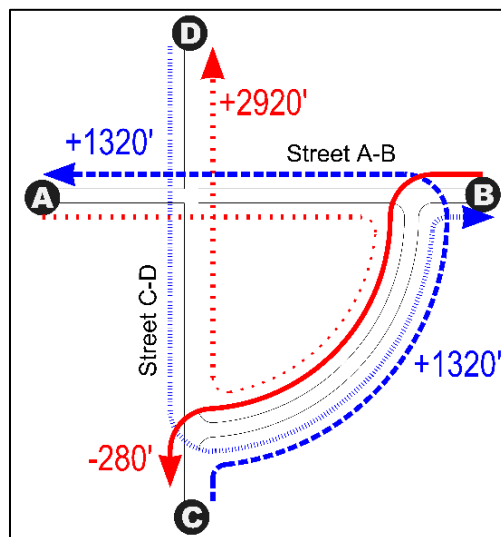

© NCDOT

Figure 66. Graphic. Additional QR left-turn travel distances at 800-ft spacing.

Table 9 through table 13 provide the travel distances for QR roadway left turns compared to left turns at a conventional intersection based on different intersection spacings on Street A-B and Street C-D, assuming the quadrant roadway is located in intersection quadrant B-C.

Table 9. Additional QR left-turn travel distances: Street C-D spacing = 400 ft.

Left Turn	Street A-B Spacing 400 ft	Street A-B Spacing 500 ft	Street A-B Spacing 600 ft	Street A-B Spacing 700 ft	Street A-B Spacing 800 ft
A to D	1,490	1,690	1,890	2,090	2,290
B to C	-110	-110	-110	-110	-110
C to A	690	690	690	690	690
D to B	690	890	1,090	1,290	1,490
<i>Totals</i>	<i>2,760</i>	<i>3,160</i>	<i>3,560</i>	<i>3,960</i>	<i>4,360</i>

Table 10. Additional QR left-turn travel distances: Street C-D spacing = 500 ft.

Left Turn	Street A-B Spacing 400 ft	Street A-B Spacing 500 ft	Street A-B Spacing 600 ft	Street A-B Spacing 700 ft	Street A-B Spacing 800 ft
A to D	1,690	1,850	2,050	2,250	2,450
B to C	-110	-150	-150	-150	-150
C to A	890	850	850	850	850
D to B	690	850	1,050	1,250	1,450
<i>Totals</i>	<i>3,160</i>	<i>3,400</i>	<i>3,800</i>	<i>4,200</i>	<i>4,600</i>

Table 11. Additional QR left-turn travel distances: Street C-D spacing = 600 ft.

Left Turn	Street A-B Spacing 400 ft	Street A-B Spacing 500 ft	Street A-B Spacing 600 ft	Street A-B Spacing 700 ft	Street A-B Spacing 800 ft
A to D	1,890	2,050	2,210	2,410	2,610
B to C	-110	-150	-190	-190	-190
C to A	1,090	1,050	1,010	1,010	1,010
D to B	690	850	1,010	1,210	1,410
<i>Totals</i>	<i>3,560</i>	<i>3,800</i>	<i>4,040</i>	<i>4,440</i>	<i>4,840</i>

Table 12. Additional QR left-turn travel distances: Street C-D spacing = 700 ft.

Left Turn	Street A-B Spacing 400 ft	Street A-B Spacing 500 ft	Street A-B Spacing 600 ft	Street A-B Spacing 700 ft	Street A-B Spacing 800 ft
A to D	2,090	2,250	2,410	2,560	2,760
B to C	-110	-150	-190	-240	-240
C to A	1,290	1,250	1,210	1,160	1,160
D to B	690	850	1,010	1,160	1,360
<i>Totals</i>	<i>3,960</i>	<i>4,200</i>	<i>4,440</i>	<i>4,640</i>	<i>5,040</i>

Table 13. Additional QR left-turn travel distances: Street C-D spacing = 800 ft.

Left Turn	Street A-B Spacing 400 ft	Street A-B Spacing 500 ft	Street A-B Spacing 600 ft	Street A-B Spacing 700 ft	Street A-B Spacing 800 ft
A to D	2,290	2,450	2,610	2,760	2,920
B to C	-110	-150	-190	-240	-280
C to A	1,490	1,450	1,410	1,360	1,320
D to B	690	850	1,010	1,160	1,320
<i>Totals</i>	<i>4,360</i>	<i>4,600</i>	<i>4,840</i>	<i>5,040</i>	<i>5,280</i>

While there is no hard rule for maximum intersection spacing, planners and designers should be acutely aware of the left-turn distance and travel time penalties imposed by greater intersection spacing, particularly when other travel path alternatives exist (even circuitous cut-through or paths through parking lots) that may tempt motorists to avoid using the prescribed QR intersection turning paths.

Left-Turn Storage

Minimum intersection spacing can also be governed by the needed distance for left-turn storage between the main intersection and downstream secondary T-intersection. The length of left-turn storage bays should be determined thorough HCM analyses or microsimulation study, but as a rule of thumb, the left-turn storage lane should be designed to accommodate 1.5 to 2 times the average vehicle queues per cycle. AASHTO guidance calls for a taper rate of between 8:1 to 15:1 for high-speed roadways. Table 14 summarizes a suggested minimum distance (to accommodate adequate storage plus taper) between the crossing and secondary T-intersections based on levels of left-turn volumes and 90- and 120-second cycle lengths.

Table 14. Storage bay and taper length guidance.

Left Turns (vph)	Storage + taper length (90-second cycle)	Storage + taper length (120-second cycle)
100	190 - 230	230 - 270
150	240 - 290	290 - 350
200	290 - 350	350 - 430
250	330 - 410	410 - 520
300	380 - 480	480 - 600
350	430 - 540	540 - 680
400	480 - 600	600 - 770

Note: Assumes single turn lane, average car length of 25 ft and minimum taper ratio of 8:1 (100 ft for 12-ft lanes).

Table 14 values support an assumption that intersection spacing of approximately 500 ft should provide adequate intersection storage, with greater storage needed in cases of high left-turn volumes (more than 300 vph) and/or moderate left-turn volumes and longer cycle lengths (120 seconds and greater). Note that these values are provided to serve as a planning-level guide for minimum intersection spacing. Governing State or jurisdictional policies for storage length and/or taper lengths should be investigated and followed.

Simulation studies have shown that at intersections with moderate to low left-turn demand (300 vph or less) and a cycle length of 120 seconds or less, a left-turn bay and taper of 300 and 150 ft, respectively (resulting in an overall intersection spacing of approximately 500 ft), will provide adequate queue storage at a 95-percent confidence level.⁽¹⁾ However, it is always appropriate to use HCM and/or microsimulation analysis to verify storage lengths required with known intersection volumes and signal timings.

Coordination with Mobile Navigation Systems

During the final stages of the project, the project team or jurisdictional authority should consider contacting the large providers of mobile navigation data to ensure that the coding of the QR intersection (including turn prohibitions) is current when the project opens in order to avoid

confusion or incorrect movements. In the case of the SR-4 / SR-4 Bypass, the right-turning movement was not coded correctly, and instead of a simple right-turn movement at the main intersection, motorist on northbound SR-4 were directed to travel through the main intersection, turn right onto the quadrant roadway and then left at the secondary T-intersection. Once this was conveyed to the project manager, a request was made to fix the coding of this intersection.

SIGNAL CYCLE LENGTHS, PHASING AND COORDINATION

Cycle Length

The QR intersection, like many other alternative intersections, removes left-turn phasing at the main intersection, which results in a reduction in the number of clearance phases in each signal cycle from four to two compared to a conventional intersection. The time formerly allocated for the eliminated clearance intervals can be reallocated to through and right-turn movements at the main intersection that results in greater intersection efficiency. The elimination of clearance phases and reduction in signal phases can also allow the cycle length to be shortened, as only two phases and two clearance times are served in the signal cycle. The left-turn clearance phases are typically longer than through movement clearance times and are removed from the signal cycle. Shorter cycle lengths allow more cycles to be served each hour, and vehicles have less time to “store” and form queues, thus shortening queues. However, desirable short cycle lengths are often infeasible for conventional intersections with multi-phase signals required to serve all approach demands.

Figure 67 illustrates a 150-second conventional intersection multi-phase signal that serves protected through and separate left-turn movements from both intersecting roadways, separated by intersection clearance phases. Figure 68 illustrates a 90-second QR main intersection two-phase signal that serves through and right-turn movements from both intersecting roadways, separated by intersection clearance phases. Figure 69 illustrates a 90-second QR secondary T-intersection that serves the through street and turns to/from the quadrant roadway. Under the QR intersection, the percentage of the signal cycle allocated to through and right-turn movements is significantly increased by the elimination of left-turn and clearance phases and more cycles can be served each hour.

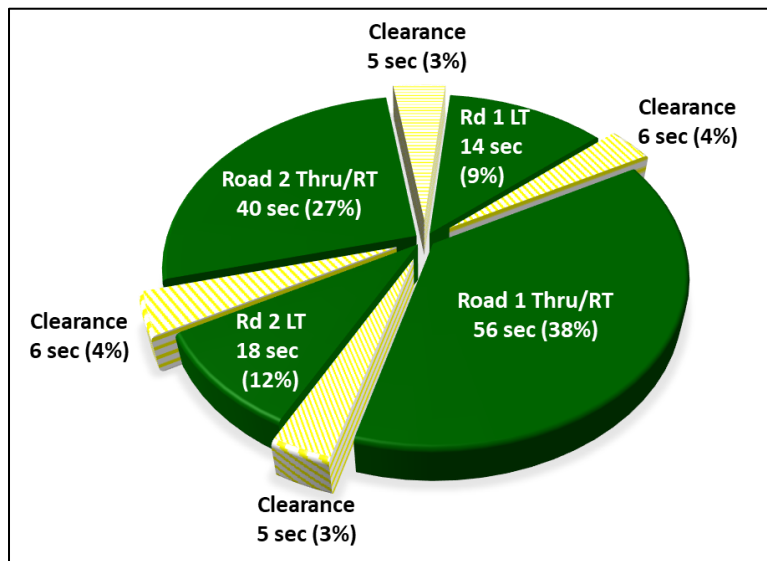

© NCDOT

Figure 67. Graphic. 150-second conventional intersection multi-phase signal splits.

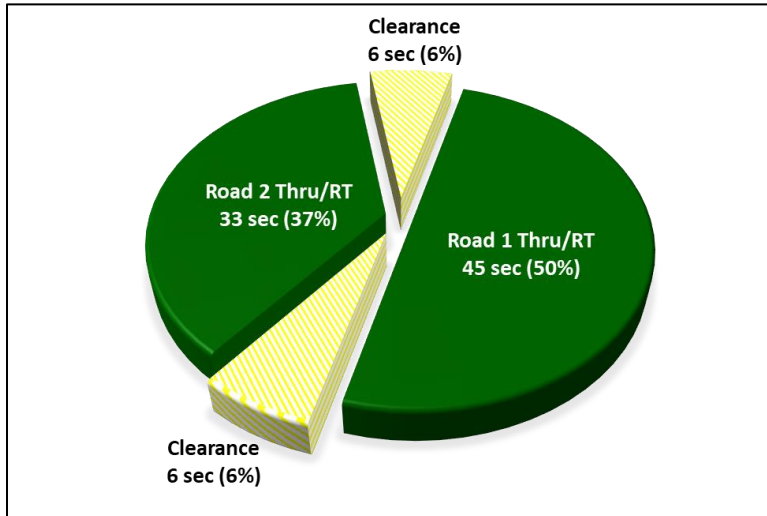

© NCDOT.

Figure 68. Graphic. 90-second QR main intersection signal splits.

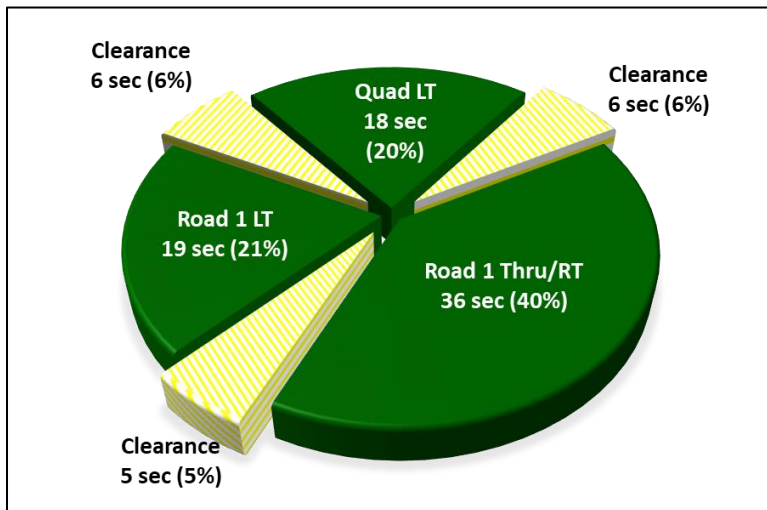

© NCDOT.

Figure 69. Graphic. 90-second QR secondary-T intersection signal splits.

Comparing these figures, the green time allotted to the arterial through movement is 56 seconds under a conventional intersection and 45 seconds under a QR intersection. The conventional intersection 150-second cycle serves 24 full cycles each hour, which allocates 1,344 seconds of green time to the arterial through movement. The QR intersection’s 90-second cycle serves 40 full cycles each hour, which allocates 1,800 seconds of green time to the arterial through movement. Figure 70 illustrates this comparative 34-percent increase in green time provided under the 90-second two-phase signal at a QR intersection compared to the 150-second multi-phase signal at a conventional intersection. However, since left-turn movements pass through the intersection as well (some twice), the actual net increase in capacity is likely to be somewhat less than 34 percent.

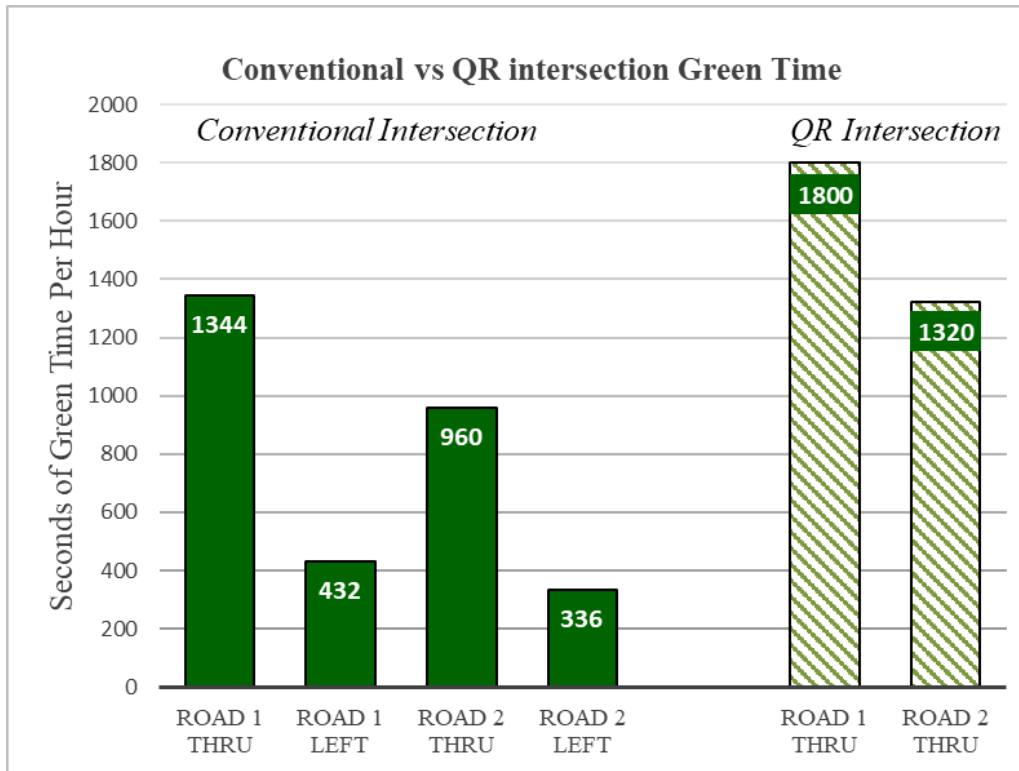

© NCDOT

Figure 70. Chart. Comparison of movement green times.

To achieve optimal QR intersection operations and signal coordination, each of the 3 signalized intersections within the QR intersection must have the same cycle length, which typically ranges from 90 to 120 seconds. The cycle length is dependent on intersection traffic volumes, pedestrian crossing times, and the cycle lengths of other adjacent signals on the corridors upstream and downstream of the QR intersection. In some cases, a QR intersection will operate well with a shorter cycle length than is appropriate for one or more of the other signalized intersections along a corridor. If the cycle length for the QR intersections is half of the cycle length for upstream and downstream signals in the network, signal coordination and progression can remain along the corridor while also maintaining the benefits of QR intersection. In other cases, the cycle length of the corridor signals may be decreased to match the QR intersection cycle length. If the most congested intersection on a corridor is converted to a QR intersection, decreasing the cycle length may benefit intersections for the whole corridor.

Signal Phasing

The QR intersection allows two-phase signal operations at the main intersection, but the secondary T-intersections include three signal phases. Figure 71 illustrates the phasing at the crossing and secondary T-intersections. The main intersection operates under a two-phase signal for both vehicles and pedestrians. This simple signal phasing is both efficient for vehicles and allows sufficient crossing time for pedestrians. The secondary T-intersections require three separate phases to serve the main or crossing street through movements, left turns from the main or crossing street onto the quadrant roadway and left and right turns leaving the quadrant roadway. However, signal phasing and coordination strategies can be employed so that traffic on the main and crossing roadways experience the efficiency of two-phase signal operations.

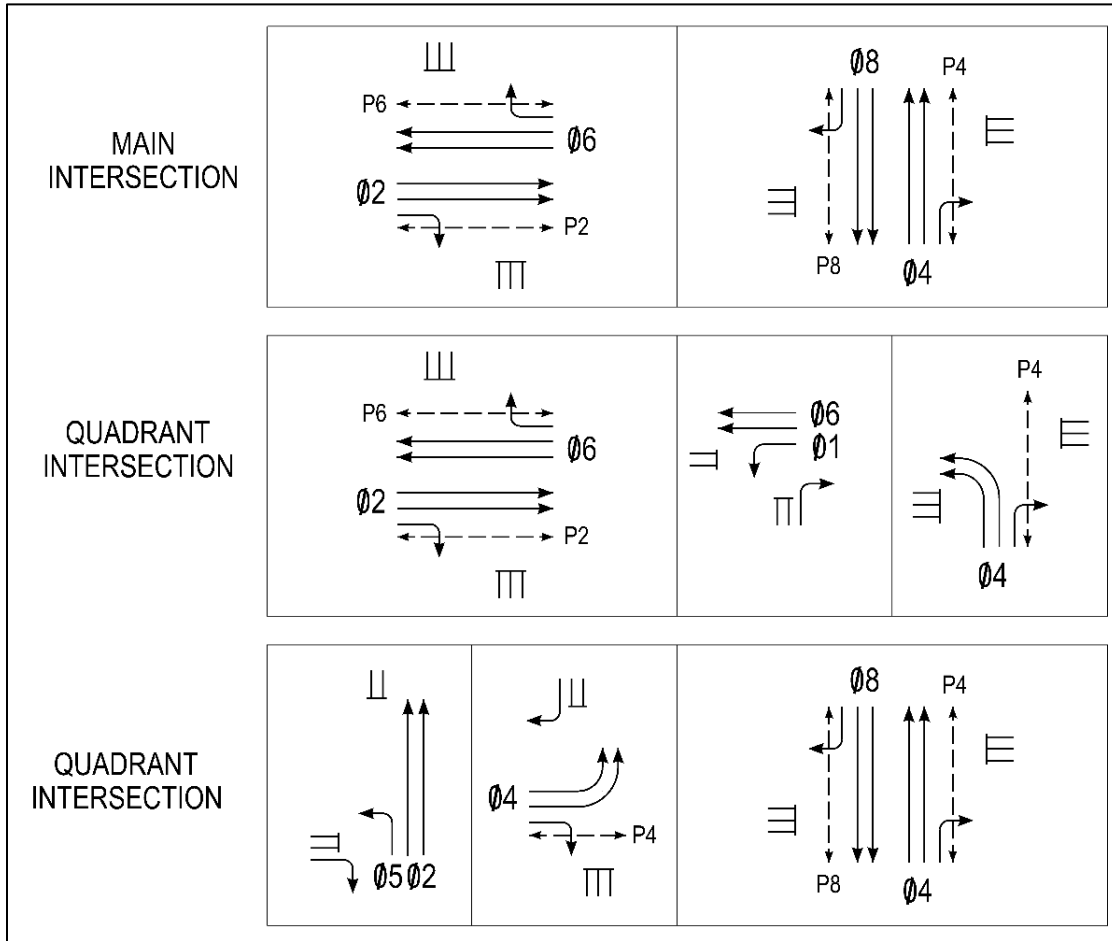

© NCDOT

Figure 71. Graphic. QR intersection signal phasing.

Signal Coordination and Offsets

The removal of left turns at the main intersection results in greater green bandwidths and greater progression opportunities through both the main and secondary T-intersections. If the signal phasing and offsets are properly coordinated, through traffic may be required to stop only at the first signal (either the main or secondary T-intersection depending on approach direction) or travel through BOTH intersections without stopping. As a general rule, through vehicles that stop for the first intersection should always arrive on green at the second intersection; therefore, **all through vehicles should stop no more than once.**

Figure 72 illustrates the spatial time-space diagram (TSD) relationship between the three QR intersection signals. In order for to achieve consistent coordination between the signals, all three intersections must have the same cycle length. In the TSD below, the common cycle length is assumed to be 90 seconds. Equal phase splits were assumed at the two-phase main intersection (40 seconds green plus 5 second yellow/all-red [Y/AR] phase for each direction), and roughly equal left-turn phases were assumed at both secondary T-intersections (22 or 23 seconds green plus 5 seconds Y/AR for each left-turn phase).

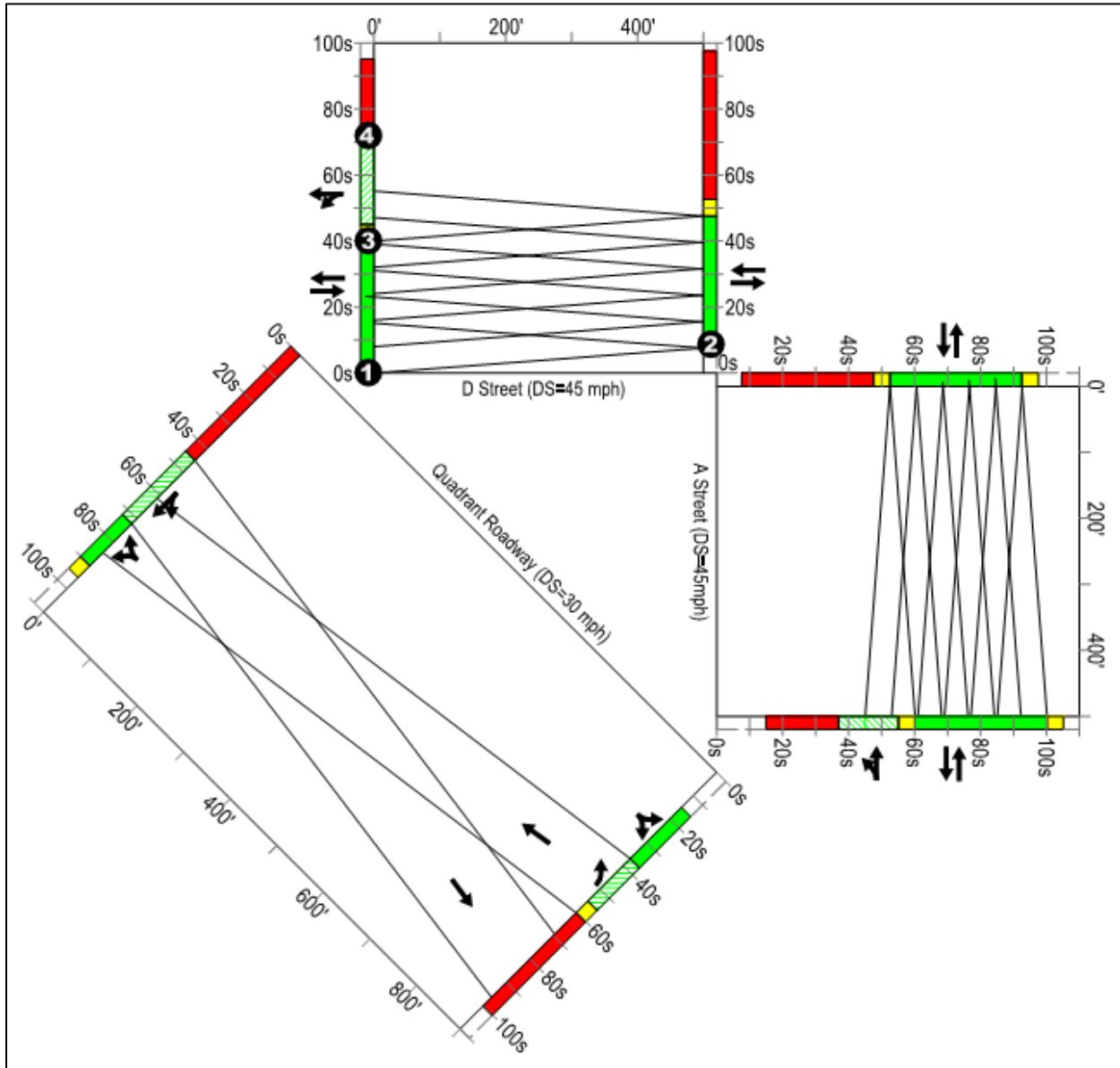

© NCDOT

Figure 72. Graphic. QR intersection time-space diagram.

Beginning with the eastbound through phase at the D Street T-intersection (1), vehicles leave this intersection traveling 500 ft at the 45-mph roadway design speed would arrive approximately 8 seconds later at the main intersection, just as the signal turns green. Conversely, westbound vehicles starting from the main intersection (2) arrive approximately 8 seconds later at the secondary T-intersection while the signal is already green.

When the eastbound secondary T-intersection green phase ends, progression should allow the last eastbound vehicles to proceed through the main intersection. When this phase ends (3), a lagging left-turn phase can begin in the westbound direction, allowing queued left-turning vehicles in the westbound direction to turn left onto the quadrant roadway. This through-left phase lasts as long as needed to clear the left-turn queue, also allowing sufficient time for the last of the westbound through vehicles to clear the secondary T-intersection (4). The remainder of the cycle length at the secondary T-intersection QR can be allotted to serve the left turns departing the quadrant roadway.

Nearly the same cycle pattern repeats itself for A Street; however, the left turn onto the quadrant roadway is a leading left, taking advantage of the delayed arrival of the southbound A Street through vehicles. The leading left begins exclusive and transitions to a shared through-left phase at the time when the through vehicles can progress to arrive at the main intersection at the beginning of green.

Note that the phasing and coordination presented is a simplified condition given that two of the four left-turn movements removed from the main intersection are routed back through the main intersection as part of the through movement. As a result, there may be standing queues on the “internal” main intersection approaches when those approaches receive green. Depending on the level of volumes entering these two approaches while the signal is red, the initial greens could be occupied for several seconds to start-up and clear these waiting queues. The best way to account for the variances in intersection spacing, cycle lengths, design speeds and internal left-turn queuing would be to prepare a site-specific TSD for each unique QR intersection installation, further study coordination and progression using microsimulation tools, and make slight field adjustments according to actual operational conditions when the project opens.

The spatial TSD also shows how two of the left-turn movements arrive at the secondary T-intersections. The travel speeds are adjusted to reflect the lower speed of the quadrant roadway and the longer distance between signals along the quadrant roadway (in this case nearly 900 ft). Figure 72 illustrates that left turns leaving the A Street T-intersection traveling the quadrant roadway counterclockwise would arrive a few seconds before the left-turn phase exiting the quadrant roadway begins. However, left turns leaving the main street secondary T-intersection arrive at the downstream signal squarely within a red phase. Knowing the arrival patterns may be a factor in designing appropriate storage capacity, in this case for right turns onto southbound A Street.

THROUGHPUT AND FLOW RATES

Corridor Throughput

The combination of reduced clearance intervals and reduced cycle lengths with QR intersections enables greater corridor throughput compared to a conventional intersection. However, QR intersections are typically isolated solutions to improve operations at singular intersections with significant volumes on both intersecting roadways. Thus, QR intersections do not necessarily improve *corridor* operations and throughput unless the intersection has the significantly worst operational performance along a corridor.

QR intersections gain throughput efficiency due to the two-phase signal operations at the main intersection. With only two phases, the amount of intersection lost time is reduced due to fewer yellow and all-red clearance phases compared to a conventional intersection. Note that the QR having full signals and spacing is critical to good corridor efficiency.

Lane Utilization

For two approaches to a QR intersection (where left turns are made from the left side of the roadway), lane utilization would be very similar to that of a conventional intersection with the same number and configuration of through and turn lanes. However, the other two approaches, where both left and right turns are made from the right side of the roadway, the rightmost lanes will likely have higher utilization. Consideration should be given to multiple right-turn lanes (or shared through/right-turn lanes) where volumes may overload a single right-turn lane. Also, right-turn storage lanes may have to be lengthened in anticipation of additional vehicle storage. Figure 73 illustrates this proposed geometry.

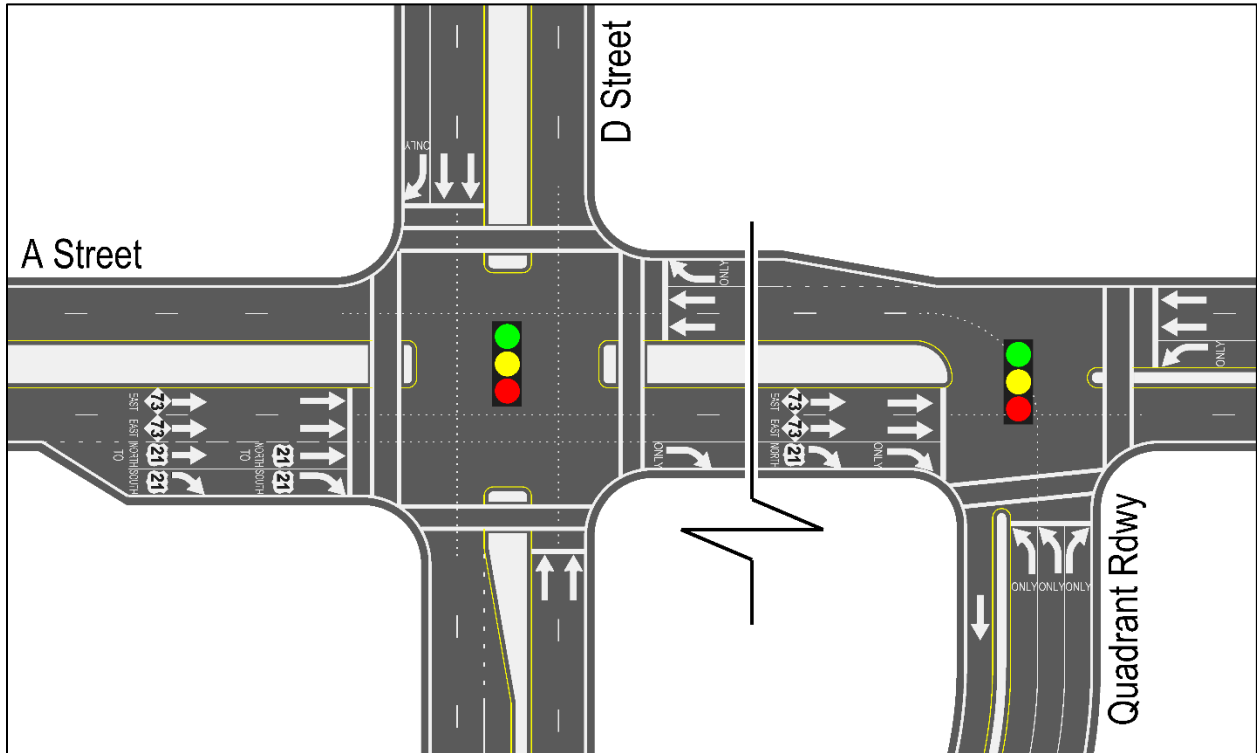

© NCDOT

Figure 73. Graphic. Lane continuity through QR left-turn movement.

Systemwide Considerations

Unlike corridor-based alternative intersection treatments like the RCUT, QR intersections are suitable for and typically used at a singular intersection where volumes on both roadways are significant and fairly balanced; thus, the QR intersection is more likely to compete with multilane roundabouts, displaced left-turn (DLT) intersections, and MUT intersection alternatives. The use of multiple QR intersections in a corridor is not discouraged, but there would likely be little operational gains to the corridor and finding successive intersections with vacant quadrants or viable roadways to repurpose for quadrant roadways may be challenging. All known QR intersections constructed to date have been at isolated intersection locations.

COMPARATIVE PERFORMANCE STUDIES AND LITERATURE REVIEWS

Based on the comparative traffic operations and simulation studies summarized in table 15, QR intersections had the following operational advantages compared to conventional designs:

- Significantly reduced intersection queuing.
- Increased throughput of 5 to 15 percent.
- Reduced intersection delay by 20 to 50 percent.
- Consistently high-performing intersection form under varying geometric and volume conditions.

Table 15. Summary of comparison literature and performance studies.

Study Authors, Publication & Date	Type of Study	Key Finding
Reid, ITE Journal 2000 ⁽¹⁾	Simulation	Reduced average cycle length by 58 percent; Reduced system travel time by 15 percent and reduced delay by 46 percent; Greatly improved intersection queue lengths, with the longest queue lengths averaging 88-percent shorter compared to the conventional design.
Reid and Hummer, TRB 2001 ⁽³⁾	Simulation	In comparison of different alternative intersections types over a variety of intersections, the quadrant roadway and median U-turn designs usually vied for the lowest average total time.
FHWA 2010 Alternative Intersection & Interchange Report (AIIR) ⁽¹³⁾	Simulation	Higher throughput/lower travel times for scenarios with heavy through and moderate left-turn volumes on the main street and heavy through and left-turn volumes on the cross street.
FHWA Tech Brief 2009 ⁽¹⁴⁾	Simulation	QR throughput showed a 5- to 15-percent increase in travel time and a 5- to 20-percent reduction in travel time compared to conventional intersections.
Reese, Carrol & Epperson 2014 ⁽³⁾	Field	40-percent reduction in intersection delay; significant reduction in intersection queues.

Results from 2000 ITE Study

Both the conventional and QR intersection traffic analysis models used the same coordinate and node system to allow equitable comparison of the system-wide MOEs using CORSIM. Signal timing designs for both the conventional and QR intersection design were optimized in Synchro. The simulation experiment included various levels of traffic volumes and splits:

- Level of Service (LOS) C and E intersection volumes.
- Both 55 and 70 percent roadway volume splits to represent balanced and more dominant traffic on the major street.
- Both 50 and 65 percent directional splits, representing balanced and directional traffic.
- Both 10 and 15 percent turn movements (applied equally to right and left turns), representing moderate and heavy left-turn volumes.

Signal and intersection geometric characteristics included:

- All QR intersections assumed protected-only left-turn phasing; the conventional design included fully-actuated signal control.
- The conventional intersections assumed dual left-turn lanes on the major street and single left-turn lanes on the minor street.

The factorial experiment included 64 simulation runs analyzing LOS conditions, volume splits, directional splits, and turn-movement percentages consistent for both conventional and QR intersections. System travel-time and delay times were measured in CORSIM by vehicle-hours and average speed. Stops per vehicle and maximum queues were computed for each link in the

network. Through and left turn travel times were examined for specific links. Intersection LOS and delay were computed from CORSIM results and post-processed to HCM standards. The MOE results for conventional and QR alternatives from the study are summarized in table 16.

Table 16. Summary of ITE study results.

Measure	Conventional	QR Intersection	Percent Difference
Cycle Length	142.0	90.0	- 58%
System Delay, veh/h	35.8	24.4	- 46%
System Travel Time, veh-h	66.9	58.2	- 15%
Stops per vehicle	0.71	0.78	+ 9%
Speed, mph	23.4	27.2	+ 14 %
Maximum queue, veh	23.4	12.4	- 47%
WB Left Travel Time, sec/veh	120.9	125.6	+ 4%
EB Left Travel Time, sec/veh	86.6	66.5	- 30%
Main intersection delay, sec/veh	41.2	13.5	- 215%
Main intersection LOS	E	B	N/R

Analysis results show the QR intersection had a 15-percent reduction in system travel time and a 46-percent reduction in system delay. The reduction in system delay is greater because QR left-turn travel distances are greater, but vehicles are in motion (not counted as delay) along the quadrant roadway. The QR intersection was shown to be considerably more efficient for through travel time, with a 30-percent reduction in through movement travel time. However, left-turn travel time was increased by 4 percent. The improvement in through-movement travel time greatly influenced overall intersection delay, which was reduced by 215 percent at the main intersection, and an improvement on average from LOS E to LOS B. The QR intersection also significantly reduced intersection queue lengths, with the longest queue lengths averaging 41-percent shorter compared to the conventional design.

Results from 2001 TRB Study

Seven different alternative intersections (including the QR intersection) were compared to a conventional intersection based on actual intersection volumes and characteristics. The authors obtained turning movement counts for seven existing, high-volume intersections in Virginia and North Carolina. Table 17 provides details on the selected intersections, including the number of lanes, roadway ADT volumes, and average percent turning movements.

Table 17. TRB study intersection evaluated.

Intersecting Roads	Location	Lanes (Main/Cross)	Percent Main Green	Percent Turns	Roadway ADT (Main/Cross) ^a	Intersection ADT ^a
Fairview Rd/ Sharon Rd	Charlotte, NC	4 / 4	0.59	38%	41,700 / 32,600	74,300
Byron Cameron/ Reston Pkwy	Arlington, VA	4 / 4	0.51	44%	30,700 / 29,000	59,700
US-70/Ebenezer Church	Raleigh, NC	4 / 2	0.85	34%	52,200 / 6,100	58,300
Sully Road/Old Ox Road	Arlington, VA	6 / 4	0.82	19%	64,500 / 20,300	84,800
US-74/Sharon Amity	Charlotte, NC	6 / 4	0.61	20%	66,300 / 30,900	97,200
US-64/Smithfield Road	Knightdale, NC	6 / 2	0.76	20%	46,500 / 9,500	56,000
US-1/New Hope Church Rd	Raleigh, NC	8 / 4	0.76	19%	73,300 / 16,300	89,600

Note: ^a Estimated based upon peak hour counts.

CORSIM simulation models were constructed for all seven conventional and alternative intersections using consistent volume inputs for all alternatives using O-D features in the CORSIM model. The conventional intersections were modeled with existing geometry and the QR intersections were modeled to match the conventional intersection turn lanes. Other assumptions included:

- Protected/permissive phasing was used for single-lane left turns and protected-only signal phasing was used for dual left turns, which is consistent with general signal timing practice.
- Intersection splits and signal phasing were optimized based on intersection volumes.
- Four cycle lengths were analyzed for each alternative: 90, 120, 150, and 180 seconds and the cycle length that produced the best (lowest) system time results were used.
- The experiment considered 3 different volume levels, including the PM peak hour volumes, off-peak volumes, and volumes at 115 percent of the PM peak hour volumes.

The experimental results were reported as total system travel time rather than intersection delays or similar measures. Alternative intersection designs can look very good at the main intersection while imposing large travel time penalties on left-turning vehicles at secondary intersections. Analyzing system-wide travel time inside a boundary constant between designs provide a more equitable comparison. CORSIM MOEs for QR intersections were compared to conventional intersections for each of the seven studied intersections, presented in table 18. Total system time and percent stop MOEs are reported for each of the three time periods and for an average of all three time periods.

Table 18. Summary of TRB study results.⁽²⁷⁾

Measure	Conv #1	QR #1	Conv #2	QR #2	Conv #3	QR #3	Conv #4	QR #4	Conv #5	QR #5	Conv #6	QR #6	Conv #7	QR #7
Off peak Total, v/h	67	64	50	48	37	34	73	74	112	89	36	31	36	31
PM peak Total, v/h	121	95	70	69	63	57	106	98	116	93	57	53	57	53
Peak+15% Total, v/h	170	135	91	83	103	73	146	125	179	124	66	57	66	57
Avg Total Time, v/h	120	98	70	66	68	55	108	99	136	102	53	47	53	47
Off-peak % Stops	0.73	1.10	0.74	0.98	0.59	0.60	0.71	0.94	0.46	0.90	0.68	0.60	0.68	0.60
PM peak % Stops	0.80	1.06	0.80	1.06	0.50	0.59	0.70	0.81	0.72	0.85	0.67	0.65	0.67	0.65
Peak+15% Stops	0.88	1.14	0.84	1.11	0.77	0.60	0.75	0.91	0.83	0.90	0.69	0.66	0.69	0.66
Avg % Stops	0.81	1.10	0.79	1.05	0.62	0.60	0.72	0.89	0.67	0.89	0.68	0.64	0.68	0.64
Average Cycle, sec	170	100	120	90	160	120	150	110	170	100	120	90	120	90
Average Veh-Miles	1936	2,088	1,620	1,704	1,464	1,573	2,419	2,550	2,484	2,664	1,460	1,525	1,460	1,525
Veh Avg Served	2849	2,937	2,384	2,384	2,148	2,261	3,562	3,577	3,646	3,765	2,146	2,202	2,146	2,202
Avg% Move Time	0.40	0.52	0.53	0.61	0.52	0.62	0.49	0.57	0.41	0.58	0.57	0.70	0.57	0.70

Source: TRB

The results show QR intersection had consistently lower system travel times for every PM and PM+15 percent volume scenario compared to a conventional intersection. In all but one case, the QR intersection had reduced system travel time, and in the one exception, system travel time was 1-percent greater (intersection 3). Despite the increase in vehicle stops under the QR intersection for all seven cases, there was a reduction in system travel time.

Results from FHWA AIIR Study

FHWA’s AIIR guide provided analyses that demonstrates how QR intersection design affects intersection throughput for several geometric conditions. Multiple simulation analyses were conducted for the AIIR guide comparing QR and conventional intersections under various volumes and geometric scenarios.⁽¹³⁾ Results showed QR intersections operated comparably to conventional intersections in cases of moderate and balanced through volumes on both streets. However, QR intersections had higher throughput and lower travel times compared to the conventional intersections in cases of high through and moderate left-turn volumes on the major street and heavy through and left-turn volumes on the minor street. In the latter scenarios, the increase in throughput ranged from 5 to 20 percent, and travel time savings were between 50 and 200 percent. Figure 74 compares throughput and average intersection delay of QR and conventional six-lane by four-lane intersection with multiple left-turn lanes under several different volume scenarios.

Simulation results showed that QR intersections performed comparably to conventional intersections for moderate and balanced through volumes on the major street. However, QR intersections had higher throughput and lower travel times compared to the conventional intersections for scenarios with heavy through and moderate left-turn volumes on the major street and heavy through and left-turn volumes on the minor street. For such scenarios, the increase in throughput ranged from 5 to 20 percent with 50 to 200 percent travel time savings.

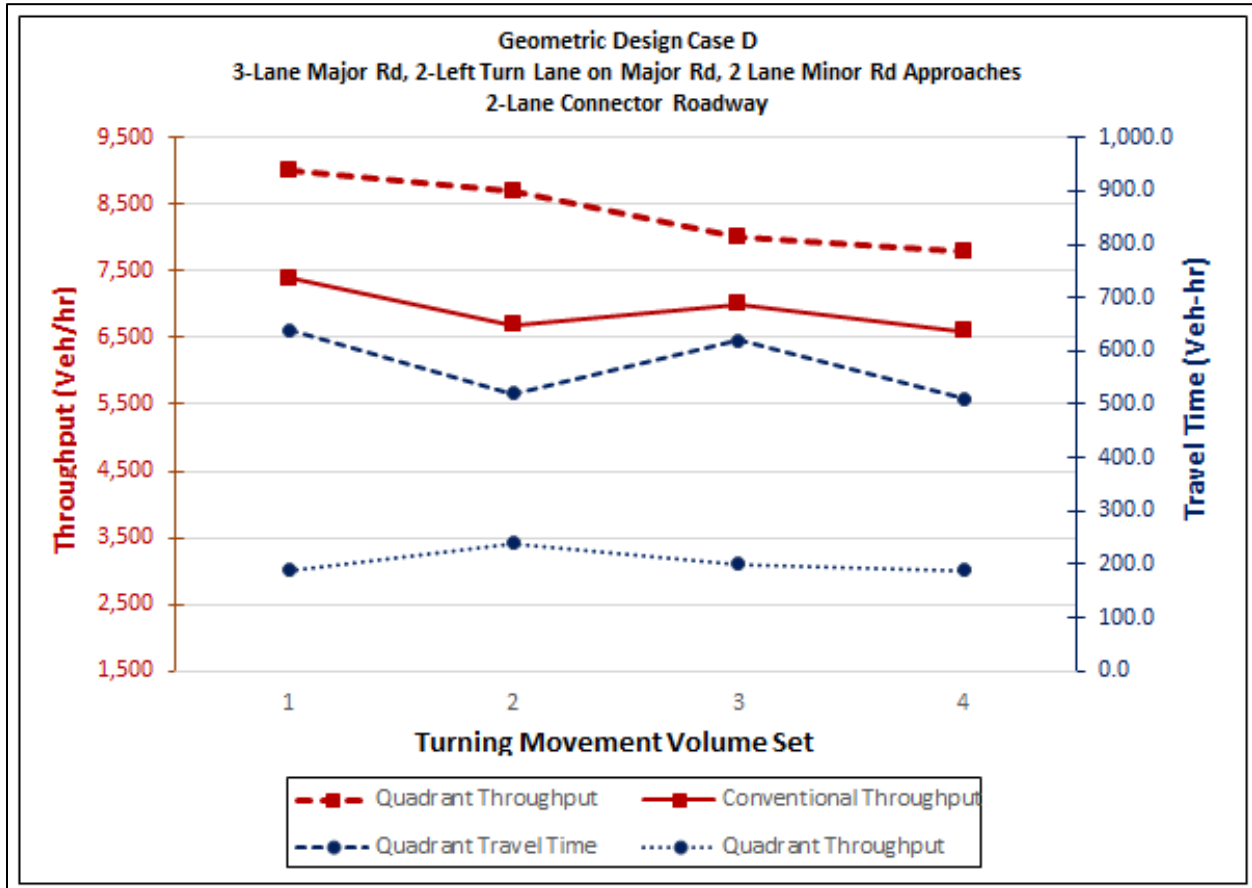

Source: FHWA

Figure 74. Graphic. Throughput comparison of QR versus conventional intersection.

Microsimulation analyses were conducted for four cases:

- A. Intersection of four-lane, two-way major street, two-lane, two-way minor street with one left-turn lane on the mainline, and a two-lane, two-way connector roadway.
- B. Intersection of four-lane major street, four-lane minor street with one left-turn lane on the mainline, and two-lane connector roadway.
- C. Intersection of six-lane major street, four-lane minor street with one left-turn lane on the mainline, and two-lane, two-way connector roadway.
- D. Intersection of six-lane major street, four-lane, two-way minor street with two left-turn lanes on the mainline, and four-lane, two-way connector roadway.

Simulation results showed:

- For case A, the conventional intersection performed slightly better compared to the QR intersection.
- For case B the conventional intersection was similar in operational performance compared to the QR intersection.
- For case C, the QR intersection was similar in operational performance compared to the conventional intersection.
- For case D, the QR intersection was significantly better than the conventional intersection in operational performance.

Results from Huntersville Study

Before construction of the NC-73 project, very poor operations occurred near the US-21 and NC-73 intersection during peak travel hours, frequently causing crashes and resulting in stopped traffic queuing across multiple adjacent intersections. Stopped queues on NC-73 would often extend from US-21 down the adjacent I-77 northbound ramp and onto I-77 during peak hours. If the QR intersection project was not constructed, 2030 peak hour delay could have worsened to predicted average delays of as much as 7-minutes per vehicle. Several operational safety studies were performed both prior to and post-construction:

- A comparison of 2030 No Build and 2030 Build QR intersection operations showed that the QR intersection improvements would reduce peak hour network delay by 46 percent.
- An operational capacity analysis was performed in 2014 by the North Carolina Department of Transportation (NCDOT) Congestion Management Section for the US-21 and NC-73 QR intersection and vicinity. At the time of the study in 2014, the intersection operated at overall LOS C with all movements operating acceptably at LOS D or better, and traffic queues did not extend down the I-77 northbound ramp onto I-77.
- Travel time runs were performed in May 2014 as part of the routine signal timing for the NC-73 corridor. A review of the actual travel time runs showed that in the AM peak hour on eastbound NC-73 (from the I-77 southbound ramp to Holly Point Drive), vehicles averaged 90 seconds to travel approximately 2,350 ft between these points at an average travel speed of 24 mph; in the PM peak hour, the westbound to northbound movement had a travel time of 95 seconds and an average arterial speed of 17 mph. These results showed that the capacity analysis described in the previous bullet was reasonably calibrated to actual field conditions if not slightly more conservative.

Capacity analysis was performed using 2014 AM/PM peak hour volumes to compare traffic operations with the QR intersection to how the intersection would have operated if the QR intersection would not have been constructed. Results showed that if the intersection reverted to a conventional all-movement intersection (with conventional turn lane improvements), the intersection would operate at overall LOS D, but near capacity with multiple movements operating at LOS F with some spillback and stopped queues on NC-73 would still extend from US-21 down the I-77 northbound ramp to I-77.

CHAPTER 6 — OPERATIONAL ANALYSIS

The previous chapter presented operational characteristics unique to QR intersections. To support decisions regarding the choice and design of a QR intersection, there needs to be an appropriate level of traffic operations analysis corresponding to the stage of the project development process. The level of analysis needs to be consistent with the available data, and that data needs to support the applied analysis tools. As vehicular traffic operations coincide with multimodal considerations, final intersection configurations and associated signal timing should be in balance with multimodal needs for each unique project context.

A QR intersection configuration is a system of multiple intersections, including the main intersections and two secondary T-intersections at either end of the quadrant roadway. Therefore, operational analysis must consider the operations of each signalized intersection and the relationship among all signalized intersections.

Necessary data to perform operational analysis may include the following elements:

- Average daily traffic (ADT).
- Speed (posted, design, or 85th percentile).
- Weekday and weekend peak-hour intersection turning movement counts.
- Weekday and weekend off-peak intersection turning movement counts.
- Pedestrian volume at the intersection.
- Bicycle volume at the intersection.
- Proportion of the traffic movements composed of heavy vehicles.
- Basic geometric data, including number of through and turn lanes and distances between the main and secondary T-intersections.

Measures of effectiveness are used to evaluate the operational efficiency of a particular design like the QR intersection. The FHWA Traffic Analysis Toolbox has identified the following seven basic measures of effectiveness for vehicle operations:⁽²⁹⁾

- Travel time: average time spent by vehicles traversing a facility, including control delay, in seconds or minutes per vehicle.
- Speed: rate of motion (expressed in distance per unit of time).
- Delay: additional travel time experienced by travelers at speeds less than the free-flow (posted) speed (expressed in seconds or minutes).
- Queues: length of queued vehicles waiting to be served by the system (expressed in distance or number of vehicles).
- Stops: number of stops experienced by the section and/or corridor (based on a minimum travel speed threshold).
- Density: number of vehicles on a street segment averaged over space (usually expressed in vehicles per mile or vehicles per mile per lane).
- Travel time variance: a quantification of the unexpected non-recurring delay associated with excess travel demand (can be expressed in several ways).

The final two measures, density and travel time variance, are less applicable to an intersection treatment than an uninterrupted flow facility, but may still be considered during the operational analysis. While average speed and travel time apply to the QR intersection much like they would to a conventional intersection (as long as the analysis area includes the entire configuration), the delay and stops performance measures must be carefully aggregated over the multiple intersections. Individual performance measures such as queues, stops, and delay across multiple intersections of a typical vehicle progressed through all intersections provides more meaningful comparisons versus simply adding or averaging the performance measures from each intersection.

OPERATIONAL ANALYSIS TOOL OVERVIEW

According to FHWA’s Traffic Analysis Toolbox, several tools are available to analyze traffic operations at intersections, including the following:

- Planning-level analysis, such as critical lane volume, CAP-X⁽³⁰⁾ and VJUST.⁽³¹⁾
- Highway Capacity Manual 6th Edition (HCM) analysis.
- Microsimulation analysis.

One major factor distinguishing these three types of analysis is the amount of time required to evaluate each scenario. HCM analysis may take several times as long as planning analysis, and microsimulation is typically an order of magnitude greater effort than HCM analyses. Planning-level tools are useful in the initial feasibility analysis and to conduct a high-level comparison of the approximate number of lanes for a QR intersection. An operational analysis using a deterministic method, such as the HCM, is useful to perform a more detailed peak-hour performance analysis and to estimate performance measures like delay, travel time, and queue lengths. The HCM analysis may provide insight on additional geometric design and signal timing details. Microsimulation is useful for alternative intersection forms like the QR containing multiple closely-spaced intersections for which an HCM procedure has not been explicitly developed. Table 19 provides a summary of available analysis techniques for QR intersections.

Table 19. QR intersection analysis techniques.

Planning	Highway Capacity Manual ⁽⁹⁾	Microscopic simulation
Available using critical lane analysis tool like CAP-X and VJUST	Difficult to perform now for motor vehicles; can analyze crossing pedestrians and bicycles. QR intersection-specific HCM procedure	Can be performed for motor vehicles, pedestrians, and bicycles with most simulation packages

Figure 75 shows how to translate conventional turning movements into QR intersection movements. Most analysis software designed for QR intersections (such as CAP-X described later) will make the translation automatically. Most microsimulation packages start with an origin-destination matrix rather than intersection-level turning movement data, but analysts using software not designed for origin-destination formatting or making manual calculations will have to make the translations. Figure 75 depicts the quadrant roadway in the southwest quadrant, but the volume assignments can be derived in the same manner for any intersection quadrant.

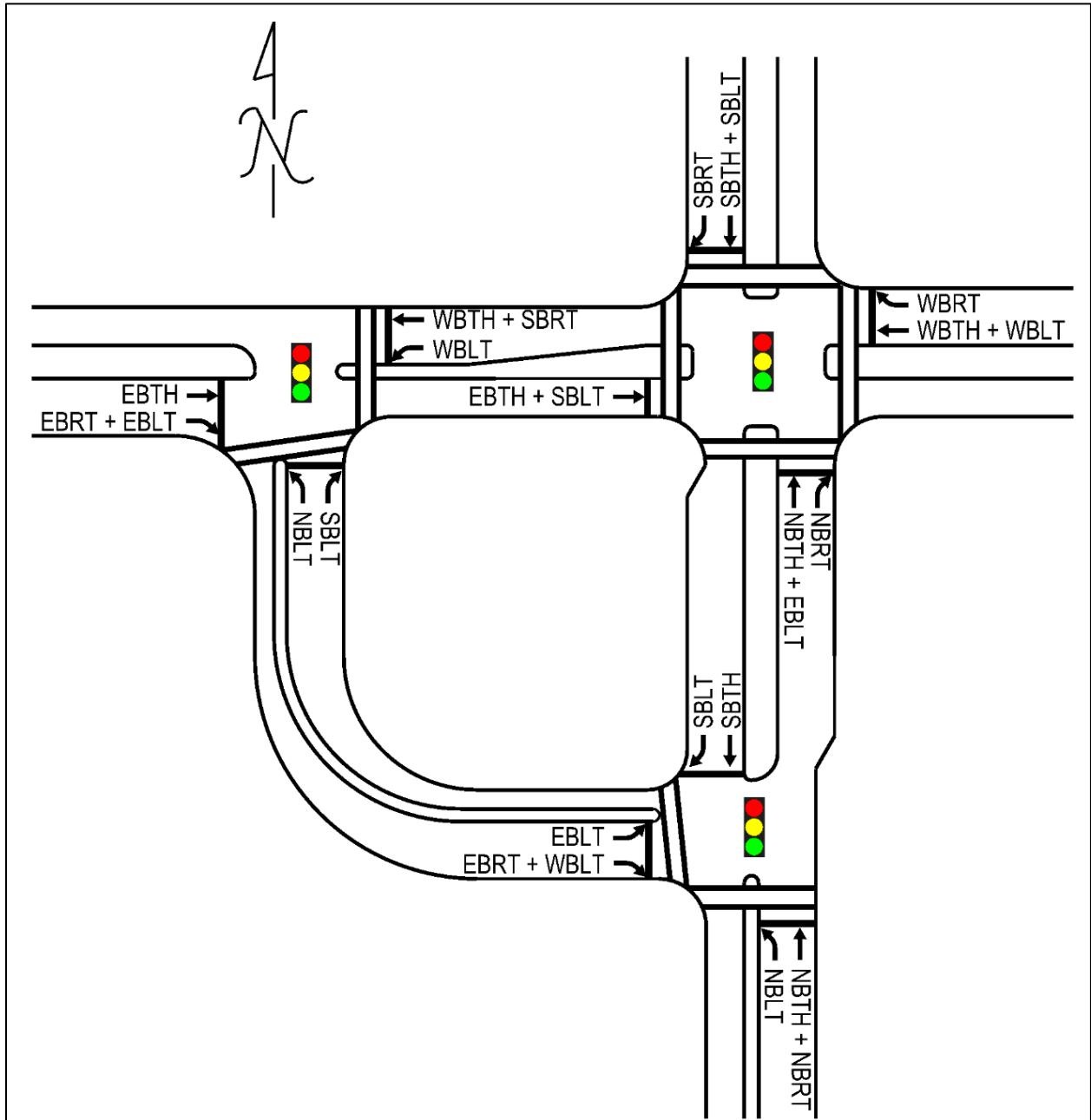

© NCDOT

Figure 75. Graphic. Translating turn movements from conventional to a QR intersection.

For one approach, there are two potential paths for right turns—one using the quadrant roadway and one advancing to the main intersection and turning right. The former is the shortest and perhaps most attractive path for motorists to make a right turn; however, the later path is the most conventional to motorists. The volume assignments in figure 75 assumes that 100 percent of the right turns use the quadrant roadway; however, the model can be calibrated to local conditions and preferences by splitting the percentage of right turns onto the quadrant roadway or at the main intersection. An example of conventional intersection turning movement volumes converted to a QR intersection volumes is shown in figure 76.

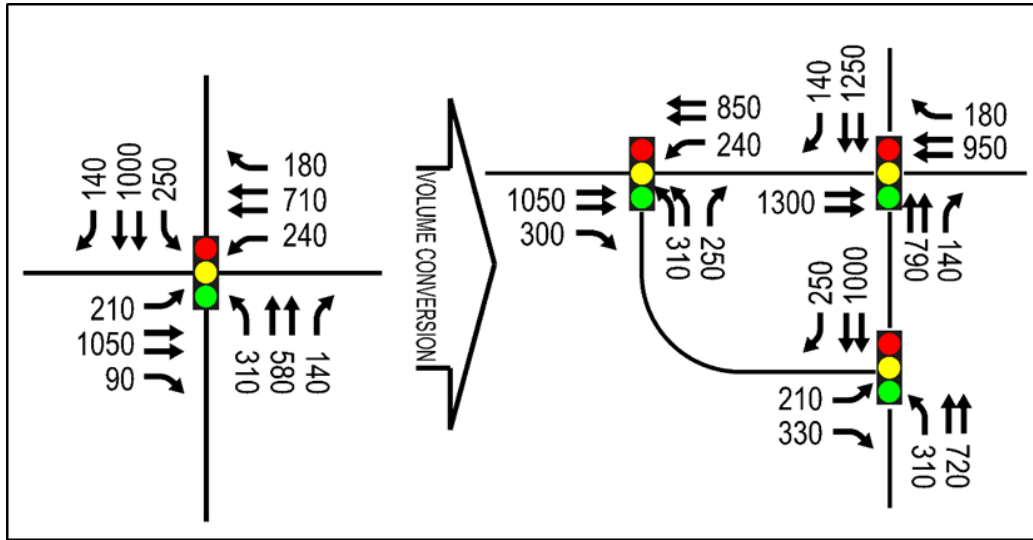

© NCDOT

Figure 76. Graphic. Converting conventional to QR intersection volumes.

PLANNING-LEVEL ANALYSIS

Planning-level tools and methods are useful in the early stages of a project when a QR intersection is being considered as an intersection improvement alternative. Planning-level tools and methods provide high-level analysis, typically providing no greater detail than volume-to-capacity (v/c) ratios and/or LOS computations. Travel time, delay, queue lengths, signal timings, and specific geometric data are typically not inputs nor outputs of planning-level tools. In general, planning-level analysis results are useful for feasibility and high-level design features but are not directly tied to actual operational performance or operational model results.

Critical Lane Capacity Analysis

The critical lane volume (CLV) summation technique estimates intersection capacity by viewing the intersection as a finite space shared by a set of conflicting traffic movements. For example, an eastbound left turn cannot be made simultaneously with the westbound through movement. Therefore, the east-west CLV is the sum of the eastbound left turn and westbound through volumes divided by the lanes available for each movement (or the westbound left turn and eastbound through movement divided by the lanes available for each movement—whichever is greater). The north-south CLV total is calculated in the same manner. The sum of the CLVs for east-west and the north-south becomes the basis for calculating the v/c ratio for the intersection. The intersection v/c can be correlated to LOS based on the ranges shown in table 20.

Table 20. V/C correlation to LOS.

V/C Ratio	Corresponding LOS
< 0.73	C or Better
0.73 – 0.85	D
0.85 – 1.0	E
> 1.0	F

The assumed per-lane capacity of each QR intersection movement is a key parameter in the planning-level results. The capacity in an operational analysis is derived from the saturation flow rate and the green-to-cycle-length ratio. In a planning-level analysis, the combined capacity of two intersecting lanes is estimated through the critical lane volume at the crossing point. This value is reduced from a base, uninterrupted saturation flow rate of 1,800 to 1,900 vehicles-per-hour-per-lane (vphpl) to account for lost time in the signal cycle. The typical critical lane volume used for all intersections in a tool like CAP-X is 1,600 vphpl. For the QR intersection, the saturation flow rate is higher due to the reduced lost time due to two-phase signal operations and the generally narrower intersection crossing distance compared to a conventional intersection. Table 21 provides the calculated values CLV capacities based on the number of signal phases.

Table 21. CLV capacity by number of signal phases.

Number of Signal Phases	CLV Capacity
2	1750
3	1675
4 or more	1600

As an example, using the given intersection turning movement volumes converted to a QR intersection volumes in figure 76, the procedure for calculating the CLV and corresponding LOS for both a conventional and QR intersection is provided in table 22. In the case of the QR intersection, the highest CLV among the three intersection governs overall LOS.

Table 22. Conventional and QR intersection critical lane capacity analysis.

Determinant	Conventional Intersection	Quadrant Rdwy Main Intersection	Quadrant Rdwy Secondary-T (1)	Quadrant Rdwy Secondary-T (2)
CLV for E/W movements (highest directional CLV)	1,050/2 + 240/1 = 765 -or- 710/2 + 210/1 = 565	1,300/2 = 650 -or- 900/2 = 450	1050/2 + 240/1 = 765	330/1 = 330 -or- 210/1 = 210
CLV for N/S movements (highest directional CLV)	580/2 + 250/1 = 540 -or- 1,100/2 + 310 = 810	1,350/2 = 675 -or- 790/2 = 245	310/2 = 155 -or- 250/1 = 250	1,100/2 + 310/1 = 810
Total (highest) intersection CLV	765+860 = 1,625	675+650 = 1,325	765+250 = 1,015	810+330 = 1,140
V/C ratio	1,625/1,600 = 1.02	1325/1750 = 0.76	1,015/1,750 = 0.58	1,140/1,750 = 0.65
Level of Service	LOS F (over capacity)	LOS D	LOS C	LOS C

CAP-X Software

For planning-level evaluation of QR intersections, the principal tool available is critical-movement analysis, as implemented in CAP-X.⁽³⁰⁾ CAP-X is a tool used to evaluate select types of alternative intersections, including the QR intersection, requiring only peak volumes inputs. The tool, easily implemented in a spreadsheet workbook, is designed to work using simple inputs including:

- Turning movement counts at both the main and secondary T-intersections.
- Heavy vehicle percentages.
- Number of lanes on each intersection approach.
- Estimate of future growth in traffic.

The outputs are the approximate v/c ratios at the main intersection and each of the secondary T-intersections. Figure 77 is a screen capture from the downloadable spreadsheet.

Note that when considering the result of the planning-level analysis, the worst intersection governs the operations of the entire QR intersection. In the CAP-X example shown in figure 77, the main intersection analysis results show an acceptable v/c of 0.51 and one of the secondary T-intersections has an acceptable v/c of 0.58; however, the other secondary T-intersection has an unacceptable v/c of 1.07 (slightly over capacity). In this case, the QR intersection would be considered unsatisfactory at a planning-level analysis.

However, the CAP-X may rank the QR intersection at or close to the top of a list of alternative intersection choices. In this case, the CAP-X tool could be used to evaluate if additional through or turn lanes can be added at the deficient secondary T-intersection to attain satisfactory operations. To evaluate any QR intersection design variation, the analyst would need to develop their own spreadsheet analysis consistent with the CAP-X methodology for evaluating CLV at each intersection. Another option would be to perform more detailed capacity analysis using other mesoscopic or microsimulation tools.

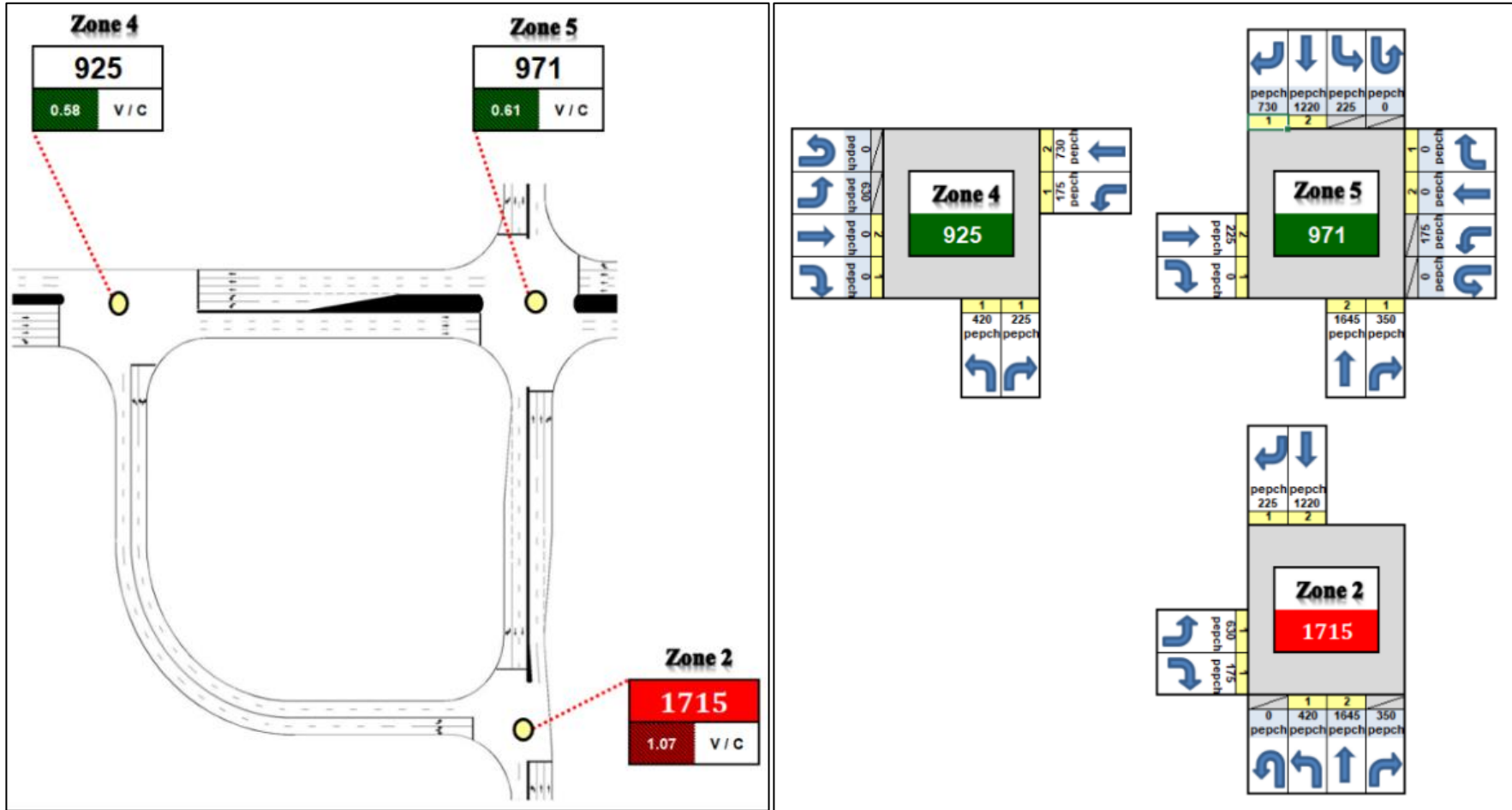

Source: VJUST

Figure 77. Graphic. CAP-X planning level tool screen capture for QR intersection.

HIGHWAY CAPACITY ANALYSIS ANALYSIS

Analytical methods and deterministic models to establish highway capacity, vehicular delay, and other performance measures are required for a more detailed analysis. The HCM, as well as Highway Capacity Software (HCS) and other types of software available from private vendors, can be used to perform this level of analysis.⁽⁹⁾ These tools use deterministic methods derived through analytical equations.

The operational analysis methods provide further insight into the operational effects of geometric design and signal timing elements of a QR intersection compared to planning-level analysis methods. Advantages of the operational-level analysis approach in the HCM include the ability to balance operational detail with reasonable data input needs and analysis resource requirements. The HCM method provides more detailed output in the form of delays, travel time, and queue estimates than the planning-level method, while allowing for more customization and consideration of geometric variability and signal timing details. At the same time, its methods are typically applied more quickly than a more resource-intensive simulation analysis. Another key advantage of the HCM over simulation analysis is that the deterministic analysis framework offers consistency in performance estimation across analysts and interchange options. The HCM is generally regarded as the benchmark for operational performance estimation, and its equations and LOS stratification form the basis of comparison with other tools.

Disadvantages of the current HCM include a limited scope of applicable geometry and lack of focus on network and system effects, including the interaction of the main and secondary T-intersections. Other operational characteristics of QR intersections not adequately handled by existing HCM methodologies include:

- The arrival and departure of vehicles between the main and secondary T-intersections (signal coordination).
- The potential for queuing to spill back from the main intersection through the secondary T-intersections.
- The added travel time associated with left-turn movements using the quadrant roadway.
- Potential for queuing in the single left-turn lanes on both intersecting roadways.
- The impact of transit stops within the boundary of the QR intersection.
- Estimation of pedestrian or bicycle level of service.

Current HCM analysis models analyze each intersection independently. Weaving movements and lane imbalance in positioning for downstream movements are not factored into the results. It is also not possible to cumulatively analyze the travel time and delay associated with left-turning movements that are made through a series of intersections. Vehicles are not “tracked” through the series of intersections, and thus the net impact to left-turn delay and vehicle travel time is not readily comparable to conventional intersection operations.

The RCUT Informational Guide provides a step-by-step procedure for calculating delay for indirect left-turn movements and integrating into the overall intersection delay calculations.⁽²¹⁾ This methodology has been adapted for determining the additional left turn delay at a QR intersection and the computational steps are provided below.

1. Given the turning movement demand estimate, redistribute the demands across the QR intersection as shown earlier in the chapter. For the remainder of this procedure, work with the redistributed demands.
2. Calculate control delays for all approaches to all three signals using the “incremental queue analysis” delay estimation methodology from Chapter 19 of the HCM.⁽⁹⁾ Mimic RTOR operations where applicable by analyzing approaches as if they had protected-permissive signals, with the appropriate critical gap and follow-up times.
3. Calculate queue lengths at each intersection storage bay and compare to actual storage bay lengths. If the 95-percent queue length exceeds the storage bay provided, and if spillback occurs, consider using microscopic simulation.
4. Use table 23 to determine the additional left-turn travel times for each movement (based on intersection spacing) using the estimated free-flow speed multiplied by the distance traveled.
5. Estimate the overall control delays for major street left turns, through movements, and right turns by adding the control delay from each of the three signals.
6. Estimate the extra travel time for the minor street left turn and through vehicles by adding the control delays from step 2 from each signal those vehicles traverse and the travel times from step 4.
7. Apply a LOS scale to the overall control delays and extra travel times from steps 5 through 6 if desired.

While the HCM has the limitations discussed above, it does provide the consistency agencies need for evaluating alternatives. The HCM is an international reference manual overseen by an independent committee of experts in the field, and thus is often the basis for policy decisions and LOS thresholds for intersection selection.

Level of Service Definition

The LOS of an entire QR intersection in the HCM can only be evaluated on an intersection-by-intersection basis. At present, there is no methodology for establishing an overall LOS grade for the QR intersection; rather the intersection evaluation should be based on the “worst” operations of the multiple signalized intersections within the QR intersection footprint. Evaluation of the approach delay and LOS should be rated according to the thresholds established in table 23, which is reproduced from the HCM.

Table 23. LOS criteria for signalized intersections.⁽⁹⁾

LOS	Control Delay (s/veh)
A	≤10
B	>10–20
C	>20–35
D	>35–55
E	>55–80
F	>80

Computational Steps

The basic methodology for analyzing QR intersection operations is shown in flowchart form in figure 78. The QR intersection methodology mirrors the HCM signalized intersection method (HCM 6th Edition Exhibit 19-18), but with additional considerations, including:

- Assigning conventional turning movements to the patterns permitted by the QR intersection’s geometry.
- Assuming optimal progression arriving at the main intersection and queues do not exceed available storage length.

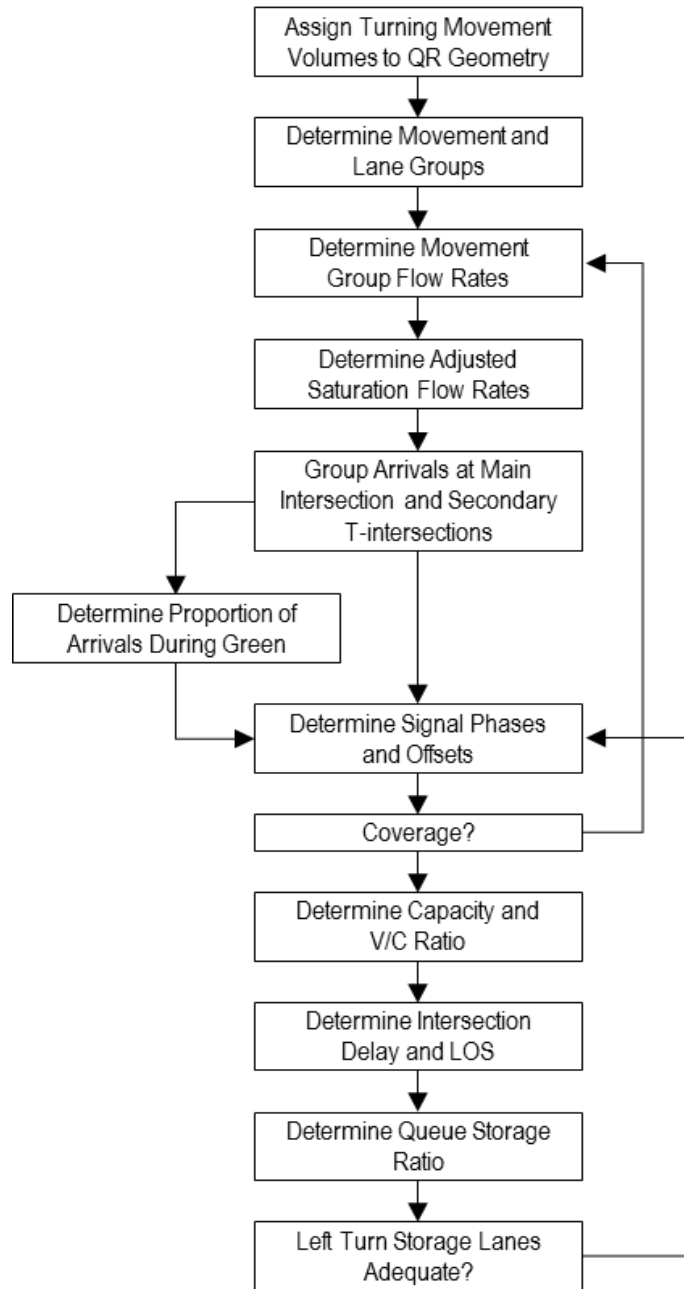

Source: Adapted from 6th Edition HCM Exhibit 19-18

Figure 78. Graphic. HCM method for QR evaluation.

A variety of input data are required to apply the HCM methodology to evaluate a QR intersection. These generally fall into the three categories of geometric, traffic and signalization conditions. Table 24 summarizes the input data needed for evaluating a QR intersection using the HCM methodology.

Table 24. Input data for HCM evaluation of QR.

Type of Condition	Parameter
Traffic Characteristics	Demand volume by O-D or turning movement Right-turn-on-red flow rate Percent heavy vehicles Intersection peak hour factor Platoon ratios Upstream filtering adjustment factor Initial queue Base saturation flow rate Lane utilization adjustment factor Approach speed Pedestrian flow rate Bicycle flow rate Local bus stopping rate
Geometric Design	Number of lanes Average lane width Turn bay lengths Approach grades Turning radii for all turning movements Distance between main and secondary T-intersections Existence of exclusive or shared left- or right-turn lanes
Signal Control	Type of signal control Phase sequence Cycle length Green times Yellow-plus-all-red change-and-clearance interval Offsets Maximum, minimum green, passage times, phase recall (for actuated control) Minimum pedestrian green Phase plan
Other	Analysis period 85th percentile, design, or posted speed Area type

Source: Adapted from 6th Edition HCM Exhibit 19-11

One of the key considerations in evaluating QR intersections in an HCM context is traffic signal optimization. The HCM methodology does not include a methodology for optimizing QR intersection traffic signals. Therefore, other tools are needed for optimizing QR intersection signal timing plans prior to implementation in the HCM or a simulation environment. To overcome this challenge, analysts often use off-the-shelf signal optimization tools to arrive at signal timing parameters for analysis of unbuilt QR intersections.

When optimization tools are not available, some simplified optimization techniques can be applied. Since all QR intersections operate with two-phase signals at the main intersection and three-phase signals at the secondary T-intersections, simple base signal timing assumptions can be developed by balancing the phasing split according to the proportional volumes on both intersecting roadways. Once the main intersection split is established, the secondary T-intersections can be developed to match the green time allocated for the opposite signal phase, and the offset is adjusted such that left-turn vehicles using the quadrant roadway are not unduly delayed by multiple stops. The base signal phasing assumption can be tested and modified using microsimulation analysis.

MICROSIMULATION ANALYSIS

Microsimulation analysis tools are capable of modeling the unique operational aspects of alternative intersections, including QR intersections. Capacity is derived from car-following models rather than static assumptions, and all intersections within a QR intersection configuration can be included in a single network. Among the more critical features required to accurately model QR intersections is the ability to replicate and track the turning movement patterns, including lane changing and lane assignment preferences. A list of calibration factors and validation parameters are described below. The selected tool must be able to include these. A discussion on the calibration process can be found on FHWA's Traffic Analysis Tools website in Volumes III or IV.⁽³³⁾

Advantages of microsimulation models include flexible customization and configuration of geometry, signal timing, and other operational parameters. However, the greatest advantage is that microsimulation models can output "system" measures of effectiveness for QR intersections, so that overall movement delay, travel times, and number of stops can be readily compared to conventional or other unconventional intersection designs. Post-processing tools can be constructed that use microsimulation data output to generate movement-specific MOEs, including measurement of travel time and speeds for each QR left-turn movement. Models can also generate safety-surrogate data such as stops and near-misses.

Disadvantages of microsimulation models include the time, budget, data required for input and proper calibration, and the knowledge of how to properly choose, set-up, run, validate, and obtain results. Another limitation of simulation is the need to calibrate and validate the effort, as well as the potential implications of failing to do so. The analyst needs to understand the many unique operational attributes of the QR intersection including saturation flow rate, speed profiles, lost time and gap acceptance, and know how to replicate those in simulation. There may also be variability in the results of QR intersection evaluations performed by different analysts.

Calibration Factors

Key data needed to establish calibration factors for QR intersection simulation models include:

- Field-measured free-flow speeds through all QR intersections. For calibration, speeds on the QR intersection roadway are below the free-flow speeds of through movement approaches, as discussed in chapter 5. If the model does not accurately reflect observed

field conditions, an alternate approach is to observe free-flow speeds from existing or similar roadways with similar intersection controls and driver behavior.

- Accurately modeling signalized control of QR intersections requires exploring whether the main and secondary T-intersections should be modeled with one versus multiple controllers. The selected tool should employ signal control logic that is flexible enough to allow modeling of multiple or single controllers. Details of QR intersection signalization strategies are presented in chapters 5 and 8.

Validation Factors

Several validation parameters are recommended for accurately modeling existing QR intersections in simulation. Data should be collected in existing conditions to support these parameters and the testing of the base conditions model, including:

- O-D volumes collected beyond the area of influence of the QR intersection footprint. A calibrated base model should be able to reflect similar volumes and travel patterns compared to existing field conditions. For QR intersections, the O-D patterns are adjusted and compared to the conventional intersection to match QR intersection geometry and permitted movements.
- Route travel times collected using GPS receivers, floating car, or other collection techniques. A calibrated model should be able to reflect similar travel times compared to existing field conditions.
- Average and 95th percentile queue lengths, particularly for through and left-turn movements. A calibrated model should be able to reflect reasonably similar queue lengths compared to existing field conditions.

SUMMARY

There are a range of tools that can be used for planning and operational analysis of QR intersections. Table 25 provides guidance on the advantages and disadvantages of using each tool and when each tool is best used in the planning and design process.

Table 25. Best use of analysis tools.

Analysis Tool	Advantages	Disadvantages	Use When Conducting...
CAP-X /other planning-level	Simple inputs and results	Many default assumptions; difficult to calibrate	Most planning-level analysis
HCM or other macroscopic	Simple inputs and LOS outputs	Does not consider interaction between signals	Planning level analysis with deeper knowledge of default values
Microscopic Models	Detailed operational results and MOEs by movement	More time consuming to code and post-process to obtain LOS results	Operations level analysis or to test and implement signal timings

CHAPTER 7 — GEOMETRIC DESIGN

This chapter describes the typical QR intersection design approach and provides guidance for geometric features. This chapter presents best practice design criteria developed by experienced local and State agencies, and also provides information regarding implementations in several States. It requires input from the multimodal considerations (chapter 3), safety assessment (chapter 4), and traffic operational analysis (chapters 5 and 6). The guidance in this chapter is intended to supplement national resources on intersections that apply basic design principles.

DESIGN APPROACH

Developing the geometric layout for an intersection configuration requires considering the relationship and interaction of safety, operations, and design. In addition, it requires understanding the trade-offs of the physical, environmental, or ROW constraints for the proposed QR intersection that may preclude ideal median width or crossover location. As with any intersection form under consideration, undesirable geometry cannot necessarily be mitigated by signing and pavement markings. The overarching goal is to provide geometry that serves various users and meets their expectations. This includes clear and defined geometrics that are supplemented with signing and pavement markings. Figure 79 highlights the characteristic features of a QR intersection with signals at the main and secondary T-intersections.

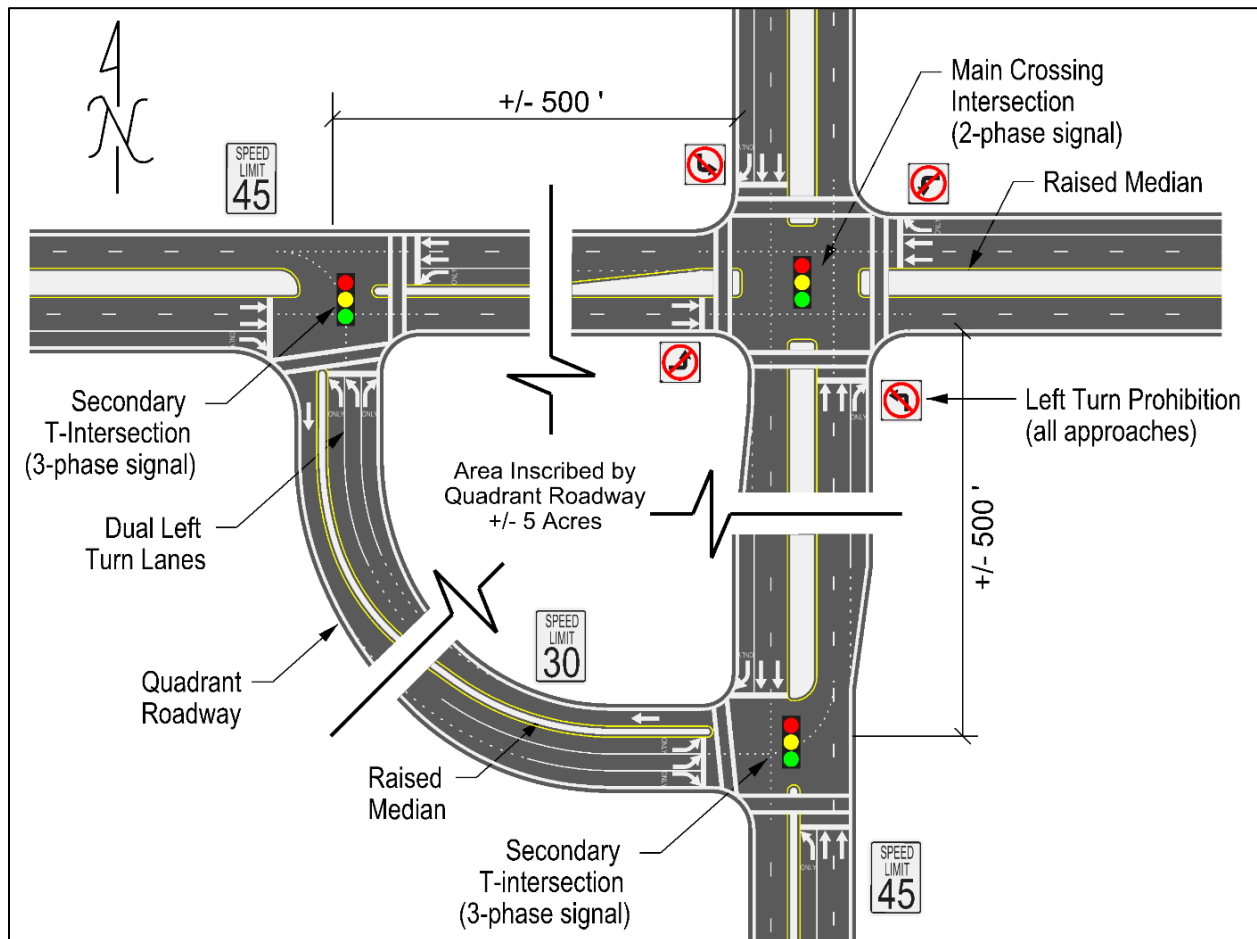

© NCDOT

Figure 79. Graphic. QR intersection characteristics.

GEOMETRIC DESIGN PRINCIPLES

The geometric design of a QR intersection introduces some unique design elements not typically present at a conventional intersection. These elements include:

- The roadway in one intersection quadrant, either constructed new as part of the QR intersection or an existing street that is repurposed to function as the quadrant roadway.
- Potential change in access to land uses in the four intersection quadrants compared to a conventional intersection, resulting in access strategies and management considerations to promote safe and efficient access to adjacent properties.
- Closely spaced signals on both crossing roadways that require coordination.
- Restriction of left and U-turns at the main intersection, enforced by positive guidance using design elements and/or traffic control devices to reduce chances of driver error.
- Signing, marking, and geometric design promoting safe and efficient movements that would otherwise be unexpected or unfamiliar to motorists.

GEOMETRIC DESIGN PARAMETERS

QR intersections can have a variety of design characteristics to accommodate specific location context and access demands. The number of lanes on the quadrant roadway and the land use and functionality within the intersection quadrant can impact access management and ROW along both crossing roadways.

Speed of the Quadrant Roadway

As previously described in chapter 4, the recommended spacing between the main and secondary T-intersections should be approximately 500 ft based on minimum breaking distances between intersections and queue storage demands. It is desirable to have a minimum 100-ft tangent distance coming out of the curve approaching the secondary T-intersections to transition out of any superelevation and allow vehicles to align at 90 degrees at the stop bar.

Given the short link distance and potential queues on the quadrant roadway, the roadway should be designed as a low speed urban roadway with *posted* speed range of 25 mph or 30 mph. According to AASHTO criteria, the corresponding horizontal curve radius for a 25-mph low-speed roadway (DS=30) with a superelevation rate of 4 percent is 250 ft, and for a similar 30-mph roadway (DS=35), the radii increases to 371 ft.⁽¹²⁾ Greater curve radii *may* be used (particularly if a current roadway is being repurposed), but a larger radii encourages higher speeds than desired on the quadrant roadway. This basic QR intersection criteria is presented in figure 80 and figure 81 for speeds of 30 and 35 mph, respectively.

Superelevation

Because of the desired low-speed operations of the quadrant roadway, a maximum superelevation of 4 percent is the greatest superelevation that should be considered. With this superelevation rate, drainage outlets would need to be placed in the desired center raised concrete island. However, with lower speed design, superelevation may not be critical, thus eliminating the need for drainage catch basins in the center island.

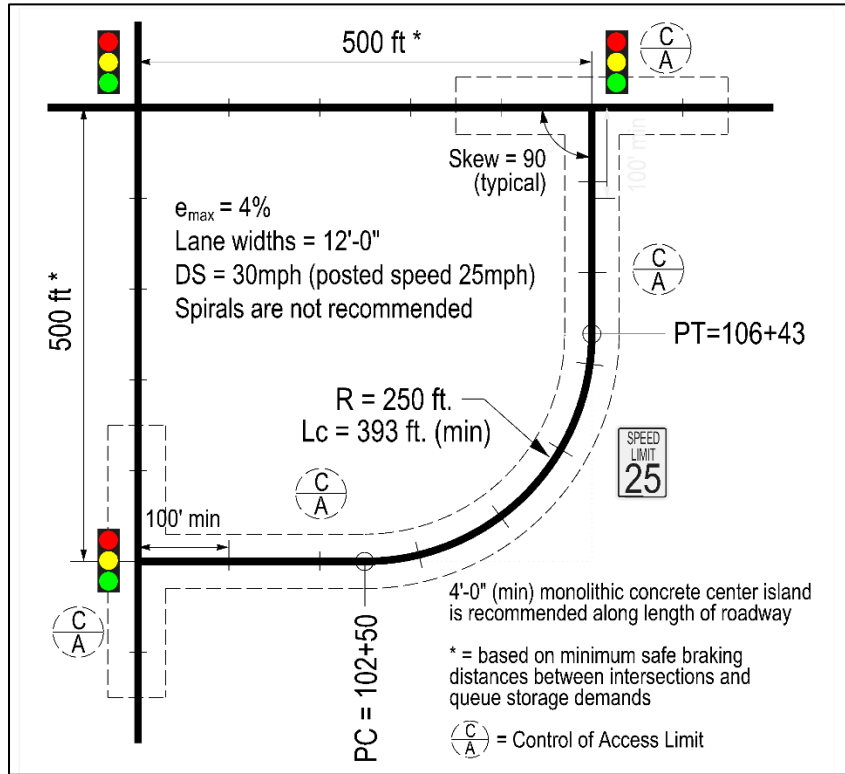

© NCDOT

Figure 80. Graphic. QR intersection geometric design (DS=30mph).

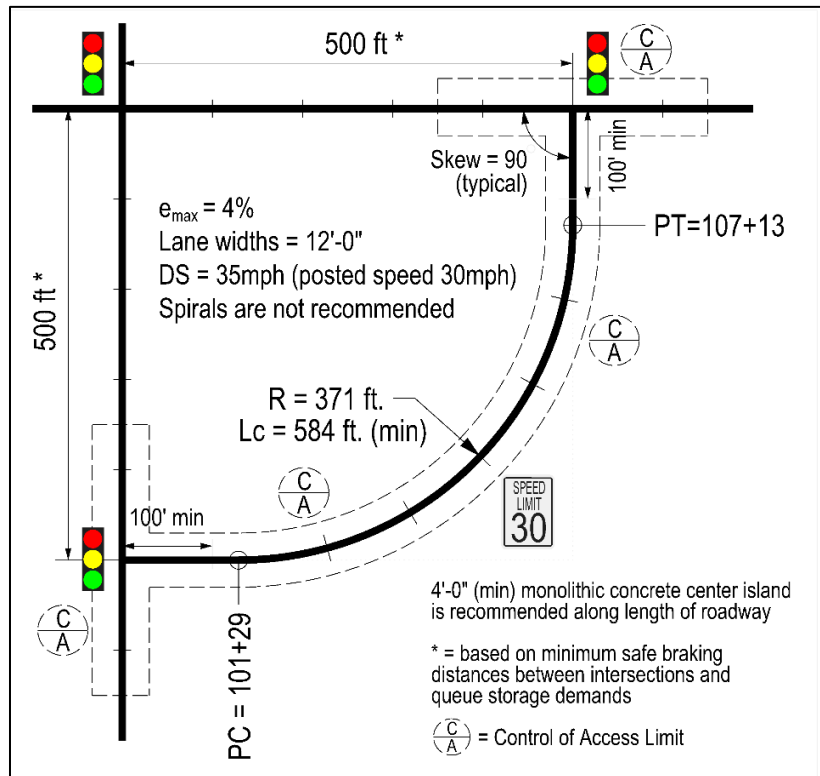

© NCDOT

Figure 81. Graphic. QR intersection geometric design (DS=35mph).

Number of Lanes on the Quadrant Roadway

The planning phase of a QR intersection should include an analysis of the number of through and turning lanes required on the quadrant roadway to provide safe and efficient operations. Strong consideration should be given to lane assignment and vehicle paths through the quadrant roadway to reduce weaving movements along the quadrant roadway. Figure 82 through figure 84 illustrate three potential QR lane geometries, with a description of each lane geometry scenario following the figures.

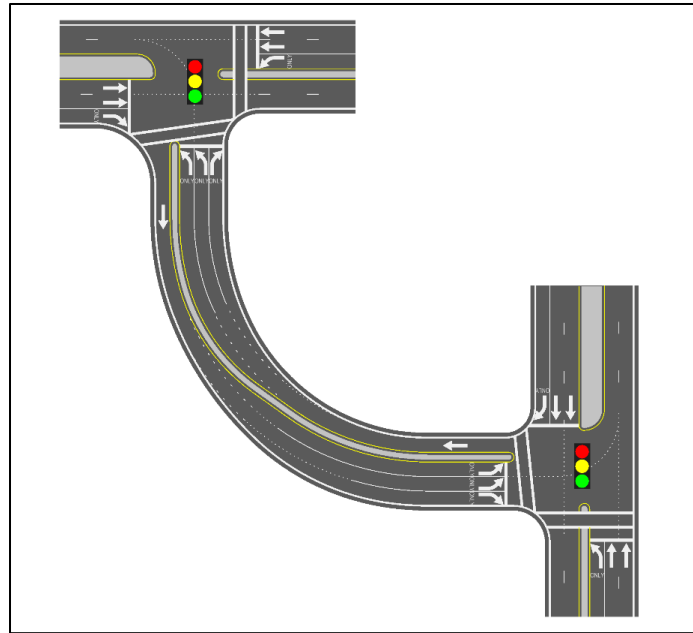

© NCDOT

Figure 82. Graphic. Two-lane quadrant roadway.

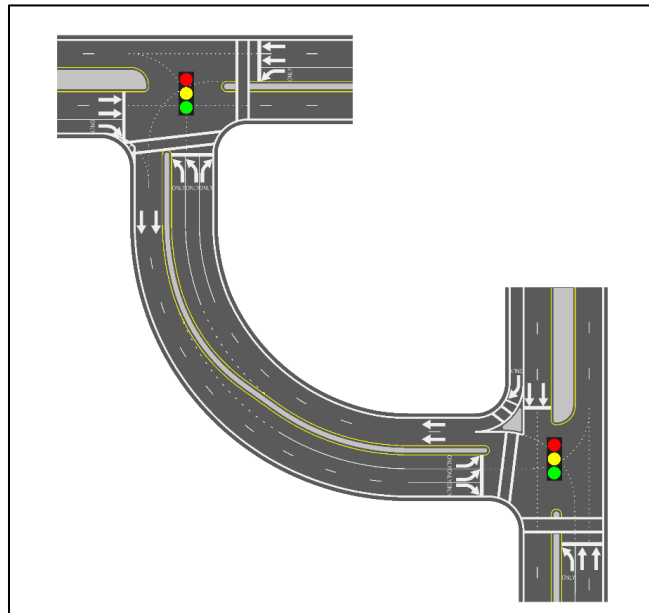

© NCDOT

Figure 83. Graphic. Four-lane quadrant roadway.

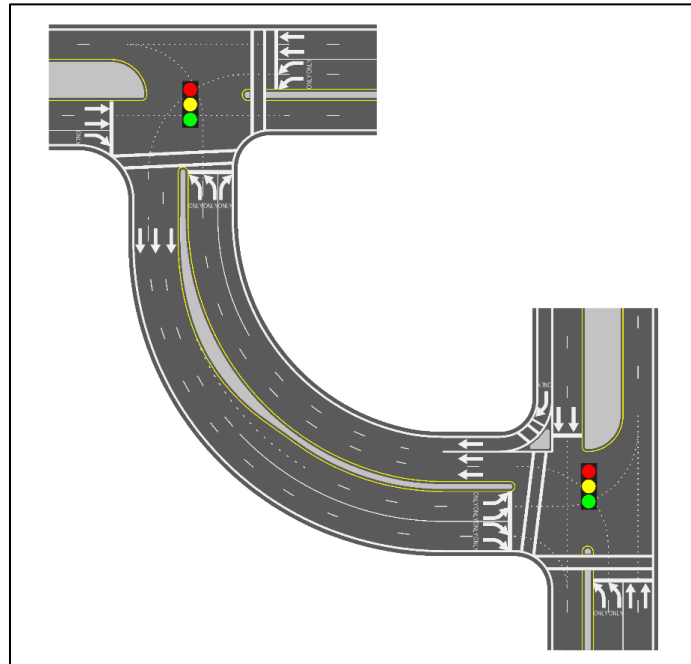

© NCDOT

Figure 84. Graphic. Six-lane quadrant roadway.

Two-lane quadrant roadway (figure 82): If there are only single left-turn lanes onto the quadrant roadway, the quadrant roadway can adequately store queue demands, and there are no intermittent driveways on the quadrant roadway, a two-lane quadrant roadway may be appropriate. This configuration includes one continual through lane in each direction and a shared third lane to create back-to-back left-turn lanes at both ends of the quadrant roadway. A separate right-turn lane can be developed if dual left-turn lanes are warranted. The single right-turn lane is typically sufficient as right turns are given more green time. Right turns are permitted during both the quadrant roadway phase and as a right-turn overlap with the left turn entering the quadrant roadway. If access is allowed along the quadrant roadway, a continuous raised median should traverse the entire length of the quadrant roadway to manage access to RIRO or directional openings only.

Four-lane quadrant roadway (figure 83): If additional queue storage is determined to be needed (or if an intermediate break in the median is necessary), the quadrant roadway can be expanded to four lanes, two continuous lanes in each direction plus a back-to-back left-turn lane and single right-turn lane. It is recommended to use lane guidance striping and/or lane guidance signing to align right- and left-turn lanes with the lanes on the quadrant roadway that ultimately turn right or left leaving the quadrant roadway. Also, one of the right turns (the left turn that circles the quadrant roadway in a clockwise direction) can be made free-flow onto the quadrant roadway; however, this would be an impact to pedestrians.

Six-lane quadrant roadway (figure 84): If multiple right- or left-turn lanes are needed turning onto the quadrant roadway at either secondary T-intersection, or analysis shows the need for additional queue storage on the quadrant roadway, a six-lane quadrant roadway may be appropriate. In this case, lane assignments must be carefully considered to avoid forcing either right- or left-turning lanes entering the quadrant roadway to change lanes to reach their desired exit lanes. A six-lane configuration was used at the SR-4/SR-4 Bypass QR intersection, but with single left turns from both intersecting roadways onto the quadrant roadway.

Stopping Sight Distance

A low-speed quadrant roadway requires less stopping sight distance, such that typical curb and gutter and sidewalk widths may provide adequate clear zone sight distance along the roadway. If there are RIRO or directional access points along the quadrant roadway, clear sight-distance triangles should be provided and maintained at the access point.

Lane Widths

There are no special lane width requirements for any of the roadway elements in a QR intersection, so lane widths of 11 or 12 ft are generally sufficient. If there are single-lane segments on the quadrant roadway, wider lane widths should be considered and/or shoulder width provided as room for vehicles to pass a stalled vehicle in the single lane. Lane widths may need to be adjusted if Tractor-Trailer/ Semi-Truck (TTST) vehicle traffic is considered significant. Also, intersection geometry and median and curbs should be designed to accommodate the selected design vehicle passing through the intersection.

Design Access Controls

Every effort should be made to preserve T-intersection operations at both ends of the quadrant roadway. The best case would utilize physical features to control access, such as a lake, steep grade, or permanent structures in the natural path of a fourth leg to limit a future roadway. If physical restrictions are not possible, granting a limit of access line across the top end of the T-intersection would allow State or governing jurisdictions to deny a future roadway. If neither is possible and/or if local development and/or access pressures would otherwise stop a QR intersection project, a compromise of a fourth leg with restrictive covenants could be considered.

If the quadrant roadway is constructed as a new roadway and connectivity can be provided from either intersecting roadway to land parcels in the intersection quadrant containing the quadrant roadway, prohibiting access to the quadrant roadway can be ensured by establishing a control of access on the outside and the inside of the quadrant roadway for its entire length between the secondary T-intersections.

Area Inscribed by the Quadrant Roadway

Using 500-ft secondary T-intersection spacing and 250-ft curve radius design parameters previously described in this chapter, the area inscribed by the quadrant roadway is approximately 5 acres. Ideally, this land is preserved as part of the intersection through purchase and access to the quadrant roadway is limited. One corresponding use may be as a bioretention pond, as included at the Front Royal QR intersection as shown in figure 85.

The preservation of land and control of access may not always be possible in urban or suburban areas where corner parcels at busy intersections are prime real estate, or in the case when the QR intersection repurposes an existing roadway. In this case, every effort should be made to control access to the quadrant roadway to RIRO by installation of a raised median the length of the quadrant roadway. If intermediate access to land uses adjacent to or inscribed by the quadrant roadway is required, left turns should be permitted only *from* the quadrant roadway using directional left-turn channelization in the median, avoiding full median breaks.



© NCDOT

Figure 85. Photo. Use of parcel inside quadrant roadway for bioretention pond.

OPERATIONAL EFFECTS OF GEOMETRIC DESIGN

This section addresses the operational effects of geometric design on safety performance, traffic operations, and quality of service for pedestrians and bicyclists. There are several geometric design features potentially affecting how the QR intersection will operate once implemented.

Preservation of Secondary T-Intersections

Allowing a fourth leg at one or both of the secondary T-intersections can negatively impact secondary T-intersection operations, overall QR intersection effectiveness and ultimately driver perception of a QR intersection. The main intersection (two critical phases) can be coordinated with the secondary T-intersections (three critical phases) to operate with an overall efficiency of a two-phase signal. The addition of a fourth leg to either of the secondary T-intersections can introduce additional critical signal phases that compromise signal timing and coordination with the main intersection and elevate the secondary T-intersection to control overall QR intersection operations. However, commercial, retail, or residential developers (current or future) will view the signalized T-intersections as ideal locations to gain access to either intersecting roadway.

Figure 86 and figure 87 illustrate the secondary T-intersections that are preferred and to be avoided, respectively.

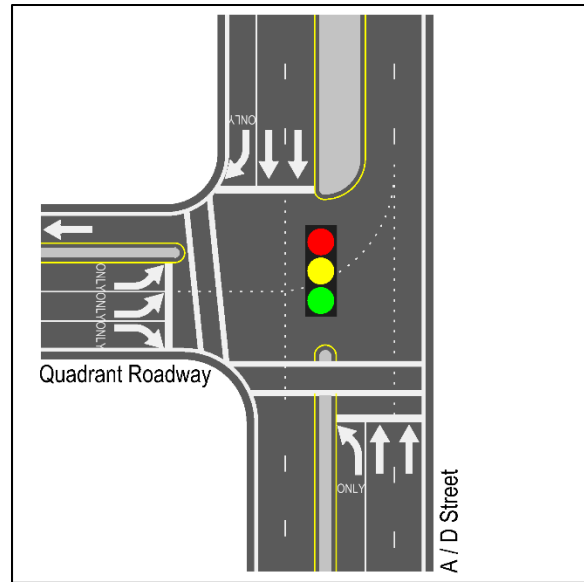

© NCDOT

Figure 86. Graphic. Preferred secondary T-intersection geometry.

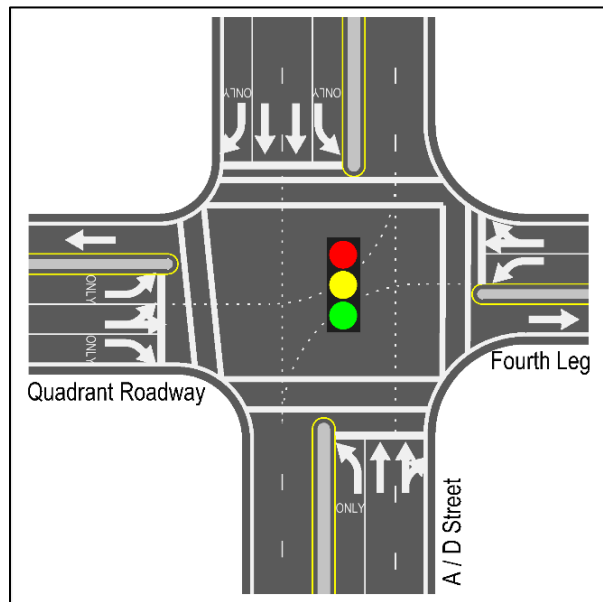

© NCDOT

Figure 87. Graphic. Secondary T-intersection geometry to avoid.

Recognizing that access needs may be political in nature, several compromise design scenarios have been developed that minimize the operational impacts of providing a fourth intersection leg. Note that in all of these compromises, the secondary T-intersection maintains three critical signal phases coordinated with the two-phase main intersection. However, each compromise may create additional pedestrian and/or bicycle conflicts and increase the potential for driver confusion. These compromise scenarios are illustrated and described in figure 88 through figure 91.

Compromise 1: Allow through movements from the quadrant roadway across to the fourth leg while allowing only right turns from the fourth leg. The through movement can be served in the same signal phase with the quadrant roadway left turns in a shared through / left lane (or an exclusive through lane as volumes demand). The fourth-leg right-only movement may be yield controlled or free-flow into a right-turn or merge lane.

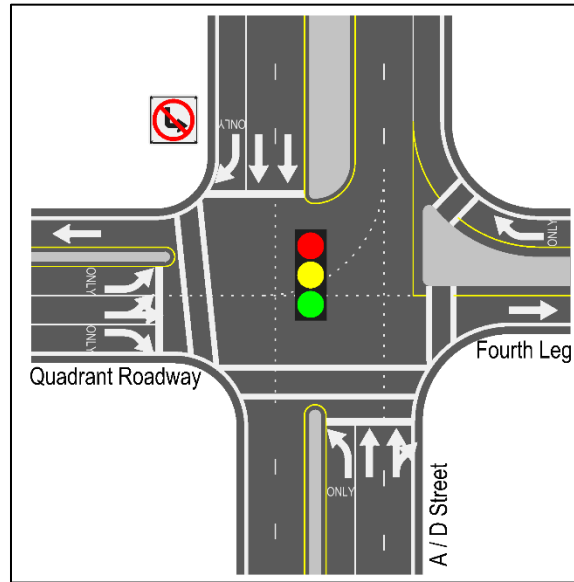

© NCDOT

Figure 88. Graphic. Secondary T-intersection compromise 1.

- **Compromise 2:** Allow right- and left-turn lanes *exiting* the fourth leg (but no through movement). The fourth-leg left turn can occur during the signal phase serving left turns exiting the quadrant roadway. The fourth-leg right-only movement may be yield controlled or free-flow into a right turn or merge lane. A caution with this compromise is that the prohibition of through movements (from both the quadrant roadway and from the fourth leg) may not be intuitive to motorists and may be difficult to control geometrically.

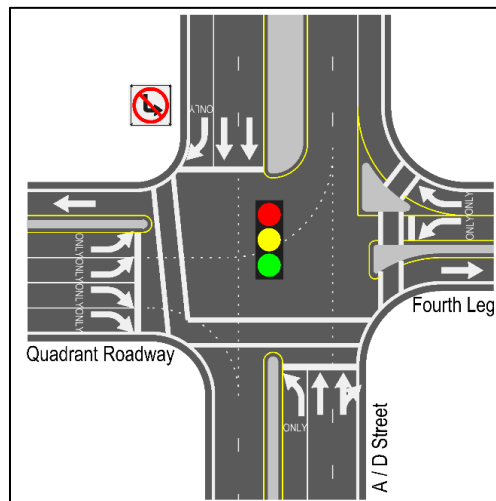

© NCDOT

Figure 89. Graphic. Secondary T-intersection compromise 2.

- Compromise 3:** Similar to compromise 2 but allow left turns to and from the fourth leg and prohibit through movements from the both the quadrant roadway and fourth leg. Note that the intersection still has three critical phases, and the added movements may degrade capacity and/or vehicle progression and may encourage undesirable paths to avoid using the QR intersection as intended.

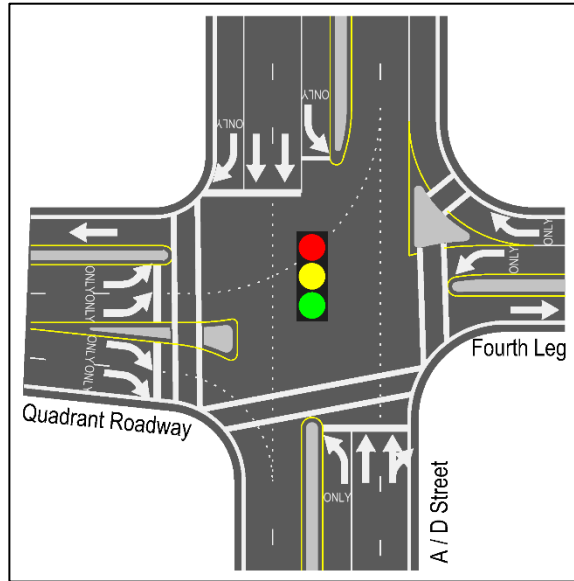

© NCDOT

Figure 90. Graphic. Secondary T-intersection compromise 3.

- Compromise 4:** Construct a four-leg, full-access intersection, but operate the intersection with seven signal phases including three critical phases.⁽³⁴⁾ Volumes on the outbound left turns from the fourth leg must be low to be served in the same phase as the quadrant outbound left. If the fourth-leg left turn or quadrant roadway through volumes are significant, intersection operations may degrade and thus impact the overall effectiveness of the QR intersection.

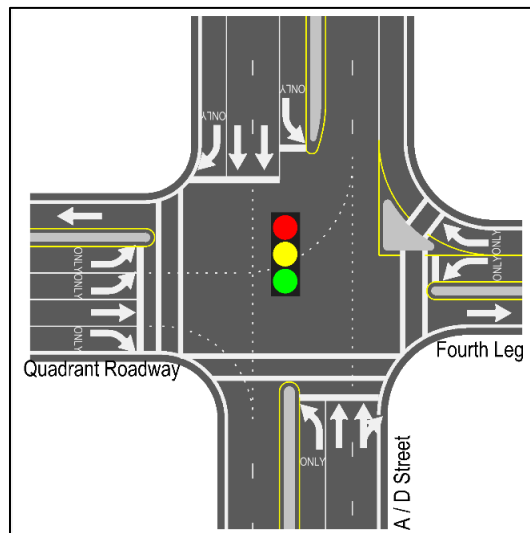

© NCDOT

Figure 91. Graphic. Secondary T-intersection compromise 4.

Lesson Learned: Huntersville QR Intersection

The Huntersville, North Carolina QR intersection is an example of a QR intersection where fourth legs were included at the secondary T-intersections. As illustrated below, the downstream secondary T-intersection on NC-73 permits direct left turns into a pre-existing shopping center driveway, a political mandate in order for the project to move forward. Despite proper markings and overhead signing directing motorists to use the quadrant loop, many motorists thought they would save time by turning left at the secondary T-intersection, traversing the shopping center internal loop roadway and finally making a right turn at the end of the loop road to complete the left onto northbound US-21 (path identified in the graphic below). While this is a shorter left-turn distance, travel time studies showed the intended QR left turn path provided the shortest left-turn travel time. Nonetheless, the internal loop road was unintentionally inundated with additional “through” trips.

After the QR intersection project was complete, NCDOT and the Town of Huntersville wrestled with several options to remedy the situation, and ultimately a combination of traffic calming, education, and signal timing adjustments mitigated the adverse condition. Today, motorists generally find the designated quadrant roadway path to be preferable. Takeaways from this experience are: 1) avoid fourth legs at secondary T-intersection wherever possible; 2) where a fourth leg compromise is needed, expect that motorists will seek the perceived shortest path; and 3) proactively use design, traffic calming, and access management strategies to ensure that motorists use the preferred left-turn path along the quadrant roadway as intended.



© NCDOT; Background image © 2018 Google ® Earth™

Figure 92. Graphic. Huntersville QR intersection access lessons learned.

Skewed Intersections

At conventional intersections, acute skewed left turns have a detrimental impact on intersection operations and safety. In some cases, skewed intersections afford the QR intersection to have operational and safety advantages compared to conventional intersections, as the hard-left turns are eliminated at the main intersection, which is particularly beneficial to larger vehicles.

At skewed intersections, left turns both to and from the quadrant roadway can (and should) be made at 90-degree angles to both intersecting roadways. If the quadrant roadway is located in the acute angle of the intersecting roadways, the quadrant roadway left-turn paths are shorter; however, significantly acute intersection angles could lead to insufficient storage on the quadrant roadway and/or longer spacing between the main and secondary T-intersections, which increases left-turn travel distances. Quadrant roadways located in the obtuse angle of a skewed intersection are typically undesirable, as the length of the quadrant roadway becomes significantly longer to achieve 90-degree angles with both intersecting roadways. This leads to longer left-turn travel distances and increased ROW and construction costs. Figure 93 and figure 94 illustrate the preferred acute and undesirable obtuse angles for quadrant roadways at skewed intersections.

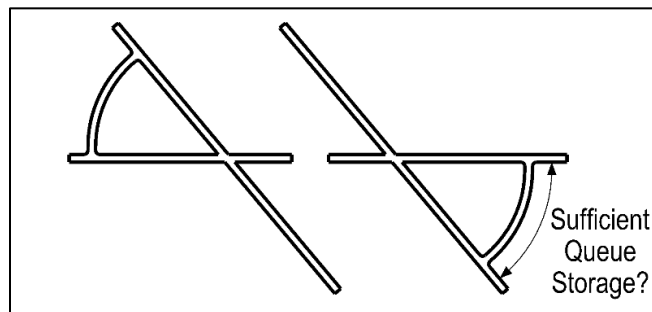

© NCDOT

Figure 93. Graphic. Preferred quadrants at skewed intersections.

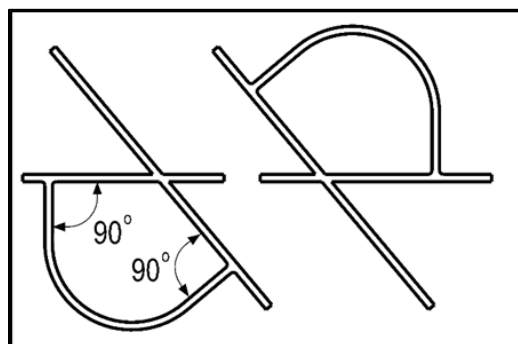

© NCDOT

Figure 94. Graphic. Undesirable quadrants at skewed intersections.

Free-Flow Right-Turn Lanes

Similar to conventional intersections, the following elements need to be considered when designing free-flow right-turn lanes if implemented at QR intersections:

- The geometry at the pedestrian crossing in the 90-degree turn minimizes the speed difference with pedestrians at the crosswalk.

- Stopping sight distance for the approaching motorists and sight distances for the pedestrians approaching the potential oncoming automobiles should be clear of obstructions and provide sufficient visibility for various users.
- The location of the weaving/merging segment (where the free-flow right turn rejoins the through traffic exiting the intersection) in relation to the next decision point downstream of the intersection needs to be evaluated to minimize weaving beyond the intersection. It may be necessary to signalize the right turns as part of the crossover signal to eliminate a potential downstream weaving/merging segment.
- Driveways within the weaving/merging areas need to be avoided to minimize unexpected deceleration and unexpected maneuvers.

Figure 95 and figure 96 show two options for channelized right turns:

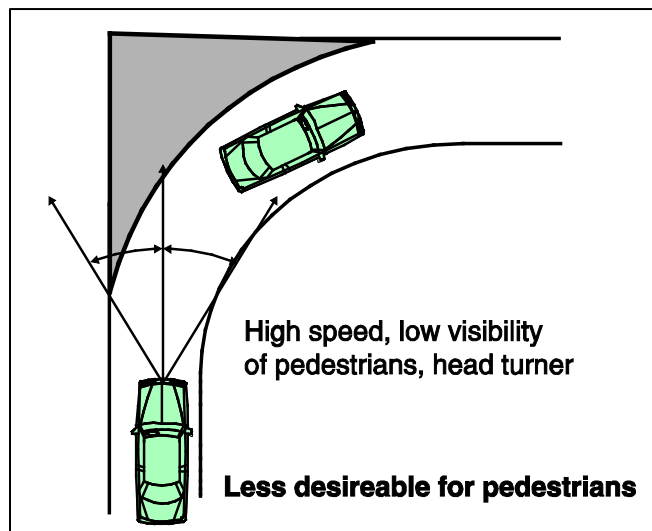

Source: FHWA

Figure 95. Graphic. Types of channelized turns (1).⁽²¹⁾

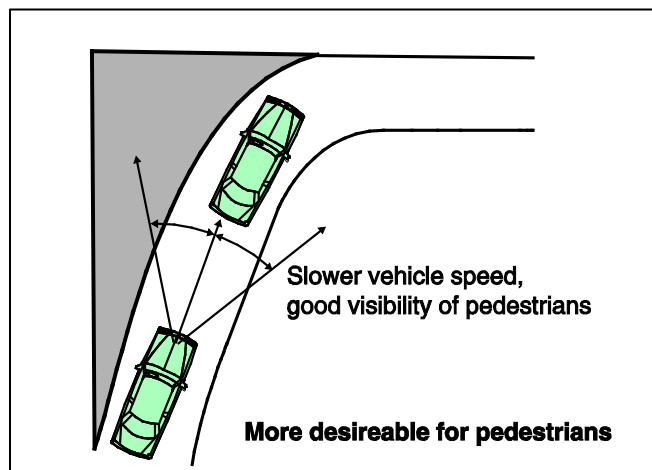

Source: FHWA

Figure 96. Graphic. Types of channelized turns (2).⁽²¹⁾

DESIGN GUIDANCE

The next few sections discuss key geometric design guidance for QR intersections:

- Pedestrian crossings.
- Main intersection left-turn prohibitions.
- ROW requirements.
- Medians.
- Design vehicle.

Pedestrian Crossings

The narrower street typical section of a QR intersection reduces the number of lanes crossed by pedestrians compared to a conventional intersection with multiple left- and/or right-turn lanes. At the secondary T-intersections, crosswalks are typically only needed at two locations to cross the either intersecting roadway. The pedestrian crossing should be placed only on the far side of the intersection (furthest from the main intersection) where pedestrians are only in conflict with right-turning vehicles from the quadrant roadway approach. Recommended pedestrian crossing locations at the main and secondary T-intersections are presented in figure 97.

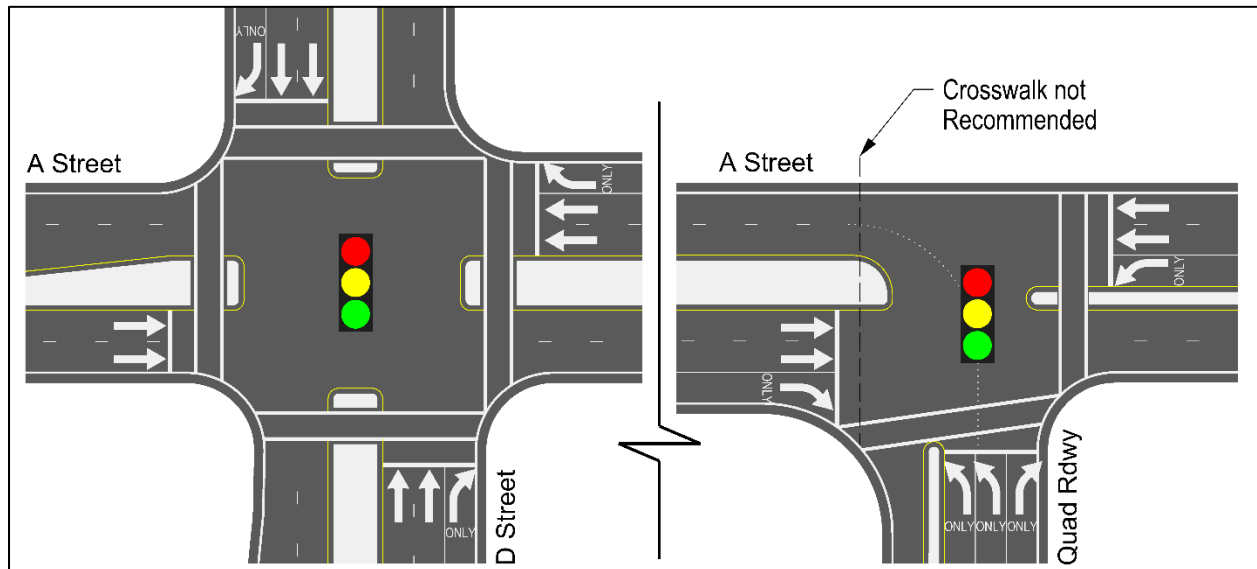

© NCDOT

Figure 97. Graphic. Pedestrian crosswalk placements.

Main Intersection Turn Prohibitions

At the main intersection, there are no physical barriers to vehicles making prohibited left or U-turns. Therefore, geometric design and proper signing and marking are important to eliminating or minimizing violations. One design strategy to deter prohibited turns is to construct raised medians on all intersection approaches where left-turn lanes would otherwise be provided. The raised medians deny potential left- or U-turning vehicles any refuge for making prohibited movements. The raised medians also provide a visible location for the posting of signs prohibiting left- and U-turn movements right at the main intersection. The median widths, offsets, and curb types should be designed to governing State or local standards and should not introduce an additional safety hazard at the intersection.

ROW Requirements

Due to the typical lack of need for dual left-turn lanes on either intersecting roadway, the QR intersection requires less ROW compared to a conventional intersection with dual left-turn lanes. Frontage along both intersecting roadways can also have higher costs and face greater limitations in the vicinity of the main intersection, where land costs are typically at a premium. QR intersections can also reduce ROW further at the main intersection by narrowing the approach median width from the secondary T-intersection through the main intersection. Where an existing roadway cannot be repurposed to a quadrant roadway, additional ROW is needed to construct a new quadrant roadway, and even greater ROW is needed to preserve the interior quadrant. The net ROW required for the QR intersection is typically more than a conventional intersection.

Medians

Raised medians along both roadways should be extended as close to the crossing street through lanes of travel as possible, with very small nose radii, to visually reinforce and make the left-turn movement geometrically difficult and non-intuitive. The crosswalk can be placed behind the nose of the median, and while two-stage pedestrian crossing is typically unnecessary and should not be encouraged, the median does reduce pedestrian exposure to vehicle travel lanes. This main intersection design guidance is illustrated in figure 98.

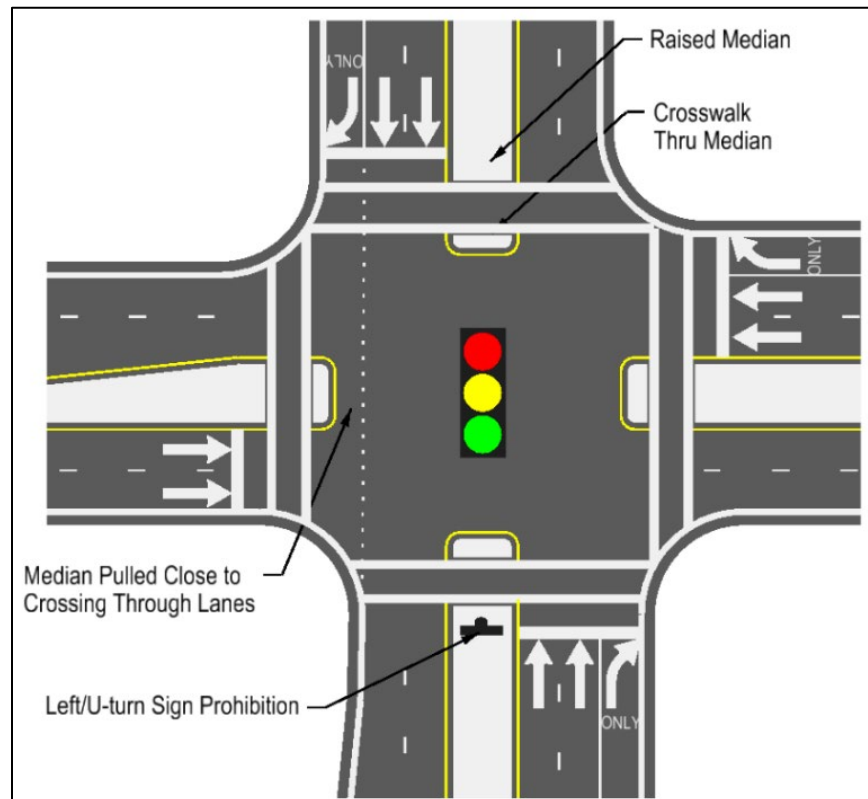

© NCDOT

Figure 98. Graphic. Main intersection design guidance.

Lesson Learned: Fairfield QR Intersection

The SR-4 / SR-4 Bypass quadrant roadway design removes all traditional left-turn movements from the major intersection, which initially proved challenging for motorists to understand and comply with. When the new intersection first opened, the City of Fairfield documented a large number of illegal turns. These illegal turns reduced significantly after the first week the intersection was open and decreased 90 percent within 8 months. However, after the project opening, many on the design team felt that the use of a physical barrier—such as a concrete median or landscaped island—and placing turn prohibition signs in those medians, would have been more effective in communicating the left-turn restrictions than simple transverse striping to prior left-turn lanes. These medians would have also fully restricted left turns to the development between the main and the secondary T-intersections instead of relying on regulatory signs as illustrated in figure 99.



© NCDOT

Figure 99. Graphic. Fairfield median lessons learned.

Design Vehicles

All movements at a QR intersection can and should be designed to accommodate the design vehicles on the intersecting roads, which are typically trucks and large vehicles, up to WB-67 vehicles. If the QR intersection is located along an OSOW vehicle route, the medians at the secondary T-intersections should be designed to accommodate the additional turning width requirements, and single-lane portions of the quadrant roadway would need to be sufficiently wide to accommodate OSOW vehicle turning movements, potentially using mountable and/or traversable curbs.

CHAPTER 8 — SIGNAL, MARKING, SIGNS, AND LIGHTING CONSIDERATIONS

This chapter discusses signal, signing, marking, and lighting design criteria and best practices for constructing and operating QR intersections. The guidance in this chapter supplements the national resources on intersection design highlighted in previous chapters, including the MUTCD and local agency design criteria and policies.⁽¹⁰⁾

DESIGN PRINCIPLES AND APPROACH

Traffic signal design, signing, pavement marking, and lighting design at a QR intersection can be different from a conventional intersection, particularly related to the left-turn prohibitions at the main intersection. The following treatments need to be emphasized at QR intersections:

- Provide signage and pavement markings to indicate the prohibition of left turns.
- Provide signage and pavement markings to establish wayfinding for right- and left-turn movements through all QR intersections.
- Provide a means for direct or indirect bicycle left turns.
- Provide appropriate lighting at conflict points (i.e., both main and secondary T-intersection crossings) to emphasize the presence of various users.

SIGNALS

Chapter 5 provides operational characteristics for potential signal phasing, cycle length, timing, and progression. At QR intersections, the main intersection is always signalized and, in most cases, both secondary T-intersections are signalized as well. This chapter provides guidance for planning and design of QR intersection signals.

Signal Equipment Locations

The placement of signal poles and signal heads for the main intersection of a QR intersection follow the same criteria as signals at conventional intersections except that no left-turn signals are provided at the main intersection. The location of signal poles and signal heads at the main and secondary T-intersections follow the same MUTCD guidance or State signal design standards as with a conventional intersection. At new QR intersections, pedestrian accommodations should be considered at all three intersections and should include pedestrian signals and accessible pedestrian signals/pushbuttons for all marked pedestrian crossing at all three intersections.

MUTCD standards call for signal heads to be placed no less than 40 ft beyond the stop bar, and no more than 180 ft, unless a supplemental nearside signal is provided. Because QR intersections are generally narrower compared to conventional intersections, supplemental near side signal heads are not typically required. Also, mast arm lengths are typically reduced because they do not have to hang left-turn signals over outside left-turn lanes as typical at conventional intersections. Most States and/or municipalities have their own standards for number and locations of signal heads for standard three- and four-leg intersections, and there are no special signal head placement requirements for a QR intersection that would override those governing standards. Whether wood poles, metal strain poles, or mast arms are used, all poles at all intersections should be located comfortably behind the curb lines and/or sidewalks where they are shielded from travel lanes. Figure 100 illustrates an example of typical mast arm signal pole placements at QR main and secondary T-intersections.

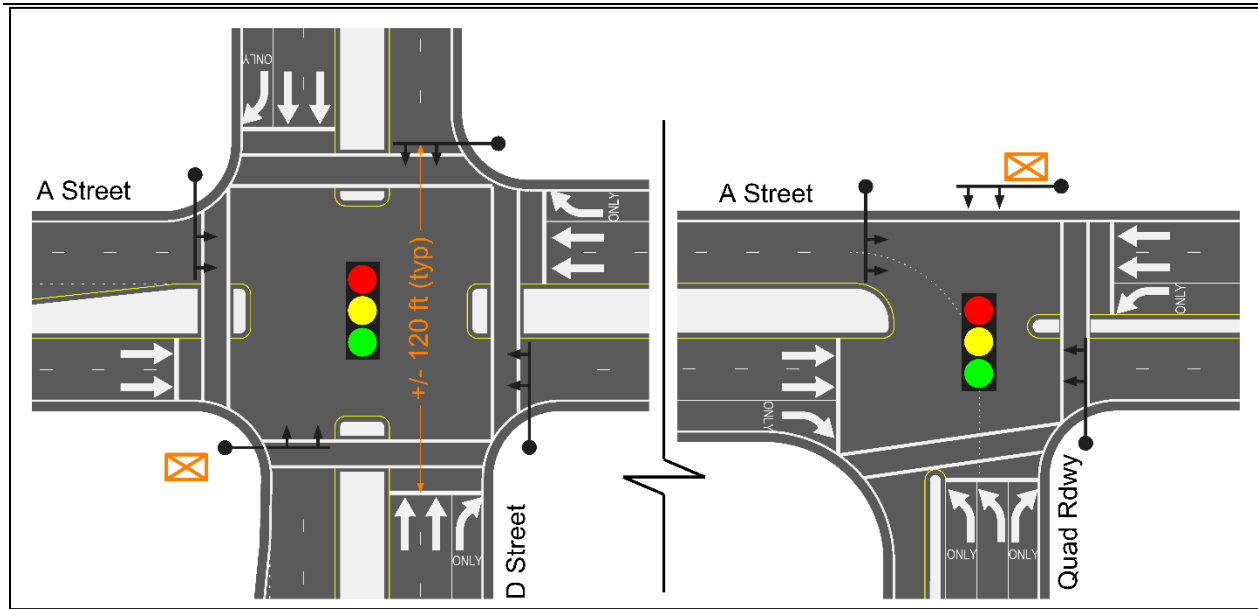

© NCDOT

Figure 100. Graphic. Typical mast arm pole, signal head, and cabinet placement.

As there are three signal cabinets at QR intersections, it is important that they be placed in a location so as not to obstruct vehicle sight distances. At the main intersection, decisions for signal cabinet placement are the same faced at a conventional intersection. At the secondary T-intersections, the logical placement is at the top of the T, where they are both out of the way of any vehicle lines of sight and reinforce that a fourth intersection leg is not desirable at any point in the future. When determining optimal signal cabinet placement, consider that a signal technician should be able to see all signal heads when working in the cabinet.

Controllers

QR intersections include three signalized intersections operating as a system. In many cases, the signal controller technology will allow each intersection to be operated with a single controller, although a multiple controller strategy can be implemented as well. Use of a single controller can be accomplished by programming the controller with more than the typical two-ring cycle, maximizing the flexibility in timing each intersection. Table 26 lists advantages and disadvantages of each control strategy.

A third alternative is to include a cabinet and controller at each intersection but link intersections with one controller operating as a “master” and the others as “slaves”. Each controller could work on its own, even in coordination, but linking outputs to inputs (using various parameters and logic) would allow further refinement of control, mimicking closely what a single controller can do. These linkages could be accomplished with hardwire connections or through peer-to-peer links on an Ethernet network. This approach might offer a “best of both” result.

Table 26. Considerations for one versus three controllers at a QR intersection.

Criteria	Single Controller Advantages	Single Controller Disadvantages	Multiple Controllers Advantages	Multiple Controllers Disadvantages
Cost	Fewer components to purchase and maintain	Greater need for wiring between intersections	-	Additional hardware and installation cost
Power	No communication set-up between controllers	-	Phases/timings simpler to program and maintain	-
Communications	Improved flow during free-run signal operations	-	If a controller fails, other intersections still function	Need for all controllers to communicate
Wiring	Single power service point	Long wire runs; cuts, voltage drops likely	Only conductor/detector wire runs to controller	-
Installation	-	Techs can't view all signals from 1 cabinet	Each cabinet visible to signal heads it controls	-
Operations	Fewer components to fail	More difficult signal design/cabinet set-up	Can better control offsets	Could have undesirable gap outs w/low volumes

Note: - signifies no information.

Signal Warrants

At appropriate locations for a QR intersection, the main intersection should meet MUTCD warrants for signalization. Secondary T-intersection volumes are comprised of displaced left-turn volumes that may or may not meet the same MUTCD signal warrants. If signalization of the secondary T-intersection is judged necessary to provide safe and efficient flow for indirect left-turn movements, the secondary T-intersection should not be required to independently meet signal warrants. This view of the secondary T-intersections being integral to overall intersection operational efficiency is not dissimilar DLT or RCUT intersections that have not historically required independent signal warrants at left-turn crossover or downstream U-turn intersections, respectively. Further, signalization of the secondary T-intersections can be operated in a coordinated signal phasing pattern that better serves left-turn movements without negatively impacting operational efficiency of the main through roadways.

Pedestrian Signals

Pedestrian signal placement at QR intersections is very similar to placements at conventional four-leg or T-intersections. The only difference is the lack of pedestrian crossing one of the approaches at the secondary T-intersection. All pedestrian signals should be pedestrian-actuated, with pushbuttons mounted on the signal poles or, if not convenient, on a separate pedestal.

Bicycle Signals

Bicyclists making direct left turns by using bicycle boxes or the crosswalks of a shared-use path can be controlled with bicycle signals displaying green, yellow, and red bicycle indications.

These signals could assist bicyclists who are unfamiliar with the intended bicycle travel pattern at a QR intersection.

Signal Coordination

The three traffic signals in a QR intersection should be interconnected by fiber if possible. On major roadways in urban and suburban areas, it is possible that both QR intersection roadways would already have fiber interconnectivity and the new or modified signals at the secondary T-intersections can be interconnected. If one or both of the secondary signals need connectivity to the main intersection, fiber runs(s) may be required as part of the QR intersection project. One possibility to avoid new fiber runs is to connect signals using controllers with GPS clocks.

High Left-Turn Demand

If one of the left-turn movements has a high-demand volume compared to the other left-turn movements at the intersection, consideration should be given to setting the signal offsets and cycle length to better facilitate the high demand. The offsets and overall cycle lengths may be adjusted such that the left-turn demand entering the quadrant roadway follows the path of the quadrant roadway and arrives at the opposite end of the quadrant roadway right as the right- or left-turn phase turns green. This eliminates any start-up/lost time and queue storage needs for the left-turning vehicles. Determination of the cycle length and offsets based on travel speeds and intersection geometry would be best analyzed using microsimulation tools.

Detection

Figure 101 illustrates potential detector placements at a QR intersection. Vehicle, bicycle, and pedestrian detection can be implemented similar to a conventional intersection to “call-off” phases having extra green time and giving the excess time to other phases for additional green time. This technique is relatively simple in a QR intersection since there are only two phases (at the main intersection) or three phases (at the secondary T-intersection) that need to be adjusted compared to a multi-phase signal at a conventional intersection. This technique can be particularly effective in off-peak times by providing more efficient green time to the rerouted left turns, mitigating the longer travel path.

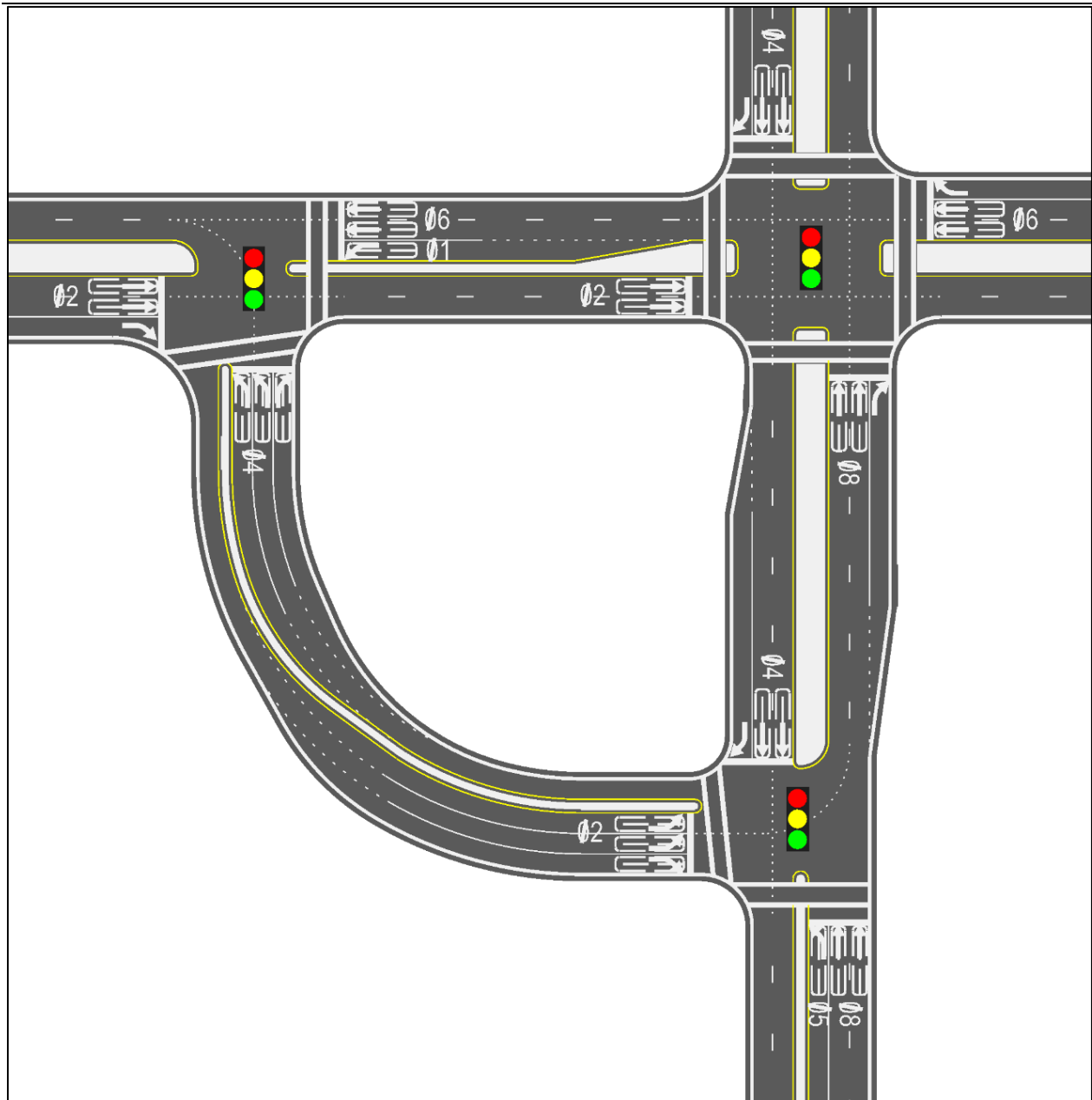

© NCDOT

Figure 101. Graphic. Detector placements.

Permissive Left-Turn Phasing

To reduce queue storage requirements on A and D Streets upstream of the secondary T-intersections, signal operators may consider protective/permitted signal phasing for leading left turns and permitted/protected signal phasing for lagging left turns. The protected left-turn movement should overlap with right turns from the quadrant roadway. Analysis of intersection sight distance and crossing through/left-turn demands should be conducted to ensure there is no degradation in intersection safety anticipated by allowing permissive left-turn movements.

SIGNING

Signing for QR intersections follows the same industry practice and MUTCD guidelines for vehicles, pedestrians, and bicyclists as for conventional intersections. In addition, QR intersection signing needs to provide motorists wayfinding at appropriate locations along all turning-movement paths through the QR intersection. Since QR intersections tend to be placed in urban areas, consideration for sign placement should be developed early in the life of the project to assist with ROW and utility constraints.

At a QR intersection, drivers may not expect the direct left- and U-turn prohibitions at the main intersection. Therefore, regulatory signing must be used to communicate these movements are prohibited. QR intersections require an alternate path for left turns that differ for each intersection approach. Therefore, signing in advance of the main intersection to guide left-turning vehicle paths is recommended. As indicated driver expectation is to be allowed to execute a left turn, advance signing should be required rather than recommended.

Regulatory Signs

The MUTCD does not provide explicit QR intersection signing concepts. However, States with QR intersections have used MUTCD regulatory signs supplemented with their State standards. Regulatory signs should be located where these signs would normally be placed at conventional intersections. Proper application of regulatory highway signs including “no left turn” (R3-2) and/or “no left turn/U-turn” (R3-18) aid in the guidance of movements through the QR intersection and identify prohibited movements as illegal. Figure 102 through figure 104 illustrate the use of these typical regulatory signs.

In addition to regulatory signs, ground mounted, and/or overhead guide signs are recommended to be placed at or near the intersection on one or both intersecting roadways to inform motorists of the required path for making left turns. Advance guide signs may be placed to inform motorists to:

- Move to the right or left lanes on A or D Streets.
- Make a right or left turn at the main intersection.
- Make a right or left turn at the secondary T-intersection.

Typically, a minimum of two guide signs on each approach are needed: an advance guide sign, and a second sign located at the main or secondary T-intersection confirming the message on the advance guide sign. While QR intersection signs and placements may be experimental from an agency perspective, the intent is to have them conform to the MUTCD with regard to color, letter size based on functional street type, amount of legend, type of destinations, and design of directional arrows. Guide signing should include route markings (cardinal direction, route number, and arrow guidance) where either intersecting roadway is a numbered route, or by making specific guide signs for streets that are not on numbered routes.

It is important not to “over-sign” a QR intersection. Sign clutter can have a detrimental effect on conveying messages and overall intersection safety performance. There is no need to identify the QR a special or unique intersection, nor need for special signs with unique messages or colors. Drivers should be guided using traditional guide signing wording and lettering common at conventional intersections and interchanges. Figure 105 illustrates part of a typical signing plan for a QR intersection at the juncture of two U.S. routes. Figure 106 illustrates a typical signing plan for a QR intersection at the juncture of a state route with local (municipal) street.



© NCDOT

Figure 102. Photo. QR intersection regulatory signing, Fairfield, Ohio.



© NCDOT

Figure 103. Photo. QR intersection regulatory signing, Front Royal, Virginia.



© NCDOT

Figure 104. Photo. QR intersection regulatory signing, Huntersville, North Carolina.

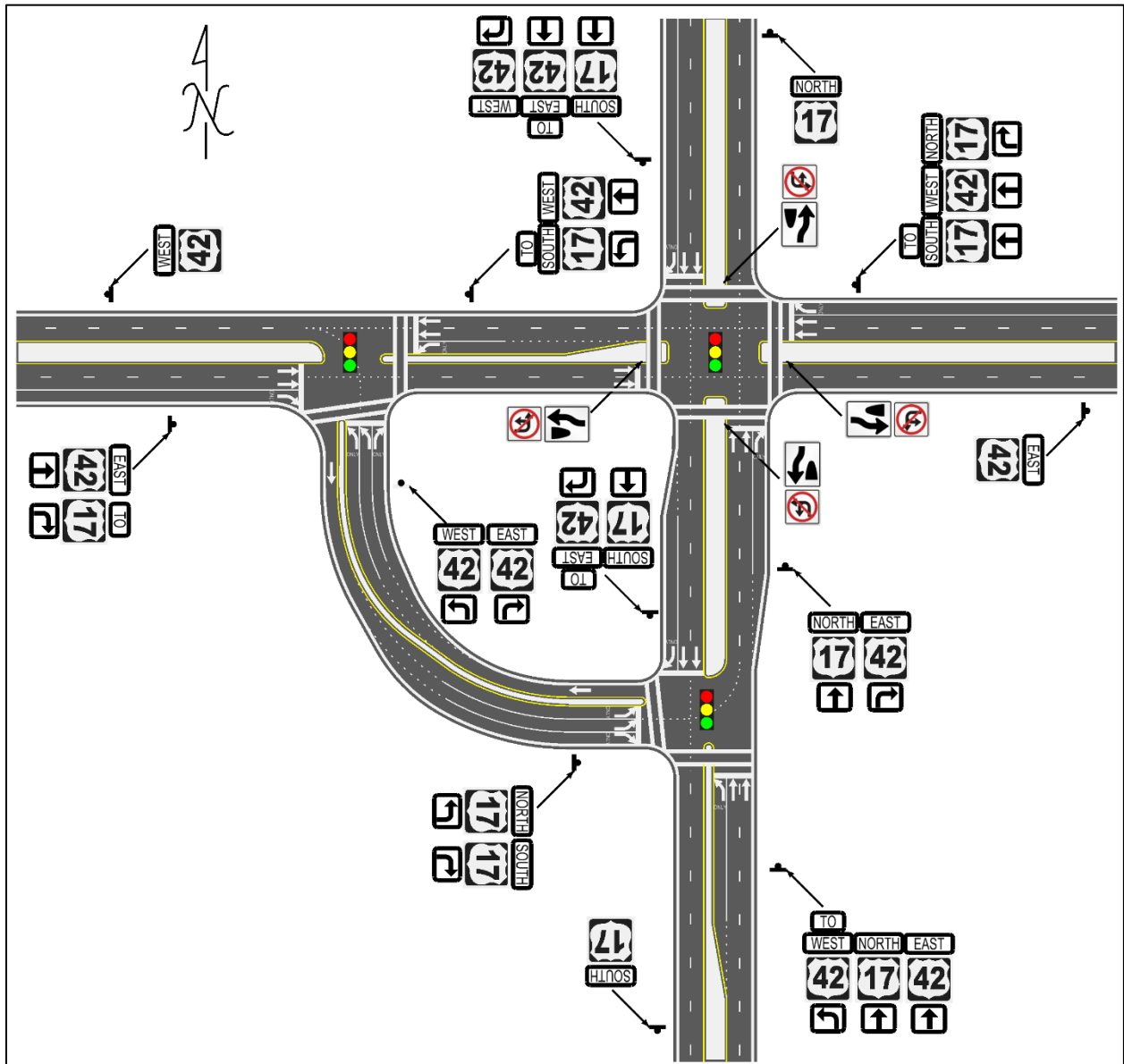

© NCDOT

Figure 105. Graphic. Typical QR intersection signing plan for juncture of two U.S. routes.

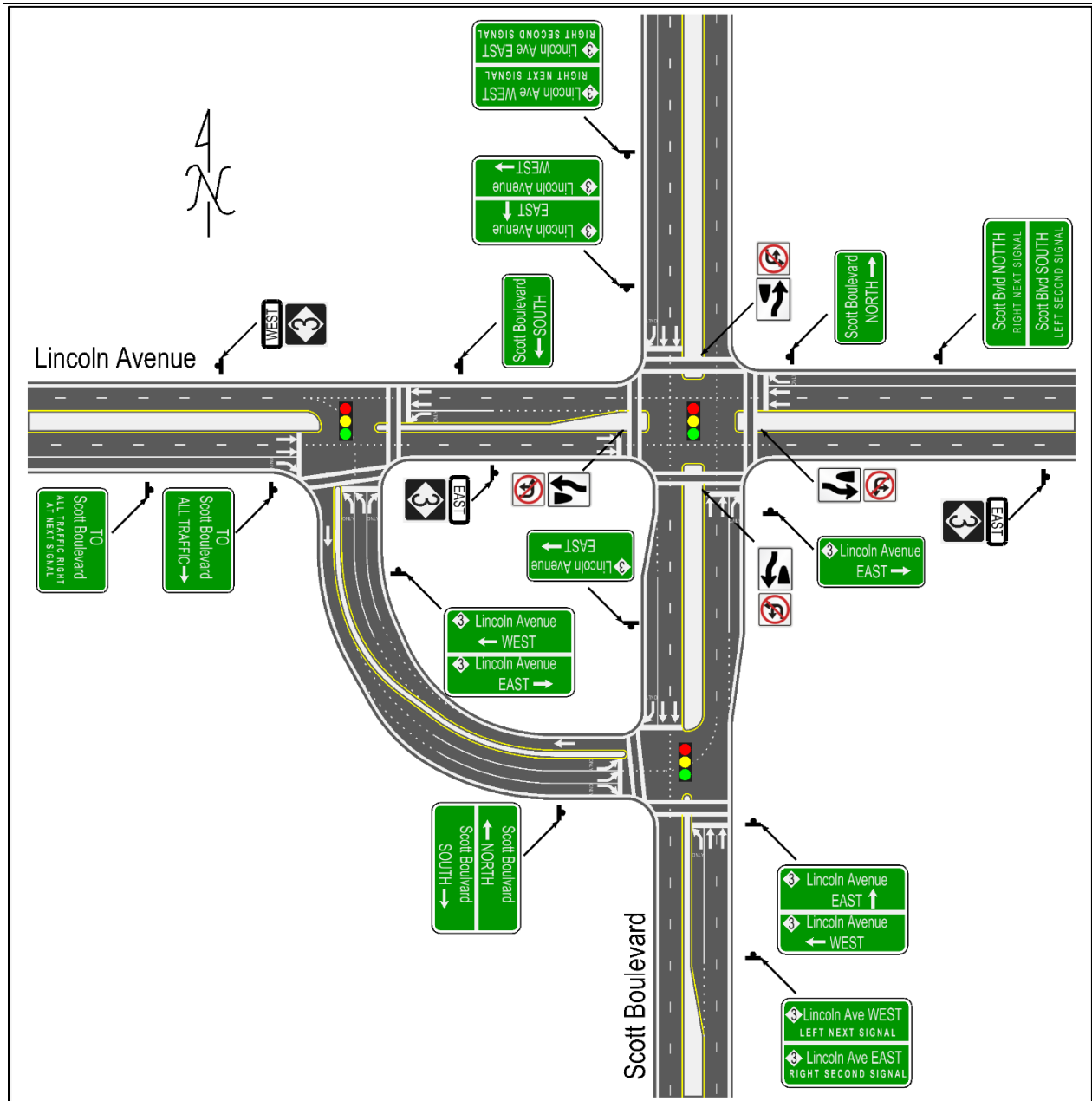

© NCDOT

Figure 106. Graphic. Typical QR intersection signing plan for juncture of State/local route.

Overhead and Special Signing

Motorists must be specially informed when they need to first turn right to make a left-turn movement. This is particularly important for motorists who may have to move from the left lane of the street to the right lane on multi-lane facilities. For these movements, the use of overhead signs is highly recommended. Sign placement is based on providing the motorist adequate time and distance to react to their message.

Figure 107 and figure 108 provides an example of the overhead guide sign placement and messages at the NC-73 / US-21 intersection. This location included additional overhead signing at the interstate off-ramp intersection upstream of the QR main intersection. Figure 109 through figure 111 include field photos of overhead signs placed at several different QR intersection locations.

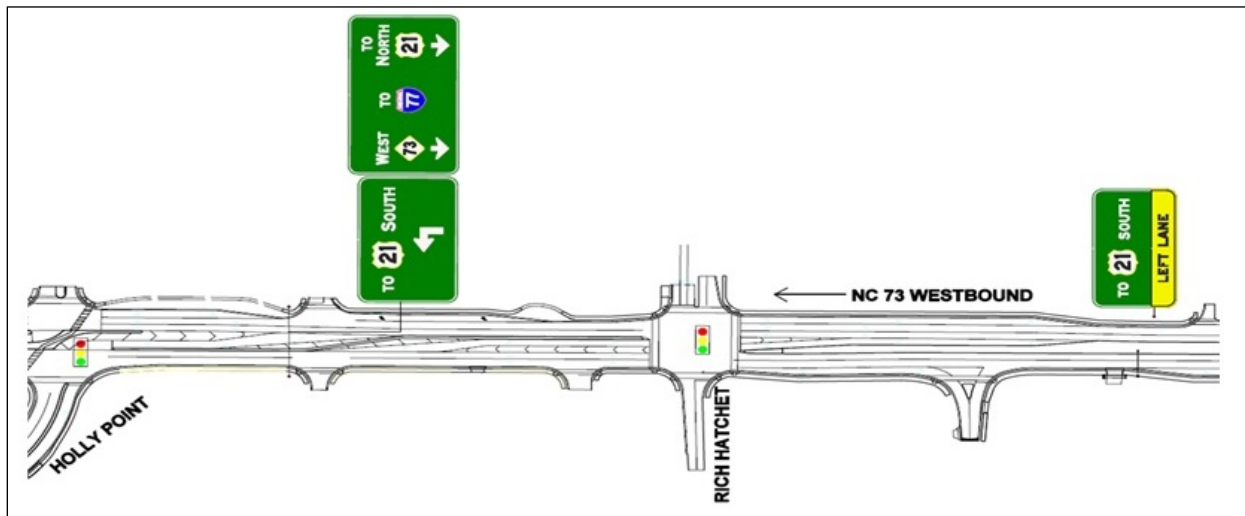

© Town of Huntersville, NC

Figure 107. Graphic. QR intersection overhead signing plan for westbound NC-73.



© Town of Huntersville, NC

Figure 108. Graphic. QR intersection overhead signing plan for eastbound NC-73.



© NCDOT

Figure 109. Photo. Examples of QR overhead signing, Hunstersville, North Carolina.



© NCDOT

Figure 110. Photo. Examples of QR overhead signing, Front Royal, Virginia.



© NCDOT

Figure 111. Photo. Examples of QR overhead signing, Fairfield, Ohio.

Wayfinding Signing on Quadrant Roadway

Many motorists may be initially unfamiliar with QR intersection operations, particularly left-turn vehicles that must leave either roadway and travel on the quadrant roadway. Wayfinding signs are important to reinforce route patterns and pull motorists through the quadrant roadway. There may also be the case where hospital, evacuation routes, or other routes of significance turn left at the QR intersection and thus should be incorporated into the QR intersection signing plan. In cases where the QR is located close to an interstate that include services signs, additional guidance signs may be used to guide motorists through the QR intersection to services identified on the interstate, as is the case at the Huntersville QR intersection. Figure 112 illustrates wayfinding signs on the quadrant roadway at the Front Royal intersection, and figure 113 illustrates services guide signs on the Huntersville intersection, where one of the QR intersection movements serves traffic exiting I-77 immediately west of the QR intersection.



© NCDOT

Figure 112. Photo. Route wayfinding signs on Front Royal quadrant roadway.



© NCDOT

Figure 113. Photo. Services wayfinding signs on Huntersville quadrant roadway.

Pedestrian / Bicycle Signing

Recommended QR intersection signing and supplemental pavement markings for pedestrian and bicycle accommodations should follow MUTCD standards and/or local signing standards. There are no special requirements for pedestrian crossings at QR intersections and no QR intersections constructed to date uses bicycle queue boxes. Figure 114 illustrates the MUTCD standard bike box sign (D11-20a) that could be utilized at future QR intersections.

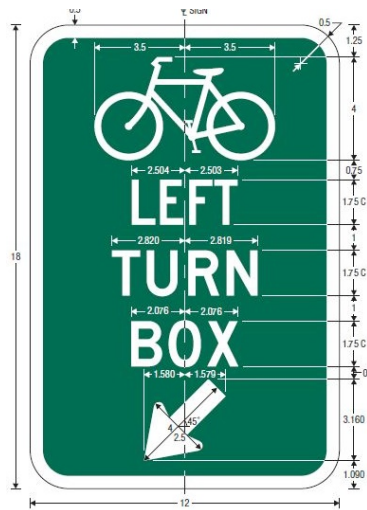

Source: FHWA

Figure 114. Graphic. MUTCD signing for left-turn bike boxes.⁽¹⁰⁾

Figure 115 shows bike box illustrative signing developed for a local bike lane project in Seattle, Washington.⁽³⁴⁾ It must be noted that it does not conform to the current MUTCD.



© City of Seattle, WA

Figure 115. Photo. Local example of bike box signing.

PAVEMENT MARKING

The MUTCD does not provide guidance for pavement markings specifically for QR intersections. Pavement markings for the main intersection of a QR intersection generally follow the same principles for those at conventional intersections (with or without medians), including edge lines, lane lines, pavement arrows, and crosswalks for pedestrian and bicycle accommodations.

In addition to traditional pavement markings, in-pavement lane guidance shields are used at each of the QR intersections constructed to date. Figure 116 and figure 117 illustrate lane marking shields to aid vehicle lane alignment and route guidance through QR intersections.



© NCDOT

Figure 116. Photo. Directional shield pavement marking, Huntersville, North Carolina.



© NCDOT

Figure 117. Photo. Directional shield pavement marking, Front Royal, Ohio.

CHAPTER 9 — CONSTRUCTION AND MAINTENANCE

QR intersection construction typically follows a sequence that might be similar as conventional intersections, with the overall goal to maintain non-motorized and motorized traffic during construction while providing a safe work environment. The context of the project location will inform the staging and sequencing of construction.

QR intersection construction costs may be higher compared to conventional intersections given the number and extent of intersection improvements and the need for increased traffic control devices. This is true for both new quadrant roadway construction and for retrofit situations where an existing roadway is repurposed to perform the quadrant roadway function.

The guidance in this chapter supplements the national resources on construction and maintenance, including the MUTCD and local agency design standards and policies. There is limited history in building QR intersections, but several different types and methods have been used to give examples of lessons learned during construction and/or maintenance. In the case that a new quadrant roadway is constructed, maintenance of traffic may be advantaged as the new roadway can be used to divert traffic around the main intersection, and present fewer constraints for lane additions, temporary construction activities at the main intersection, and provides a much larger staging area than at conventional intersection improvement projects.

CONSTRUCTION

North Carolina, Ohio, and Virginia have constructed QR intersections in recent years. These State transportation agencies could serve as resources for construction and maintenance guidance. As with any new type of street construction, additional communication, and coordination with construction contractors may streamline project implementation. Understanding lessons learned from agencies having developed QR intersections may reduce construction delays.

One of the benefits of constructing QR intersections, versus other alternative intersections, is their ability to be constructed relatively easily when being converted from a conventional intersection. This is especially true when the quadrant roadway is new construction. Conversion includes removing existing left-turn lanes from the conventional intersection and installing raised medians at the main intersection, and construction of two new secondary T-intersections. Unlike other alternative intersections and interchanges that transpose traffic streams (such as DDIs and DLT intersections), there is no coordination needed in moving traffic movements from the right side of the street to the left side of the street.

Intersection and/or Corridor Widening

Developing new QR intersections, much like conventional intersections, may require additional lanes to be added at the following locations:

- At the secondary T-intersections.
- Along an existing roadway being repurposed to function as a quadrant roadway.
- On the far right for right-turn lanes.

Unlike a conventional intersection, which is primarily centered at the intersection of the two crossroads, QR intersections extend approximately one-eighth of a mile in two directions from the main intersection and include a new or repurposed quadrant roadway. Depending on the width of the existing ROW and where additional lanes are required, it may be more favorable to:

- Widen symmetrically on both sides of the street.
- Perform all widening exclusively on one side.
- Use the quadrant roadway to maintain traffic.

Each widening approach might be considered depending on project specific features. Decisions on each widening approach will primarily depend on the geometric design, project cost, maintenance of traffic plan, and overall impact to adjacent land owners and the community, particularly when ROW must be purchased.

Construction Staging

The sequencing of construction phases for a QR intersection depends on the number of lanes, the width and ROW of crossing roadways, and the extent of construction needed for the quadrant roadway. While there are numerous variations to consider, two primary variations are provided below:

1. Sequential construction:

- Construct quadrant roadway (if new) or reconstruct existing roadway to serve as the quadrant roadway.
- Improve geometries at secondary T-intersections and install permanent signals.
- Improve both intersecting roadways, using quadrant roadway (when necessary) to detour traffic when making critical improvements on either roadway.
- Open all QR intersections to traffic when all movements are open (no partial openings).

2. Simultaneous construction:

- Construct improvements along both intersecting roadways including all medians, pavement, drainage, bike lanes, sidewalk, and/or other multimodal features.
- At the same time, construct quadrant roadway (if new) or reconstruct existing roadway to serve as quadrant.
- Detour left-turning traffic onto the quadrant roadway (permanently) and close left turns at the main intersection.
- Finalize improvements at the main intersection and open all QR intersections.

In using either of these construction staging plans, it is not recommended to open the QR intersection in phases; that is to open any of the indirect left-turn movements to traffic before other left-turn movements. Drivers must acclimate to the new left-turn patterns of the QR intersection and doing so more than once may confuse and frustrate motorists despite the best intended temporary traffic control measures.⁽³⁴⁾ This was one of the lessons learned at the Fairfield, OH implementation as detailed in *Intersection Profile 1* in Appendix A.

COSTS

The cost of converting a conventional intersection to a QR intersection varies depending on the specific project context. The general considerations and elements affecting costs of a QR intersection are similar to those at a conventional form. It may include the following considerations:

- Amount of additional ROW required for the new or repurposed quadrant roadway.
- Number and length of additional roadway lanes required.
- Area of new pavement and sidewalks.
- New and/or upgraded signalization and modifications to existing signal system.
- Utility impacts including relocations, increased lighting, and/or new signal interconnect.
- Number of overhead signs and sign structures.
- Access modifications.

Total project costs associated with developing a new QR intersection may vary greatly depending on project and community specifics, including ROW acquisition costs, displacements, public outreach, and contractor bidding. Typically, the most variant cost factor is ROW, which may or may not be a project requirement and can vary greatly by geographical location and density of adjacent land uses.

While the cost to implement a QR intersection is likely greater than the cost to construct a conventional intersection at the same project site, QR intersections are considerably less expensive than grade-separation alternatives and are likely compatible to other alternative intersection forms. Historically, QR intersection construction costs have been difficult to isolate, as projects to date have been part of a larger corridor projects and a significant bridge project.

Table 27 presents cost estimates developed from the four most recent QR intersection installations including the total project cost (if the QR was built within a larger construction project) and the actual (or best estimated) cost of the QR intersection.

Table 27. Summary of costs associated with QR intersections.

Location	Project Description	Open to Traffic	Project / (QR) Costs
SR-4 at SR-4 Bypass - Fairfield, Ohio	First, full QR to open in U.S.; part of larger project on SR-4 that included superstreet intersections; only QR intersection could equitably serve traffic on both roads	January 2012	\$28 M (\$2.3 M)
US-21 at NC-73 - Huntersville, North Carolina	QR Intersection part of a larger corridor project that included superstreet intersections; first QR that repurposed an existing street (Holly Point Drive)	March 2012	\$25 M (\$1.8 M)
US-340/522 at SR-55 - Front Royal, Virginia	QR built as part of major bridge replacement project spanning the Shenandoah River in western VA; was built to serve traffic “for the lifespan of the bridge”	December 2017	\$49.5 M (\$2.5 M)
US-42 at KY-872 - Florence, Kentucky	This stand-alone quadrant roadway intersection improvement became the fourth pure QR intersection in the U.S. and the first in Kentucky	August 2019	(\$3.2 M)

MAINTENANCE

Maintenance requirements at a QR intersection are similar to a conventional intersection. For maintenance of through lanes at the main intersection, lane closure will have reduced impacts as there is no adjacent left-turn lane, so there is less chance of vehicles traveling on both sides of the work zone simultaneously. Maintenance at the secondary T-intersections would be identical to that of any conventional T-intersection.

There are additional traffic signals and equipment, ground-mounted and overhead signs, and pavement marking and potentially in-pavement guide markings to maintain throughout the life of the project. There are no additional challenges to performing routine or resurfacing maintenance, and typical processes follow the appropriate work zone guidelines as for all conventional intersections. However, there are also fewer signal heads and less lane detection to maintain at the main intersection. Like other conventional roadways, conducting maintenance activities during off-peak times can minimize traffic disruptions.

In some cases, QR intersections provide the advantage of being able to locate utility vehicles within center medians to work on overhead signal, signs, and/or lighting fixtures, where utility vehicles at conventional intersections may have to block travel lanes or locate on private property to perform maintenance functions.

Snow Removal

Snow removal for a QR intersection is accomplished similar to a conventional intersection. Through lanes are plowed as part of the corridor, and snow is systematically pushed to the outside of the street. The quadrant roadway must be maintained to the same standard as the intersecting roadways for the intersection to function. Snow is pushed through the U-turn to the opposite side of the street.

Work Zone Traffic Control

Part 6 of the MUTCD provides guidance regarding signing and marking needs during construction and temporary street and intersection configurations.⁽¹⁰⁾ MUTCD principles and

applications for conventional intersections and streets would apply to constructing a QR intersection.

Depending on the construction phasing and sequences, the work zone traffic control includes the following types of regulatory information:

- Signalization, signing, and pavement markings to inform motorists traveling through the construction zone when they have the right-of-way and appropriate lane assignment.
- Guidance information to inform unfamiliar motorists in making decisions whether to turn right, left, or continue through the intersection.
- Guidance information to inform motorists of changes in the operation (e.g., lane changes) of the intersection due to construction activities.

While there are numerous variations in constructing QR intersections, the regulatory, guidance, and construction-related functions must be provided throughout the construction phases and in accordance with MUTCD.

Lesson Learned: Front Royal QR

A portion of SR-55 (West Strasburg Road) west of Route 340/522 (North Shenandoah Avenue) was closed for several weeks in October 2017, just prior to the final completion of the project. The temporary “detour” using the quadrant roadway (illustrated in the graphic to the right) allowed contractors to reconstruct the portion of SR-55 within the new QR intersection. The detour limited the need for temporary pavement construction and reduced the intersection construction schedule. Traffic was rerouted as follows:

- Drivers heading east on SR-55 from Strasburg turned right onto the quadrant roadway, which led to the new traffic signal at SR-55 / US-340/522.
- Drivers then turned right on East Strasburg Road to reach Front Royal or left to reach I-66.
- Drivers on SR-55 wanting to reach Strasburg passed through the main intersection, turned right onto the quadrant roadway at the new traffic signal and then turned left onto SR-55.

Intentionally sequencing construction to close Route 55 between the quadrant roadway and Route 340/522 for reconstruction went a long way to help acclimate motorists to using the quadrant roadway before the full opening. Prior to and during the construction “detour” implementation, the project public involvement teams conducted critical outreach efforts, which were vital to enhancing the public's understanding of the QR intersection's function. Traffic delays due to the temporary six-week closure were disruptive to motorists, so everyone was extremely glad to see the construction end and all lanes accessible.



© Virginia Department of Transportation.

Figure 118. Graphic. Front Royal construction maintenance of traffic lessons learned. Provided by Virginia Department of Transportation.

LAW ENFORCEMENT

Initially, there may be additional law enforcement needs for a constructed QR intersection. Upon project opening, there is nothing to physically prohibit direct left turns at the main intersection. Enforcement during the period after the QR intersection is opened to traffic has been effective in helping drivers become familiar with intended operations and reducing illegal maneuvers. As the novelty effect of the new intersection operations subside, the need for extra enforcement will diminish.

APPENDIX A – CATALOG OF KNOWN INSTALLATIONS IN THE U.S.

Appendix A includes information on all know full, partial, or hybrid QR intersections currently operational in the U.S. Table 28 presents project information and locations of all known full or partial QR intersections constructed in the U.S. Additional information is presented for several QR intersection designs, presented in intersection profiles in this Appendix.

Table 28. Full, partial, and hybrid QR intersections in the U.S.

Intersection	City, State (Type)	Description	Year Open	Location Coordinates
US-42 at KY-872 (Hopeful Church)	Florence KY (Full)	Fourth QR intersection in U.S.; Includes a new 3-lane quadrant roadway with a mid-point access to parcels adjacent/inscribed by quadrant roadway	August 2019	38°58'40.08"N 84°39'26.49"W
Market St. at Kerr Avenue	Wilmington NC (2-quad)	Repurposed one roadway and built new roadway in opposite quadrant to create a dual-quadrant intersection; currently removes two of four lefts	August 2018	34°14'52.55"N 77°51'49.57"W
US-340/522 at SR-55	Front Royal VA (Full)	Part of \$49M bridge project, QR built at terminal of new signature bridge over Shenandoah River; QR built to serve traffic “thru lifespan of bridge”	December 2017	38°56'48.14" N 78°11'58.20" W
NC-73 at US-21 (Statesville Road)	Huntersville NC (Partial)	QR part of a larger superstreet project on NC-73; first QR that repurposed an existing street (Holly Point Drive) and serve inscribed development	March 2012	35°26'32.42" N 80°51'55.23" W
SR-4 (Ross Rd) at SR-4 Bypass (Dixie Hwy)	Fairfield OH (Full)	First full QR in U.S.; part of a larger superstreet project on SR-4. SR-4 / SR-4 Bypass intersection had highest & balanced intersection volumes and superstreet would not work at this intersection	January 2012	39°19'26.16" N 84°30'16.50" W
SR-527 at SR-96	Mill Creek WA (Partial)	At this skewed intersection, one left-turn movement is removed from the main intersection, via 16th Avenue SE	2004	47°52'42.16" N 122°12'25.16" W
US 97 (Bend Parkway) at Powers Road	Bend OR (2-quad)	At this 2-quad intersection, both secondary T-intersections on minor street are unsignalized; major street is served by RIRO access points	2001	44°01'43.62" N 121°18'56.01" W
US-220 at Church Street	Greensboro NC (Partial)	Left turns prohibited on 3 of 4 intersection approaches; SB left uses Cherry Street in SW quadrant; other two use City streets elsewhere	1977	36°05'15.75" N 79°47'02.98" W
Telegraph Rd (US-24) at 15-Mile Road	Bloomfield Hills MI (Hybrid)	Hybrid QR intersection combined with a Median U-turn crossover. Main intersection restricts all left turns, but only two left turn use QR (other two use median crossovers on Telegraph Road)	Mid 70's	42°32'42.50" N 83°17'00.16" W
Van Dyke at Chicago Road & 14 Mile Rd	Warren MI (Partial)	Partial QR intersections with unsignalized T-intersections along corridor; quadrant roadways in one quadrant “cut the corner” to remove direct left turns from Van Dyke Avenue	Mid 70's	42°31'26.41" N 83°01'43.65" W 42°32'12.95" N 83°01'42.49" W
SR 55 at Empire Street	Bloomington IL (2-quad)	2-quad intersections in opposite quadrants; secondary T-intersections are signalized	1980's	40°29'17.04" N 88°57'07.62" W
Grand River Ave at MLK	Lansing MI (Partial)	Partial QR; left turns prohibited only on Grand River and redirected to use Logan Access Road	Mid 60's	42°45'34.07" N 84°33'59.23" W

INTERSECTION PROFILE 1: SR-4 AT SR-4 BYPASS, FAIRFIELD, OH

© ODOT

Figure 119. Photo. SR-4 at SR-4 Bypass, Fairfield, Ohio.

The City of Fairfield did not seek to be the first in the U.S. to implement a QR intersection, but as part of the SR-4 corridor improvement project, seen in figure 119, the QR intersection was found to be the best way to achieve acceptable levels of service and safety while considering the social, economic, and environmental costs of the improvement project. Although unique, it best met required criteria from project stakeholders including FHWA, the Ohio Department of Transportation (ODOT), the City of Fairfield, and the local community. The intersection improvement was not specifically developed as a QR intersection, as State and City engineers were not initially aware of the QR intersection concept, referring to the design as a “Diversion Road”. Once the QR intersection literature and materials were provided to the City, some of the public education materials were helpful closer to the project opening.

The SR-4 / SR-4 Bypass QR intersection included a new roadway in the northwest intersection quadrant where the land was owned by ODOT. The intersection of SR-4 and SR-4 Bypass had a history of long delays and congestion-related crashes, five times the statewide average. The QR intersection was projected to reduce crashes and enhance traffic flow to and from SR-4, which served 40,000 vehicles per day in 2010. There were initially 10 different conventional and alternative intersections studied as potential intersection improvements, and the QR intersection was shown to operate the best and have the least ROW and environmental impacts and was therefore selected as the preferred alternative and constructed.

The design included a maximum number of lanes on the quadrant (six total) to provide two receiving lanes and dual left and dual right-turn lanes at each end of the quadrant roadway. The main and secondary T-intersections are spaced within in the ideal recommended range of 500 and 550 ft. The design also included overhead signs on span wire and in-pavement markings on the quadrant roadways to assist with directional and lane assignments. Regulatory signing is used to prohibit left turns at the main intersection; however, there were no raised medians or other special signing or markings on either roadway approaching the QR intersection.

There was an appropriate level of public involvement conducted throughout the planning process, including a project website, continual meetings with business owners, and local paper

and TV media announcements, despite there being only a few businesses directly impacted by the QR intersection.

After Opening

In the weeks and months after opening, lessons learned were identified and published. In an article published in AWP Reporter in 2013, authors Mann and Hoying made the following observations about pre- and post-conditions of the first QR intersection:⁽³⁴⁾

- During construction, portions of the newly constructed quadrant roadway were opened before all lanes on the receiving roads were complete, leading to motorist confusion and frustration. Temporary message boards were added as the project opened to help reinforce the new turning patterns.
- In addition to problems created by the partial opening, driver habits and inattention created some challenges when the intersection opened, and many illegal left turns were being made. Through education and enforcement, the number of illegal left turns dropped by 90 percent after the first month.
- Left-turn restrictions should stand out through geometric design. Using a physical barrier, such as a concrete median or landscaped island, would have been more effective than adding transverse striping to previous left-turn lanes to communicate the left-turn restrictions.
- The project met triple bottom-line goals of economic, social, and environmental impacts. Neither SR-4 or SR-4 Bypass had to be widened, eliminating roadside wetland impacts. The project also used existing local resources, including a large amount of fill obtained from sites around the city. Economically, the QR intersection greatly reduced delay and had little economic impact on existing business revenues.

Crash data were collected and analyzed for the three years prior and the three years after the QR opened to evaluate safety performance of the QR intersection. Crashes at the main intersection and the SR-4 / Diversion Road T-intersection were reduced in number and severity compared to the prior conventional intersection. However, there were a significant number of crashes, many resulting in injuries, at the SR-4 Bypass / Diversion Road intersection, bringing the three-intersection total to be greater than the “before” condition of a singular conventional intersection. Further evaluation of the crash data showed the clear majority of the SR-4 Bypass / Diversion Road crashes were rear-end crashes (72 percent), and further engineering studies are on-going to determine if signal timing, driver confusion or other cause are the root of the high crash rate at this one secondary T-intersection.

The overall success of the project was widely acknowledged, leading to receipt of the *2012 Donald C. Schramm Transportation Improvement Award* from the southwest Ohio Chapter of the American Society of Highway Engineers.

INTERSECTION PROFILE 2: NC-73 AT US-21, HUNTERSVILLE, NC

© Town of Huntersville NC

Figure 120. Photo. NC-73 at US-21, Huntersville, North Carolina.

The intersection of US-21 and NC-73 in Huntersville, North Carolina is the meeting of two regionally significant corridors in the northern Charlotte region, as seen in figure 120. The intersection is in close proximity to I-77 and a high-level of service and retail development exists in the interchange area. The intersection was controlled by a complex 8-phase signal, and experienced frequent crashes, long delays and queues that often backed-up onto the interstate ramps.

In 2007, funding was appropriated to widen NC-73 and increase capacity at its intersection with US-21. During the planning process, a traditional widening concept was evaluated that would create dual left-turn lanes, dual through lanes and right-turn lanes on every intersection approach. However, a conventional intersection that maintained the 8-phase signal at the NC-73 / US-21 intersection in close-proximity to the I-77 ramp terminals would always be subject to current weaving and queuing issues and result in congestion reaching the interstate ramp terminals.

Alternative intersection improvement alternatives were also studied, including the QR intersection. Under the QR concept, the existing, underutilized Holly Point Drive, a public-maintained city street, was found suitable to function as the quadrant roadway. At the time, there were no exact examples of a QR in the U.S. in a built-upon urban environment; however, it conceptually solved major issues relating to intersection proximity, reduction in signal phases, and maintained critical access to local businesses. Under the QR concept (that widens NC-73), the 2030 peak hour total network delays were forecast to be reduced by 46 percent compared to the conventional intersection improvements.

Understanding the significant operational benefits that the QR would provide, State and local transportation officials and elected representatives recommended the QR intersection as the preferred improvement. Some area businesses owners and vocal members of the public expressed concerns about potential for negative impacts to businesses and the community. In response, Town and State officials made sure there was a robust public outreach and education process—both during and after project was complete. Multiple media releases and visualizations

were presented to local newspapers, television stations, and websites to convey the purpose of the project and the benefits of the QR. The initial public outcry included e-mails and phone calls to public officials proclaiming the QR intersection to be “the worst idea in history” and claimed the project would “destroy local businesses”. Public officials and transportation engineers worked to address access public concerns and stood firm in their belief the QR intersection was the best choice. In 2009, the NC-73 project (inclusive of the QR intersection) began construction and was completed in March of 2012 as the second QR open in the U.S.

The project deviated from a “pure” QR intersection in a couple of ways. First, the intersection operates as a partial QR intersection, as left turns are prohibited from NC-73 onto US-21 but are allowed from US-21 onto NC-73. Second, both secondary T-intersections include a fourth leg with full or partial access provisions. The fourth legs provide access to established regional businesses and there was no political will to relocate or remove these access points. To minimize the fourth-leg signal phasing impacts, the NC-73 / Holly Point intersection has directional crossovers to limit some movements, and the US-21 / Holly Point intersection is split-phased with no protected left-turn phases from US-21.

After the project opened, public comments took a more positive tone. Citizens responded with comments like: “The restriction of left turns makes no sense, but the intersection sure works 100 times better!” and, “Just wanted to express to the Town that after a couple of months of withholding judgment, I am convinced that the new traffic pattern has made a HUGE and positive difference in moving traffic through the intersection”. Most businesses embraced the project, as they did not experience a significant drop off in customers or revenues during construction or after the QR was in place. Motorists who once avoided the intersection due to routine congestion now find their way to the area for shopping and entertainment, understanding the extra travel distance for some movements translated into an overall timesaving.

Several travel-time runs concluded the signal system was timed appropriately and was well coordinated. Enforcement of the intersection turn prohibitions included citation of violating motorists (more initial but fewer over time) but many motorists were self-policing of drivers attempting to make the restricted left turn by blowing their horns to keep them moving. Even though a vigorous public outreach and education campaign was conducted, at first drivers were tentative and seemed to not trust the signage and pavement markings guiding them to turn in a direction different from what they had been accustomed to for many years. Area business owners were initially concerned about the new traffic pattern and change in access in-and-around the intersection. This was to be expected since patrons would not only have to navigate a new unconventional intersection, but also find new ways in and out of limited access driveways, some that had full access prior to the intersection improvement project.

In 2014, an analysis was performed by NCDOT to compare traffic operations with the QR intersection in place to how the intersection *would* have operated if the conventional improvements had been made. In 2014, the QR intersection operated at overall LOS C with all individual lane groups operating at LOS D or better and traffic queues did not extend to the interstate ramps. Calibrated analysis of the conventional intersection improvements showed operations would be near capacity, with multiple movements operating at LOS F and queues extending from US-21 onto the I-77 ramps. A crash analysis conducted in 2017 compared three years of crash data prior to construction to three years after the project opened. The data suggested that crashes adjusted by volume growth increased by nine percent, but the crash severity index increased by only one percent.

INTERSECTION PROFILE 3: US-340/522 AT SR-55, FRONT ROYAL, VA

© Virginia Department of Transportation

Figure 121. Photo. US-340/522 at SR-55, Front Royal, Virginia. Provided by Virginia Department of Transportation.

Located on the northern outskirts of the Town of Front Royal, Virginia’s first QR intersection was constructed at the intersection of US-340/522 at SR-55 as part of a major bridge replacement project. The 2,000-ft South Fork Bridge, spanning the Shenandoah River and the Norfolk and Southern Railroad needed replacement, as it was a low sufficiency-rated truss arch bridge similar to the I-35 Mississippi River Bridge that collapsed in Minneapolis in 2006. The intersection of US-340/522 at SR-55 is a few hundred feet from the end of the bridge abutment and VDOT wanted an intersection with a capacity that would maximize the life of the intersection and complement the longevity of the bridge design.

A primary goal of this project was to significantly reduce congestion and improve safety on US-340/522, a route that carries volumes equivalent to nearby I-66 (approximately 30,000 vpd). A regional Small Area Plan study showed that conventional improvements at the US-340/522 / SR-55 intersection would break down in 20 years, and VDOT wanted an intersection that would complement the longevity of the bridge design. Significant development was planned in this area, including a proposed Walmart in the northwest intersection quadrant. Design context was also important, as this route is a gateway into Shenandoah National Park and there are many historic elements in the area.

VDOT began to develop intersection alternatives with a dozen different concepts—including roundabouts, superstreets, and grade separation—that were tested using operational models. Grade-separated alternatives were dismissed as being too costly and having too great an impact on historic elements. An early favorite was a DLT intersection that moved left turns to/from SR-55 “out of the way”, reducing conflicts with US-340/522 through traffic, even though left turns experienced lesser operational benefits. However, there were concerns that adequate storage for the upstream left-turn lanes could not be provided without encroaching on the bridge abutment. When variations of the DLT intersection were conceptualized to resolve queuing requirements and work in the computer model, the configuration began resembling a QR intersection. Once recognized, the QR intersection alternative was added to study and functioned exceedingly well.

At the time the project began in 2008, this would have been the first QR intersection built in the U.S., and wanting to do full due diligence, VDOT referred to the FHWA QR Tech Brief and other publications for concept and design guidance and performed CAP-X and CORSIM analysis to validate traffic operations. Models showed the QR main intersection would function at LOS C and the secondary T-intersections at LOS A through the design year of 2040.

The intersection context also favored the QR intersection. SR-55 to the east, accessing the locally referred to “Riverton area”, is land-locked by the river and floodplains and will never heavily develop. The major movements would always be through traffic on US-340/522 and turns to/from SR-55 to the north to access I-66.

Prior to the QR concept development, a Walmart was proposed in the intersection quadrant the QR intersection was ultimately located in, but the development plan was rejected by the City. With no pending development plans, VDOT was able to purchase the entire quadrant. The purchase of the quadrant added approximately \$1M to the project cost (compared to conventional intersection improvements), but the project team viewed that as a bargain compared to the cost of grade separation. Further, any intersection improvement project would require maintenance of storm water on-site (stormwater credits could not be purchased) and the interior of the quadrant became a perfect fit for a stormwater management basin.

The protection of the secondary T-intersections was made easier by the fact that one of the secondary T-intersections was too close to the bridge abutment to construct a fourth leg. The other T-intersection on SR-55 was granted limited access by the Commonwealth. Limited access can be broken, but not without permission by the highest level of the State that would likely deny any such future request to maintain the integrity of the QR intersection. Subsequently, when a service station/convenience mart was proposed on the adjacent property, VDOT was able to tightly control access and protect the integrity of the QR intersection.

Signing plan development included an overhead sign structure on the bridge that focused on communicating directions (what the motorist SHOULD to) rather than on turn prohibitions (telling motorists what they should NOT do). Providing a clear and explicit sign plan was a concern of the design team throughout the development of the project. Later in the project, additional diagrammatic signs and pavement shields were added as the plans were finalized to provide additional wayfinding.

A public involvement plan was key to the success of the QR intersection, and the project public meetings required citizens entering the meeting to first watch a narrated and animated short video to explain the goals of the project, how the project alternatives were developed and shortlisted, and why the QR was the preferred alternative. The video included side-by-side comparison of QR and alternative intersection configurations and many project operations and safety MOEs. It also showed how some of the QR intersection turning movement patterns were not dissimilar to loop ramp movements at the US-340/522 / I-66 interchange, which resonated well with the citizens. After the public meetings, the public reaction was estimated at 70/30 in favor of the project with just a few vocal critics of the project. The project team coordinated with GPS/mapping companies in advance to have the revised traffic patterns reflected on opening day so turn-by-turn navigation instructions accurately guided motorists through the new intersection.

Once the project was opened, VDOT engineers were pleasantly surprised at how well people adapted to the QR intersection. There were the occasional violators and others who slowed or stopped at the intersection out of confusion, but that did not become a safety problem. One of the advantages at the project opening is that drivers were so used to varying traffic patterns employed during the work-in-progress construction phases—that included a final phase where everybody was forced to use the QR while a final section of US-340/522 was rebuilt—that the final product was no less intuitive to motorists and they just adapted without any significant level of enforcement. The result is that intersection queues are cleared every cycle, and business actually picked up customers because traffic flows improved. The project team received several complimentary e-mails and no official negative feedback.

INTERSECTION PROFILE 4: US-42 AT KY-872, FLORENCE, KY

© KYTC

Figure 122. Photo. US-42 at KY-872, Florence, Kentucky.

The junction of US-42 (Weaver Road) and KY-872 (Hopeful Church Road) is one of the busiest intersections in Florence, Kentucky and in August 2019 became home to the fourth QR intersection in the U.S. According to local officials, anyone who drives the route regularly knows the amount of time wasted waiting for the light to turn green.

This \$3.2 million project aims to change that. All left-turn traffic is diverted onto a newly constructed roadway (named Quadrant Roadway), a three-to-four lane undivided roadway that includes a mid-point access to parcels both adjacent to and inscribed by the quadrant roadway. One advantage that locals noted is that throughout the construction schedule during the remainder of the school year, impacts to commuter and bus traffic were minimal—motorists saw a lot of off-road construction but were only impacted during the final short changeover phase.

Several years of study and planning went into choosing the QR intersection alternative. Studies considered four options, including conventional widening and turn lane improvements, a longer quadrant roadway utilizing an existing roadway, a two-quadrant intersection (using the southwest and northeast quadrants), and the selected QR intersection with its new roadway. A roundabout was also considered at one of the secondary T-intersections; however, a single-lane roundabout did not provide sufficient capacity and a multi-lane roundabout was deemed too impactful.

Several of the factors for selecting the QR intersection alternative on the south side versus the other proposed alternatives included fewer access management issues, shorter projected queues and no major widening to either US-42 or KY-872 (only single left-turn lanes were required at each T-intersection). There were several access management issues to work out, including modifying access to a bank parcel. To avoid impacting a second bank parking lot, the eastbound right-turn lane on US-42 was slightly shortened. The relocation of the Weaver Road entrance to the strip mall in the south corner was viewed as a positive by businesses within the mall.

There were some concerns prior to opening that eastbound left turns that may cut through the strip mall parking lot on the northwest corner to turn on Hopeful Church Road and that the QR intersection may increase cut-through traffic on a nearby local street. While this did occur the week of opening, motorists familiar with the area quickly adapted to the new pattern which was found to be shorter than cut-throughs once the lights were synchronized. Aligning the entrance to the strip mall and opposite bank access helped eliminate the left-turn conflicts.

INTERSECTION PROFILE 5: US-220 AT CHURCH ST, GREENSBORO, NC

This partial QR intersection application has a long history. In 1977, the City of Greensboro, North Carolina conducted a study to improve the congested intersection of US-220 (Wendover Avenue) at Church Street, seen in figure 123. Excessive intersection congestion and delay was being caused by a high volume of left turns from Church Street onto US-220.

Several alternatives were considered including adding turn lanes and queue storage, conversion of Church Street to one-way, and the partial QR intersection. The City ultimately went with a partial QR intersection. The southbound Church Street left-turn movement was converted to a series of right turns using the existing street network. Advanced and overhead directional signs were used to reinforce this movement. Traffic operations were immediately improved after this partial QR improvement, and the PM peak hour bottleneck was immediately removed, never to return.

Since 1977, traffic volumes on US-220 have risen 300 percent and left-turn volumes are 375 percent greater. Despite the volume growth, the intersection continues to operate safely and efficiently. In 2007, a study was done to compute the operational benefits of the project. The study estimated that during the peak hour alone, there has been an estimated 2.3 million hours of reduced delays over the past 30 years.



© 2019 Google Earth®

Figure 123. Photo. US-220 at Church St. Greensboro, North Carolina.

INTERSECTION PROFILE 6: MARKET ST AT KERR AVE, WILMINGTON, NC

The US-17 Business (Market Street) and SR 1175 (Kerr Avenue) intersection in Wilmington, North Carolina, seen in figure 124, was one of several intersections included in a Kerr Avenue Widening Study conducted in 2010. Kerr Avenue interchanges with I-40 prior to the I-40 terminus at US-74 and is used as an alternate route to/from I-40 when the I-40/US-74 intersection is congested. With the Kerr Avenue widening in place, intersection volumes are forecast from 60,000 to 75,000 vpd by 2040. Traditional intersection options were not able to achieve the desired LOS at this location and interchange concepts were not feasible due to cost, and commercial / residential impacts. As a result, a variety of alternative concepts were developed and a QR concept was identified as the preferred alternative to mitigate congestion.

Multiple QR alternatives were developed for the intersection, including various roadway configurations in multiple quadrants. The heaviest left-turn demand was between the south and west legs. Eastbound drivers on Market Street would often use Cinema Drive to “cut the corner” to head south on Kerr Avenue, bypassing the Market Street / Kerr Avenue intersection. Signalizing the intersections of Cinema Drive with both Market Street and Kerr Avenue as part of a QR concept allowed northbound left turns to similarly “cut the corner” in the reverse direction. Construction of a second quadrant roadway on new alignment in the northeast intersection quadrant allows southbound left-turn movements to be removed from the main intersection.

In 2005, a single loop QR was proposed at another intersection in Wilmington; however, the project was put on hold due, in part, to negative public feedback over rerouting all left-turn movements. The community supported the Market Street / Kerr Avenue QR project because it only rerouted two lefts (rather than four) and did not force “right-to-go-left” movements that are not intuitive to drivers. To help the public understand operations and impacts, simulations were developed to visualize how drivers would navigate the QR intersection and explain impacts to commercial and residential access.

With the QR improvements in place (including both the repurposed and new quadrant roadways, four new signals, and lane improvements at the four secondary intersections), northbound and southbound left turns can be redirected, allowing the main intersection to operate with approximately half as much peak period delay compared to a conventional intersection. The dual QR concept also outperformed conventional intersection improvements during off-peak hours. In addition, access to businesses along each quadrant was improved by allowing road users to make signalized, direct left turns from the secondary intersections rather than make unsignalized movements.

The QR concept opened to traffic in the fall of 2018. While there was initially some driver confusion with the rerouted left turns, drivers have generally transitioned well into the new travel pattern. The City Traffic Engineer has been pleased with the operations so far and indicated that the dual QR intersection concept can eventually transition to reroute *all four* left turn movements in the future as the need arises.

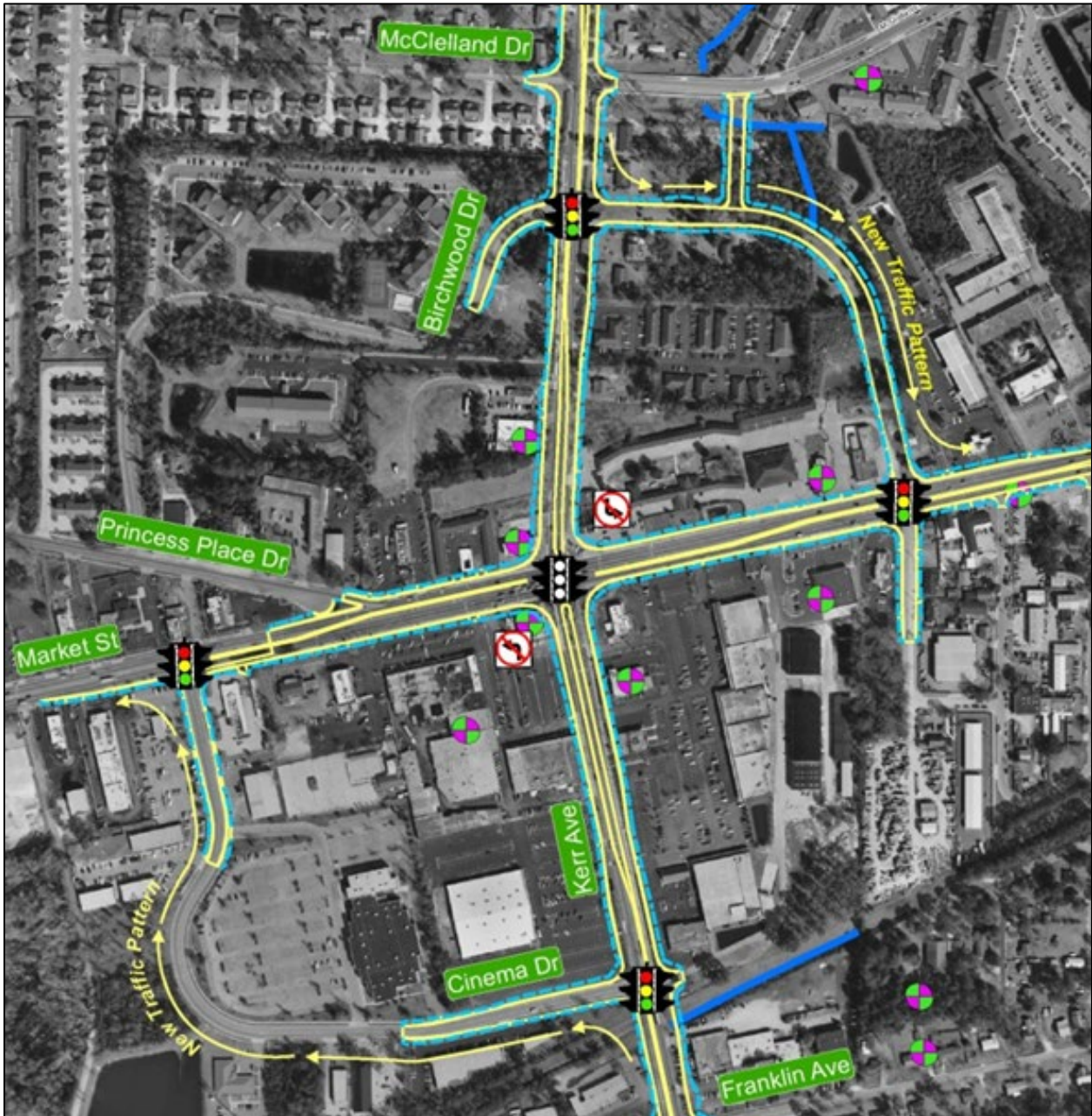

© NCDOT

Figure 124. Photo. Market Street at Kerr Avenue, Wilmington, North Carolina.

APPENDIX B – MARKETING / OUTREACH MATERIALS

Several agencies have utilized brochures, videos, and fact sheets to help explain the QR intersection. This appendix provides the following examples of outreach materials:

Informational Flyers

VDOT has developed an informational flyer for QR intersections and is posted on VDOT’s Innovative Intersections website. The flyer describes the geometric characteristics of a QR intersection and driving instructions, criteria for candidate locations, and the safety and operational benefits. The flyer can be found online at:

http://www.virginiadot.org/images/innovate/QR_Final_082417.pdf

Educational Videos

FHWA created alternative intersection and interchange informational videos case studies, which can be viewed on FHWA YouTube channel. While there are no specific videos of QR intersections, there are many videos that explain the importance of considering alternative intersections when evaluating intersection improvement alternatives. Figure 125 and figure 126 illustrate examples of the type of information provided in videos on the FHWA site.



Figure 125. Graphic. FHWA innovative intersection (RCUT) video.



Figure 126. Graphic. FHWA innovative intersection informational drive-through video.

Several agencies have developed educational videos as part their outreach for QR intersections projects. Figure 127 and figure 128 illustrate videos developed for the Huntersville, North Carolina and Front Royal, Virginia sites, respectively.



Figure 127. Graphic. Example of QR intersection video developed for Front Royal project.

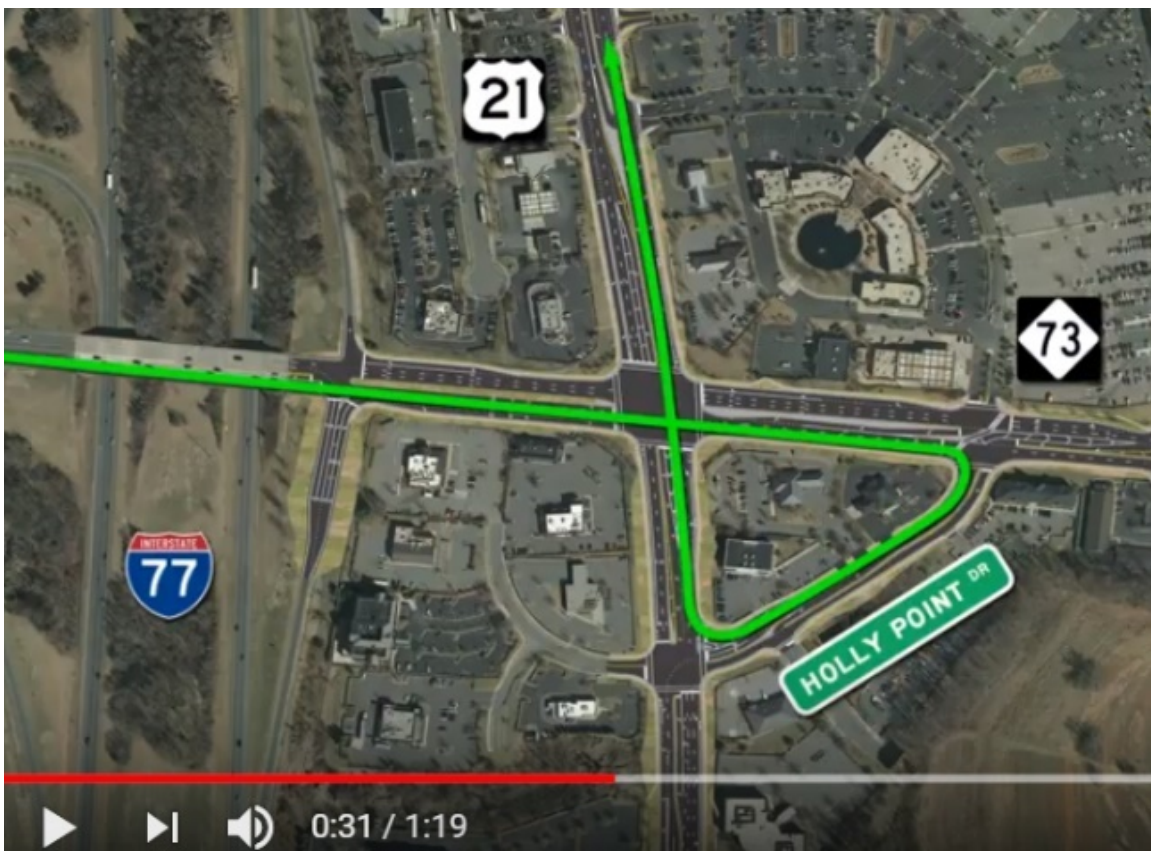

Figure 128. Graphic. Example of QR intersection video developed for Huntersville project.

Examples weblinks are provided below to other project or informational QR intersection videos.

- Huntersville Project Video: <https://www.youtube.com/watch?v=ZtIL2GqQJbs>
- VDOT South Forks Bridge Replacement Project Public Hearing Meeting (August 10, 2010): https://www.youtube.com/watch?v=NX_5q801JPg&t=1029s
- Warren County QR Project Overview: <https://www.youtube.com/watch?v=D0EU07YJYC4>
- Warren County QR Birds Eye: <https://www.youtube.com/watch?v=HfVvqymHHjk>
- Warren County QR (WB to SB): <https://www.youtube.com/watch?v=SERuuezKIyU>
- Warren County QR (NB to WB): <https://www.youtube.com/watch?v=hzdCnETDYp0>
- Generic QR Intersection Video: <http://attap.umd.edu/2015/11/11/quadrant-roadway/>
- E55th Opportunity Corridor Interchange: https://www.youtube.com/watch?v=Vk9Io8q_58w

VDOT has also developed an “Innovative Intersections and Interchanges” website that contains some useful information, brochures and videos that help explain the QR intersections found here:

http://www.virginiadot.org/info/innovative_intersections_and_interchanges/qr.asp

<https://youtu.be/eJwYLR88WsA>

APPENDIX C – ARTICLES, PAPERS, AND PUBLICATIONS

Several articles, briefs, and technical papers have been written to describe the QR intersection as an alternative intersection concept or for a specific build or planned project.

FHWA QR Intersection Tech Brief

The FHWA QR Intersection Tech Brief was published in 2009 and provides an overview of the QR Intersection that summarizes its geometric design, traffic signal control, operational performance, safety performance, and applicability. This publication can be found online at: <https://www.fhwa.dot.gov/publications/research/safety/09058/09058.pdf>

ITE Journal Article (June 2000)

This article introduces the QR Intersection as an alternative/innovative intersection. It explains scenarios where a QR Intersection could improve intersection efficiency by relocating left turns and therefore reducing cycle length, delay, and queue lengths. The article provides detail on the design considerations, traffic signal operations, comparative analysis of intersection efficiency, advantages, and disadvantages. The article concludes with statistics showing that QR Intersection improves stopped-delay and reduces system travel times (22 percent) when compared to a traditional intersection. This publication can be found online at: <https://pdfs.semanticscholar.org/3d42/35ab4a1672edaa1ef0cea6f70cee46162a3d.pdf>

APWA Reporter article (July 2013)

This article provides four lessons learned from a QR Intersection constructed in Fairfield, OH in January 2012. Lesson #1 says to avoid opening before all lanes and movements can be opened to avoid driver confusion. Lesson #2 stated the importance of communicating the changes regarding driver behavior and intuition. Lesson #3 stated that left turn movement at the main intersection should be restricted with physical barriers. Lesson #4 notes that QR Intersections (and this one in particular) should be sustainable for the environment, economy, and the community's health. This publication can be found online at: https://www.apwa.net/Library/Reporter/201307_ReporterOnline.pdf

ACKNOWLEDGEMENTS

Publication of the Quadrant Roadway (QR) Informational Guide was provided by FHWA. The technical writing of the guide was provided through funding from the North Carolina Department of Transportation. Special thanks to Kevin Lacy, State Traffic Engineer, and Joseph Hummer, State Traffic Management Engineer, for facilitating the funding and peer review of this QR Informational Guide document.

NCDOT and its subcontractors has granted FHWA with unlimited use of all figures, graphs, and photos presented in this guide, unless otherwise credited in the document.

Aerial images cited throughout the document are copyright property of Google® Earth and used by permission. Information on Google Earth can be accessed at <https://www.google.com/earth>.

REFERENCES

1. Reid, Jonathan D. Using Quadrant Roadways to Improve Arterial Intersection Operations. ITE Journal, Vol. 70, No. 6, June 2000, pp. 34–36, 43–45.
2. Partial QR Intersection. Map. Google Maps. Accessed May 1, 2019. <https://www.google.com/maps/@35.44148,-80.86457,733m/data=!3m1!1e3>
3. Designing Walkable Urban Thoroughfares: A Context Sensitive Approach; ITE Publication No. RP-036A, 2010.
4. Dual Quadrant Intersection. Map. Google Maps. Accessed May 1, 2019. <https://www.google.com/maps/@44.0288257,-121.3165517,243m/data=!3m1!1e3>
5. Four-Quadrant Intersection. Map. Google Maps. Accessed May 1, 2019. <https://www.google.com/maps/@34.0678479,-84.1691573,1085m/data=!3m1!1e3>
6. Grade-separated single-quadrant interchange. Map. Google Maps. Accessed May 1, 2019. <https://www.google.com/maps/@39.418152,-76.7792529,265m/data=!3m1!1e3>
7. Grade-separated single-quadrant interchange. Map. Google Maps. Accessed May 1, 2019. <https://www.google.com/maps/@42.5453444,-83.2840732,208m/data=!3m1!1e3>
8. American Association of State Highway and Transportation Officials (AASHTO). A Policy on the Geometric Design of Highways and Streets. Washington, DC: AASHTO, 2011.
9. Transportation Research Board. Highway Capacity Manual (HCM) 6th Edition. Washington, DC: TRB, National Research Council (NRC), 2018.
10. Federal Highway Administration (FHWA). Manual on Uniform Traffic Control Devices. Washington, DC: U.S. Department of Transportation (USDOT), 2009.
11. Federal Highway Administration (FHWA). Signalized Intersections: Informational Guide. USDOT: Washington, DC, 2013.
12. AASHTO. Highway Safety Manual (HSM). Washington, DC: AASHTO, 2010.
13. FHWA. Alternative Intersection/Interchanges: Informational Report (AIIR), Report No. FHWA-HRT-09-060. Washington, DC: USDOT, 2010.
14. FHWA. Techbrief: Quadrant Roadway Intersection, Report No. FHWA-HRT-09-058, October 2009.
15. An Update on the Quadrant Roadway Intersection; Reid, J.D; presented at the TRB 5th Urban Street Symposium, 2017.
16. FHWA’s Every Day Counts Program Center for Accelerating Innovation. <https://www.fhwa.dot.gov/innovation/everydaycounts/edc-2/geometrics.cfm>
17. <https://fatpencilstudio.com/blog/traffic-simulation/>
18. United States Access Board, Accessible Public Rights of Way webpage. <http://www.access-board.gov/>
19. Public Right-of-Way Accessibility Guidelines; United States Access Board publication, 2011.
20. FHWA Context Sensitive Solutions. U.S. Department of Transportation webpage. <https://www.fhwa.dot.gov/planning/css/>

21. FHWA RCUT Informational Guide; published 2014.
https://safety.fhwa.dot.gov/intersection/alter_design/pdf/fhwasa14070_rcut_infoguide.pdf
22. NC-73 / US-21 Spot Safety Project Evaluation conducted by the North Carolina Department of Transportation; completed May 9, 2017.
23. SR4 / SR-4 Bypass crash data provided by City of Fairfield, OH.
24. US-340/522 at SR-55 crash data provided by Virginia Department of Transportation Staunton District.
25. Federal Highway Administration (FHWA). A Guide to Developing Quality Crash Modification Factors. USDOT: Washington, DC, 2010.
26. <https://www.seattlebikeblog.com/2013/08/01/sdot-on-how-to-use-two-stage-left-turn-boxes/>
27. Reid, Jonathan D., and Hummer, Joseph E. Travel Time Comparisons Between Seven Unconventional Arterial Intersection Designs. Transportation Research Board, Transportation Research Record 1751, Paper No. 01-2957, 2001, pp. 56-66.
28. Reese, Michael P., Carroll, Justin T., and Epperson, Sean M. North Carolina's First Quadrant Left: History and Lessons Learned, Transportation Research Board, Paper No. 15-2138, November 2013.
29. FHWA Traffic Analysis Toolbox.
www.fhwa.dot.gov/publications/research/infrastructure/pavements/ltp/04038/index.cfm
30. Transportation Systems Institute. Capacity Analysis for Planning of Junctions (CAP-X). Version 1.2 (2011). <http://tsi.cecs.ucf.edu/index.php/cap-x>
31. VJUST analysis tool.
http://www.virginiadot.org/business/resources/LocDes/01_VJuST_Ver1.02.xlsm
32. FHWA's Traffic Analysis Tools website:
<https://ops.fhwa.dot.gov/trafficanalysistools/index.htm>
33. Joseph Hummer, Michael Reece and Bailey Harden. The Potential of a Seven-Phase Signal to Provide Access without Sacrificing Mobility. Institute of Transportation Engineers Journal. January 2019, pp 38-42.
34. <https://www.seattlebikeblog.com/2013/08/01/sdot-on-how-to-use-two-stage-left-turn-boxes/>
35. Mann, Ben and Hoying, Daniel. Alternative Intersection Design Delivers. APWA Reporter. July 2013, pp. 60-63.