



U.S. Department of Transportation
**Federal Highway
Administration**



RESTRICTED CROSSING U-TURN INTERSECTION

Informational Guide

August 2014

FOREWORD

The Federal Highway Administration (FHWA) Every Day Counts (EDC) initiative is designed to identify and deploy innovation aimed at reducing project delivery time, enhancing safety and protecting the environment. In 2012, FHWA chose Intersection & Interchange Geometrics (IIG) to feature as one of the innovative technologies in EDC-2. Specifically, IIG consists of a family of alternative intersection designs that improve intersection safety while also reducing delay, and at lower cost and with fewer impacts than comparable traditional solutions.

As part of the effort to mainstream these intersections, FHWA has produced a series of guides to help transportation professionals routinely consider and implement these designs. Concurrent with this Restricted Crossing U-turn (RCUT) Informational Guide, FHWA developed and published guides for three other designs: Median U-turn (MUT), Displaced Left Turn (DLT), and Diverging Diamond Interchange (DDI). These guides represent summaries of the current state of knowledge and practice, and are intended to inform project planning, scoping, design and implementation decisions.

An electronic version of this document is available on the Office of Safety website at <http://safety.fhwa.dot.gov/>. Additionally, limited quantities of hard copies are available from the Report Center; inquiries may be directed to report.center@dot.gov or 814-239-1160.



Michael S. Griffith
Director
Office of Safety Technologies

Notice

This document is disseminated under the sponsorship of the U.S. Department of Transportation in the interest of information exchange. The U.S. Government assumes no liability for the use of the information contained in this document. This report does not constitute a standard, specification, or regulation.

The U.S. Government does not endorse products or manufacturers. Trademarks or manufacturers' names appear in this report only because they are considered essential to the objective of the document.

Quality Assurance Statement

The Federal Highway Administration (FHWA) provides high-quality information to serve Government, industry, and the public in a manner that promotes public understanding. Standards and policies are used to ensure and maximize the quality, objectivity, utility, and integrity of its information. FHWA periodically reviews quality issues and adjusts its programs and processes to ensure continuous quality improvement.

Technical Report Documentation Page

1. Report No. FHWA-SA-14-070	2. Government Accession No.	3. Recipient's Catalog No.	
4. Title and Subtitle Restricted Crossing U-turn Informational Guide		5. Report Date August 2014	
		6. Performing Organization Code	
7. Authors Joe Hummer, Wayne State University; Brian Ray, Andy Daleiden, Pete Jenior, Julia Knudsen, Kittelson & Associates, Inc.		8. Performing Organization Report No. Project 13517	
		9. Performing Organization Name and Address Kittelson & Associates, Inc. 610 SW Alder Street, Suite 700 Portland, OR 97205	
12. Sponsoring Agency Name and Address U.S. Department of Transportation Federal Highway Administration Office of Safety 1200 New Jersey Ave., SE Washington, DC 20590		10. Work Unit No. (TRAIS)	
		11. Contract or Grant No. TO DTFH61-00023-T-13002	
13. Type of Report and Period Technical Report Informational Report September 2013 to August 2014		14. Sponsoring Agency Code FHWA	
		15. Supplementary Notes Jeffrey Shaw (jeffrey.shaw@dot.gov), Office of Safety Technologies (http://safety.fhwa.dot.gov/), served as the Technical Manager for the Federal Highway Administration (FHWA). The following FHWA staff contributed as technical working group members, reviewers and/or provided input or feedback to the project at various stages: Joe Bared, Mark Doctor, Brian Fouch, Elizabeth Hilton, Jim McCarthy, George Merritt, Will Stein, Jim Sturrock and Wei Zhang.	
16. Abstract This document provides information and guidance on Restricted Crossing U-Turn (RCUT) intersections. To the extent possible, the guide addresses a variety of conditions found in the United States, to achieve designs suitable for a wide array of potential users. This guide provides general information, planning techniques, evaluation procedures for assessing safety and operational performance, design guidelines, and principles to be considered for selecting and designing RCUT intersections.			
17. Key Words RCUT, Superstreet, J-turn, Restricted Crossing U-turn, Reduced Conflict Intersection, Synchronized Street, Alternative Intersections, Innovative Intersections		18. Distribution Statement No restrictions.	
19. Security Classif. (of this report) Unclassified	20. Security Classif. (of this page) Unclassified	21. No. of Pages 186	22. Price

Restricted Crossing U-turn Informational Guide

SI* (MODERN METRIC) CONVERSION FACTORS				
APPROXIMATE CONVERSIONS TO SI UNITS				
Symbol	When You Know	Multiply By	To Find	Symbol
LENGTH				
in	inches	25.4	millimeters	mm
ft	feet	0.305	meters	m
yd	yards	0.914	meters	m
mi	miles	1.61	kilometers	km
AREA				
in ²	square inches	645.2	square millimeters	mm ²
ft ²	square feet	0.093	square meters	m ²
yd ²	square yard	0.836	square meters	m ²
ac	acres	0.405	hectares	ha
mi ²	square miles	2.59	square kilometers	km ²
VOLUME				
fl oz	fluid ounces	29.57	milliliters	mL
gal	gallons	3.785	liters	L
ft ³	cubic feet	0.028	cubic meters	m ³
yd ³	cubic yards	0.765	cubic meters	m ³
NOTE: volumes greater than 1000 L shall be shown in m ³				
MASS				
oz	ounces	28.35	grams	g
lb	pounds	0.454	kilograms	kg
T	short tons (2000 lb)	0.907	megagrams (or "metric ton")	Mg (or "t")
TEMPERATURE (exact degrees)				
°F	Fahrenheit	5 (F-32)/9 or (F-32)/1.8	Celsius	°C
ILLUMINATION				
fc	foot-candles	10.76	lux	lx
fl	foot-Lamberts	3.426	candela/m ²	cd/m ²
FORCE and PRESSURE or STRESS				
lbf	poundforce	4.45	newtons	N
lbf/in ²	poundforce per square inch	6.89	kilopascals	kPa
APPROXIMATE CONVERSIONS FROM SI UNITS				
Symbol	When You Know	Multiply By	To Find	Symbol
LENGTH				
mm	millimeters	0.039	inches	in
m	meters	3.28	feet	ft
m	meters	1.09	yards	yd
km	kilometers	0.621	miles	mi
AREA				
mm ²	square millimeters	0.0016	square inches	in ²
m ²	square meters	10.764	square feet	ft ²
m ²	square meters	1.195	square yards	yd ²
ha	hectares	2.47	acres	ac
km ²	square kilometers	0.386	square miles	mi ²
VOLUME				
mL	milliliters	0.034	fluid ounces	fl oz
L	liters	0.264	gallons	gal
m ³	cubic meters	35.314	cubic feet	ft ³
m ³	cubic meters	1.307	cubic yards	yd ³
MASS				
g	grams	0.035	ounces	oz
kg	kilograms	2.202	pounds	lb
Mg (or "t")	megagrams (or "metric ton")	1.103	short tons (2000 lb)	T
TEMPERATURE (exact degrees)				
°C	Celsius	1.8C+32	Fahrenheit	°F
ILLUMINATION				
lx	lux	0.0929	foot-candles	fc
cd/m ²	candela/m ²	0.2919	foot-Lamberts	fl
FORCE and PRESSURE or STRESS				
N	newtons	0.225	poundforce	lbf
kPa	kilopascals	0.145	poundforce per square inch	lbf/in ²

*SI is the symbol for the International System of Units. Appropriate rounding should be made to comply with Section 4 of ASTM E380. (Revised March 2003)

TABLE OF CONTENTS

CHAPTER 1— INTRODUCTION..... 1
OVERVIEW OF ALTERNATIVE INTERSECTIONS AND INTERCHANGES 1
INTERSECTION CONTROL EVALUATIONS AND CONSIDERATIONS 1
ORGANIZATION OF THE GUIDELINES 2
SCOPE OF THE GUIDE..... 3
RCUT INTERSECTION OVERVIEW 3
APPLICATION 7
RESOURCE DOCUMENTS..... 13

CHAPTER 2— POLICY AND PLANNING 15
PLANNING CONSIDERATIONS FOR ALTERNATIVE INTERSECTIONS AND
INTERCHANGES..... 15
STAKEHOLDER OUTREACH..... 17
POLICY CONSIDERATIONS 21
PLANNING CONSIDERATIONS 22
PLANNING CHALLENGES 24
PROJECT PERFORMANCE CONSIDERATIONS 25
PROJECT DEVELOPMENT PROCESS..... 26
SUMMARY OF RCUT ADVANTAGES AND DISADVANTAGES 27

CHAPTER 3—MULTIMODAL CONSIDERATIONS..... 31
DESIGN PRINCIPLES AND APPROACH 31
PEDESTRIANS 32
BICYCLISTS..... 42
TRANSIT VEHICLE CONSIDERATION 47
HEAVY VEHICLE CONSIDERATIONS..... 49

CHAPTER 4 — SAFETY 51
SAFETY PRINCIPLES 51
OBSERVED SAFETY PERFORMANCE..... 54
SAFETY CONSIDERATIONS..... 58
INCIDENT RESPONSE CONSIDERATIONS 61
SAFETY EVALUATION CONSIDERATIONS..... 61

CHAPTER 5 — OPERATIONAL CHARACTERISTICS 63
OPERATIONAL PRINCIPLES 63
SYSTEM-WIDE CONSIDERATIONS 76
COMPARATIVE PERFORMANCE STUDIES..... 79

CHAPTER 6 — OPERATIONAL ANALYSIS	83
OPERATIONAL ANALYSIS OVERVIEW	84
PLANNING ANALYSIS	87
HIGHWAY CAPACITY MANUAL (HCM) ANALYSIS	88
MICROSIMULATION ANALYSIS	91
CHAPTER 7 — GEOMETRIC DESIGN	95
DESIGN APPROACH	95
GEOMETRIC DESIGN PARAMETERS/PRINCIPLES	98
RANGE OF RCUT CONFIGURATIONS	98
OPERATIONAL EFFECTS OF GEOMETRIC DESIGN	102
DESIGN GUIDANCE	104
CHAPTER 8--SIGNALS, SIGNING, MARKING, AND LIGHTING	121
DESIGN PRINCIPLES AND APPROACH	121
SIGNALIZED VERSUS UNSIGNALIZED RCUT INTERSECTIONS	121
SIGNALS	122
SIGNING	129
PAVEMENT MARKINGS	137
LIGHTING	138
CHAPTER 9 – CONSTRUCTION AND MAINTENANCE	141
CONSTRUCTION	141
COSTS	145
MAINTENANCE	149
LAW ENFORCEMENT NEEDS	150
REFERENCES	153
Appendix A CATALOG OF ALL KNOWN INSTALLATIONS IN THE UNITED STATES	157
Appendix B SUPPLEMENTAL OPERATIONAL AND SAFETY DETAILS	159
Appendix C MARKETING AND OUTREACH MATERIALS	165

List of Exhibits

Exhibit 1-1. Example of a RCUT intersection with signals.....	5
Exhibit 1-2. Example of a RCUT intersection with stop-control.	5
Exhibit 1-3. Example of a RCUT intersection with merges.	6
Exhibit 1-4. Locations of RCUT Intersections.	7
Exhibit 1-5. Signalized RCUT intersection on US-281 in San Antonio, TX with four-lane major street and four-lane minor street. ⁽²⁾	8
Exhibit 1-6. Stop-controlled RCUT intersection on US-1 near Southern Pines, NC. ⁽²⁾	9
Exhibit 1-7. Merge-controlled RCUT intersection on US-15 in Emmitsburg, MD. ⁽³⁾	9
Exhibit 1-8. RCUT intersection on US-15/501 in Chapel Hill, NC with no left-turn crossovers. ⁽²⁾	10
Exhibit 1-9. Loon implemented on RCUT intersection in Wilmington, NC. ⁽³⁾	11
Exhibit 1-10. Signalized RCUT intersection in operation near San Antonio, TX showing a pedestrian “Z” crossing. ⁽³⁾	11
Exhibit 1-11. Three-legged RCUT intersection on US-17 at Brunswick Forest Parkway in Leland, NC. ⁽²⁾	12
Exhibit 1-12. RCUT corridor on US-17 in Leland, NC. ⁽⁴⁾	13
Exhibit 2-1. Relationship between total entering volume and intersection type.	17
Exhibit 2-2. Superstreet intersection public brochure from NCDOT. ⁽⁴⁾	19
Exhibit 2-3. Superstreet intersection graphic by NCDOT. ⁽¹⁵⁾	20
Exhibit 2-4. Reduced conflict intersection video by MnDOT. ⁽¹⁶⁾	20
Exhibit 2-5. J-Turn intersection video by MoDOT. ⁽¹⁷⁾	21
Exhibit 2-6. Project development process.	26
Exhibit 3-1. Pedestrian movements in a RCUT intersection.	32
Exhibit 3-2. Signalized RCUT with “Z” crossing near San Antonio, TX. ⁽³⁾	33
Exhibit 3-3. Pedestrian-vehicle conflict points at conventional intersection.....	34
Exhibit 3-4. Pedestrian-vehicle conflict points at RCUT intersection.....	34
Exhibit 3-5. RCUT intersection with minor street approaches offset to produce a shorter pedestrian crossing.....	35
Exhibit 3-6. Three types of signalized mid-block crossing feasible on RCUT corridor.	36
Exhibit 3-7. Pedestrian crossing of three-legged RCUT intersection.	37
Exhibit 3-8. Alternative crossing treatments and modeled operational performance for pedestrians.....	38
Exhibit 3-9. Median shared-use path design for the US Route 15/501 RCUT intersection in North Carolina. ⁽²⁵⁾	39
Exhibit 3-10. Two-stage channelized pedestrian crossing at conventional intersection. ⁽²⁵⁾	40
Exhibit 3-11. Right-turn lane with bicycle lane.....	43
Exhibit 3-12. Minor street through options for bicycles.....	44
Exhibit 3-13. Curb cut design used in North Carolina to assist bicyclists crossing at a rural RCUT with stop sign. ⁽²⁷⁾	45
Exhibit 3-14. Alternative crossing treatments and modeled operational performance for bicyclists.	46
Exhibit 3-15. Potential bus stop locations at a RCUT intersection.....	47
Exhibit 3-17. RCUT intersection major street bus stop placement options between U-turn crossovers.....	49
Exhibit 4-1. Conflict point comparison.	52

Restricted Crossing U-turn Informational Guide

Exhibit 4-2. Vehicular conflict points at a four-approach conventional intersection.	52
Exhibit 4-3. Vehicular conflict points at a four-approach RCUT intersection.	52
Exhibit 4-4. Typical site in NCDOT study of RCUT intersections with stop signs. ⁽²⁾	55
Exhibit 4-5. Results of analyses of RCUT intersections with stop signs in North Carolina. ⁽¹¹⁾ ...	56
Exhibit 4-6. Typical site from FHWA study of Maryland RCUT intersections with merges. ⁽³⁾ ..	57
Exhibit 4-7. Summary of empirical safety studies of unsignalized RCUT intersections.	58
Exhibit 4-8. Example of U-turn/right-turn conflict. ⁽³⁾	59
Exhibit 4-9. U-turn crossover detail. ⁽²⁸⁾	60
Exhibit 4-10. Dual-lane crossover design overtracking potential.....	61
Exhibit 5-1. Concurrent movements at conventional intersection and signalized RCUT intersection.....	64
Exhibit 5-2. Signal placement at signalized RCUT intersection.	65
Exhibit 5-3 Signal progression on a RCUT corridor.	66
Exhibit 5-4. Signal phasing for a RCUT intersection with four controllers.	69
Exhibit 5-5. Signal phasing for a RCUT intersection with one controller and a single concurrent pedestrian phase to allow pedestrians to cross the major street.....	70
Exhibit 5-6. Signal phasing for a RCUT intersection with one controller in which pedestrians cross the major street at two separated signal-controlled crosswalks.....	71
Exhibit 5-7. Feasible demand space for signalized RCUT intersection.	75
Exhibit 5-8. RCUT corridor in Leland, NC. ⁽⁴⁾	77
Exhibit 5-9. Progression in RCUT corridors radiating outward from one non-RCUT intersection.	78
Exhibit 5-10. Corridor with RCUT intersections only where needed to provide two-way progression.....	79
Exhibit 5-11. RCUT simulation results, average of four time of day periods.....	80
Exhibit 5-12. Operational measures on US-281 north of San Antonio before and after RCUT intersection installation. ⁽³⁵⁾	82
Exhibit 6-1. RCUT Analysis Techniques	85
Exhibit 6-2. Translating turning movements at a conventional intersection into a RCUT intersection.....	86
Exhibit 6-3. CAP-X planning level tool screen capture. ⁽³⁶⁾	88
Exhibit 6-4. Preliminary guidance from FHWA research on key parameters in operation analysis of signalized RCUT intersections.	91
Exhibit 6-5. Final gap values after calibration. ⁽¹¹⁾	93
Exhibit 7-1. Characteristics of a RCUT intersection with signals.....	96
Exhibit 7-2. Characteristics of a RCUT intersection with stop-control.....	96
Exhibit 7-3. Characteristics of a RCUT intersection with merges.....	97
Exhibit 7-4. Stop-controlled RCUT intersection on US-1 near Southern Pines, NC. ⁽²⁾	100
Exhibit 7-5. Merge-controlled RCUT intersection on US-15 in Emmitsburg, MD. ⁽³⁾	100
Exhibit 7-6. Signalized RCUT intersection on OH-4 outside Hamilton, OH with six-lane major highway and four-lane minor road. ⁽²⁾	101
Exhibit 7-7. Signalized RCUT intersection on Big Beaver Road in Troy, MI with six-lane major street and four-lane minor street. ⁽³⁾	102
Exhibit 7-8. RCUT intersection with three-approaches.....	102
Exhibit 7-9. RCUT intersection angle considerations.	104

Exhibit 7-10. RCUT intersection schematic from NCDOT showing left-turn crossover dimensions.⁽³⁷⁾ 106

Exhibit 7-11. Minor street left turn crossover with a merge on Woodward Avenue in Birmingham, MI.⁽²⁾ 107

Exhibit 7-12. Schematic of RCUT intersection with one-lane, minor street approaches. 109

Exhibit 7-13. Signalized RCUT intersection with multiple lanes and channelization on the minor street. 110

Exhibit 7-14. Area near U-turn crossover where access point should be avoided. 111

Exhibit 7-15. Back-to-back crossovers on Big Beaver Road in Troy, MI.⁽²⁾ 112

Exhibit 7-16. Loon implemented on RCUT intersection in Wilmington, NC.⁽³⁾ 113

Exhibit 7-17. Other treatments used at U-turn crossovers on Twelve Mile Road in Farmington Hills, MI to accommodate large vehicles.⁽²⁾ 114

Exhibit 7-18. AASHTO-recommended minimum median widths for U-turn crossovers.⁽⁵⁾ 115

Exhibit 7-19. RCUT intersection with back-to-back two-lane crossover storage bays. 115

Exhibit 7-20. U-turn crossover design on highway with curbs.⁽²⁸⁾ 116

Exhibit 7-21. U-turn crossover design on highway without curbs.⁽²⁸⁾ 116

Exhibit 7-22. Spacing consideration for a minor street through or left movement. 118

Exhibit 8-1. RCUT intersection with four separate controllers. 122

Exhibit 8-2. RCUT intersection with three separate controllers. 123

Exhibit 8-3. RCUT intersection with two separate controllers. 124

Exhibit 8-4. RCUT intersection with a single controller. 124

Exhibit 8-5. Possible signal pole and mast arm locations for RCUT intersection. 126

Exhibit 8-6. Signal pole locations at the main intersection of a RCUT intersection on US-17 in North Carolina.⁽³⁾ 126

Exhibit 8-7. Signal pole locations at the main intersection of another RCUT intersection on US-17 in North Carolina.⁽³⁾ 127

Exhibit 8-8. Signal pole locations at the U-turn crossover of a RCUT intersection on US-17 in North Carolina.⁽³⁾ 127

Exhibit 8-9. Signal pole locations on the minor street approaches of a RCUT intersection on US-17 in North Carolina.⁽³⁾ 128

Exhibit 8-10. Potential detector placements. 129

Exhibit 8-11. Signalized RCUT intersection signing plan derived from Maryland practice.⁽³⁾ . 131

Exhibit 8-12. Guide signs for U-turn crossovers based on Maryland (left side) and Texas (right side) practice. 132

Exhibit 8-13. Overhead lane use signs provided on minor street (Evans Road) approaching major street (US-281 in San Antonio, TX). 133

Exhibit 8-14. RCUT intersection with traffic island separating minor street right turn movements from minor street through and left turn movements.⁽²⁾ 134

Exhibit 8-15. Overhead guide signs at the RCUT intersection on US-15/501 in Chapel Hill, NC.⁽²⁷⁾ 135

Exhibit 8-16. Stop-controlled RCUT intersection signing guidance from NCDOT practice.⁽⁴⁰⁾ 136

Exhibit 8-17. Signing at a merge-controlled RCUT intersection in Emmitsburg, Maryland.⁽³⁾ . 137

Exhibit 8-18. Typical pavement marking at a directional crossover.⁽²⁸⁾ 138

Exhibit 8-19. Pavement markings at a directional crossover with dual lanes.⁽²⁸⁾ 138

Exhibit 9-1. Construction staging when widening the street when converting two-lane road to multilane RCUT intersection.⁽³⁾ 142

Exhibit 9-2. Construction staging for converting a conventional intersection to a RCUT intersection.⁽³⁾ 144

Exhibit 9-3. Summary of costs associated with RCUT intersections. 146

Exhibit 9-4. RCUT intersection used in theoretical cost comparison.⁽³⁾ 147

Exhibit 9-5. Conventional intersection alternatives used for cost comparison.⁽³⁾ 148

Exhibit 9-6. Footprint comparisons of a RCUT intersection versus conventional intersections. 149

CHAPTER 1— INTRODUCTION

OVERVIEW OF ALTERNATIVE INTERSECTIONS AND INTERCHANGES

Alternative intersections and interchanges offer the potential to improve safety and reduce delay at a lower cost and with fewer impacts than traditional solutions. However, transportation professionals are generally unfamiliar with many alternative intersection and interchange forms, partially because some forms have only a few installations in operation or because installations are concentrated in a few states. Furthermore, at the national level, well-documented and substantive resources needed for planning, analysis, design and public outreach and education, were limited.

Concurrent with this Restricted Crossing U-turn (RCUT) Informational Guide, the Federal Highway Administration (FHWA) developed and published informational guides for three other alternative intersection and interchange forms: Median U-turn (MUT), Displaced Left Turn (DLT), and Diverging Diamond Interchange (DDI). These guides are intended to increase awareness of these specific alternative intersections and interchanges and provide guidance on how to plan, design, construct, and operate them. These guidelines represent summaries of the current state of knowledge with the intent of supporting decisions when considering and potentially selecting alternative intersection and interchange forms for appropriate applications.

INTERSECTION CONTROL EVALUATIONS AND CONSIDERATIONS

The term “intersection” means the junction of two or more street facilities. In some cases, this may specifically mean an “at-grade” intersection form. In others, it may include the junction of two or more streets requiring partial or complete grade separation (“interchanges”). A number of state and city transportation agencies have or are implementing intersection control evaluation processes or policies as a means of integrating the widest range of intersection forms as project solutions. For example, California, Indiana, Minnesota, and Wisconsin have policies or processes to objectively consider and select the most appropriate intersection form for a given project context.

Many of the policies or processes include common objectives in selecting the optimal or preferred intersection control alternative for a given project context. The common elements generally include but are not limited to the following:

- Understanding the intended context, and how operations, safety, and geometry fit the context for each intersection or corridor including intended users (pedestrians, bicyclists, passenger cars, transit vehicles, freight, emergency responders, and over size/over weight [OSOW] vehicles)
- Identifying and documenting the overall corridor or intersection context including the built, natural, and community environment and the intended performance outcomes of the intersection form
- Considering and assessing a wide range of traffic control strategies and other practical improvement concepts to identify worthy project-level technical evaluation

- Comparing engineering and economic analysis results of practical alternatives that consider implementation costs, performance benefits and impacts (safety, multimodal, operations, environment, etc.), and the estimated service life of alternatives

ORGANIZATION OF THE GUIDELINES

This guide is structured to address the needs of a variety of readers, including the general public, policy makers, transportation planners, operations and safety analysts, and conceptual and detailed designers. This chapter distinguishes RCUT intersections from conventional intersections and provides an overview of each chapter in the guide. The remaining chapters increase in the level of detail provided.

Chapter 2: Policy and Planning—This chapter provides guidance on when to consider alternative intersections in general and RCUT intersections in particular. This chapter provides an overview of the policies, project challenges, performance measures, and project development process throughout the duration of the project to balance trade-offs.

Chapter 3: Multimodal Considerations—This chapter provides an overview of multimodal facilities at RCUT intersections and how various types of users can be safely integrated into the design.

Chapter 4: Safety—This chapter summarizes the safety performance at RCUT intersections based on studies completed by state agencies and recent research efforts. Although the documented safety performance of RCUT intersections is limited, information about conflict points and emergency services are discussed in this chapter.

Chapter 5: Operational Characteristics—This chapter provides information on the unique operational characteristics of RCUT intersections and how they affect elements such as traffic signal phasing and coordination. The chapter also provides guidance for practitioners related to design elements such as driveways that may affect the operational performance of RCUT intersections. It describes the unique operational characteristics of RCUT intersections and prepares transportation professionals for conducting operational analysis as described in Chapter 6.

Chapter 6: Operational Analysis—This chapter presents an overview of the approach and tools available for conducting a traffic operations analysis of a RCUT intersection.

Chapter 7: Geometric Design—This chapter describes the typical RCUT intersection design approach and provides guidance for geometric features. Design of a RCUT intersection will also require reviewing and integrating the intersection's multimodal considerations (Chapter 3), safety assessment (Chapter 4), and traffic operational analysis (Chapters 5 and 6).

Chapter 8: Signal, Signing, Marking, and Lighting—This chapter presents information relating to the design and placement of traffic control devices at RCUT intersections, including traffic signals, signs, and pavement markings, as well as intersection lighting.

Chapter 9: Construction and Maintenance—This chapter focuses on the constructability and maintenance of a RCUT intersection.

An Appendix is included at the end of this guide for the purpose of providing more detailed information about many of the resources and best practices presented in the guide. The Appendix contains the following information:

- A - Catalog of all known installations in the United States
- B - Supplemental operational and safety details
- C - Marketing and outreach materials
- D - Supplemental construction and design details

SCOPE OF THE GUIDE

This document provides information and guidance on RCUT intersections, resulting in designs suitable for a variety of typical conditions commonly found in the United States. To the extent possible, the guide provides information on the wide array of potential users as it relates to the intersection form. This guide provides general information, planning techniques, evaluation procedures for assessing safety and operational performance, design guidelines, and principles to be considered for selecting and designing RCUT intersections. This guide does not include specific legal or policy requirements; however, Chapter 2 provides information on planning topics and considerations when investigating intersection control forms. This first edition of the Restricted Crossing U-turn Informational Guide has been developed from documented practices and prior research. As more RCUT intersections are built, there will be opportunities to conduct research to refine existing and develop new methods to inform project decisions about this intersection form.

RCUT INTERSECTION OVERVIEW

The Restricted Crossing U-turn (RCUT) intersection is also known as a superstreet intersection, a J-turn intersection, and synchronized street intersection. The RCUT intersection differs from a conventional intersection by eliminating the left-turn and through movements from cross street approaches. To accommodate these movements, the RCUT intersection requires drivers to turn right onto the main road and then make a U-turn maneuver at a one-way median opening at least 400 feet after the intersection. At the main street approaches, the left turns are typically accommodated similar to left turns at conventional intersections. In some cases, such as rural unsignalized RCUT intersection designs, left-turn movements from the main street could also be removed. RCUT intersections can have either three or four legs. In the case of a four-legged RCUT intersection, there are two U-turn crossovers, and minor street left-turn and through movements are not allowed to be made directly at the intersection.

There are three main types of RCUT intersections, including:

- **Signalized** – A signalized RCUT intersection can provide favorable progression along an urban or suburban corridor. RCUT intersection signals typically require only two phases, which can minimize the loss time at the intersection. Efficient progression can be provided in both directions with any speed or signal spacing. Additional progression

advantages can be realized if there is more than one RCUT intersection along the corridor. Signalized RCUT intersections are able to easily accommodate pedestrians and adjacent access driveways. As there is a capacity limit for the cross street for signalized RCUT intersections, this option may not be appropriate at the intersection of two arterials.

- **Stop-controlled** – A stop-controlled RCUT intersection is sometimes used as a safety treatment at an isolated intersection on a four-lane divided arterial in a rural area. There are known safety benefits for this type of RCUT intersection. In some cases, a stop-controlled RCUT intersection is later converted to a signalized RCUT intersection as traffic volumes increase.
- **Merge- or yield-controlled** – A merge-controlled RCUT intersection can allow a rural high-speed divided four-lane corridor to function similar to a freeway corridor in cases where funding for interchanges and overpasses may not be readily available. This type of RCUT intersection relies on long distances to U-turn crossovers to allow for the weaving movement.

Hybrids of the three main types of RCUT intersections are possible and a RCUT intersection is sometimes converted from one type to another.

The RCUT intersection is similar to the MUT intersection. However, these alternative intersection types each have unique design features and are implemented at different locations with unique characteristics. The RCUT intersection reroutes minor street left-turn and through movements, while the MUT reroutes major street and minor street left-turn movements. The RCUT intersection typically has better signal progression than a MUT intersection, but does not serve minor street approaches with high through demand as well as the MUT intersection. The RCUT intersection may complement a corridor with MUT intersections by serving the corridors between the major intersections.

Restricted Crossing U-turn Informational Guide

Exhibits 1-1 through 1-3 illustrate examples of the three types of RCUT intersections.

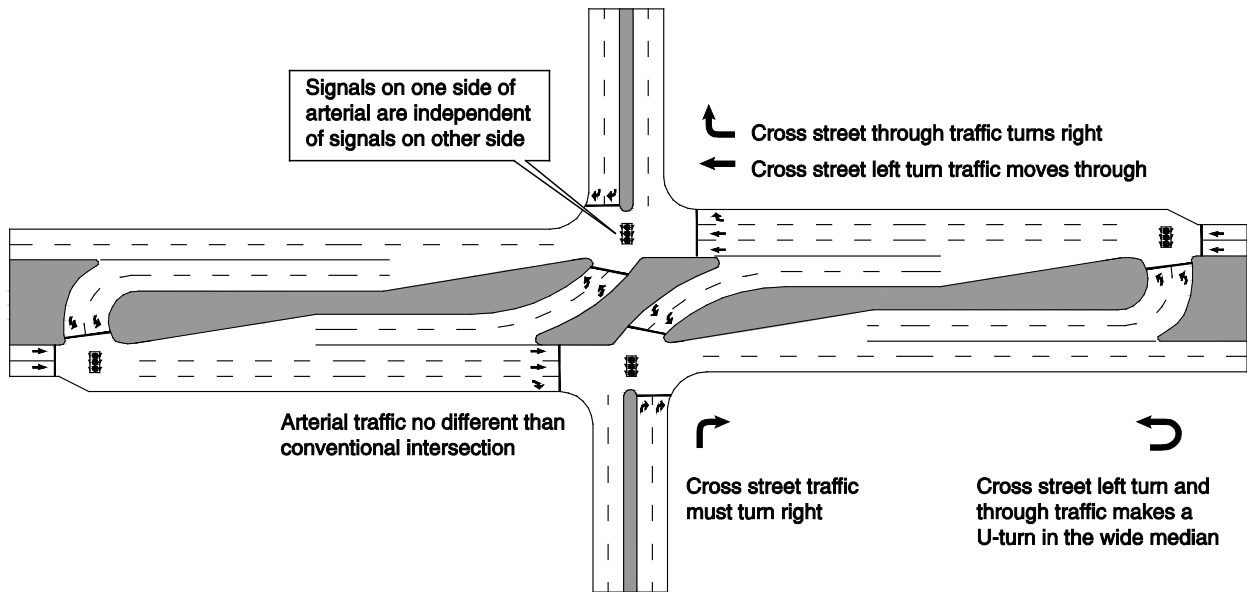

Exhibit 1-1. Example of a RCUT intersection with signals.

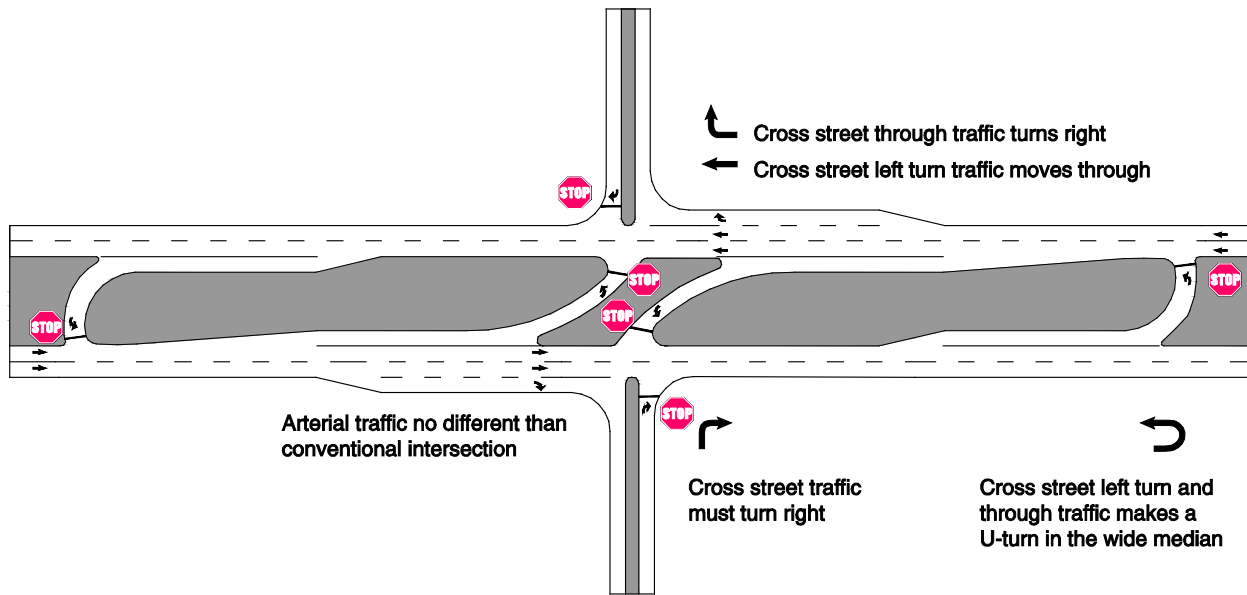

Exhibit 1-2. Example of a RCUT intersection with stop-control.

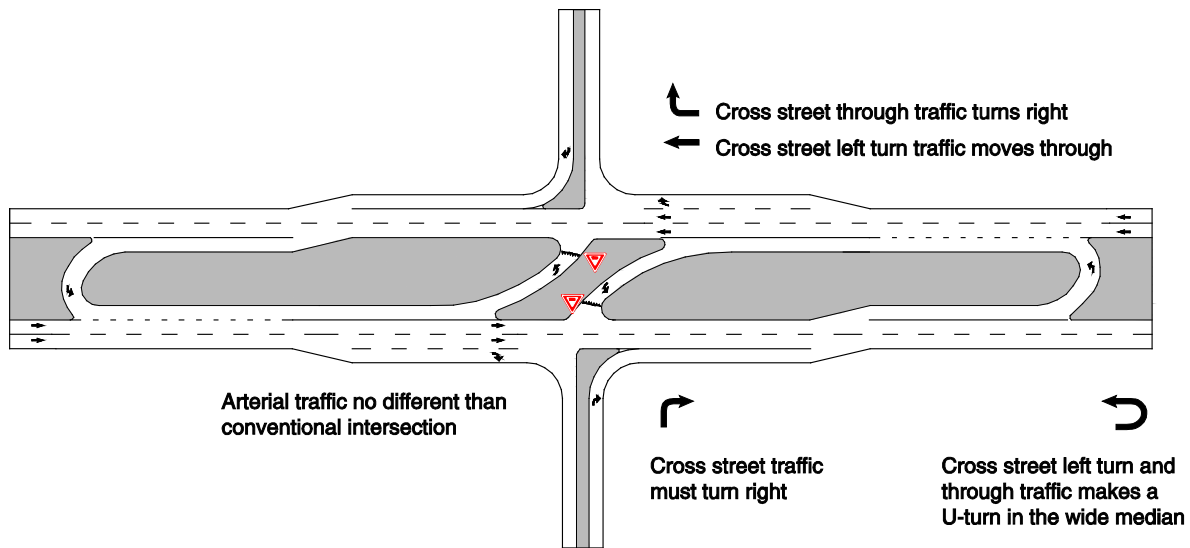

Exhibit 1-3. Example of a RCUT intersection with merges.

An intersection design like the RCUT, but without the major street left-turn crossovers, has been in use on urban arterials in North Africa, the Middle East, and the Indian subcontinent for years. For most of these intersections, the design operates without traffic signals, even with heavy traffic volumes. In these countries, the design helps to create adequate traffic flow, reduces conflicts, and reduces delay compared to uncontrolled intersections with similar demands.

The intersection design we now know as the RCUT intersection was first developed in the United States by Richard Kramer and was also developed independently in Maryland and North Carolina. Kramer published his concept in the mid-1980s.⁽¹⁾ Concerned with congestion on suburban arterials, Kramer developed a set of principles defining an ideal suburban arterial to overcome congestion and presented a design (he called it a “superstreet”) reflecting those ideals. The superstreet’s key design features include large, uninterrupted progression bands in both directions along the arterial and an arterial through movement that receives two-thirds to three-fourths of the green cycle. Kramer pursued his concept for years, and his influence eventually helped Alabama build RCUT intersections on US-231 in Dothan in the late 2000s.

Independently of Kramer, the Maryland State Highway Administration (MSHA) began developing concepts in as early as 1988 to address concerns related to maintaining adequate traffic flow on rural high-speed four-lane highways. At some minor road intersections along those highways, growing traffic volumes and conflicts created the potential need for traffic signals. However, MSHA was concerned signalization would reduce arterial mobility and attract more development (and minor street traffic) to the intersections. Instead of a signal, an unsignalized RCUT intersection (called a J-turn by MSHA) was used in some locations. The first J-turn was installed on US-15 near the Pennsylvania border and later on US-301 east of the Bay Bridge.

Another independent development of the RCUT intersection occurred in western North Carolina on a narrow, high-speed, four-lane highway through the mountains (US-23/74 near the Blue

Ridge Parkway). At this location, the North Carolina Department of Transportation (NCDOT) was attempting to mitigate an issue with conflicts from left-turning minor street traffic without installing signals. However, there was insufficient right-of-way to widen the median to create a refuge. The solution at this location was to install a series of RCUT intersections in 2000 that continue to operate effectively.

APPLICATION

Exhibit 1-4 shows the location of each existing RCUT intersection in the United States, as of the publication of this guide.

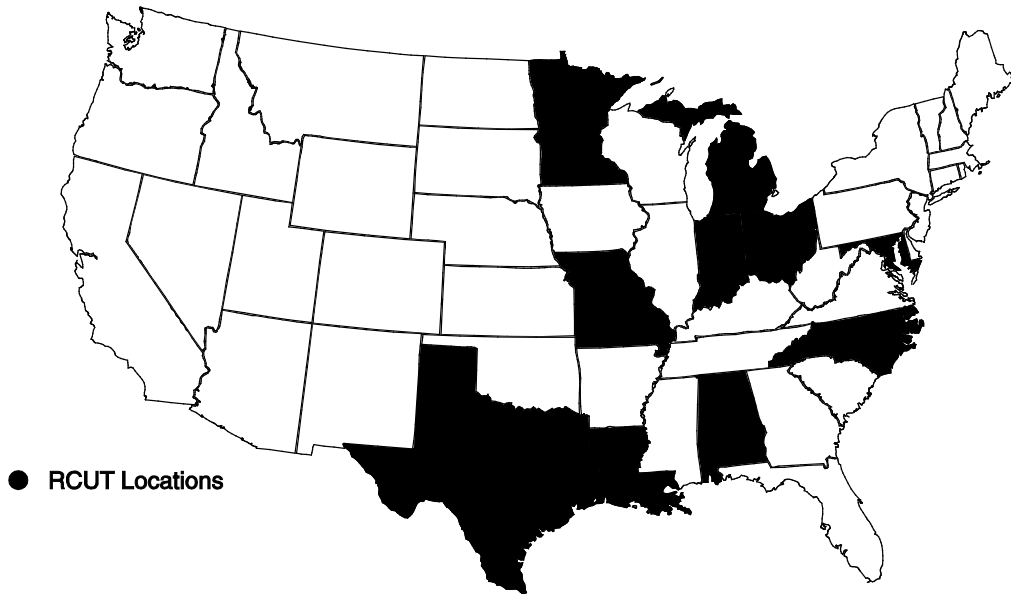

Exhibit 1-4. Locations of RCUT Intersections.

Exhibit 1-5 through Exhibit 1-12 feature photos of RCUT intersections that illustrate different contextual environments and a variety of design features.



Exhibit 1-5. Signalized RCUT intersection on US-281 in San Antonio, TX with four-lane major street and four-lane minor street.⁽²⁾



Exhibit 1-6. Stop-controlled RCUT intersection on US-1 near Southern Pines, NC.⁽²⁾



Exhibit 1-7. Merge-controlled RCUT intersection on US-15 in Emmitsburg, MD.⁽³⁾



Exhibit 1-8. RCUT intersection on US-15/501 in Chapel Hill, NC with no left-turn crossovers.⁽²⁾



Exhibit 1-9. Loon implemented on RCUT intersection in Wilmington, NC.⁽³⁾



Exhibit 1-10. Signaled RCUT intersection in operation near San Antonio, TX showing a pedestrian “Z” crossing.⁽³⁾



Exhibit 1-11. Three-legged RCUT intersection on US-17 at Brunswick Forest Parkway in Leland, NC.⁽²⁾



Exhibit 1-12. RCUT corridor on US-17 in Leland, NC.⁽⁴⁾

RESOURCE DOCUMENTS

This RCUT intersection guide is supplemental to major resource documents including but not limited to:

- *A Policy on Geometric Design of Highways and Streets* (American Association of State Highway and Transportation Officials [AASHTO] Green Book)⁽⁵⁾
- *Highway Capacity Manual* (HCM)⁽⁶⁾
- *Manual of Uniform Traffic Control Devices* (MUTCD)⁽⁷⁾

- *Highway Safety Manual (HSM)*⁽⁸⁾
- Other research documents that appear and are more specialized to specific areas of the guide include various National Cooperative Highway Research Program (NCHRP) reports, Transportation Research Board (TRB) papers, and Federal Highway Administration (FHWA) publications

The following supplemental resource documents related to the RCUT are also available:

- *Economic Effects of Access Management Techniques in North Carolina* by Cunningham, et al.⁽⁹⁾
- *Operational Effects of Signalized Superstreets in North Carolina* by Haley et al.⁽¹⁰⁾
- *Superstreet Benefits and Capacities* by Hummer et al.⁽¹¹⁾
- *Field Evaluation of a Restricted Crossing U-turn Intersection* by Inman and Haas.⁽¹²⁾
- *Safety Effects of Unsignalized Superstreets in North Carolina, Accident Analysis and Prevention* by Ott et al.⁽¹³⁾
- *Evaluation of J-turn Intersection Design Performance in Missouri*, by Edara, et al.⁽¹⁴⁾

CHAPTER 2— POLICY AND PLANNING

This chapter contains guidance on how to consider alternative intersections in general and RCUT intersections in particular. This chapter summarizes policy and planning considerations related to RCUT intersections. The remaining chapters of this guide will provide specific details of the multimodal, safety, operations, geometric design, and traffic control features of RCUT intersections.

Alternative intersections are often initially considered for operational or safety needs, and other key factors may include spatial requirements and multimodal needs. This chapter provides approximate footprints for different types of RCUT intersections to allow for planning-level screening and feasibility analysis.

PLANNING CONSIDERATIONS FOR ALTERNATIVE INTERSECTIONS AND INTERCHANGES

Alternative intersection evaluations may vary depending on the stage of the project development process. Each project stage can affect how the policy and technical considerations are assessed. While the operational aspects, design, safety, human factors, and signing controls are considered at every stage of the development process, a planning-level design evaluation may not require the same level of analysis or detailed evaluation of each consideration as projects in later development stages. Evaluations may vary but should generally be as comprehensive as needed to answer key project questions for each unique project context.

Serving Pedestrians and Bicycles

The unique geometrics and traffic control at a RCUT intersection can introduce both benefits and challenges to pedestrians and bicyclists. Integrating pedestrian and bicycle needs at an early stage of the project planning process, rather than simply incorporating these elements in the latter stages of design, yields a higher quality solution.

A RCUT intersection reduces the total number of vehicle-pedestrian conflict points compared to a conventional intersection, creates shorter and more direct paths at some pedestrian crossings, and—at a signalized RCUT intersection—pedestrians will be able to use a larger portion of the cycle. A RCUT intersection also provides opportunities for additional mid-block crosswalks, particularly at the U-turn crossovers.

At a RCUT intersection, the layout of pedestrian crossings may be quite different from most other intersection designs (including other alternative intersections), so details related to navigation for visually impaired pedestrians are critical. Some paths for crossing pedestrians are longer than at a conventional intersection, and some crossing movements will require pedestrians to wait in the median. Accommodating bicycles at an RCUT, as with any intersection, begins with the decision about whether or not to provide exclusive bicycle facilities, including marked and buffered bike lanes, off-road shared-use paths, shoulder accommodations, etc. Once this decision is made, the RCUT design must properly accommodate the ability of bicyclists to navigate through or turn at the intersection. The unique geometry and channelization of an

RCUT may necessitate bicycle movements that are dissimilar from motor vehicle movements. Chapter 3 provides more detail on multimodal design options.

Traffic Volume Relationships

Exhibit 2-1 conceptually depicts the relationship of conventional intersections, alternative intersections, and grade separations in their ability to serve increasing traffic volumes.

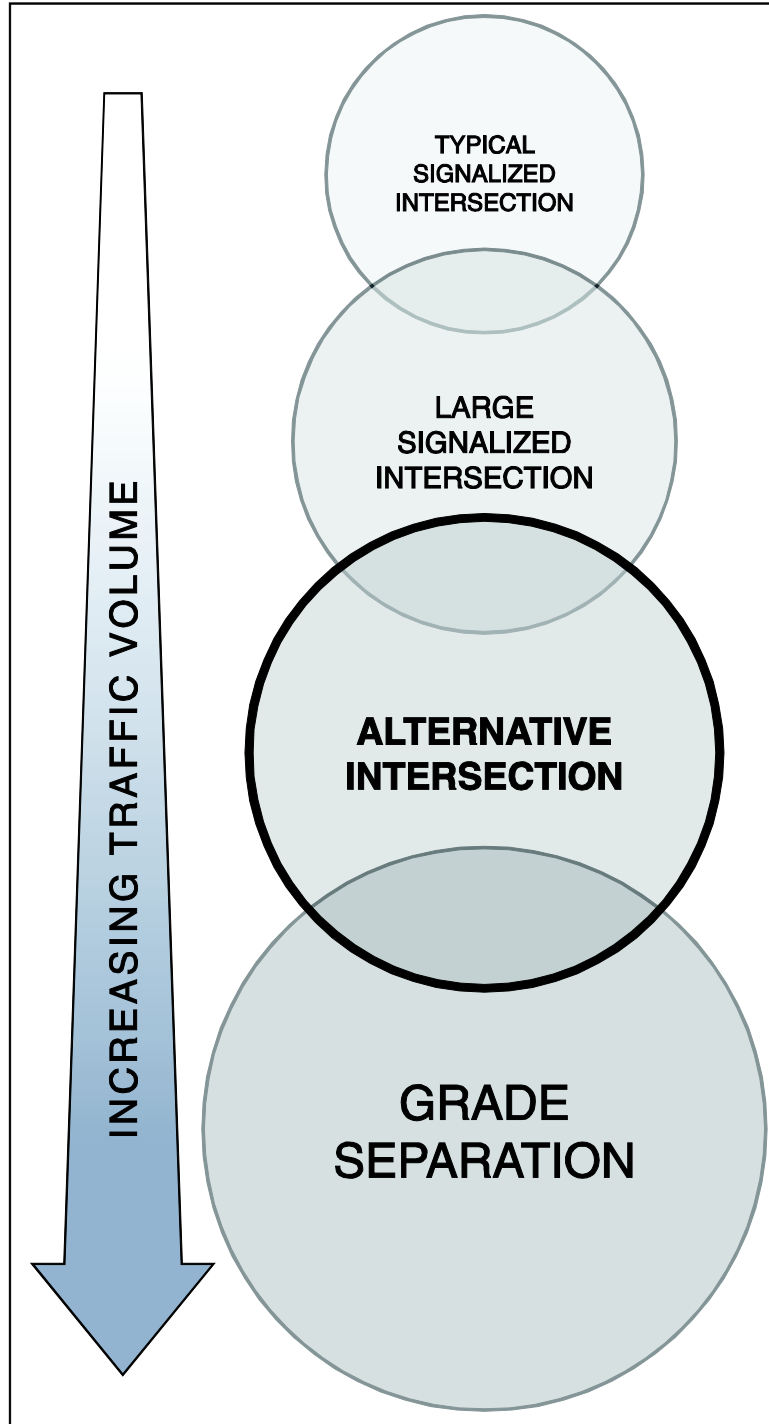

Exhibit 2-1. Relationship between total entering volume and intersection type.

STAKEHOLDER OUTREACH

Similar to other transportation projects, stakeholder outreach is a critical part of the overall planning process. Successfully implementing the first RCUT intersection in a community may

benefit from explicit and proactive outreach and education to affected stakeholders and the general public. This would create opportunities to familiarize others with how the intersections work while creating opportunities to hear of general project and RCUT intersection specific issues and considerations. Creating multiple forums to engage the public (including presentations at local council or board meetings, briefs at community organization functions, and project-specific open house meetings) results in opportunities to listen to community interests and share objective information about the intersection form.

Media campaigns through local newspapers, television, and public meetings can be effective methods of keeping the community informed. Exhibit 2-2 is an example of an informational map used by NCDOT for explaining RCUT intersections (superstreet intersections) to drivers. Stakeholder outreach should also target other users including pedestrians and bicyclists. Once the intersection is open to the public, monitoring driver behavior and using law enforcement as necessary to promote proper use of the new form can aid driver acclimation.

Benefits of Superstreets

- Safety
- Time savings
- Increased capacity
- Access Management
- Improved traffic flow
- Land use and corridor protection
- Alternative to interchange (Less cost)
- Smaller "footprint" than an interchange

Strategic Highway Corridors

The superstreet alternative improves mobility as a step-by-step process by bringing us one step closer to a freeway/expressway.

The North Carolina Department of Transportation (NCDOT) in collaboration with the Department of Commerce and Department of Environment and Natural Resources has established a "vision" for 5,400 miles of highway along 55 corridors throughout the state. Its primary purpose is "to provide a network of high-speed, safe, reliable highways throughout North Carolina."

<http://www.ncdot.gov/~shc>

<http://www.ncdot.gov/~superstreet>

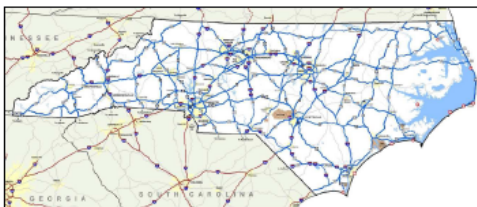

For more information, please contact:

North Carolina Department of Transportation

1-800-DOT-4YOU

www.ncdot.gov

Conventional Intersection

The North Carolina Department of Transportation (NCDOT) is challenged to try non-traditional approaches to relieving congestion and improving safety in heavily developing areas. The superstreet is a non-traditional option the NCDOT has found beneficial. Congestion on urban and suburban arterials is an imminent consequence of developing regions of the state. Conventional intersections can create added congestion and long queues resulting in increasing delays in travel time due to the increased traffic flow.



Superstreet

A superstreet is a type of intersection in which side-street traffic is redirected from going straight through or left at a divided highway intersection. All side-street traffic must turn right, but can then access a U-turn to proceed in the desired direction. Other configurations of superstreets are possible based on site specific conditions.

The Superstreet concept provides an effective alternative along heavily traveled regional arterials in areas with anticipated commercial and residential growth. The design concept is contingent upon a series of features that reduce potential conflict points while maintaining traffic flow, resulting in:

- Increased safety by reducing conflict points at major crossovers
- Time savings from simplified signal phasing
- Enhanced signal coordination
- Dedicated U-turn lanes for efficiency



North Carolina Department of Transportation



"Connecting people and places in North Carolina - safely and efficiently, with accountability and environmental sensitivity."



SUPERSTREETS

A tool for safely and efficiently managing congestion

Left turn movement

The conventional intersection allows left turn movements from side streets creating numerous conflict points. The superstreet reduces conflict points therefore increasing safety.

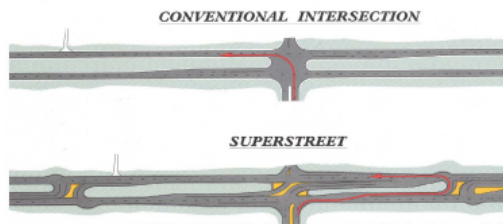

Through movement

The conventional intersection allows through movements onto side streets, creating numerous conflicts points. The superstreet intersection prohibits through movements onto side streets forcing a right turn movement onto the arterial, then a U-turn back onto the arterial to safely

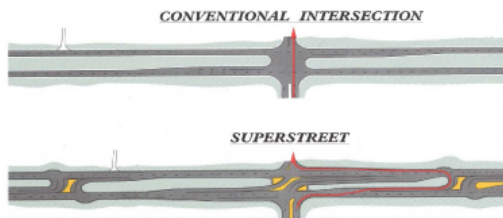

Exhibit 2-2. Superstreet intersection public brochure from NCDOT.⁽⁴⁾

NCDOT has developed a graphic to provide additional information and visuals for users of the superstreet intersection, as shown in Exhibit 2-3.

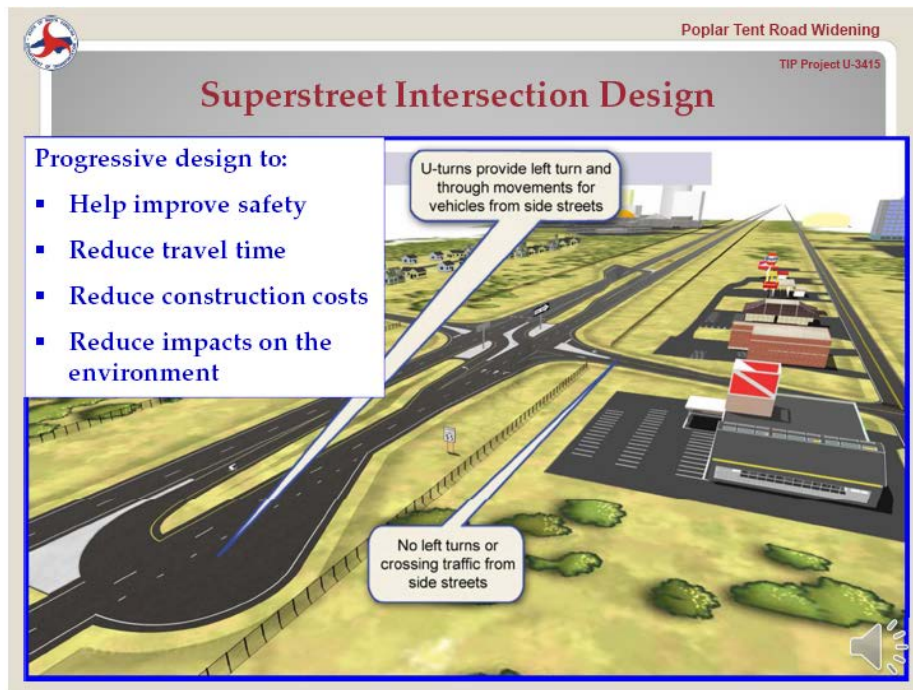

Exhibit 2-3. Superstreet intersection graphic by NCDOT.⁽¹⁵⁾

Videos are another helpful tool for public outreach and user education implemented by many agencies to demonstrate RCUT intersections. Some of the videos are developed through simulation tools, and others may show a road view to illustrate what drivers may expect when they travel through this type of intersection. Exhibit 2-4 illustrates multiple screen shots from a simulation video used by the Minnesota Department of Transportation (MnDOT). Exhibit 2-5 shows screen shots from a video used by MnDOT to demonstrate a school bus and heavy vehicle using a RCUT intersection.

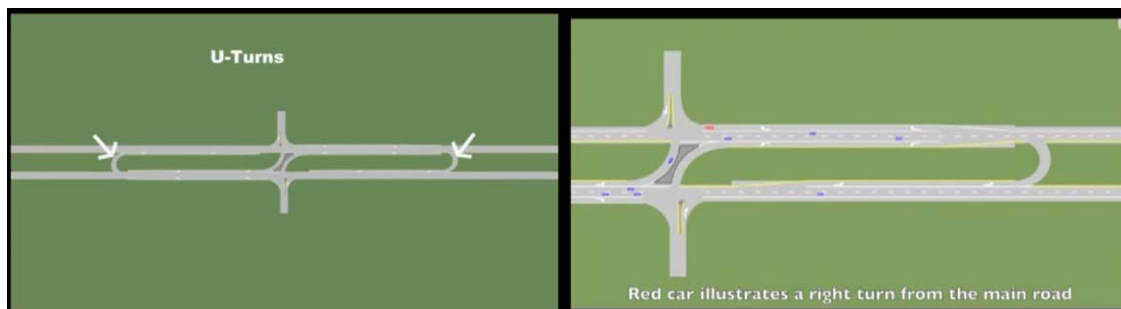

Exhibit 2-4. Reduced conflict intersection video by MnDOT.⁽¹⁶⁾



Exhibit 2-5. J-Turn intersection video by MoDOT.⁽¹⁷⁾

FHWA has created alternative intersection and interchange informational videos and video case studies, which can be viewed on the FHWA YouTube channel (<https://www.youtube.com/user/USDOTFHWA>).⁽¹⁸⁾ In addition, FHWA has developed alternative intersection brochures that can be found on the FHWA website (<http://safety.fhwa.dot.gov>).⁽¹⁹⁾ Examples of this information are shown in the appendix.

POLICY CONSIDERATIONS

Designing, operating, and managing a street and its intersections should align with the appropriate jurisdictional policies associated with that facility. The facility location and type can often dictate the appropriateness of the right-of-way and access management needs associated with alternative intersections. The degree to which motor vehicle throughput should or should not be prioritized over other modes also plays a role in determining the appropriateness of alternative intersections at specific locations.

Some of the policy considerations that should be addressed while planning and designing a RCUT intersection include:

- Access management
 - Typical, minimum, and maximum U-turn crossover spacing
 - Driveway spacing or signal spacing criteria
- Operational measures of effectiveness
- If signalized, acceptable cycle lengths, progression speeds, and progression bandwidths
- Design vehicles in crossovers
- Pedestrian facilities with access and wayfinding for persons with disabilities, including the requirements of the Americans with Disabilities Act (ADA) and Section 504 (the Rehabilitation Act)⁽²⁰⁾

- Bicycle facilities
- Snow removal and storage
- Incident management
- Emergency response needs

The RCUT intersection is a corridor treatment for an arterial and is not typically needed on collectors or local streets. This intersection type is not typically suitable for an intersection of two arterials. RCUT intersections with stop-control or merges are typically used as safety treatments or as an interim treatment at an isolated intersection on rural high-speed four-lane arterials. While signalized RCUT intersections may be used at isolated intersection locations, a corridor treatment with multiple installations in an urban or suburban area can provide the most efficient progression benefits.

Access management considerations when reviewing potential RCUT intersection installations, are listed below:

- Access management particularly applies to signalized RCUT intersections. However, as many unsignalized RCUT intersections eventually become signalized, access should be considered in all types of RCUT intersections.
- RCUT intersections can provide opportunities for adjacent driveways and side streets. There are also opportunities for a driveway at the end of a U-turn crossover.
- RCUT intersection designs have significant flexibility with locating the crossover. Crossovers can be moved within generous limits to accommodate access needs. Crossover spacing is typically based on signal visibility and queuing.
- RCUT intersections provide significant progression benefits along a corridor, which can allow for speed control using the signals. Areas with multiple access points and high pedestrian activity may choose to use lower speeds.
- RCUT intersection corridors can accommodate more signals than a conventional intersection corridor, while still producing lower through vehicle delays, due to the efficient progression of the signalized RCUT intersections. This allows agencies to provide signalized driveways and crossovers for various types of development.

PLANNING CONSIDERATIONS

The following are planning considerations for alternative intersection design:

- **Community goals** – Outside of formalized land use policies, cities and communities often have general goals that provide insights about the nature and character of their community. These goals can range from concepts that preserve a historic character or identified heritage to creating walkable communities or complete streets. Other goals can

be to encourage economic development by preserving existing business or residential areas while encouraging thoughtful development. Regardless of the specific goals or vision, these considerations may influence street and intersection design.

- **Surrounding land uses and zoning** – RCUT intersections are well suited for any type of zoning or surrounding land uses. RCUT intersections could particularly provide benefit on a main street through a dense downtown area.
- **Project context** – Key questions that help to identify stakeholders for a particular project might include:
 - What is the purpose and function of the existing or planned road facilities?
 - What are the existing and planned land uses adjacent to and in the vicinity of the road facilities?
 - Who will likely desire to use the road facilities given the existing and planned land uses?
 - What are the existing and anticipated future socio-demographic characteristics of the populations adjacent to and in the vicinity of the existing or planned road facilities?
 - What are the perceived or actual shortcomings of the existing road facilities?
 - Who has jurisdiction over the facility?
 - Where is capital funding for the project originating (or expected to originate)?
 - Who will operate and maintain the facility?
- **Multimodal considerations** – Pedestrian, bicycle, and transit needs should play a role in selecting an intersection form and the developing design elements of the intersection.
- **Design vehicles** – The intersection geometry will need to accommodate transit, emergency vehicles, freight, and potentially oversize and overweight (OSOW) vehicles.
- **Types of RCUT intersections** – Stop-controlled RCUT intersections are typically used as a safety countermeasure, RCUT intersections with merges are often used as an interim measure instead of implementing an interchange, and RCUT intersections with signals are an arterial corridor treatment.
- **Kramer’s Arterial Theory** – Kramer’s arterial theory describes the goal of wide and continuous progression bands along an arterial at a desirable speed in both directions of the corridor. In some cases, adjusting the lead and lag left-turn phases at conventional signals can allow those desired progression bands. Signalized RCUT intersections are needed where conventional signals with lead and lag left turns do not provide sufficient bandwidths.

- **Side street demand** – A signalized RCUT intersection has a side street demand limit of approximately 25,000 vehicles per day (vpd), which is derived from HCM calculations. This assumes a U-turn crossover accommodates the minor street left-turn and through movement, the crossover is a maximum of two lanes, and the crossover uses no more than one-third of the signal cycle.
- **CAP-X** – CAP-X is a suitable tool for evaluating a RCUT intersection capacity at a planning level. Additional information on CAP-X can be found in the Appendix.
- **RCUT and other alternative intersections** – RCUT intersections have the potential to complement other alternative intersections such as MUT or DLT intersections. A signalized RCUT intersection is typically used along a corridor, while MUT and DLT intersections are often used in high-demand locations. MUT and DLT intersections can provide good progression, but not as favorable as the RCUT intersection, particularly in both directions of the corridor.

PLANNING CHALLENGES

The following are several challenges associated with planning RCUT intersections:

- **Driver education** – Successful implementations of alternative intersections are often preceded by public outreach and education campaigns, which are typically not conducted for conventional intersection improvements.
- **Driver expectation** – Alternative intersections relocate one or more movements from their conventional location, potentially resulting in driver confusion. However, a RCUT intersection is typically easier to navigate than a MUT or DLT intersection since major street drivers follow the same path as a conventional intersection and minor street vehicles are only given the choice to turn right at the main junction.
- **Multimodal facilities** – As with any street segment or intersection, each configuration must consider and serve the various users who currently or may be expected to use the facilities. This should always include pedestrians and bicycles, understanding that the exact provisions may necessarily vary from site to site. However, pedestrian facilities must always be made accessible. RCUT intersections are generally compatible with transit as well.
- **Sufficient corridor right-of-way** – Some alternative intersections can have a larger overall footprint or require more right-of-way in certain areas compared to an equivalent conventional design. Although RCUT intersections generally are known to have wide medians, they can also work with narrower medians when bump-outs or “loons” are used to accommodate U-turn crossovers. There is flexibility in locating the U-turn crossover, allowing agencies to minimize the right-of-way cost of loons.
- **Emergency vehicle use and fire or ambulance station location** – Emergency vehicles operating along the main street at a RCUT intersection or serving a crash on the RCUT intersection are not expected to have concerns. However, vehicles responding from an

emergency station along the minor street near a RCUT intersection would likely experience delay.

PROJECT PERFORMANCE CONSIDERATIONS

Measuring the effectiveness of overall project performance depends on the nature or catalyst for the project. Understanding the intended specific operational, safety, and geometric performance context for each intersection or corridor, including intended users, guides project assessments. The project performance may be directly linked to the specific design choices and performance of the alternatives considered. The project performance categories described below can influence and are influenced by the specific RCUT intersection design elements and their characteristics.⁽²¹⁾

Accessibility

Chapter 3 of this guide describes accessibility as it relates to special consideration given to pedestrians with disabilities including accommodating pedestrians with vision or mobility impairments. However, for the purposes of considering a project's general context and the performance considerations, the term "accessibility" goes beyond the conversation of policy related to ADA and Public Rights-of-Way Accessibility Guidelines (PROWAG) and is meant to be considered in broader terms.⁽²²⁾ With respect to considering applicable intersection forms for a given project context, accessibility is defined broadly as the ability to approach a desired destination or potential opportunity for activity using highways and streets (including the sidewalks and/or bicycle lanes provided within those rights-of-way). This could include the ability for a large design vehicle to navigate an intersection as much as it might pertain to the application of snow mobiles or equestrian uses in some environments or conditions.

Mobility

Mobility is defined as the ability to move various users efficiently from one place to another using highways and streets. Mobility can sometimes be associated with motorized vehicular movement and capacity. For the purposes of this guide, mobility is meant to be independent of any particular travel mode.

Quality of Service

Quality of service is defined as the perceived quality of travel by a road user. It is used in the *2010 Highway Capacity Manual* to assess multimodal level of service for motorists, pedestrians, bicyclists, and transit riders. Quality of service may also include the perceived quality of travel by design vehicle users such as truck or bus drivers.

Reliability

Reliability is defined as the consistency of performance over a series of time periods (e.g., hour-to-hour, day-to-day, year-to-year).

Safety

Safety is defined as the expected frequency and severity of crashes occurring on highways and streets. Expected crash frequencies and severities are often disaggregated by type, including whether or not a crash involves a non-motorized user or a specific vehicle type (e.g., heavy vehicle, transit vehicle, motorcycle). In cases where certain crash types or severities are small in number, as is often the case with pedestrian- or bicycle-involved, it may be necessary to review a longer period of time to gain a more accurate understanding.

PROJECT DEVELOPMENT PROCESS

For the purposes of this guide, the project development process is defined as consisting of the stages described below. Federal, state, and local agencies may have different names or other nomenclature with the overall intent of advancing from planning to implementation. Exhibit 2-6 illustrates the overall project development process.

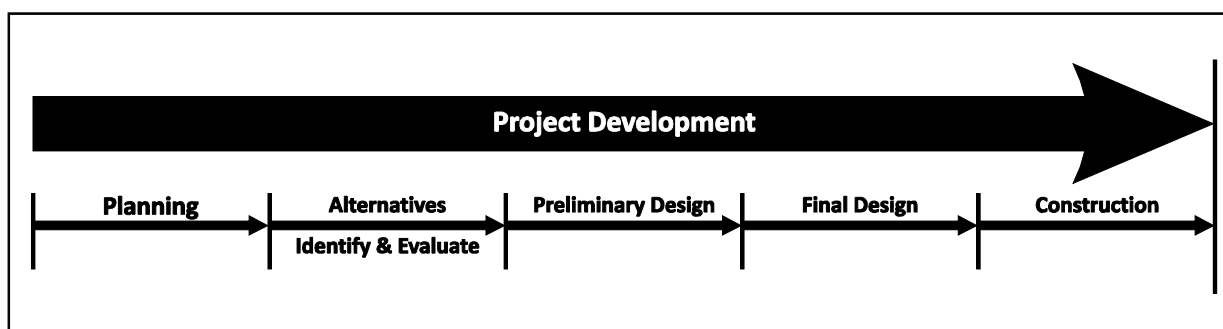

Exhibit 2-6. Project development process.

Planning Studies

Planning studies often include exercises such as problem identification and other similar steps to ensure there is a connection between the project purpose and need and the geometric concepts being considered. Planning studies could include limited geometric concepts on the general type or magnitude of project solutions to support programming.

Alternatives Identification and Evaluation

The project needs identified in prior planning studies inform concept identification, development, and evaluation. At this stage, it is critical to understand the project context and intended outcomes so potential solutions may be tailored to meet project needs within the opportunities and constraints of a given effort. FHWA describes context sensitive solutions as “... a collaborative, interdisciplinary approach that involves all stakeholders in providing a transportation facility that fits its setting.”⁽²³⁾ In considering the concept of “context sensitive design/solutions,” this stage calls for meaningful and continuous stakeholder engagement to progress through the project development process.

Preliminary Design

Concepts advancing from the previous stage are further refined and screened during preliminary design. For more complex, detailed, or impactful projects, the preliminary design (typically 30-percent design level plans) and subsequent documentation are used to support more complex state or federal environmental clearance activities. The corresponding increased geometric design detail allows for refined technical evaluations and analyses that inform environmental clearance activities. Preliminary design builds upon the geometric evaluations conducted as part of the previous stage (alternatives identification and evaluation). Some of the common components of preliminary design include:

- Horizontal and vertical alignment design
- Typical sections
- Grading plans
- Structures
- Traffic/intelligent transportation systems (ITS)
- Signing and pavement markings
- Illumination
- Utilities

Final Design

The design elements are advanced and refined in final design. Typical review periods include 60-percent, 90-percent, and 100-percent plans before completing the final set of PS&E. During this stage, there is relatively little variation in design decisions as the plan advances to 100-percent. Functionally, in this stage of the project development process, the targeted performance measures have a lesser degree of influence on the form of the project.

Construction

Construction may be related to temporary streets, connections, or conditions that facilitate construction. Project performance measures may relate to project context elements.

SUMMARY OF RCUT ADVANTAGES AND DISADVANTAGES

As described in Chapter 1 and the previous sections of this chapter, RCUT intersections have unique features and characteristics, including multimodal considerations, safety performance, operations, geometric design, spatial requirements, constructability, and maintenance.

Exhibit 2-7 provides an overview of the primary advantages and disadvantages of RCUT intersections for users, policy makers, designers, and planners to understand when considering this type of alternative intersection form.

Restricted Crossing U-turn Informational Guide

Exhibit 2-7. Summary of RCUT intersection advantages and disadvantages.

	Advantages	Disadvantages
Non-motorized users	<ul style="list-style-type: none"> • Reduces conflicts between vehicles and pedestrians for most crossing movements • Creates shorter pedestrian crossing distance for some movements • Creates opportunities to install mid-block signalized crossings in many places along an arterial 	<ul style="list-style-type: none"> • Increases conflicts between vehicles and pedestrians for some crossing movements • Creates longer pedestrian crossing distances for some movements, which could add delay and reduce convenience • Requires pedestrians to cross in two stages in some cases, which could add delay and reduce convenience • Overall pedestrian wayfinding may require additional signs and other features to create appropriate crossings for pedestrians of all abilities • Provisions for bicycle facilities may be very different from conventional intersections, and may result in reduced convenience.
Safety	<ul style="list-style-type: none"> • At rural four-lane sites, reduces crashes, injuries, and fatalities • Reduces turning and angle crashes • Reduces vehicle-pedestrian conflict points 	<ul style="list-style-type: none"> • Increases sideswipe crashes • Increases travel distances which could lead to more crashes that are related to distance traveled, such as animal and run-off-road crashes
Operations	<ul style="list-style-type: none"> • Creates the possibility for the largest possible progression bands in both directions of the arterial at any speed with any signal spacing • Provides potential to reduce overall travel time at signalized sites • Provides potential to reduce delay and travel time for arterial through traffic at signalized sites • Provides potential for shorter signal cycle lengths • Allows larger portion of signal cycle to be allocated to the arterial through movement • Reduces the need for signalization of intersections along rural, high-speed, divided highways 	<ul style="list-style-type: none"> • Increases travel distance (and potentially travel time) for minor street left turn and through movements • Experiences a firm capacity • Creates potential for spillback out of crossover storage lane • Minor street left turn and through drivers must make unusual maneuvers and may need additional guidance
Access management	<ul style="list-style-type: none"> • Provides multiple driveway or side street locations along the RCUT corridor • Signals for driveways or side streets may be installed without introducing significant extra delay for arterial through movement • Allows flexibility for crossover locations to accommodate adjacent driveways and side streets • Does not require frontage roads 	<ul style="list-style-type: none"> • Does not allow driveway or side street near entrance to U-turn crossover • Landowners will not have driveways with direct left turns out of their properties

Restricted Crossing U-turn Informational Guide

	Advantages	Disadvantages
Traffic calming	<ul style="list-style-type: none"> • Two-way progression capabilities provide the opportunity to set any progression speed (even low speed) • Provides an additional barrier to fast minor street through traffic across arterial 	<ul style="list-style-type: none"> • The additional barrier to direct minor street through traffic across arterial could be a concern for communities that straddle the arterial and desire direct vehicle connections
Space	<ul style="list-style-type: none"> • The greater arterial throughput creates possibility to reduce the basic number of through lanes on the arterial and achieve similar service levels 	<ul style="list-style-type: none"> • May require additional right-of-way for loons or wider medians
Maintenance	<ul style="list-style-type: none"> • Less queuing on the arterial may reduce pavement rutting and wear 	<ul style="list-style-type: none"> • When signalized, there are more signal controllers and cabinets than a comparable conventional intersection • There are more signs than a comparable conventional intersection • If designed with a larger median, there is more to maintain than a comparable conventional intersection • More pavement to maintain in U-turn crossovers and loons
Aesthetics	<ul style="list-style-type: none"> • Median and islands provide opportunity for landscaping 	

CHAPTER 3—MULTIMODAL CONSIDERATIONS

This chapter provides an overview of multimodal facilities at RCUT intersections and how provisions for pedestrians and bicycles should influence the overall planning and design of these intersections. Several of the guidelines presented here are based on elements of the AASHTO Green Book, but applied within the unique context of a RCUT intersection.⁽⁵⁾ The overall objective is to develop a design, regardless of the type of intersection, compatible with a Complete Street. A Complete Street is a facility that serves many types of users including freight, transit, and non-motorized users.

DESIGN PRINCIPLES AND APPROACH

A RCUT intersection has the potential to deliver more safety and efficiency benefits to motor vehicles than a comparable conventional intersection in some contexts. With proper design, a RCUT intersection can also benefit users of other modes, especially pedestrians, bicyclists, and transit passengers. The RCUT intersection is an adaptable design that can be effective in rural setting as well as in urban settings where the objectives are to provide a suitable environment for pedestrians, bicyclists, and transit users while moving vehicles at an appropriate speed.

- Signalized RCUT forms can be used in various land use settings to meet the need of a variety of modal users
- Unsignalized RCUT forms may also serve a variety of users, including farm equipment in rural areas. Some unsignalized RCUT intersections in Minnesota have slightly depressed channelizing islands to allow farm equipment to directly make a minor street through movement

RCUT intersection planning and design should consider the variety of transportation modes using the intersection. The following elements should be evaluated when considering a RCUT intersection:

- RCUT intersections may be unfamiliar for many users. Pedestrians and bicyclists will need to learn how to use or cross the intersection. Both the intersection's geometry and traffic control devices can help pedestrians and bicyclists to navigate the intersection safely and effectively.
- The RCUT may have a wider median and reduced number of traffic signal phases compared to a conventional intersection, which can introduce both benefits and challenges to pedestrians, bicyclists, transit passengers, and persons with disabilities.
- Large vehicles require adequate paved areas to accommodate their swept paths. Therefore, the geometry of the intersection and all its associated movements need to accommodate the design vehicle for the facility.
- RCUT intersections may be designed with merges on high-speed rural four-lane highways as an alternative to an interchange or overpass. In these cases, designers should expect heavy vehicles.

This chapter describes the unique characteristics of the four primary non-auto modes (pedestrians, bicyclists, transit, and heavy vehicles) that should be considered when analyzing and designing RCUT intersections. Understanding and identify the various users and their needs within the RCUT configuration will guide planning and design decisions at a given intersection location.

PEDESTRIANS

RCUT intersections require pedestrian crossings that differ from conventional intersections. More movements are unsignalized, and there are a greater percentage vehicles turning right. The RCUT intersection's wide geometric footprint can make it challenging to accommodate pedestrians but the short cycle lengths associated with RCUT intersection operations can help make pedestrian movements more comparable to crossing times at conventional intersections.

Pedestrian crossings at RCUT intersections must be accessible for all users, including those with visual impairments. Therefore, the provisions for pedestrians must take into account the need to communicate crossing patterns in non-visual ways, using wayfinding techniques that are discussed in the PROWAG.⁽²²⁾ This may include audible devices, channelization, and separation and detectable delineation of the pedestrian route and crossing.

At this time, the most common means of serving pedestrians at a RCUT intersection is a "Z" crossing treatment. Exhibit 3-1 shows a "Z" crossing treatment.

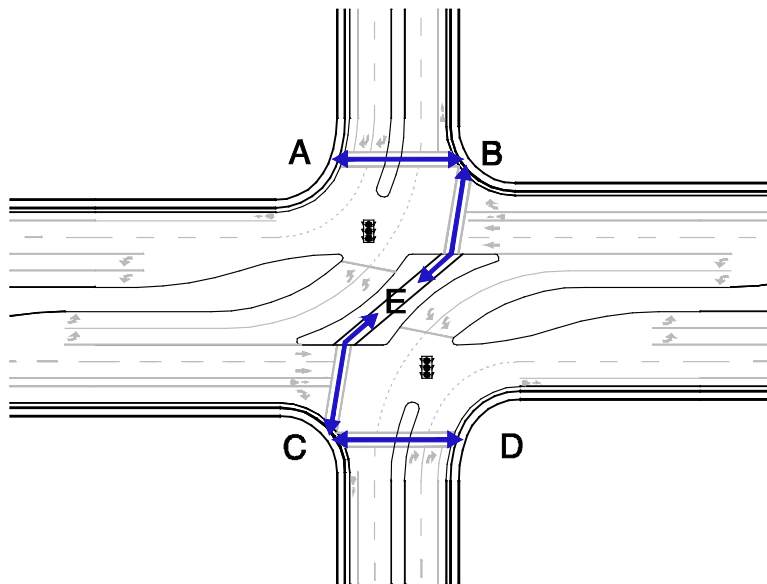

Exhibit 3-1. Pedestrian movements in a RCUT intersection.

A "Z" crossing allows all six desired pedestrian movements at an intersection. The two minor street crossings (A to B, C to D) are made similarly to a conventional intersection. Three of the movements (A to C, B to D, and A to D) require pedestrians to take a longer, unconventional route. The sixth movement (B to C) requires pedestrians to take a shorter, unconventional route.

Unintended crossing routes (A to C directly, B to D directly) should be discouraged through the use of buffer treatments. Exhibit 3-2 shows a “Z” crossing at a signalized RCUT intersection near San Antonio, TX.

The major road crossing distance could be shortened by adding a raised barrier or channelization between major street through lanes and major street right turn lanes.



Exhibit 3-2. Signalized RCUT with “Z” crossing near San Antonio, TX.⁽³⁾

Pedestrians using the “Z” crossing at a RCUT intersection encounter fewer conflicting traffic streams than at a conventional intersection. At a conventional intersection, pedestrians cross the entire street width during the vehicle phase of the parallel road. Exhibit 3-3 shows the traffic movements and conflict points that pedestrians experience at a conventional intersection.

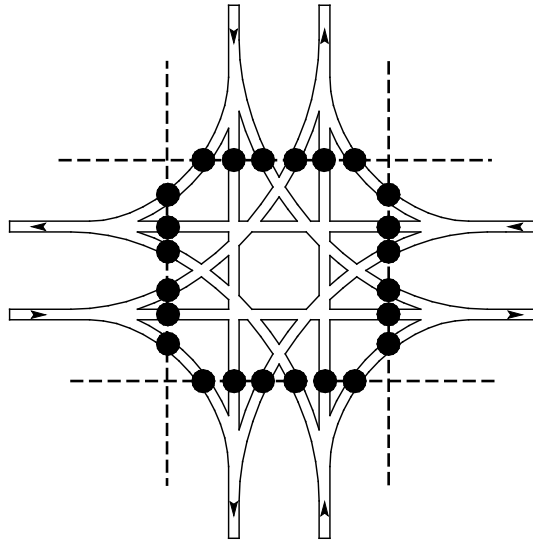

Exhibit 3-3. Pedestrian-vehicle conflict points at conventional intersection.

In comparison, Exhibit 3-4 shows the pedestrian conflict points with a RCUT intersection design. At a RCUT intersection, the left turns are removed from the minor street and occur away from the intersection, thus removing potential pedestrian exposure to left-turning vehicles. However, the volume of vehicles turning right to the minor street is higher than at a conventional intersection.

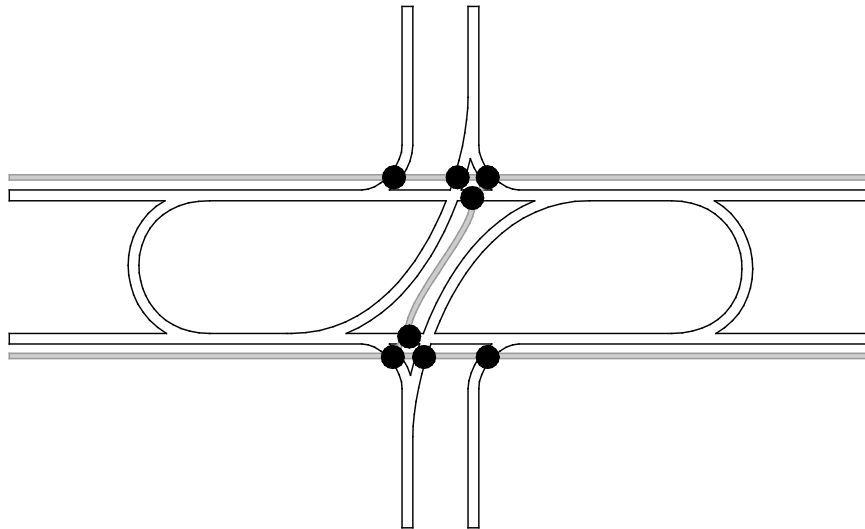

Exhibit 3-4. Pedestrian-vehicle conflict points at RCUT intersection.

A RCUT intersection reduces the number of vehicle-pedestrian conflict points from 24 to 8 using a “Z” crossing. Movements requiring a longer unconventional route or having more conflict points may tempt some pedestrians to directly cross the major street (i.e., C to A or B to D), or cross from the center diagonal island (E) to one of the alternate quadrants (i.e., A or D). Several

options, described in the next section, can be considered for discouraging undesirable pedestrian crossings.

Additional Crossing Options

Exhibit 3-5 shows a variation of the RCUT intersection design in which the minor street approaches are offset to allow a perpendicular pedestrian crossing of the major street. This has a minimal impact on vehicle operations at most RCUT intersections. A shorter crossing distance decreases the pedestrian exposure to moving vehicles on the major street. Wayfinding signing and other devices would be needed to direct pedestrians to the crossing locations and deter them from crossing at the minor street intersections. This minor street offset design is typically not feasible where streets already exist, but in a developing area where minor street or driveway locations have not been established this variation should be strongly considered.

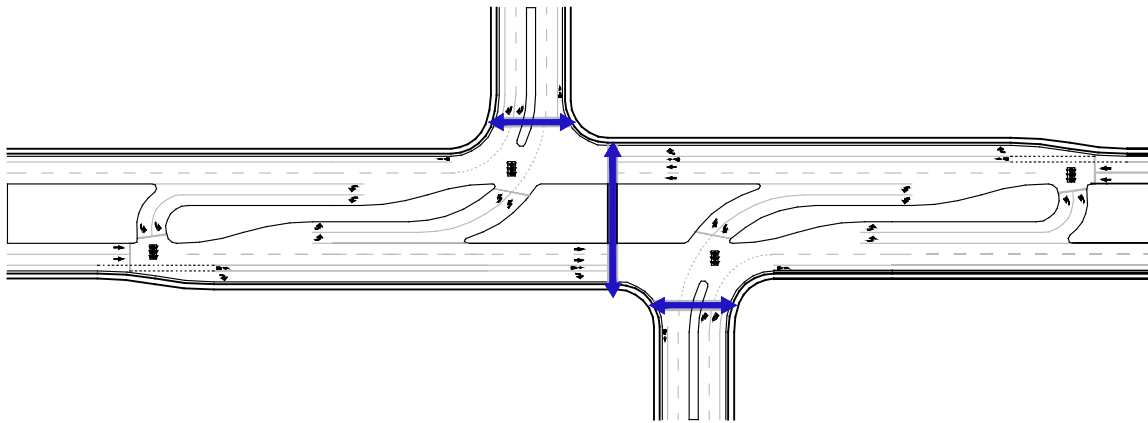

Exhibit 3-5. RCUT intersection with minor street approaches offset to produce a shorter pedestrian crossing.

An advantage of the RCUT intersection, compared to many other at-grade intersections and arterials, is the flexibility for traffic signal placement on the corridor. Because each direction of travel on the arterial can operate independently (i.e., similar to individual one-way streets), negligible vehicle delay to major-street vehicles results when installing additional traffic signals, as the signals can be timed to progress major-street vehicles. This feature allows mid-block pedestrian signals to be installed with minimal impact on vehicular travel time. Exhibit 3-6 shows three U-turn crossover configurations lending themselves to signalized mid-block pedestrian crossings, including one where there are two U-turn crossovers near each other, one where there are two U-turn crossovers some distance from each other, and one where there is one U-turn crossover.

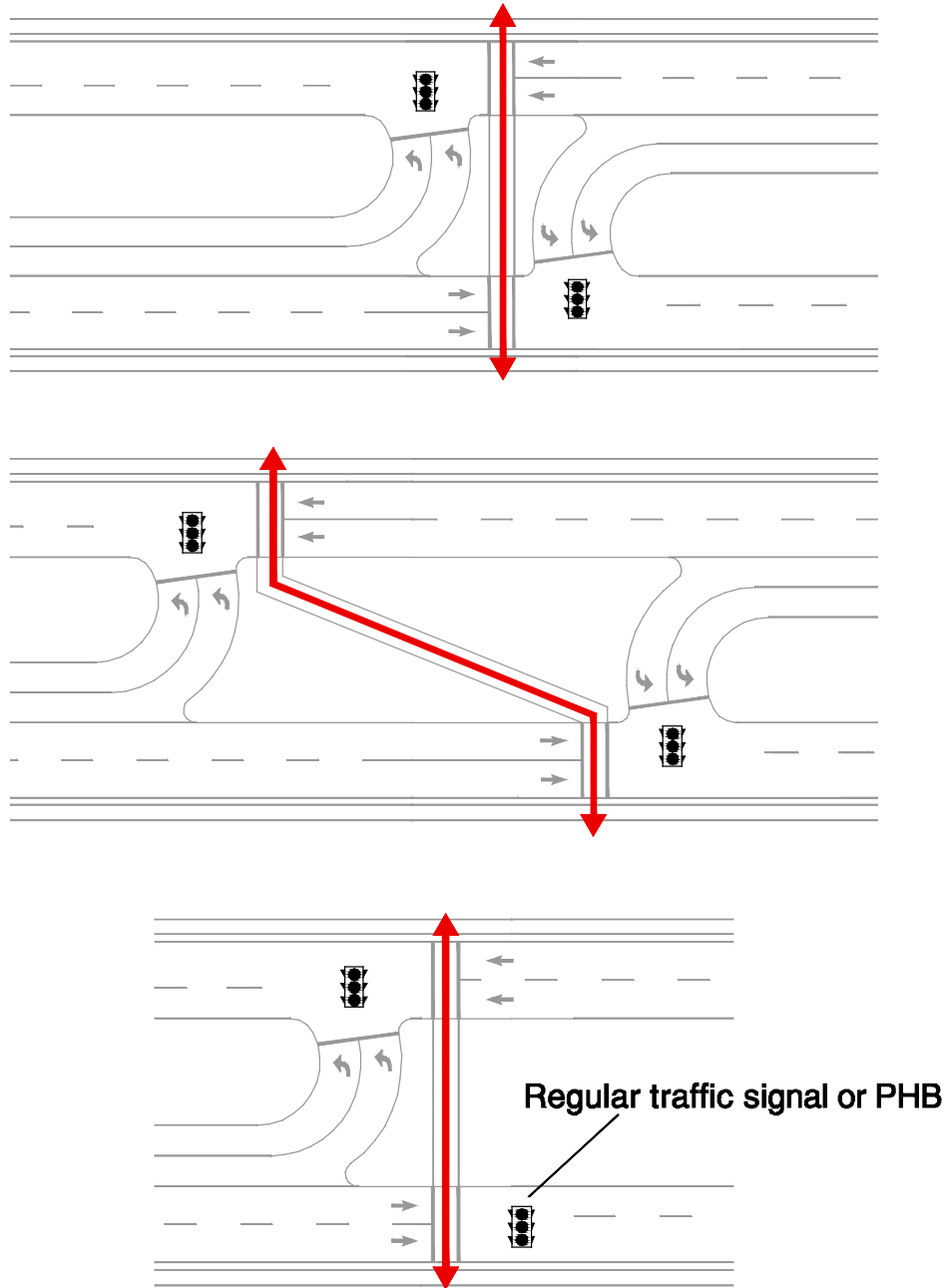

Exhibit 3-6. Three types of signalized mid-block crossing feasible on RCUT corridor.

In the latter case in Exhibit 3-6, the signal controlling the lower crossing can be a specialized signal, such as a pedestrian hybrid beacon (PHB; formerly known as a HAWK signal), to further minimize the impact to main street vehicle traffic. A PHB is only applicable in the latter case because in the first and second cases a conventional signal is needed to control vehicle traffic at the U-turn crossover.

The pedestrian crossing of a three-legged RCUT intersection requires at least one mid-block crosswalk, as shown in Exhibit 3-7. The crossing route is direct. The optional second mid-block crosswalk, just beyond the U-turn crossover, would reduce the amount of out-of-direction travel for some pedestrians. As it provides sizeable benefits to pedestrians at a minimal cost and impact to major street vehicles, the second crossing should be strongly considered.

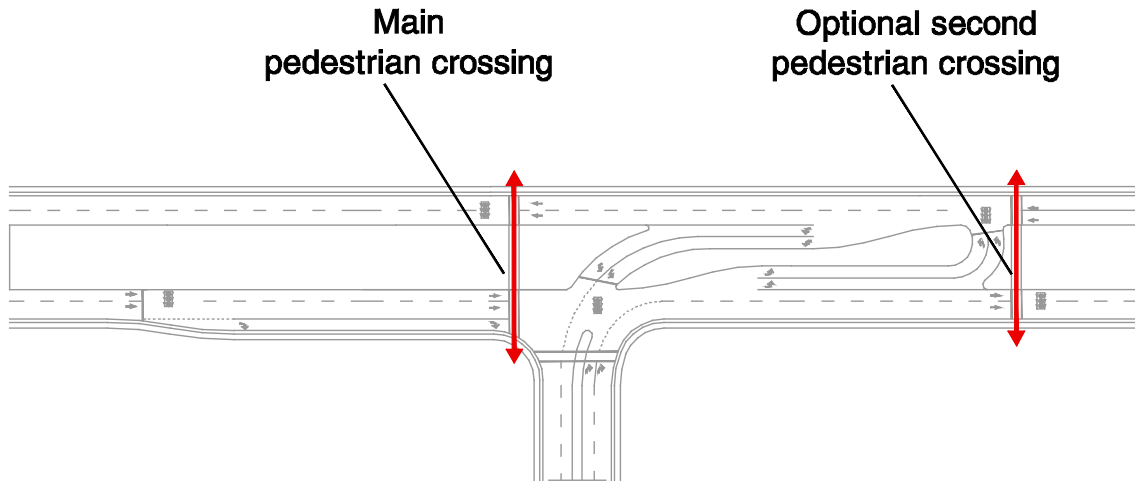

Exhibit 3-7. Pedestrian crossing of three-legged RCUT intersection.

Travel Time Experiment

Four pedestrian crossing treatments, shown in Exhibit 3-8, were evaluated by a recent research project sponsored by the NCDOT.⁽²⁴⁾ The researchers used a calibrated microsimulation model in a factorial experiment, systematically varying cycle length from 90 to 180 seconds, major street green split from 60- to 80-percent, and signal offsets. Pedestrians had origins and destinations in all four quadrants around the intersection, half of the pedestrians complied with all signals and half did not comply if a suitable gap presented itself, the major and minor streets both had four lanes, and the median was 40 feet wide. Exhibit 3-8 summarizes the pedestrian treatments and the modeled operational results of the four alternatives.

Restricted Crossing U-turn Informational Guide

Exhibit 3-8. Alternative crossing treatments and modeled operational performance for pedestrians.

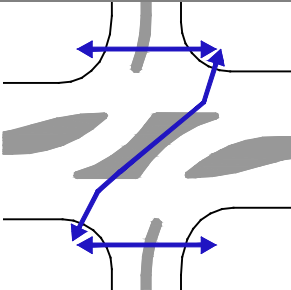
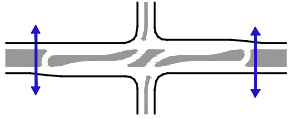
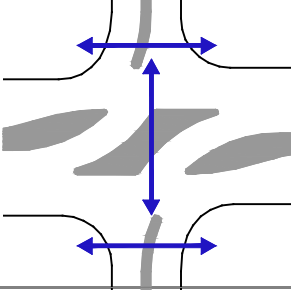
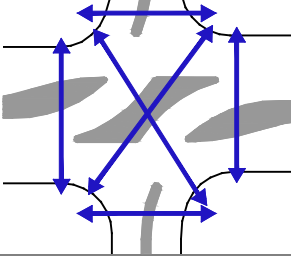
Crossing Type	Illustration	Mean Travel Time per Pedestrian (Sec)	Mean Total Delay per Pedestrian (Sec)
“Z”		465	132
Signalized Mid-block		479	119
Median Cross		487	160
Barnes Dance (exclusive pedestrian phase)		422	102

In many situations where an RCUT is being considered, the Barnes Dance exclusive pedestrian phase may not be practical due to operational trade-offs, but was included in the experiment to provide perspective to the other alternatives. As seen in Exhibit 3-8, the Barnes Dance produced the least pedestrian delay, while the median cross produced the greatest pedestrian delay of the modeled scenarios. Based on the extent of vehicle delay created by the Barnes Dance signal phasing, the researchers recommended a “Z” crossing or a combination of the “Z” crossing along

with signalized mid-block crossings.⁽²⁴⁾ Choosing the appropriate type of crossing, including signalization, depends on the context of the corridor and intersection under study.

Channeling Pedestrians to Cross Correctly

Wayfinding signing (and other wayfinding devices for the visually-impaired) can help direct pedestrians through the intersection to their desired destinations. Adequate wayfinding signing and other devices help direct pedestrians who are unfamiliar with a RCUT intersection's designated crossing patterns to cross streets at the appropriate locations.

Channelization, such as curbs, railings or landscaping, may be used to help pedestrians locate and use intended crossing locations. However, choices on the types of channelizing devices or features should take into account the proximity to traffic and appropriate roadside design principles. An example of a shared use path across a RCUT intersection is shown in in Exhibit 3-9. Exhibit 3-10 shows an example of a two-stage channelized pedestrian crossing at a conventional intersection in Tucson, AZ. Similar to a RCUT intersection, each crossing operates independently to enable bi-directional progression on the corridor.



Exhibit 3-9. Median shared-use path design for the US Route 15/501 RCUT intersection in North Carolina.⁽²⁵⁾



Exhibit 3-10. Two-stage channelized pedestrian crossing at conventional intersection.⁽²⁵⁾

ADA and PROWAG Accessibility Considerations

Accessibility was previously described in Chapter 2 in the broader contexts of considering a project's contextual environment and the ability for various users to approach a desired destination or potential opportunity for activity using highways and streets (including the sidewalks and/or bicycle lanes provided within those rights-of-way). In this section, accessibility is explicitly focused on the policies related to ADA and Public Rights-of-Way Accessibility Guidelines (PROWAG).⁽²²⁾ Special consideration should be given to pedestrians with disabilities including accommodating pedestrians with vision or mobility impairments. Being relatively new on a national level, specific guidance for "Accessible RCUTs" is not yet available. However, general accessibility principles can be borrowed from other forms of intersections and applied here. The United States Access Board provides many additional resources on accessibility and specific requirements for Accessible Public Rights of Way, to which the transportation professional should refer to and be familiar.⁽²²⁾

The basic principles for accessible design can be divided into the pedestrian walkway and the pedestrian crossing location. For the pedestrian walkways, the following considerations apply:

- Delineate the walkway through landscaping, curbing, or fencing to assist with wayfinding for blind pedestrians
- Provide sufficient space (length and width) and recommended slope rates for wheelchair users and other non-motorized users such as people pushing strollers, walking bicycles, and others
- Construct an appropriate landing with flat slope and sufficient size at crossing points

For pedestrian crossing locations, these additional considerations apply:

- Provide curb ramps and detectable warning surfaces at the edge of the sidewalk and transition to the street

- Separation of the pedestrian path from the back of curb and delineation of the pedestrian route using vegetative or other type of buffer
- Provide accessible pedestrian signals with locator tone at signalized crossings
- There is little experience with pedestrian crossings at unsignalized RCUT intersections. Treatments such as pedestrian hybrid beacons (PHB) and rectangular rapid flash beacons (RRFB) may be appropriate.
- Locate push-buttons to be accessible by wheelchairs and adjacent to the crossing at a minimum separation of 10 feet
- Use audible speech messages where spacing is less than 10 feet, or where additional narrative for the expected direction of traffic is needed (as may be the case for many major street crossings at RCUT intersections)
- Align the curb ramp landing to the intended crossing direction
- Crosswalk width through the intersection should be wide enough to permit pedestrians and wheelchairs to pass without delay from opposing directions, and the medians should provide sufficient storage for all non-motorized users to safely wait when two-stage crossing is required

All pedestrians—but especially those with vision, mobility, or cognitive impairments—may benefit from targeted outreach and additional informational material created with pedestrians in mind. These outreach materials include information on crosswalk placement and intended behavior, as well as answers to frequently asked questions. For blind pedestrians, materials need to be presented in an accessible format, with sufficient descriptions of all features of the RCUT intersection.

If all minor street lanes of a RCUT are channelized, accessibility considerations are similar to a conventional intersection approach without channelization. If a RCUT has a channelizing island separating some right-turn lanes from others, like the RCUT shown in Exhibit 1-5, sections of the PROWAG for channelized turn lanes at conventional signalized intersections will apply.⁽²²⁾

The pedestrian and vehicle paths in a RCUT intersection will likely be new to pedestrians, and extra guidance should be provided, especially for those users with vision or cognitive impairments who may not be able to use wayfinding signs. Some of the cues that pedestrians with vision impairments rely on to cross intersections (e.g., sound of traffic parallel to their crossing) will be different at the RCUT intersection. Locator tones on pedestrian signals and detectable warning surfaces are suggested. Audible pedestrian signals will be required at all new pedestrian traffic signals and are particularly beneficial at an unconventional intersection like a RCUT configuration.

Design features, such as smaller curb radii, minimize crossing distances at these locations and encourage pedestrians to cross in crosswalks. Minimizing conflicts between pedestrians and

vehicles by prohibiting right-turn-on-red (RTOR), especially for the major street right turns which typically have long green phases, may also provide safer pedestrian crossings.

Signal Phasing

For the “Z” crossing, pedestrians can cross the major street in one or two stages, depending on the signal timing offsets that define when a progression band arrives in each direction on the major street. A one-stage crossing occurs when the pedestrian can cross the main street without waiting in the median for a “walk” signal to cross the second direction. A two-stage crossing results when the pedestrian must wait in the median. Two signal phases are used to operate most RCUT intersections, which can result in a shorter cycle length. Therefore, the delay experienced by a pedestrian making a two-stage crossing should be relatively small compared to a two-stage crossing at a conventional intersection.⁽³⁾

Some pedestrian crossings at a RCUT intersection may have longer crossing distances and more conflict points compared to a conventional intersection despite the overall reduction in vehicle-pedestrian conflict points at the intersection. However, in contrast to most conventional signalized intersections with permissive (green ball) left and right turns, most pedestrian-vehicle conflict points at a RCUT intersection are protected. The only permissive conflict at a signalized RCUT intersection with a “Z” crossing involves the main street right-turning traffic and pedestrians crossing the minor street, although there will be a heavier volume of main street right-turning volume at a RCUT than at a comparable conventional intersection.

Signal design considerations are discussed in Chapter 8 of this guide.

BICYCLISTS

Bicycles on the major roadway travel through a RCUT the same way they travel through a conventional intersection. Minor street left-turning or through bicycles do not have a direct route at a RCUT intersection if they are travelling in vehicular lanes. At the same time, newer and reconstructed streets in many communities typically integrate Complete Streets policies that include bicycle facilities. RCUT intersections can be designed to reduce or eliminate out-of-direction travel by bicyclists. Consequently, both the challenges and benefits RCUT intersections offer bicyclists must be carefully evaluated to guide project planning and design decisions.

Major Street

Major street through and right-turning bicyclists at a RCUT intersection encounter relatively more green time percentages for their movements, resulting in lower delay and, potentially, fewer stops for red lights. RCUT intersections are generally constructed on higher-volume roadways, so physically separating bicycle lanes from general purpose lanes using buffered bike lanes, cycle tracks or similar treatments may be appropriate. Major street bicyclists turning left can ride in the left-turn lane or stop at the crosswalk and use the “Z” crossing like a pedestrian.

On the other hand, a higher volume of major street right-turning vehicles occur at RCUT intersections, compared to conventional intersections, resulting in more exposure between bicycle through and vehicle right-turn movements. An increasingly common practice at conventional or alternative intersections is to shift the right turn lane to the right of the bicycle

lane, illustrated in Exhibit 3-11. This exhibit identifies the conflict areas between through bicyclists and right-turning vehicles.

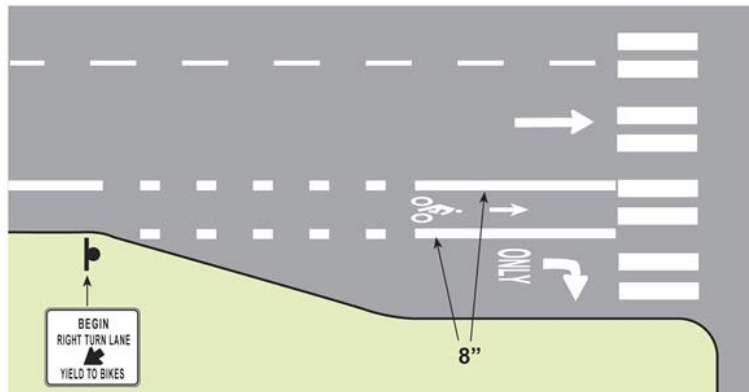

Exhibit 3-11. Right-turn lane with bicycle lane.

Minor Street

There are three primary ways to serve minor street through and left-turn bicyclists in a RCUT intersection: (1) similar to pedestrians, (2) similar to motor vehicle traffic, or (3) direct bicycle crossings. These options are illustrated in Exhibit 3-12. Bicyclists who desire to make a left turn or through movement from the minor street will be required to choose between using the “Z” crossing like a pedestrian, using the U-turn crossovers like a motorist, or passing through/across the channelizing island. The “Z” crossing is the best choice for bicyclists if the pathway through the intersection is designed for shared-use and wide enough to be comfortable for bicyclists. Otherwise, bicyclists may have to dismount and walk their bicycles across. If a direct bicycle crossing is not available, the choice of crossing with pedestrians or motorists will likely depend on the distance to the U-turn crossover and the type of bicyclist. A commuter bicyclist is more likely to prefer to travel in the street while novice (or recreational) bicyclists may prefer the path through the median. The choice will also depend on the quality of bicycling possible if riding with the motorists, determined by features such as the speed of the main street vehicle traffic, shoulder width or the presence of a bicycle lane, the volume of main street traffic, and the distance to the U-turn crossover.

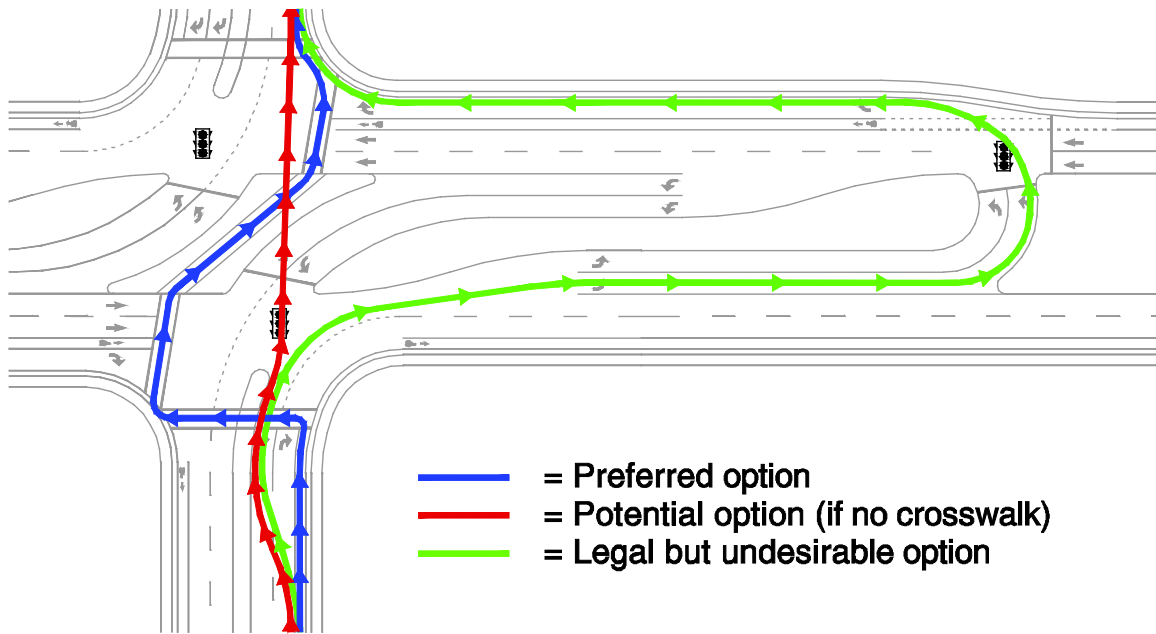

Exhibit 3-12. Minor street through options for bicycles.

The U-turn may be difficult for bicyclists. Vehicles executing U-turns will have difficulty staying in lanes, and large vehicles may produce greater off-tracking causing some vehicles to encroach into lanes occupied by bicyclists. This includes a lane beside a heavy vehicle at a multilane U-turn crossover, and a major street lane or shoulder opposite a U-turn crossover.

The third option, a direct bicycle crossing, would only be available without a pedestrian “Z” crossing. This option would be appropriate to design on a rural bicycle touring route without pedestrian facilities or at a RCUT intersection where a different pedestrian crossing treatment is used.

Appropriate signing is needed to direct bicycles to the pathway through the median and to assist a bicyclist in making decisions about riding or walking through the intersection. Exhibit 3-9 (above) shows a shared-use path through the median at a RCUT intersection, and Exhibit 3-10 (above) shows channelizing treatments that could be added to such a crossing (although more width would probably be necessary for bicycles). Design guidelines for shared-use paths for individual jurisdictions and at the national level should be referenced for specific recommendations on geometric elements of the path.⁽²⁶⁾

Exhibit 3-13 shows a treatment used in North Carolina to aid minor street left-turning and through bicyclists in negotiating a rural RCUT intersection with stop-control and no pedestrian facilities due to the lack of nearby pedestrian-generating land uses. The treatment consists of curb cuts and narrow paths through the median. Signs should be used to direct bicyclists to the crossing, since it otherwise may not be apparent it is intended for them.



Exhibit 3-13. Curb cut design used in North Carolina to assist bicyclists crossing at a rural RCUT with stop sign.⁽²⁷⁾

Travel Time Experiment

Alternative bicycle crossing treatments at signalized RCUT intersections were explored with a research project sponsored by the NCDOT.⁽²⁴⁾ Like the pedestrian crossing experiment presented earlier, the researchers used a calibrated microsimulation model in a factorial experiment, systematically varying cycle length from 90 to 180 seconds, major street green split from 60 to 80 percent, and signal offsets. Bicyclists had origins and destinations in all four quadrants around the intersection, all bicyclists complied with all signals, the major and minor streets both had four lanes, and the median was 40 feet wide. Exhibit 3-14 summarizes the bicycle treatments and the operational results of the four modeled alternatives.

Restricted Crossing U-turn Informational Guide

Exhibit 3-14. Alternative crossing treatments and modeled operational performance for bicyclists.

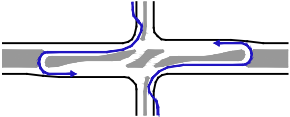
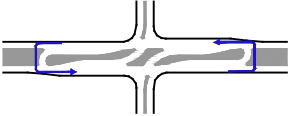
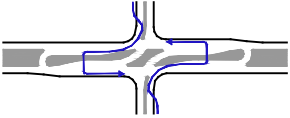
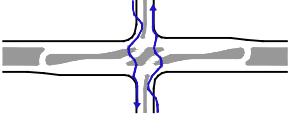
Crossing Type	Illustration	Mean Travel Time per Bicyclist (Sec)	Total Delay per Bicyclist (Sec)
Vehicle U-turn Crossover		564	420
Signalized Shared-use Mid-block Crossing		428	282
Bicycle U-turn Crossover		542	403
Direct Cross		328	210

The minimum free-flowing bicycling time through the network was about 120 seconds. The direct cross treatment had the lowest modeled delay to bicyclists, while the U-turn crossovers generally had the highest delay of the modeled scenarios. Although the direct cross treatment looks promising, there are no known implementations, and there are many details related to geometric design, signing, and signaling that have not been studied and developed.

TRANSIT VEHICLE CONSIDERATION

A RCUT intersection can provide significant benefits to most transit users due to the ability to progress traffic in both directions along the major street, which results in higher average bus speeds. However, bus routes following the minor street at a RCUT intersection, or making a minor street left turn, will likely experience extra time compared to a conventional intersection as the buses use the U-turn crossovers. U-turn crossovers designed to accommodate large combination trucks without curb encroachments, as Chapter 8 presents, should be able to accommodate standard transit and school buses.

Bus Stop Locations

RCUT intersections may serve bus stops on either the intersection's near- or far-sides, just like at conventional intersections. Mid-block stops near the U-turn crossover are also an option, particularly if a signalized crossing on the major street is also provided at this location. Exhibit 3-15 shows these three options. Unique aspects of RCUT intersections that should be considered when locating bus stops are discussed below.

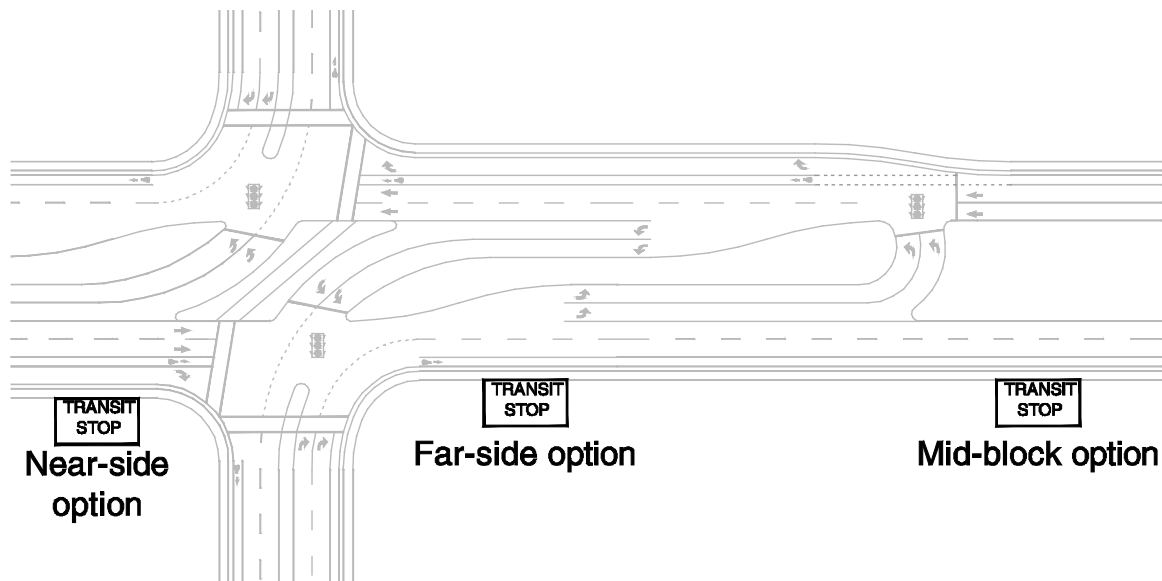

Exhibit 3-15. Potential bus stop locations at a RCUT intersection.

Far-side bus stops typically result in lower levels of vehicular delay than near-side bus stops. However, far-side stops at a RCUT intersection with a "Z" crossing place the bus stops away from the pedestrian crosswalk across the minor street. This placement may encourage prohibited pedestrian crossings and will increase the time required for alighting bus passengers to reach destinations on the other side of the street. A far-side stop would be located, in order of preference, (1) in an exclusive bus lane, (2) in a pullout accessed via the near-side right-turn lane (exempting buses from the right-turn requirement), and (3) in the curbside travel lane (potentially blocking cross-street right turns). If a pullout is used, consideration should be given to how the bus will re-enter the travel lanes.

A nearside stop is also an option at a RCUT intersection. In this case, a bus stopped at a nearside stop in the right-turn lane will block right-turn movements, which could cause motorists to make undesirable turns in front of the bus from an inside lane. One alternative would be to channelize the right turn, develop a short bus lane out of the right-turn lane up to the intersection, and to place the bus stop on the channelizing island. This alternative keeps buses from blocking the right-turn lane. The two-phase signal operation minimizes delay to buses that fall out of progression while serving passengers at the bus stop. Buses could be provided with a queue-jump phase when exiting the stop or could continue on an extension of the bus lane.

When bus routes run along the minor street and must cross the intersection, offering bus stops on both the near- and far-side of the intersection is preferred. Far-side stops can be located on the major street at a shared major street/minor street bus stop if major street bus service is present. Exhibit 3-16 shows major street nearside bus stops can be located in conjunction with minor street stops and the “Z” crossing.

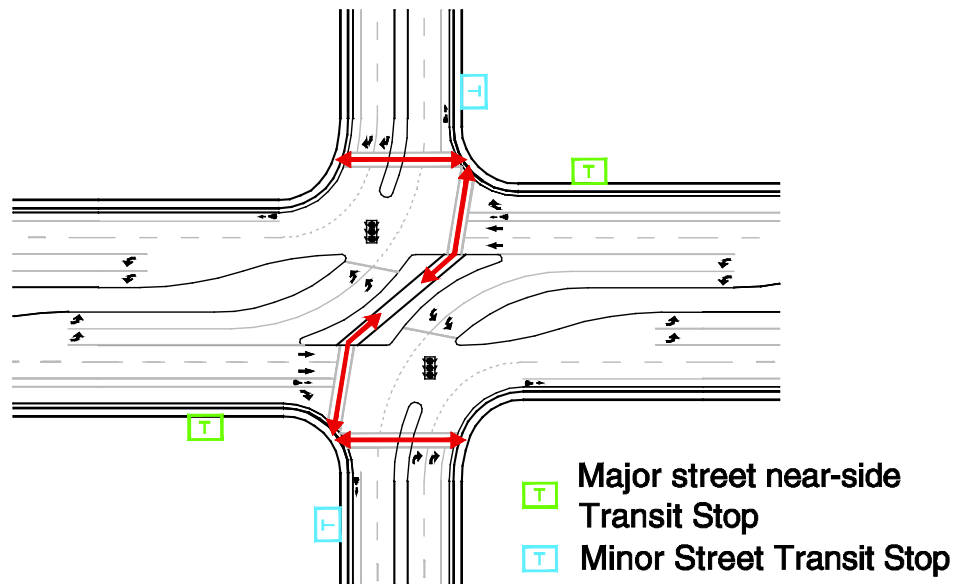

Exhibit 3-16. Bus stop locations on the minor and major streets at a RCUT intersection.

When a bus route turns left from the major street, the bus stop should be located on the minor road so buses do not have to weave from the outside lane into the inside lane to use the U-turn. Bus stops should not be located in loons to keep them free for turning vehicles. An additional option for bus stop placement at a RCUT intersection is between two U-turn crossovers, as shown in Exhibit 3-17.

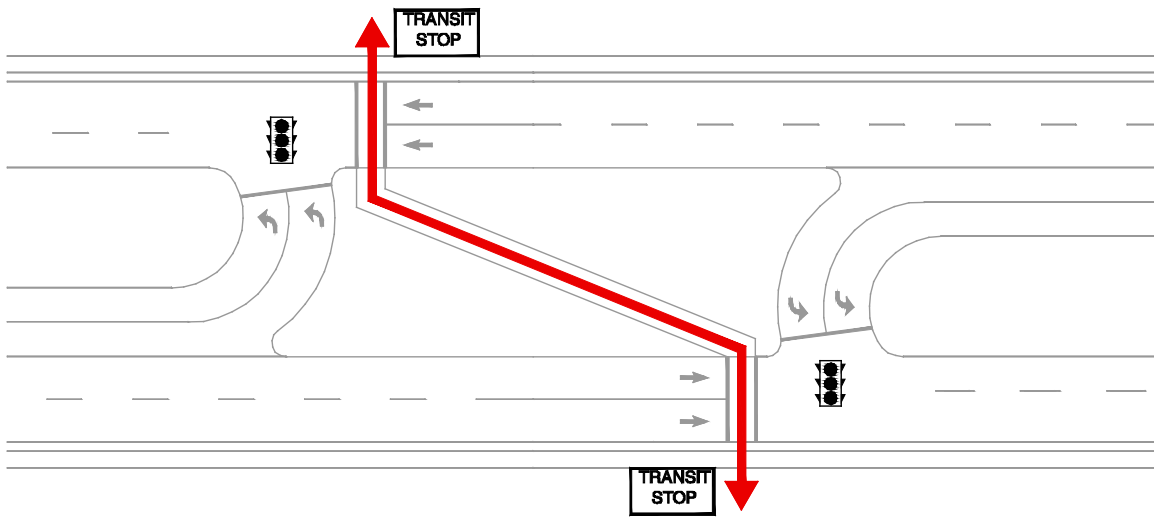

Exhibit 3-17. RCUT intersection major street bus stop placement options between U-turn crossovers.

The advantage of this option is that there is no major street right-turning traffic and bus conflicts and pedestrians have a signal-controlled crossing of the arterial nearby. However, the disadvantage of this stop placement is that it is not near the minor street. Bus stops could be “nearside” in front of the stop bar or “far-side” beyond the stop bar, as Exhibit 3-16 shows; nearside placement could mean loss of efficiency in the lane where the bus stops are while far-side placement could mean longer lost times for main street traffic.

RCUT with Bus Rapid Transit or Light Rail

A RCUT corridor is efficient for major street movements and could be beneficial to rail transit operations. As with conventional intersections, bus rapid transit (BRT) or light rail transit (LRT) could be incorporated at a RCUT intersection. Key elements to be evaluated with the RCUT operations include route alignment, stop or station placement, and connectivity with pedestrian crossing locations.

HEAVY VEHICLE CONSIDERATIONS

The typical RCUT crossover can serve heavy vehicle U-turn movements given the wide median provided in a typical RCUT corridor. The crossover design detail is further described in Chapter 7. A single-lane crossover is designed to provide adequate turning radii and tracking for both the front and rear ends of trucks. If the median width is less than adequate for larger vehicle U-turns, additional pavement can be added at the far side of the U-turn crossover in the form of loons (see Chapter 7).

This page intentionally left blank.

CHAPTER 4 — SAFETY

This chapter provides an overview of the safety considerations and elements affecting decisions about RCUT intersections. The chapter begins with a discussion of safety principles and the theoretical safety attributes of RCUT intersections. The next section describes the empirical evidence available regarding crash frequency and severity at RCUT intersections. Finally, the chapter contains sections discussing additional safety considerations, emergency vehicle considerations, and techniques for evaluating safety at RCUT intersections. RCUT intersections with stop signs or merges are often installed as safety countermeasures at conventional intersections to reduce crash frequency and severity. Many other alternative intersection forms, including RCUT intersections with signals, may offer safety benefits to all road users but are generally installed to improve traffic operations.

SAFETY PRINCIPLES

Conducting an appropriate level of safety assessment corresponding to the stage of project development process (planning, alternatives identification and evaluation, preliminary design, final design, and construction) supports decisions about RCUT intersections. The analysis should be consistent with the available data, and the data should be consistent with the applied tools. Multimodal safety principles, including vehicle-pedestrian and vehicle-bicycle conflict points, accessibility, and crossing options, are discussed in Chapter 3.

Reduced Vehicle-Vehicle Conflict Points

Crash data are often used to develop safety performance functions or crash modification factors (CMFs) to ultimately help professionals make decisions about street network features. Crash data are often limited or unavailable for some types of facilities. The documented safety performance of RCUT intersections is limited because they are relatively new and still not common. Safety surrogates may be useful to support intersection form selection.

While no mathematical relationship between conflict points and crashes has been determined, conflict points are often used as a surrogate measure, particularly to compare different intersection forms. Exhibit 4-1 shows the number of vehicle-to-vehicle conflict points present at three- and four-leg RCUT and conventional intersections. The RCUT intersection offers substantial decreases in conflict points for three-leg and four-leg intersections compared to conventional forms.

Exhibit 4-2 shows the conflict diagram for vehicles at a conventional four-leg intersection, while Exhibit 4-3 shows the conflict diagram for vehicles at a four-leg RCUT intersection. These diagrams are based on traffic streams, so the number of conflict points does not change as the numbers of lanes change. At a four-leg intersection, a RCUT has 14 conflict points compared to 32 at a conventional intersection. In addition to reducing total conflict points, RCUT intersections reduce crossing conflict points. Crossing maneuvers can result in angle crashes a crash type that is generally more severe than other types.

Exhibit 4-1. Conflict point comparison.

Number of Intersection Legs	Conflict Points	
	Conventional	RCUT
3	9	7
4	32	14

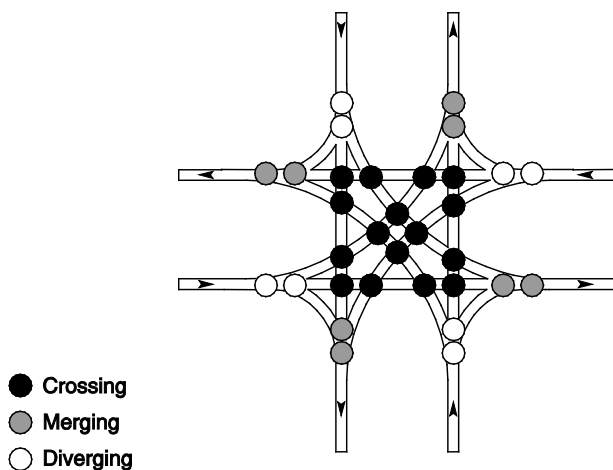

Exhibit 4-2. Vehicular conflict points at a four-approach conventional intersection.

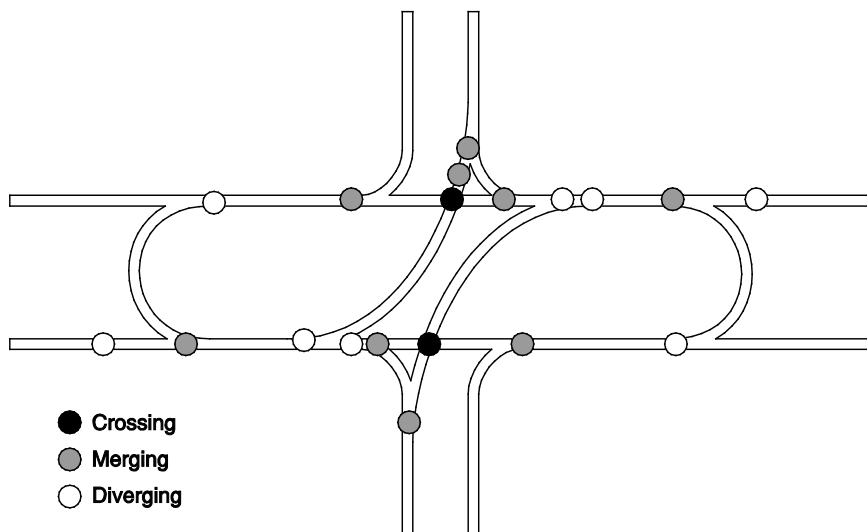

Exhibit 4-3. Vehicular conflict points at a four-approach RCUT intersection.

Speed Profile from Signal Progression

Another safety surrogate, especially for crash severity, is the speed profile along a facility. In this regard, a corridor of signalized RCUT intersections have an advantage over other alternative intersections and conventional intersections in that the independent progression for each direction of travel maximize the percent of green time for the major street and make signal coordination comparable to a one-way street couplet. This is described further in Chapter 5. With a RCUT intersection's progression capability, an agency has greater control over the progression speed; this could be used, for example, to slow drivers through an area with many signals or to more easily accommodate pedestrian crossings without disrupting coordination.

Human Factors, Principles, and Considerations

Human factors and driver expectancy suggest motorists typically accustomed to using conventional intersections position their vehicles to the left side of a directional street when approaching an intersection where they intend to make a left turn. Similarly, motorists position their vehicle to the right side of the directional street when approaching an intersection where they intend to make a right turn. The RCUT intersection is consistent with these expectations for major street drivers.

Drivers who are unfamiliar with the intersection form and intend to make a left turn or through movement at the minor street may not expect to first make a right turn at the major cross street. After making a U-turn and heading back to the main intersection, minor street drivers will have to move into position for a through or right-turn movement. Compared to intersection designs that prohibit movements using signs and markings, such as MUT intersections, RCUT intersections should be easier for drivers to negotiate because channelization typically prevents drivers from making prohibited movements.

Compared to a conventional intersection form with permissive or protected-permissive left-turn or right-turn signal phasing, signalized RCUT intersections reduce the decision-making burden for motorists. Whether the conflicting traffic consists of vehicles or pedestrians or both, turning drivers using permissive or protected-permissive signals at a conventional intersection have to look for a gap in vehicle traffic and crossing pedestrian traffic before beginning their turn movement. In contrast, motorists using the two-phase signals at a RCUT intersection have a reduced set of decisions to make at each junction. At a typical signalized RCUT intersection, there are no uncontrolled vehicle-vehicle conflict points. There are two uncontrolled vehicle-pedestrian conflict points, one at each major street right turn conflicting with pedestrians crossing the minor street. RCUT intersections also offer simplified decision-making in comparison to a conventional two-way stop-controlled intersection with a two-way median opening on a divided street. Traffic using the two-way median opening faces potential conflicts from other vehicles in the median, and a RCUT intersection removes these conflicts by eliminating movements.

RCUT intersections often use unique signing and marking designs to help motorists negotiate unfamiliar movements and avoid incorrect maneuvers. Wrong-way signs and arrow pavement markings will decrease the likelihood of a motorist travelling the wrong way through a median opening. A set of signs and markings that repeats the needed message, perhaps using different

devices, helps minor street left turn and through vehicles navigate to the U-turn crossover and return to the main intersection. Chapter 8 shows devices agencies have deployed at RCUT intersections.

OBSERVED SAFETY PERFORMANCE

There is little published crash data and documented safety performance for RCUT intersections. There have been two noteworthy studies of RCUT intersections with stop signs and one noteworthy study of RCUT intersections with merges. There has not yet been a noteworthy study of crash experience at RCUT intersections with signals, and no crash data involving pedestrians or bicycles at RCUT intersections have been analyzed. This section presents and discusses available empirical safety results for RCUT intersections in the United States.

RCUT Intersections with Stop Signs

North Carolina Study

Researchers completed a safety analysis of RCUT intersections with stop signs in North Carolina in 2010.⁽¹¹⁾ The analysis examined crash data before RCUT intersection installation—when the intersection was operated as a conventional stop-controlled intersection with a two-way median opening—and after RCUT intersection installation. The sample included 13 RCUT intersections across the state where a two-lane rural minor road intersects a four-lane high-speed (greater than or equal to a posted speed of 55 miles per hour [mph]) major road. Exhibit 4-4 shows a typical site. Before periods were typically about five years, and after periods ranged from 8 to 115 months.



Exhibit 4-4. Typical site in NCDOT study of RCUT intersections with stop signs.⁽²⁾

Exhibit 4-5 shows the results from four different types of analysis. The analysis results account for the different lengths of time between the before and after periods. The naïve analysis and comparison group analysis do not account for regression to the mean; therefore, we do not know the degree to which the changes in crashes shown are attributable to the RCUT intersection form or the natural regression of crashes to a long-term average. The two analyses included the empirical Bayes methodology do account for regression to the mean, therefore providing a higher degree of confidence the changes in crashes shown are due to the RCUT intersection. However, as the sites included in the empirical Bayes analysis were those selected because of their higher crash frequency, the results shown may overestimate the expected number of crashes reduced. Each analysis shows a drop in total crashes with RCUT intersection installation ranging from 27- to 74-percent. Fatal and injury, angle, and left-turn crashes decreased by more than half following the RCUT intersection installation, while sideswipe, rear-end, and other types of crashes tended to decrease by a lesser degree or increase.

Exhibit 4-5. Results of analyses of RCUT intersections with stop signs in North Carolina.⁽¹¹⁾

Type of crash	Percent change in crashes from conventional to RCUT intersection			
	Naïve analysis	Comparison group analysis	Naïve empirical Bayes analysis	Empirical Bayes analysis with comparison groups
Total	-34	-46	-27	-74
Fatal and injury	-58	-63	-51	-85
Angle	-86	-74	-86	-78
Left-turn	-75	-59	-76	-66
Sideswipe	15	-13	-12	-36
Rear-end	7	-1	12	-16
Other	15	-15	8	-27

Missouri Study

Edara, et al. evaluated five RCUT intersection installations in Missouri.⁽¹⁴⁾ The locations were on rural, four-lane highways; one major road had a speed limit of 70 mph while the other sites had speed limits of 65 mph. One site had three legs, and the others had four legs. Major road average annual daily traffic (AADT) ranged from 10,000 to 26,000 vpd while minor road AADT ranged from 400 to 1,300 vpd. The RCUT intersections and the conventional intersections they replaced had stop sign control on the minor streets. Three years of before data and one to three years of after data were available at each. The authors employed an empirical Bayes analysis method to account for potential regression to the mean bias. The empirical Bayes procedure used the crash prediction model from the Highway Safety Manual (HSM) for rural four-lane highway intersections with calibration factors from Missouri. The results indicated the RCUT intersection installation reduced total reported crashes by 35-percent on average, and reduced injury and crashes by 54-percent on average. There were no fatal crashes at the five RCUT intersection study sites during the study period after installation. As in North Carolina and Maryland, the researchers observed a large reduction in angle crashes after the RCUT intersection installation.

RCUT intersections with Merges

Researchers completed a safety analysis of RCUT intersections with merges in Maryland in 2012.⁽¹²⁾ The analysis examined crash data before RCUT intersection installation (when the intersection was operated as a conventional stop-controlled intersection with a two-way median opening) and after RCUT intersection installation. The sample included nine RCUT intersections on US-15 in central Maryland and US-301 on the Eastern Shore of Maryland where a two-lane rural minor road met a four-lane, 55 mph major road. Exhibit 4-6 shows a typical site. Typically, the distance from the main junction to a U-turn crossover was approximately 2,000 feet. Before and after periods were three years. A set of comparison sites was gathered to adjust for history and maturation biases, and a “wider range of similar sites” was gathered to adjust for potential regression to the mean. The researchers also collected traffic conflicts and other observational field data.



Exhibit 4-6. Typical site from FHWA study of Maryland RCUT intersections with merges.⁽³⁾

The researchers conducted three types of analysis on the crash data: a naïve analysis, which accounted for no potential biases; a comparison group analysis, which accounted for history and maturation biases using the set of comparison sites but did not account for regression to the mean; and an empirical Bayes analysis, which accounted for regression to the mean using the rural intersection safety performance function from the HSM calibrated for Maryland.⁽⁸⁾ The analysis using the empirical Bayes and calibrated safety performance function is considered to produce the most reliable results. This analysis showed a 44-percent decrease in total crashes. The field observations showed there were fewer conflicts at RCUT intersections than comparable conventional intersections during several hours of data collection.

RCUT Intersections with Signals

There are no known empirical, rigorous safety analyses of signalized RCUT intersections. FHWA has commissioned a study to determine a CMF for replacing a conventional signalized intersection with a signalized RCUT intersection, and results are expected in 2015.

Summary

Exhibit 4-7 summarizes the results from the three major empirical studies of unsignalized RCUT intersections published thus far. The data suggests installing unsignalized RCUT intersections in circumstances similar to those studied in North Carolina, Maryland, and Missouri will likely result in a one-third reduction in crashes and a one-half reduction in injury crashes.

Exhibit 4-7. Summary of empirical safety studies of unsignalized RCUT intersections.

State	North Carolina ⁽¹¹⁾	Maryland ⁽¹²⁾	Missouri ⁽¹⁴⁾
Number of RCUT intersection sites	13	9	5
Type of traffic control	Stop	Merge	Stop
% decrease in total crashes	27	44	35
% decrease in injury crashes	51	42	54

SAFETY CONSIDERATIONS

The general pattern after replacement of a stop-controlled conventional intersection with a stop-controlled or merge-controlled RCUT intersection is of many fewer angle and turning crashes but the chance of slightly higher sideswipe and rear end crashes. There are several safety considerations to potentially mitigate negative effects.

Minor Street Right Turns

One safety consideration at a signalized RCUT intersection with multiple lanes on the minor street approaches is the potential for sideswipe crashes. Drivers turning right from the minor street may not be intuitively aware which lanes they should use to position themselves for the next movement. Minor street left-turning vehicles should generally stay to the left on the minor street approach, minor street through vehicles should stay in the middle, and minor street right-turning vehicles should stay to the right. However, minor street drivers at a RCUT intersection may have a tendency to seek a better position in the queue, irrespective of the next maneuver downstream. Chapter 8 shows traffic control devices agencies have chosen for RCUT intersections to balance lane choice guidance and lane choice flexibility. Applying traffic control devices resulting in unneeded exclusive lanes may lead to loss of efficiency as queue lengths become uneven.

Deceleration Lane Spillback

Spillback out of the deceleration lane leading to a crossover is a safety concern at RCUT intersections, particularly those with signals. Signalized RCUT intersections are typically efficient enough due to progressed two-phase signals with short cycles that spillback is not common. However, the crossovers are closely spaced; increasing the possibility. The geometric design of a RCUT intersection should go hand-in-hand with the operational analysis, and spillback potential should be checked during design. Potential treatments include signal timing adjustments, changing single-lane crossovers into dual-lane crossovers, and increasing the distance between the main junction and the U-turn crossover in question. Chapter 5 discusses moving crossovers at a RCUT intersection without impacting signal progression along the major street.

Weaving

RCUT intersections with stop signs or signals controlling the minor street and crossovers do not create weaving movements on the major street. Instead, drivers must wait for an acceptable gap

or a green signal. In contrast, RCUT intersections with acceleration lanes and merges at the minor street and the U-turn crossovers do create weaving movements. A minor street left-turning or through driver emerging from the minor street will, in effect, have to make a two-sided weave right to left. A minor street through driver emerging from the U-turn crossover will have to make a two-sided weave left to right. To minimize the risks in those two-sided weaving maneuvers, the crossover can be located far enough away from the minor street to create acceptable weaving operations; this distance is up to one-half (0.5) mile at some RCUT intersections with merges. The AASHTO Green Book contains recommendations on acceleration and deceleration lane lengths appropriate to RCUT intersections with merges.⁽⁵⁾ Heavy vehicles and uphill grades influence crossover distances and lane lengths, and required associated appropriate traffic control devices.

Right-Turn / U-turn Conflicts

Where crossovers are aligned with streets or driveways that permit only right turns, U-turns from the crossover and right turns from the street/driveway are potentially in conflict depending on driver lane choices. Where lower volumes exist on the crossover and/or the opposing street, and where the main street is sufficient to accommodate simultaneously turning vehicles (i.e. three or four lanes in each direction), U-turns and right-turn movements can be served under the same signal phase. However, at signalized intersection locations where the volumes of right-turn and U-turn movements create conflicting movements, separate signal phases can be provided for U-turn and right-turn phases. For a given site, a study would be required to determine if the additional signal phase impacts the main intersection phasing and main street progression, and if an additional U-turn and/or an additional right-turn lane is needed to provide sufficient capacity and operations. U-turn movements also potentially conflict with buses on the major street, such as bus stopped opposite or several vehicle lengths downstream from a crossover. A bus at such a stop would wait until a gap in major street traffic and U-turning traffic was present before departing. Exhibit 4-8 shows an example of a U-turn/right-turn conflict.

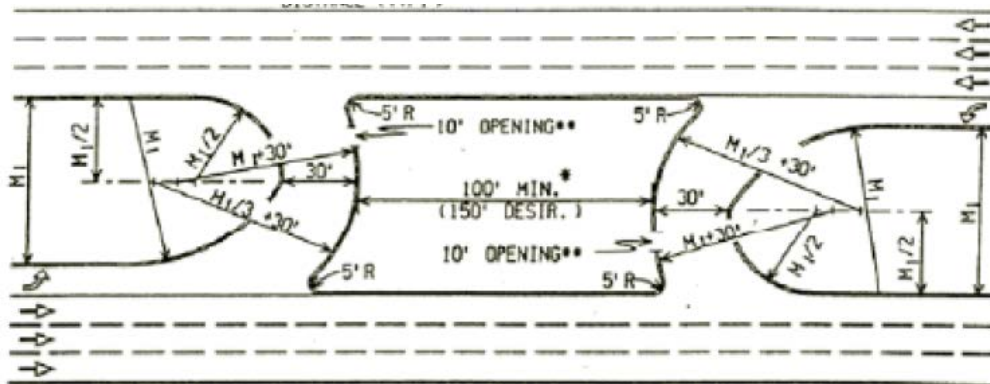

Exhibit 4-8. Example of U-turn/right-turn conflict.⁽³⁾

Potential for Wrong Way and Other Illegal Movements

U-turn crossovers are directional, not two-way as in typical divided highway corridors. This typically has no negative effects if crossovers are designed with channelization to prevent

wrong-way movements. Exhibit 4-9 provides the details of a Michigan Department of Transportation (MDOT) typical U-turn crossover.⁽²⁸⁾ MDOT uses these crossovers for MUT intersections, but a RCUT crossover could be designed in the same manner.



Source: Michigan Department of Transportation *Geometric Design Guide 670*

Exhibit 4-9. U-turn crossover detail.⁽²⁸⁾

Another place at a RCUT with the potential for prohibited movements potentially leading to crashes is at the main intersection. Drivers may be tempted to make direct left turns from the minor street. Providing curbed islands, delineation, and clear traffic control devices at the main intersection will help overcome this temptation. Some presence by law enforcement, especially in the first few weeks that a RCUT intersection is open, may also be beneficial.

Intersection Sight Distance

Minimum distance between consecutive U-turn crossovers allows drivers at one stop bar to see past a queue built up in the storage bay of the other crossover. Exhibit 4-9, from MDOT, calls for a minimum separation of 100 feet and a desirable separation of 150 feet between U-turn crossovers. If consecutive U-turn crossovers must be closer together, the location could be signalized or left turns on red (LTOR) could be prohibited. Intersection sight distances at RCUT crossovers can be attained by carefully designing slopes and cutting back plantings in the median beyond the lines of sight.

Truck Navigation of Crossovers

For U-turn crossovers with multiple lanes, designing adequate crossovers for large trucks requires focused detail on truck turning paths. First, large trucks should be signed to use the rightmost, or outermost, U-turn lanes. Secondly, the crossover must accommodate vehicle tracking through the crossover so the path of a design vehicle (such as a WB-67) does not overlap with the path of a passenger car or single-unit truck in the leftmost of the dual lanes. Exhibit 4-10 illustrates the potential for vehicle overtracking; design details for dual-lane crossovers are provided in Chapter 7.

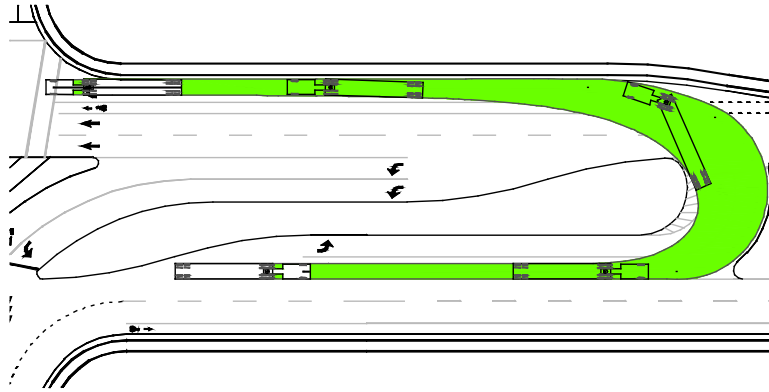

Exhibit 4-10. Dual-lane crossover design overtracking potential.

INCIDENT RESPONSE CONSIDERATIONS

Most incident responses and emergency vehicle operations at a RCUT intersection will be unchanged from a comparable conventional arterial with a median because major street vehicles proceed in the same way. Considerations for other movements are noted below:

- One-lane crossovers can be designed wide enough for emergency vehicles to pass a queue if needed. The typical one-lane U-turn crossover width in Michigan at MUT intersections is 30 feet, which is also sufficient for this purpose at a RCUT intersection.
- Channelizing islands in the median opening of the main intersection can be mountable to allow emergency vehicles to make left-turn or minor street through movements. Many of Maryland's RCUT intersections with merges have this treatment.
- RCUT intersections may be undesirable at intersections where an emergency vehicle station is located on the minor street. Emergency vehicles making left turns or through movements from minor streets will have to negotiate the U-turn crossover or cross mountable channelizing islands, which will add to the response time.

SAFETY EVALUATION CONSIDERATIONS

Crash Modification Factors (CMF) in FHWA's CMF Clearinghouse are available for converting unsignalized conventional intersections to unsignalized RCUT intersections.⁽²⁹⁾ A 2012 study by Inman and Haas found a CMF value of 0.56 with a 3-star rating for all crash types and all crash severities in a rural area.⁽¹²⁾ A 2010 study by Hummer et al. found a CMF value of 0.54 with a 3-star rating for all crash types and all crash severities in a rural area.⁽¹¹⁾

The studies noted above also developed CMFs specific to certain crash types, crash severities, area types, and other parameters. These CMFs can be obtained directly from the CMF Clearinghouse.

RCUT intersections are sometimes installed in combination with access management techniques along a highway corridor. There are numerous locations in urbanized areas where businesses line the street with multiple driveways for ingress and egress. One practice in the past has been to

provide two-way center left-turn lanes (TWLTLs) to accommodate left turns into and out of the businesses. However, the use of TWLTLs may not be equally appropriate along all types of roadways. Some jurisdictions are removing the TWLTLs and installing raised medians, which, like an RCUT, only permit right turns by vehicles entering or exiting the driveways and have been shown to improve corridor safety.⁽³⁰⁾

There are several factors to consider in conducting before-and-after safety evaluations of RCUT projects:

- The boundaries of the analysis area need to be large enough to include all crossovers. It would be unfair to compare a conventional intersection to just the main junction of a RCUT intersection.
- Minor street left-turn and through vehicles at a RCUT intersection drive longer distances to negotiate the intersection than comparable conventional intersections. Thus, analyses using rates, such as crashes per vehicle-mile, should adjust for these “extra” distances driven.
- It is possible some drivers, especially on minor street approaches to a RCUT intersection, may alter their routes to avoid the intersection. Thus, crash migration is a possible threat to the validity of a before/after analysis. Analyses should consider traffic demands during the before and after periods. If crash migration is suspected, the scope of the analysis should be widened to include the new routes drivers are using.
- RCUT intersections are often installed as safety countermeasures at high-crash conventional intersections. This reinforces the need to account for regression to the mean in an analysis.
- RCUT intersections are often installed in conjunction with developments that generate traffic. This reinforces the need to account for volume in an analysis.

General guidance on before/after safety studies and development of CMFs can be found in FHWA’s A Guide to Developing Quality Crash Modification Factors.⁽³¹⁾

CHAPTER 5 — OPERATIONAL CHARACTERISTICS

This chapter provides information on the unique operational characteristics of RCUT intersections and how they affect elements such as traffic signal phasing and coordination. The guidance presented here builds on existing RCUT intersection studies, which include operational performance studies, comparative performance studies, and simulation analysis. It is intended to help prepare transportation professionals for conducting operational analysis as described in Chapter 6.

OPERATIONAL PRINCIPLES

This guide describes three main types of RCUT intersections: signal-controlled, stop-controlled, and with merges. This chapter concentrates on RCUT intersections controlled by signals. At a conventional intersection being considered for conversion to a RCUT with stop signs or merges, agencies should expect the minor street movements being rerouted to the U-turn crossovers to experience more travel time. At Maryland RCUT intersections with merges where U-turn crossovers are typically around 2,000 feet from the main intersection, this extra time is usually around one minute per vehicle.⁽¹²⁾ However, the alternative to RCUT intersection installation is often signal installation, where additional delay is incurred by major street through vehicles due to the traffic signal.

Exhibits 5-1 shows the concurrent movements at a conventional intersection and at a signalized RCUT intersection. Exhibit 5-2 shows the typical signal locations for a RCUT intersection. At a RCUT with a “Z” crossing, pedestrians would cross the minor roadway during the signal phase shown in Exhibit 5-1, and they would cross the major roadway during the signal phase not shown in Exhibit 5-1.

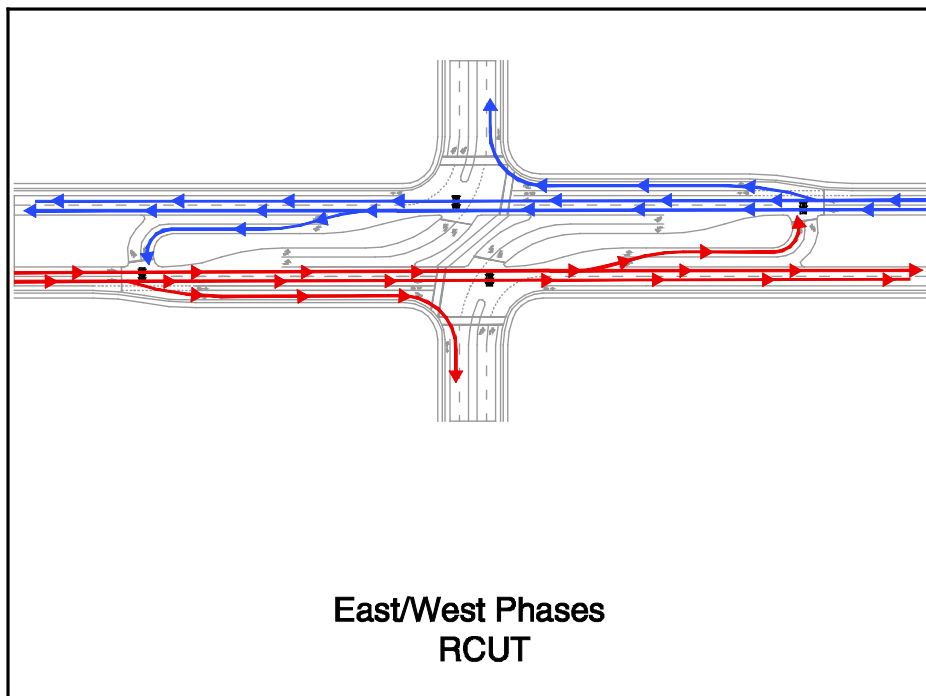
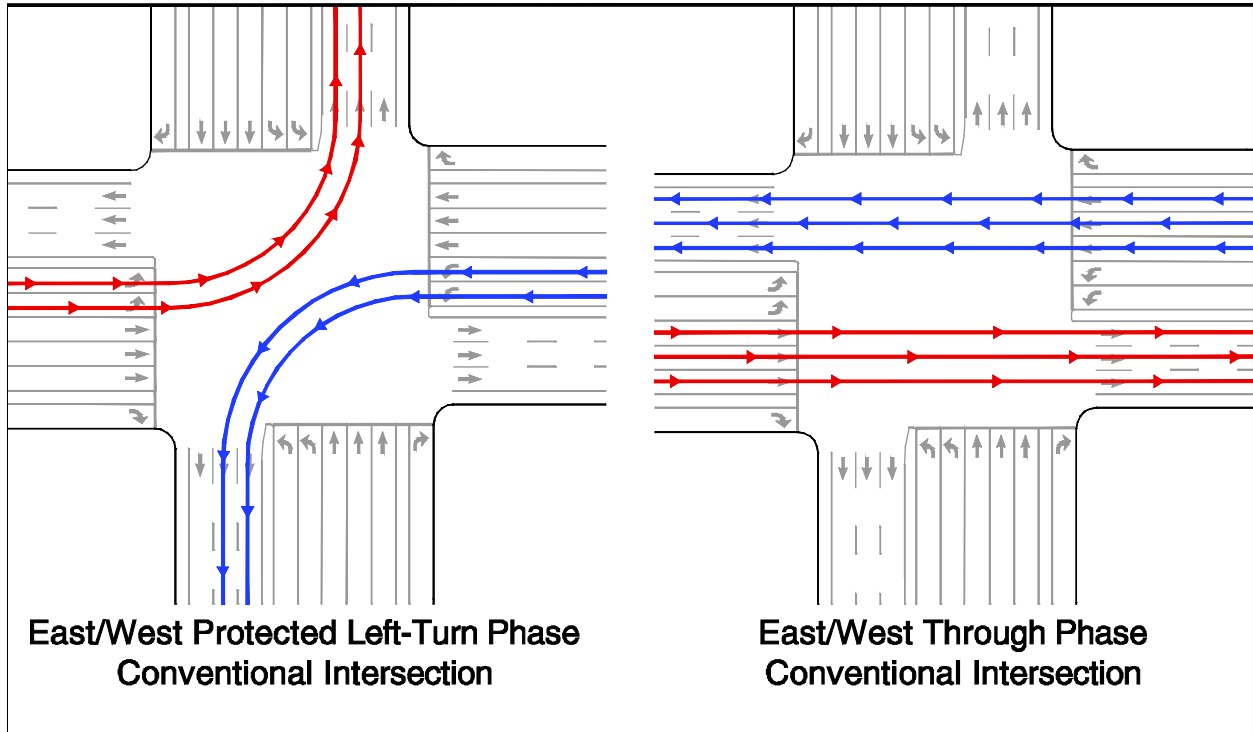

Exhibit 5-1. Concurrent movements at conventional intersection and signaled RCUT intersection.

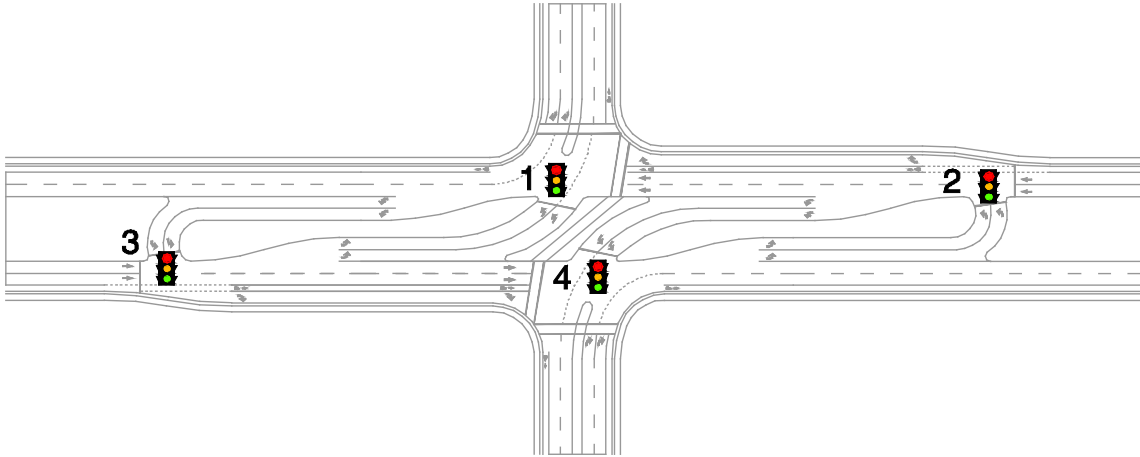

Exhibit 5-2. Signal placement at signalized RCUT intersection.

Bi-directional Progression

A key reason to install a signalized RCUT intersection is to improve signal progression on the main street. The RCUT intersection is the only at-grade design known at this time to enable each direction on a two-way arterial to operate independently. No movement crosses both directions of the major street, so there is no need for both directions of the major street to receive the same signal indication at the same time. Both directions can be progressed at any speed and at any signal spacing. The green band can be set equal to the length of the shortest green split along the arterial. This type of progression is usually only possible with progression in one direction on an arterial, or on a one-way street. Informally, it is sometimes referred to as “perfect progression” or “100-percent efficiency.” The other alternative intersection and interchange designs covered in these alternative intersection guides—MUT and DLT intersections—offer progression that is typically improved compared to conventional arterial corridors but not to the extent of a RCUT intersection.

Exhibit 5-3 shows progression on a RCUT arterial. Signals on one side of the arterial, A through F, are independent of the signals on the other side of the arterial, G through L. Each side of the arterial on a RCUT corridor effectively operates as a one-way street. Each side of the arterial can have its own cycle length and/or progression speed.

Restricted Crossing U-turn Informational Guide

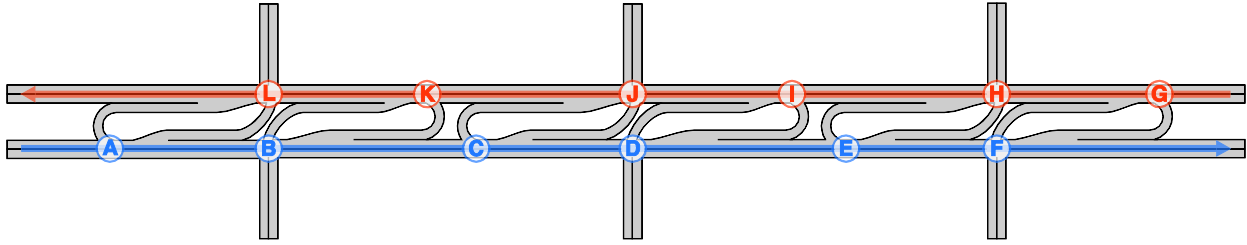

Direction	Parameter						
Right to left	Signal	F	E	D	C	B	A
	Distance from previous signal, ft	750	650	1000	700	600	Not applicable
	Offset to start of green, sec	74	59	46	26	12	0
Left to right	Signal	G	H	I	J	K	L
	Distance from previous signal, ft	Not applicable	600	850	1050	600	600
	Offset to start of green, sec	0	12	29	50	62	74

Note: Assumed progression speed of 50 feet per second (34 mph) in both directions

Exhibit 5-3 Signal progression on a RCUT corridor.

Signal offsets along a RCUT arterial depend primarily on the speed at which the operator chooses to progress traffic. If the operator wants to decrease the progression speed from signal A to B in Exhibit 5-3, for example, the offset of B relative to A can be increased. Like a one-way street, RCUT corridors offer the potential for speed control with signal timing without impacting coordination.

The independence of the signals on each side of a RCUT corridor and associated progression capabilities allow for signals to be added or relocated as traffic and land use patterns change with minimal impact on through arterial traffic.

Signals at RCUT intersections typically have two phase intervals, one for the main street and one for the crossover or minor street. At a signalized U-turn crossover that also serves a driveway or side street, a third dedicated signal phase interval is sometimes provided to serve traffic turning right out from the driveway or side street.

Cycle Length

Cycle lengths at RCUT intersections will generally be shorter than at comparable conventional intersections. This is because each signal will typically have only two phases and because longer

cycle lengths are not needed for desirable progression as they are in many conventional corridors with two-way progression. Shorter cycles reduce delay for most vehicles and for pedestrians crossing the arterial, even if the arterial crossing is in two stages.

Exhibit 5-2 showed the location of the four signals at a signalized RCUT intersection. To establish major street progression, there will almost always be progression from signal 2 to 1. This means signals 2 and 1 must have a common cycle length. Similarly, signals 3 and 4 must have a common cycle length and a means of communication between them.

Signal timing at a RCUT intersection or corridor is fundamentally different from any other intersection or corridor due to the ability to have different cycle lengths in each direction of the major street. Signal timing at a RCUT intersection or corridor can use a common cycle length in both directions of the major street or a different cycle length for each direction of the major street.

If a common cycle length in both directions is used, there is an opportunity to provide for some progression for the movements using the crossovers. This may also allow pedestrians to cross the arterial within one signal cycle. With different cycle lengths in each direction, arrivals in the crossovers would be random, most pedestrians would cross the major street in two stages (with a delay in the median), and minor street movements could not be progressed.

A common cycle length in both directions results in a cycle length less than optimum for each particular junction. For example, in Exhibit 5-2, the optimum cycle length for signals 1 and 2 in some design time period might be 80 seconds, while for signals 3 and 4 it might be 120 seconds. A compromise of 100 seconds for all four signals might introduce significant extra delay at all four signals. Using 80- and 120-second cycles would reduce delay values. Selecting a common cycle length in both directions requires considering the possible benefit from providing some progression at the crossover movements compared to the possible benefit from providing a cycle length in each direction that is optimal for the individual intersections. For a particular time of day and set of demands, signal timing software packages can help consider each method to compare the resulting performance.

A procedure for establishing progression with RCUT intersections with independent control in both directions includes the following steps:⁽³⁾

1. Use a standard signal timing method to determine the optimum cycle length at each signal
2. Select one common cycle length for each direction of the arterial and readjust the green times at the individual signals accordingly
3. Establish the arterial progression speed
4. Determine signal offsets based on the distances between signal-controlled intersections and the progression speed (e.g., the end of the major street green phase at one signal-controlled intersection relative to the end of the major street green phase of the adjacent signal-controlled intersection)

5. Adjust the offsets to allow for adequate start-up times to discharge standing queues and to provide progression possibilities for left-turning and U-turning traffic

Phasing

With a few exceptions, the RCUT intersection typically has two-phase signals. Exhibit 5-2 showed the four signal locations at a signalized RCUT intersection. One phase at each signal would serve major street through movements, while the second phase would serve crossover and/or minor street movements.

Manual signal optimization equations or signal optimization software are available to find optimum phase times for each signal at a RCUT intersection. The methods can be used for each time period of interest given basic input data like demands, speeds, and pedestrian crossing times. Richard Kramer, an early innovator in RCUT intersection applications, suggested the major street on a RCUT corridor should receive two-thirds to three-quarters of the cycle length as green.⁽¹⁾ If less than two-thirds of the cycle is provided for the major street, the minor street demands may be relatively too heavy for the RCUT intersection design. If more than three-quarters of the cycle is provided for the major street, the minor street demands may be too light for signals to be warranted.

Most two-phase signals at RCUT intersections have green ball indications for each direction. To reduce delay where sight distances and other site features are favorable, many agencies allow RTOR from the minor street or LTOR from a U-turn crossover. If LTOR is prohibited by law, but site conditions would otherwise allow it, a flashing yellow arrow indication is possible instead of a red ball. The two crossover phases would use a green arrow display for a protected turn and flashing yellow arrow for a permissive turn. NCDOT has used this treatment for several years at the left-turn and U-turn crossover signals of a RCUT intersection on US-421 just south of its junction with NC-132 in Wilmington. Traditionally, flashing yellow arrow treatments have been used for one-lane turn bays. However, the NCDOT has installed a flashing yellow arrow on a two-lane turn bay in Cary, NC.

In theory, a RCUT intersection signal could employ a third signal phase when a U-turn crossover is located at the same place as a driveway or a side street. The three phases would be:

1. The major street green ball
2. The driveway green ball, with perhaps a green ball signal for the U-turn crossover allowing permissive U-turns
3. The U-turn crossover green arrow protected movement

A three-phase signal at a U-turn crossover has recently been installed in Detroit, MI on Eight Mile Road just east of Woodward Avenue. Almost always, the driveway or side street demands do not justify the third phase and the extra delay it would introduce for all road users. U-turn crossover drivers generally understand they must yield to driveway or side street traffic and do so without conflicts. However, there are U-turn crossovers at MUT intersections in Michigan—such as along M-59 east of M-53 in Shelby Township, MI—where the driveway and side street demand has built up to the point that MDOT installed “Left Turn Yield on [green ball]” signs for

the U-turning traffic. Access management practices and flexible crossover placement help minimize the number of places where a third signal phase would be needed.

Signalized RCUT intersections with four approaches may use actuated signals. Detectors can be used in all of the crossovers, on the minor street approaches, and on the major street approaches.⁽³⁾ Exhibit 5-4 displays signal phasing for a RCUT intersection with each of the four signals operated by a dedicated controller.

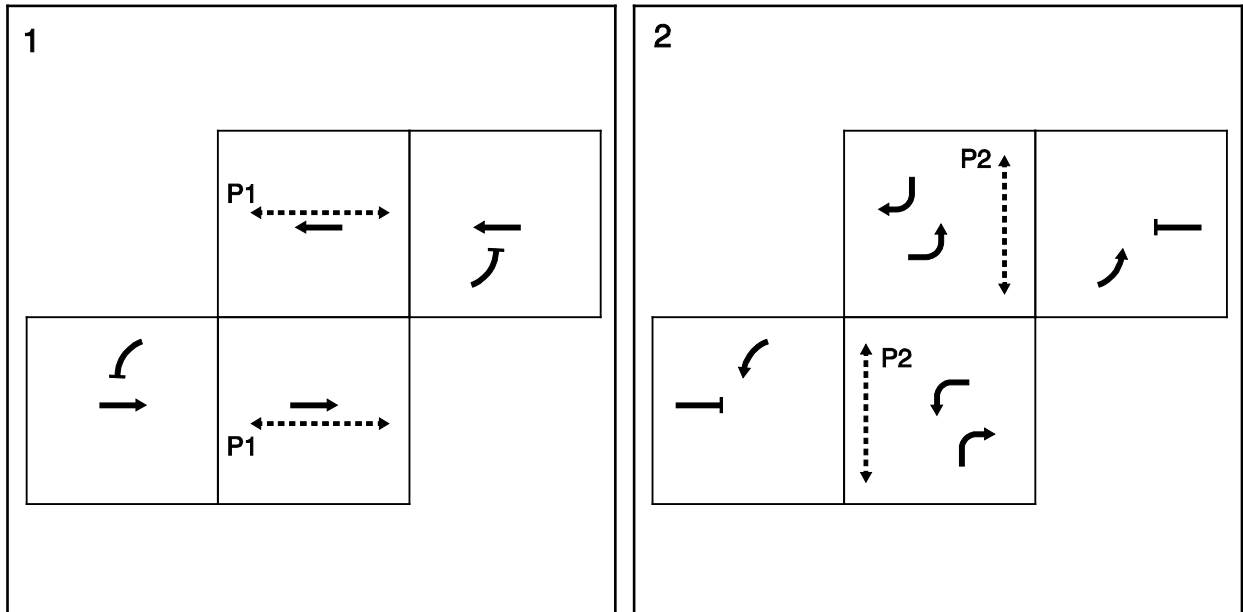

Exhibit 5-4. Signal phasing for a RCUT intersection with four controllers.

While not yet implemented, it is feasible to use one controller for the four signal locations. Exhibit 5-5 and Exhibit 5-6 show two possible signal phasing schemes. With just one controller, there is only one cycle length serving both directions of the arterial. Therefore, some additional delay may result compared to a plan with different cycle lengths in each direction of the major street.

The signal phasing schemes in Exhibits 5-5 and 5-6 include three main movements:

1. Major street through movements
2. U-turns
3. Left turns from the major street concurrent with right turns from the side street

These phasing schemes afford flexibility to accommodate junctions where there are unbalanced left-turn and/or U-turn volumes.

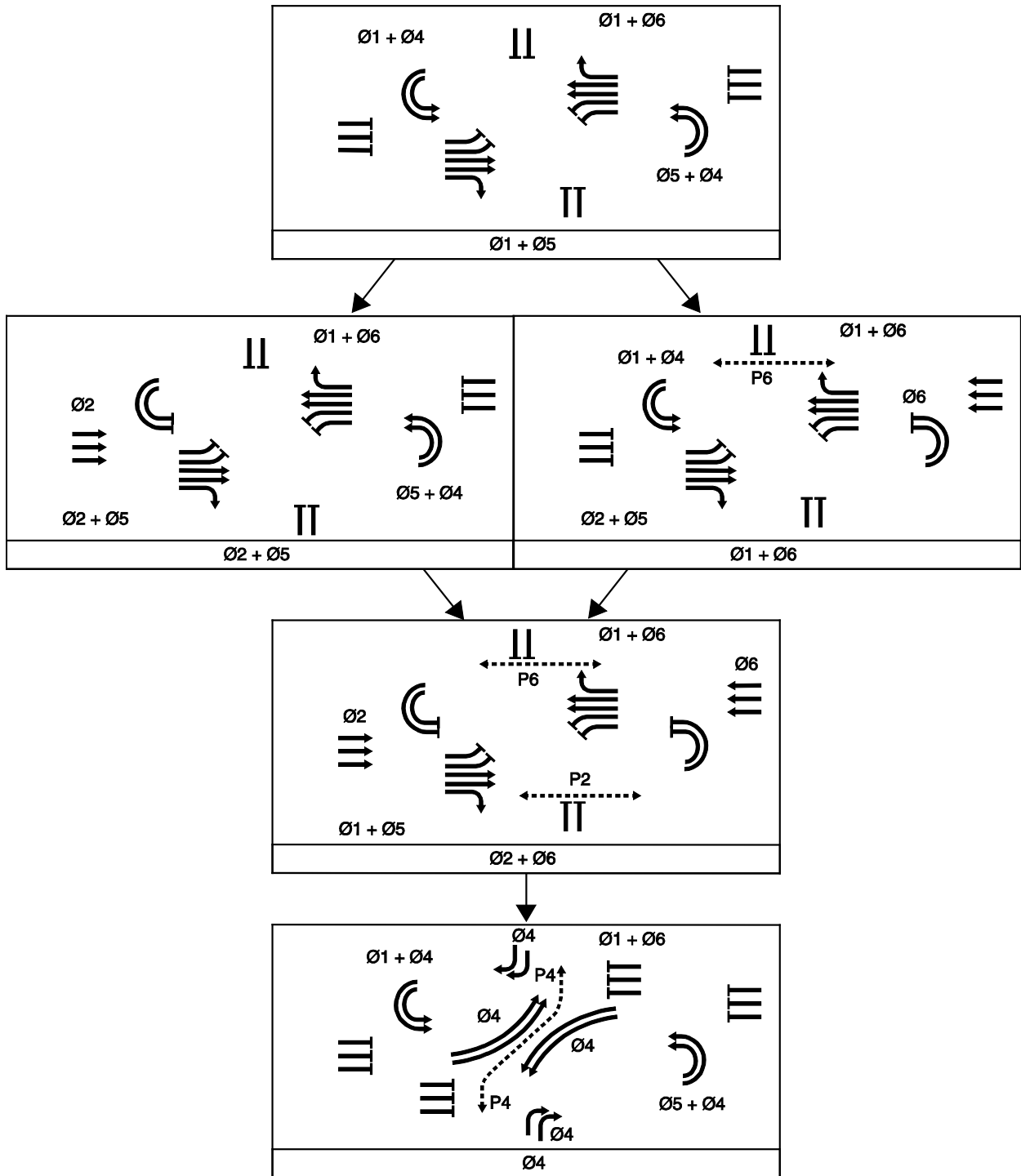

Exhibit 5-5. Signal phasing for a RCUT intersection with one controller and a single concurrent pedestrian phase to allow pedestrians to cross the major street.

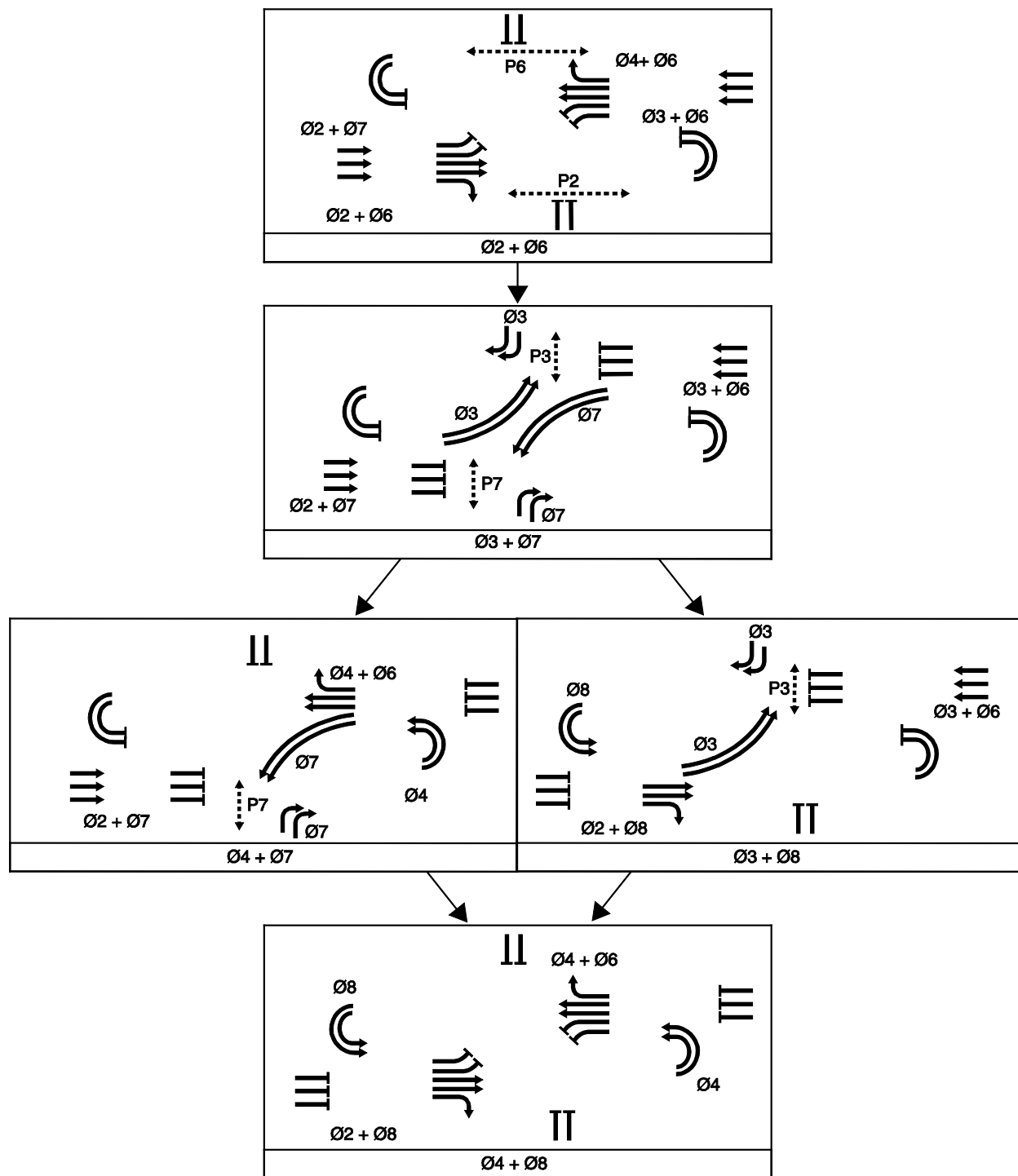

Exhibit 5-6. Signal phasing for a RCUT intersection with one controller in which pedestrians cross the major street at two separated signal-controlled crosswalks.

Exhibits 5-5 and 5-6 illustrate that pedestrians can cross the minor street approaches during the phases that serve major street through vehicles. Pedestrians can cross the major street approaches during the phases that serve major street left-turning vehicles. Providing a minimum green time to allow pedestrians to cross both major street legs during a single phase (i.e., a one-stage

crossing) could potentially create substantial delays for major street through volumes and eliminate bi-directional progression. However, a single-stage crossing may promote desired crossing actions by pedestrians. A multistage crossing presents additional challenges for visually impaired pedestrians. Regardless of the type of phasing used, the minimum green time for pedestrian crossings must be sufficient, based on the assumed walking speed of 3.5 feet per second from the MUTCD.⁽⁷⁾ As per PROWAG, audible pedestrian signals will be required at all new signals, including those at RCUT intersections.⁽²²⁾ More information on pedestrian considerations is provided in Chapter 3.

Split Times

A rule of thumb is for the main street at a RCUT intersection to receive two-thirds to three-quarters of the green time during a cycle. At anything under 60-percent of green time for the main street, other intersection designs will likely serve the relatively heavy minor street demand more efficiently. RCUT intersection designs allowing LTOR from the U-turn crossovers where legal, RTOR from the minor street, and/or permissive left turns from the left-turn crossovers (using a flashing yellow arrow signal) to minimize the need for green time for the minor phases. Major street minimum green times for serving pedestrians are also relatively short because major street pedestrian crossings almost always happen in two stages. That is, pedestrians wishing to cross the RCUT major street first wait for the “walk” signal to cross the first half of the arterial; this “walk” signal is concurrent with the minor street green. Once across the first half of the arterial, pedestrians cross the median and wait for a “walk” signal to cross the second half of the arterial; that “walk” signal is concurrent with the minor street green on that side of the arterial.

Offsets

Providing bi-directional progression along the major street is a typical objective of a RCUT intersection.

The following procedure could be used for establishing optimum offsets to attain progression in a RCUT corridor with different cycle lengths in each direction:⁽³⁾

1. Use a standard signal timing method to determine the optimum cycle length and phase times at each signal
2. Select one common cycle length for each direction of the arterial and readjust the green times at the individual signals accordingly
3. Establish the arterial progression speed
4. Determine signal offsets based on the distances between signal-controlled intersections and the progression speed (e.g., the end of the major street green phase at one signal-controlled intersection relative to the end of the major street green phase of the adjacent signal-controlled intersection)
5. Adjust the offsets to allow for adequate start-up times to discharge standing queues created by U-turning and minor street traffic

The following procedure could be used for establishing progression in a RCUT corridor with the same cycle length in both major street directions:

1. Use a standard signal timing method to determine the optimum cycle length and phase times at each signal
2. Select one common cycle length for both directions of the arterial and readjust the green times at the individual signals accordingly
3. Establish the arterial progression speed
4. Determine signal offsets based on the distances between signal-controlled intersections and the progression speed (e.g., the end of the major street green phase at one signal-controlled intersection relative to the end of the major street green phase of the adjacent signal-controlled intersection)
5. Adjust the offsets to allow for adequate start-up times to discharge standing queues created by U-turning and minor street traffic
6. For each of the minor street movements that one wishes to try to progress, adjust the offsets along the major street so that the minor street movement can progress, making sure to keep the relative offsets along the major street from step 5 undisturbed

The ability of a corridor with RCUT intersections to accommodate a conventional intersection within the signal system increases the possible range of applicability of the RCUT intersection design. A RCUT corridor could include a conventional intersection that allows left turns and/or through movements from the side street while generally preserving progression. The conventional intersection results in operations such that both directions of the main street of the RCUT intersection have the same signal cycle length and will lock in the offset values. Two-way progression along the arterial could still be attained.

Optimization

It is possible to manually time signals at a single RCUT intersection or in a RCUT corridor. Commercial signal timing software is sometimes helpful in more complex cases such as when trying to progress minor street movements. There are a few general considerations when applying commercial signal timing packages to time RCUT intersections.

- Out-of-the-box the software will not have incorporated any adjustments for unique RCUT intersection features such as U-turn saturation flows or unbalanced lane distributions.
- The usual measures of effectiveness the packages use to optimize and report may not be the suitable for RCUT intersections. As Chapter 6 discussed, a measure like control delay at an individual junction is helpful but does not reflect the more complex needs of multiple junctions at a RCUT intersection.

Commercial signal timing packages generally do not allow different cycle lengths for each direction of the major street. This may require running the software in a non-standard way, such as treating a RCUT intersection as a one-way street pair with some hypothetical distance between the two directions.

RCUT Intersection Capacity

RCUT intersections have a fairly rigid capacity that can be derived from basic traffic engineering relationships. At a RCUT intersection, there are three types of junctions: left-turn crossover, minor street right turn, and U-turn crossover. Of the three, the U-turn crossover is typically the capacity constraint of the entire RCUT intersection because it serves more movements (including redirected movements) than the left-turn crossover. Also, it is limited to two lanes in current professional practice in contrast to the minor street right turn which can be expanded to more than two lanes. The key to the derivation is using the rule of thumb that the main street should receive at least two-thirds of the signal cycle, meaning the U-turn crossover—which serves the minor street left-turn and through movements—receives no more than one-third of the cycle. The derivation is presented in the Appendix.

Exhibit 5-7 shows a plot of the feasible demand space for a signalized RCUT intersection based on the derivation described above. At minor street demands below 5,000 vpd, agencies should consider unsignalized RCUT intersections. For minor street demands of more than 25,000 vpd, there are most likely other alternative intersections such as a MUT or DLT intersection that would generally serve the minor street more efficiently.

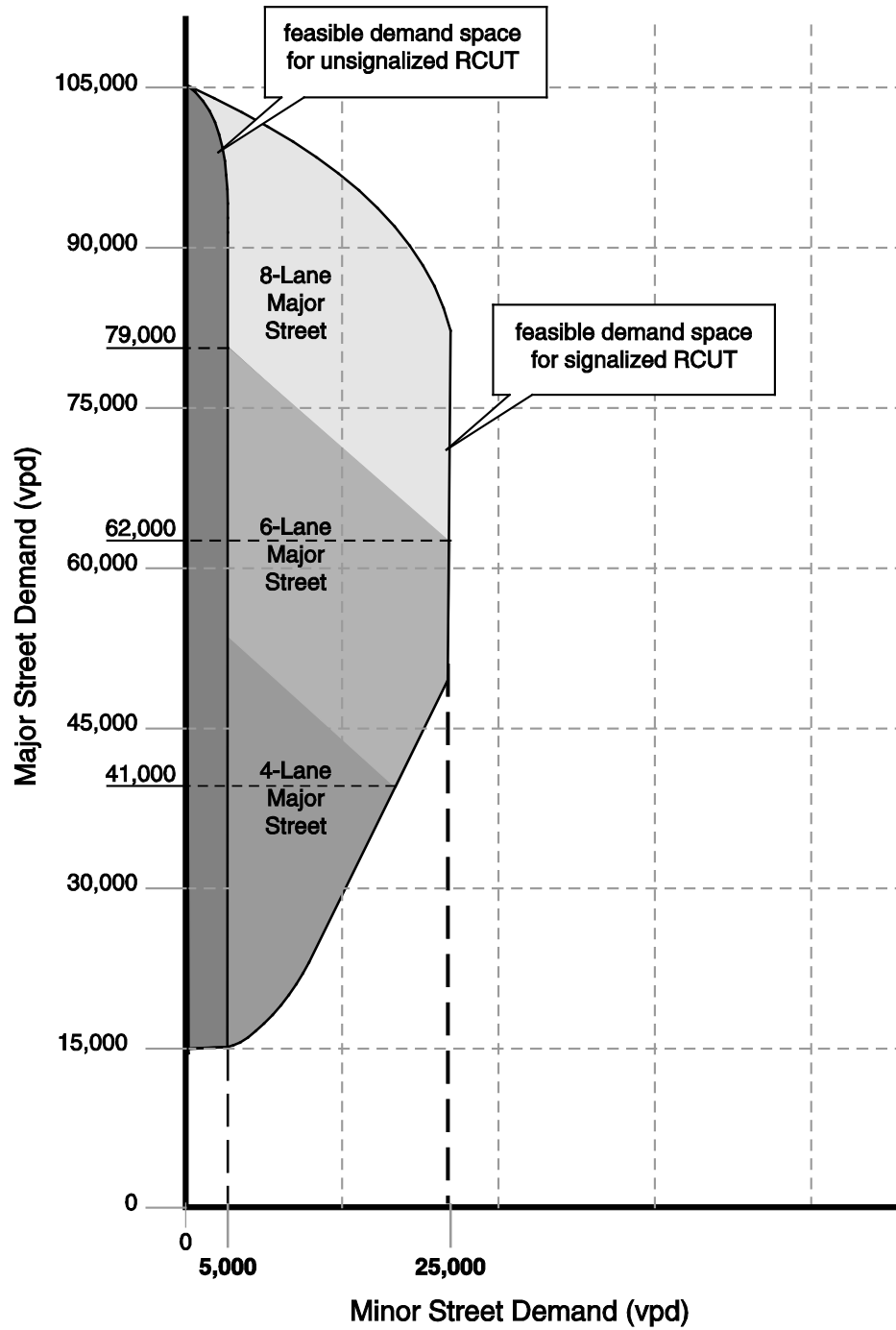

Exhibit 5-7. Feasible demand space for signalized RCUT intersection.

SYSTEM-WIDE CONSIDERATIONS

There are several system-wide factors to consider when looking at signalized RCUT intersections in comparison to conventional or other types of intersections. First and foremost, the primary purpose for installing a signalized RCUT intersection is to enhance signal progression along an arterial. RCUT intersections are therefore suited to corridors where a major street has several intersections with smaller minor streets, rather than at the junction of two major streets. RCUT intersections are likely to be more effective in a network of irregularly spaced intersections, where two-way progression is more difficult to achieve, rather than in a network of evenly-spaced intersections where a combination of the right speed and cycle length can produce good two-way progression with conventional intersections. These characteristics make RCUT intersections well-suited to areas with heavy demands in a linear pattern rather than a grid. The ability to independently progress traffic in both directions also makes RCUT intersections well-suited for arterials with near 50/50 directional splits during the peak periods. Exhibit 5-8 shows a corridor of RCUT intersections in Leland, NC.

As with any highway network or corridor with some movements that are relatively more efficient than others, travelers in an area with a RCUT corridor may find creative paths to avoid making a minor street left-turn or through movement if it decreases their overall trip time.

On the major street, a RCUT is high-capacity, “big pipe” intersection. As such, it has the ability to transfer bottlenecks elsewhere in a corridor if other capacity constraints are present. In those cases, corridor analysis is recommended rather than single intersection analysis and the network needs to be looked at as a whole. If several intersections downstream are evaluated, no overall system improvement may be seen, especially in travel times. Higher demands could activate downstream bottlenecks, which could be worse than the existing location before the RCUT was installed. FHWA is currently developing bottleneck identification and mitigation guidance and anticipates that guidance will be issued as a volume of the Traffic Analysis Toolbox.⁽³²⁾



Exhibit 5-8. RCUT corridor in Leland, NC.⁽⁴⁾

Corridors containing all RCUT signalized intersections could have bi-directional progression at any speed and any signal spacing, but those benefits can be realized on other corridors with some

compromises. A corridor or network can have multidirectional progression radiating out from a conventional intersection, as Exhibit 5-9 shows, with all signals operating on the same cycle.

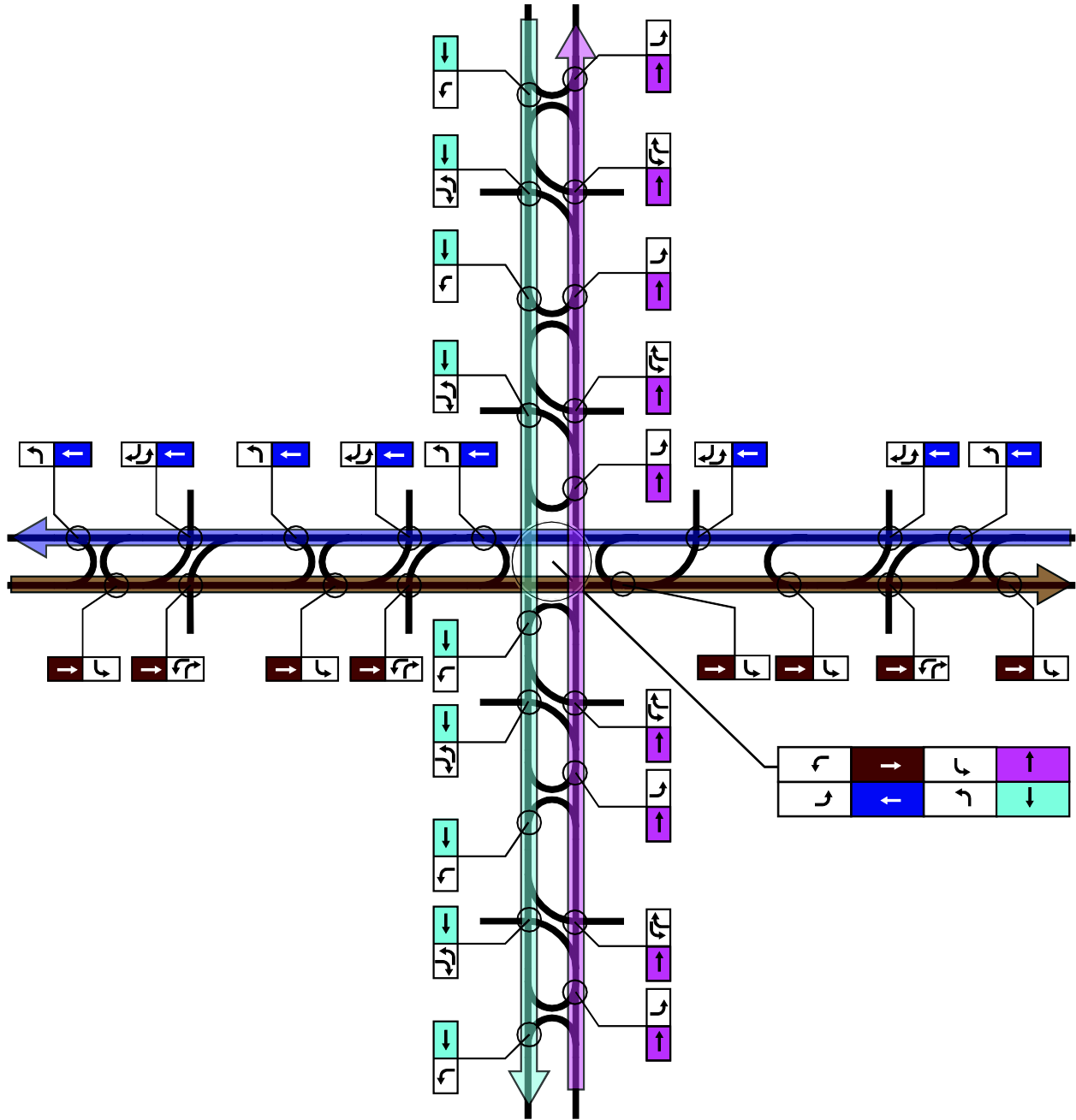

Exhibit 5-9. Progression in RCUT corridors radiating outward from one non-RCUT intersection.

Some of the progression benefits of a RCUT corridor can be achieved on a “hybrid” corridor of conventional signalized intersections and signalized RCUT intersections. Starting with an existing or planned corridor, agencies can develop a time-space diagram for the desired speed and cycle length. After manipulating leading and lagging left turns as needed, intersections along

the corridor supporting a wide band in both directions can be left to operate conventionally. Intersections where no feasible progression band exists in both directions can be converted to RCUT intersections.⁽³³⁾ Exhibit 5-10 illustrates the concept, and the steps are generally described as follows:

- Start with a reasonable cycle length and desired progression speed for the arterial and lay out progression bands in both directions
- Make small adjustments to the speed and cycle length to optimize timing
- Consider leading and lagging left turn phasing as needed
- Identify locations where progression in one direction or the other would be interrupted
- Consider RCUT intersections in those locations where the progression band was interrupted

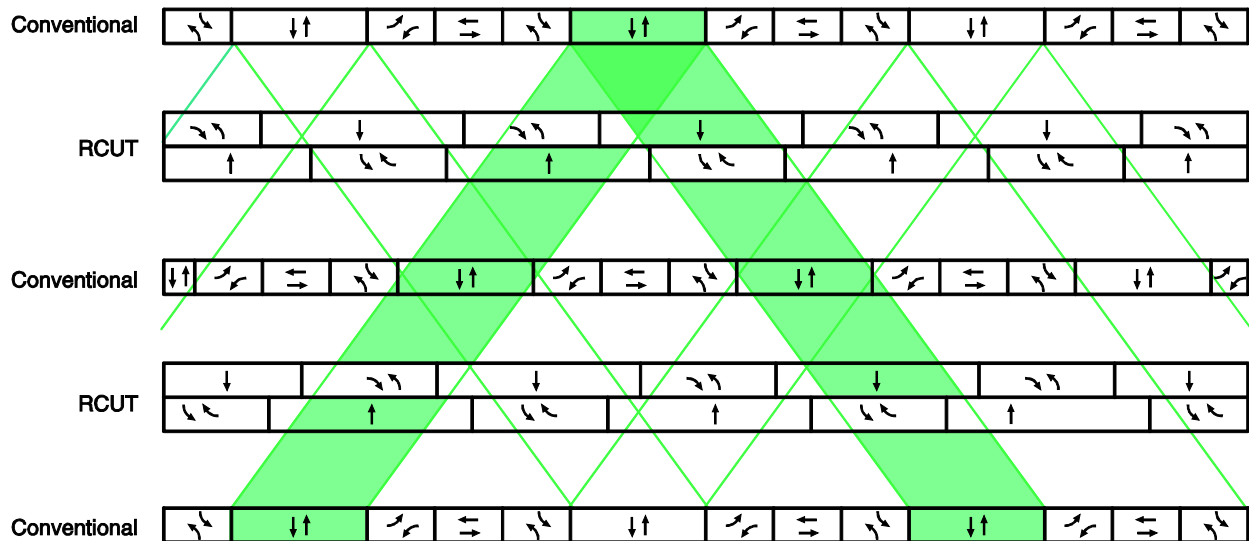

Exhibit 5-10. Corridor with RCUT intersections only where needed to provide two-way progression.

COMPARATIVE PERFORMANCE STUDIES

Several studies have compared signalized RCUT intersections to conventional intersections. They have generally found RCUT intersections to decrease delay and travel time compared to conventional intersections.

Research Prior to 2010

Kim et al. compared three signalized RCUT design cases under varying volumes to conventional intersection design.⁽³⁴⁾ Two of the RCUT design cases featured one U-turn lane and the other featured two U-turn lanes. With a RCUT intersection, travel time decreased by 30- to 40-percent and throughput increased 22- to 40-percent. The highest vehicle throughput for the one U-turn

lane design was achieved when green time on the minor road was 20-percent of the green time on the major road. In comparison, the RCUT design with two U-turn lanes experienced a smaller increase in vehicle throughput, ranging from 9- to 12-percent.

A simulation study of a Michigan corridor comparing the arterial operated as with TWLTL to MUT intersection operation also investigated RCUT intersection operation.⁽³⁾ Exhibit 5-11 shows the average results of the four time periods analyzed. During peak conditions, travel time on the RCUT corridor decreased 10-percent. In addition, travel speed was 15-percent higher than the same conditions using a TWLTL due to decreased intersection delay. During off-peak conditions, the study revealed that the RCUT intersection produced operations that were similar to TWLTLs.

Exhibit 5-11. RCUT simulation results, average of four time of day periods

Major Street Geometry	Total System Time, veh-hrs	Mean Stops Per Vehicle	Mean Speed, mi/h
TWLTL	251	1.75	19.6
MUT	208	1.94	24.4
RCUT	226	2.16	22.5

Simulation results using a range of intersection configurations and volumes from intersections in Virginia and North Carolina suggested mixed results in overall travel time when RCUT intersections were compared to traditional intersection designs. Travel time of the RCUT intersection compared to the conventional intersection ranged from -8-percent to +18-percent during off-peak conditions and -10-percent to +71-percent during peak conditions. The results were also mixed with respect to overall stops when compared to traditional intersection design. Stops with the RCUT intersection compared to the conventional intersection ranged from -8-percent to +187-percent during off-peak conditions and +16- to +146-percent during peak conditions.⁽³⁾

Simulation Results from 2010 AIIR⁽³⁾

The Alternative Intersections/Interchanges: Informational Report (AIIR) authors simulated five intersection lane configurations. The configurations ranged from a four-lane main street meeting a two-lane minor street with one-lane turn lanes and crossovers to a six-lane main street meeting a two-lane minor street with dual left-turn and crossover lanes. RCUT intersections and conventional intersections were simulated for each case, and the demand levels varied. Directional split on the major road ranged from 50:50 to 75:25, and the ratio of the minor road total volume to total intersection volume ranged from 0.12 to 0.40.

For all geometries tested, the throughput for RCUT intersections was 15- to 30-percent higher than comparable conventional intersections when the ratio of the minor road total volume to total intersection volume was in the range of 0.1 to 0.18. The throughput of the RCUT intersection became similar to the conventional intersection when the ratio of the minor road total volume to total intersection volume was in the range of 0.18 to 0.25. Beyond a 0.25 ratio of the minor road

total volume to total intersection volume, the conventional intersections had 5- to 17-percent higher throughput than RCUT intersections.

The pattern was similar for travel time. Simulation results indicated a 25- to 40-percent reduction in network travel time for RCUT intersections in comparison to conventional intersections when the ratio of the minor road total volume to total intersection volume was in the range of 0.10 to 0.15. The network travel times for the RCUT intersections became similar to the conventional intersections when the ratio of the minor road total volume to total intersection volume was in the range of 0.18 to 0.25. Beyond the ratio of the minor road total volume to total intersection volume of 0.25, the network travel time for the RCUT intersections increased from 15- to 25-percent in comparison to the network travel time for conventional intersections.

The results conclude RCUT intersections are best suited for intersections where the ratio of minor road total volume to total intersection volume is 0.25 or less.

Results from 2010 NCDOT Study⁽¹¹⁾

NCDOT sponsored a study of their RCUT intersections. Complete field data from the before periods were not available so simulation was used for the comparison. Simulations of the RCUT intersections were calibrated with field data collected at several signalized RCUT intersections. Simulations compared seven RCUT intersections to conventional intersections—five intersections in a corridor along US-17 in Leland, one intersection on US-421 in Wilmington, and one intersection with a unique geometry (no major street left-turn crossovers) on US-15/501 in Chapel Hill. The experiment used the same number of lanes at the conventional and RCUT intersections.

Six levels of demand were tested, which ranged from the 2009 peak-hour measured demands minus 40-percent to the 2009 peak hour measured demands plus 20-percent. In every case, travel time decreased with the RCUT intersection. The drop was over 100 percent at intersections on the US-17 corridor for demands above the peak. The drop was smallest for the two isolated RCUT intersections. The bulk of the travel time decrease was by major street through travelers, while right-turn and major street left-turn vehicles experienced little change, and minor street left-turn and through vehicles often had increased travel time. Overall, the NCDOT study confirmed NCDOT chose its RCUT locations well, RCUT intersections generally perform better in a corridor rather than in isolation, and main street through vehicles are the particular beneficiaries of RCUT intersections.

Field Measurements from Texas

In 2010, a 3.5-mile section of US-281 in an exurban area north of San Antonio with a 60-mph posted speed was converted from a four-lane divided conventional arterial to a four-lane RCUT corridor. Three four-approach signalized intersections were converted to RCUT intersections. A before-and-after study measured operational changes on US-281, including travel times, speeds, and traffic volumes on midweek days.⁽³⁵⁾ As shown in Exhibit 5-12, the RCUT intersections decreased travel time and increased travel speeds despite an increase in traffic volume.

Restricted Crossing U-turn Informational Guide

Exhibit 5-12. Operational measures on US-281 north of San Antonio before and after RCUT intersection installation.⁽³⁵⁾

Metric	Before RCUT	After RCUT
Southbound travel time (morning rush hour)	23.3 minutes	13.9 minutes
Southbound average speed (morning rush hour)	16 mph	20 mph
Northbound travel time (evening rush hour)	19.2 minutes	12.7 minutes
Northbound average speed (evening rush hour)	19 mph	29 mph
Traffic count (vehicles per day)	60,100 – 74,000	63,600 – 81,500

CHAPTER 6 — OPERATIONAL ANALYSIS

The previous chapter presented operational characteristics unique to RCUT intersections. Conducting an appropriate level of traffic operations analysis corresponding to the stage of the project development process will support decisions regarding the choice and design of a RCUT intersection. The level of analysis needs to be consistent with the available data, and that data needs to support the applied analysis tools. Vehicular traffic operations coincide with multimodal considerations. Final intersection configurations and associated signal timing should be in balance with multimodal needs for each unique project context.

A RCUT is a system of multiple intersections. As discussed previously in this guide, there are three types of RCUT intersections:

- Signal-controlled
- Stop-controlled
- Merge-controlled (with merges at the minor street right turns and U-turn crossovers and yield signs at the left-turn crossovers)

The main intersection is broken into two separate intersections on either side of a wide median. Operational analysis must consider the operations of each intersection and the relationship between all of the intersections.

Available data could include the following elements:

- Average daily traffic (ADT)
- Speed (posted, design, or 85th percentile)
- Weekday and weekend peak-hour turning movement counts
- Weekday and weekend off-peak turning movement counts
- Pedestrian volume at the intersection
- Bicycle volume at the intersection
- Proportion of the traffic stream composed of heavy vehicles
- Basic geometric data including distances between the main and crossover intersections

Measures of effectiveness are used to evaluate the operational efficiency of a particular design like the RCUT intersection. The FHWA Traffic Analysis Toolbox has identified the following seven basic measures of effectiveness for vehicles:⁽³²⁾

- Travel time: average time spent by vehicles traversing a facility, including control delay, in seconds or minutes per vehicle
- Speed: rate of motion (expressed in distance per unit of time)
- Delay: additional travel time experienced by travelers at speeds less than the free-flow (posted) speed (expressed in seconds or minutes)
- Queues: length of queued vehicles waiting to be served by the system (expressed in distance or number of vehicles)
- Stops: number of stops experienced by the section and/or corridor (based on a minimum travel speed threshold)
- Density: number of vehicles on a street segment averaged over space (usually expressed in vehicles per mile or vehicles per mile per lane)
- Travel time variance: a quantification of the unexpected non-recurring delay associated with excess travel demand (can be expressed in several ways)

The final two measures, density and travel time variance, are less applicable to an intersection treatment than an uninterrupted flow facility, but may still be considered during the operational analysis. While average speed and travel time apply to the RCUT intersection much like they would to a conventional intersection (as long as the analysis area includes the entire configuration), the delay and stops performance measures must be carefully aggregated over the multiple intersections contained within intersection. Individual performance measures such as queues, stops, and delay across multiple intersections of a typical vehicle progressed through the intersection provides more meaningful comparisons versus simply adding or averaging the performance measures from each intersection.

OPERATIONAL ANALYSIS OVERVIEW

According to FHWA's Traffic Analysis Toolbox, several tools are available to analyze traffic operations at intersections, including the following:⁽³²⁾

- Planning Level Analysis (such as critical lane volume and CAP-X)
- Highway Capacity Manual (HCM) Analysis
- Microsimulation Analysis

One major factor distinguishing these three types of analysis is the amount of time required to evaluate each scenario. HCM analysis may take several times as long as planning analysis, and microsimulation is typically an order of magnitude greater than HCM analysis. Planning-level tools are useful in the initial feasibility analysis and to conduct a high-level comparison of the approximate number of lanes for a RCUT intersection. An operational analysis using a deterministic method, such as the HCM, is useful to perform a more detailed peak-hour performance analysis and to estimate performance measures like delay, travel time, and queue

lengths. The HCM analysis may provide insight on additional geometric design and signal timing details. Microsimulation is useful for alternative intersection forms containing multiple closely-spaced intersections for which an HCM procedure has not been explicitly developed.

Exhibit 6-1 provides a summary of available analysis techniques for each type of RCUT intersection. Planning analysis is available for signal-controlled RCUT intersections, but rarely needed for stop-controlled and merge-controlled intersections because performing more detailed HCM procedures are only slightly more difficult to conduct. At the level of HCM analysis, it is currently possible to piece together a procedure for a signal-controlled RCUT from various HCM procedures, but requires making multiple assumptions.⁽⁶⁾ A FHWA-funded effort is underway to create an HCM operational analysis procedure specifically for RCUT intersections. HCM procedures for stop-controlled and merge-controlled RCUT intersections are currently feasible with HCM methods, and the FHWA effort will solidify procedures specifically for these types of RCUT intersections. Finally, microsimulation analysis is available for all three types of RCUT intersections, but is rarely needed for stop-controlled and merge-controlled RCUT intersections because those tend to be safety countermeasures in low volume environments where detailed operational results are not needed for decision-making. The following sections will detail each type of analysis.

Exhibit 6-1. RCUT Analysis Techniques

Type of RCUT	Available Techniques		
	Planning	Highway Capacity Manual	Microsimulation
Signal-controlled	Available using critical lane analysis and CAP-X	Difficult to perform now for motor vehicles; can analyze crossing pedestrians and bicycles. RCUT-specific HCM procedure under development	Can be performed for motor vehicles, pedestrians, and bicycles with most simulation packages
Stop-controlled	Possible to perform with HCM but rarely used	Possible to perform now; RCUT-specific HCM procedure under development	Can be performed but rarely needed
Merge-controlled	Possible to perform with HCM but rarely used	Possible to perform now; RCUT-specific HCM procedure under development	Can be performed but rarely needed

Exhibit 6-2 shows how to translate turning movements into RCUT intersection movements for main streets running north-south or east-west. Most analysis software designed for RCUT intersections (such as the CAP-X program described below) will make the translation automatically. Most microsimulation packages start with an origin-destination matrix rather than intersection-level turning movement data, but analysts using software not designed for RCUT intersections or making manual calculations will have to make the translations shown in Exhibit 6-2. Pedestrian and bicycle movements from a conventional intersection will also have to be converted for the RCUT intersection geometry before analysis.

Restricted Crossing U-turn Informational Guide

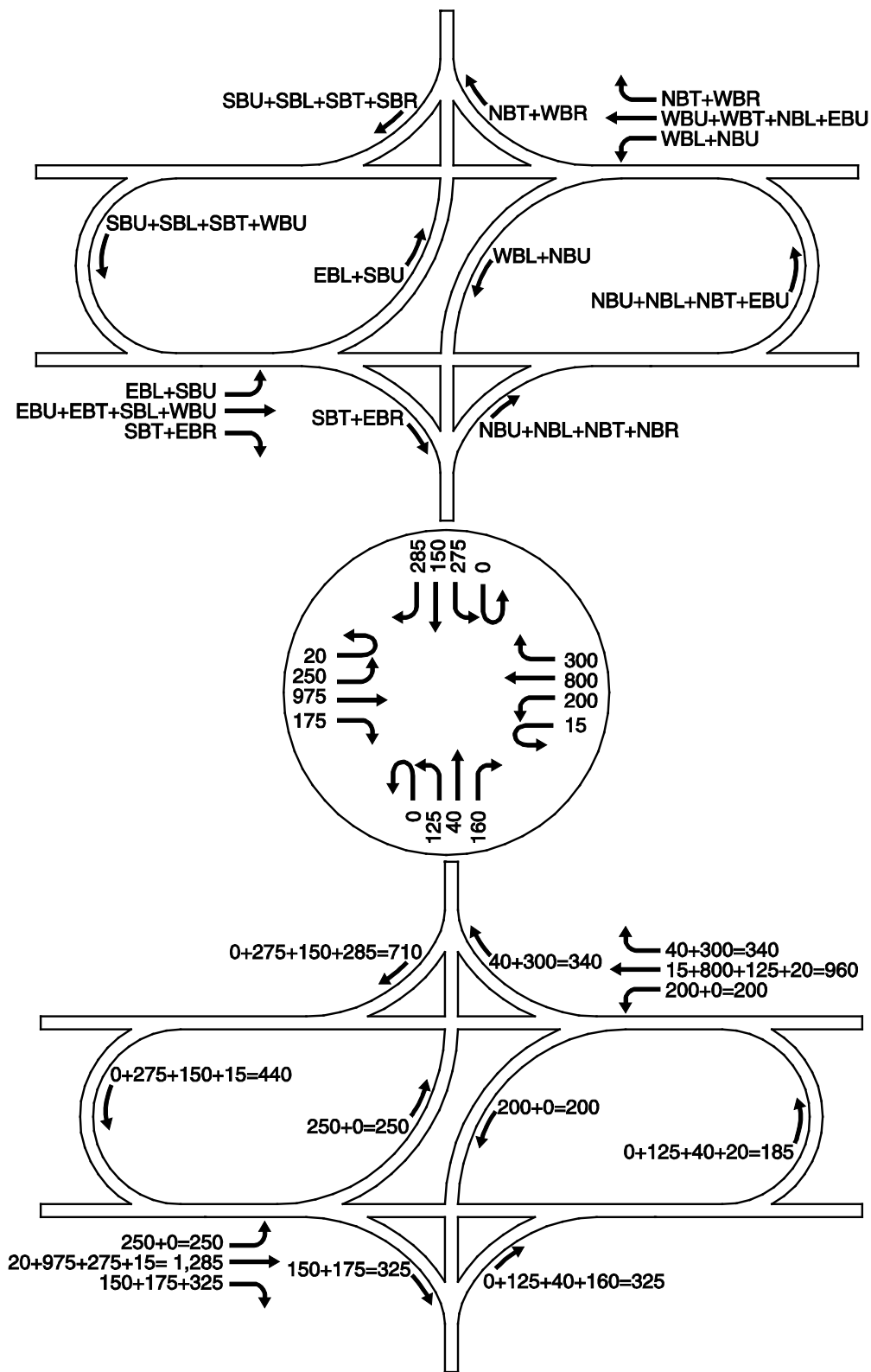

Exhibit 6-2. Translating turning movements at a conventional intersection into a RCUT intersection.

PLANNING ANALYSIS

As noted in Exhibit 6-1, it is possible to perform a planning analysis on stop-controlled or merge-controlled RCUT intersections. For stop-controlled RCUT intersections, this can be done using the planning analysis procedure for stop-controlled intersections described in the HCM for each of the six stop-controlled junctions to see if any are at or near capacity. For merge-controlled RCUT intersections, this could be done using the planning analysis procedure for stop-controlled intersections described in the HCM for each of the two yield-controlled crossovers to see if either is at or near capacity. This represents a conservative analysis, as a yield-controlled movement would have a higher capacity than a stop-controlled movement. Analysts can use the planning analysis procedure for two-sided weaves in the HCM as a check to see if any of the movements from the minor street to the U-turn crossover or from the U-turn crossover to the minor street are at or near capacity. Even at an early project development stage, most analysts are apt to choose to conduct HCM analyses of these types of RCUT intersections rather than planning analyses because the additional effort to do so is only incremental.

Most planning analyses of RCUT intersections are performed for signal-controlled cases. The classic calculation for the planning analysis of a signalized intersection, described in several editions of the HCM, is the critical lane analysis method. This is appropriate to apply to a RCUT intersection. The idea behind the method is that in the middle of any intersection is a key conflict point where two or more traffic streams compete for space and only one can possess it at any time. The conflict point with the highest volume to capacity (v/c) ratio will be “critical” to intersection performance. The highest v/c ratio at any point at an intersection is a useful predictor of overall intersection performance at the planning level, though more minor elements affecting capacity, such as some nuances of signal control and operational effects of geometrics, are not captured.

A step-by-step procedure for performing a critical lane analysis at an intersection with two, three, or four approaches is shown in the Appendix, along with an example. The procedure uses flow rates (demands during the peak 15 minutes expressed as vehicles per hour).

FHWA has developed a planning tool to conduct capacity analysis for planning of alternative intersections (CAP-X), described as “*a tool that can be used to evaluate selected types of innovative or alternative junction designs (8 intersections, 5 interchanges, and 3 roundabouts) using given peak hourly traffic counts.*”⁽³⁶⁾ Exhibit 6-5 is a screen capture from the spreadsheet that is downloadable from the Transportation Systems Institute website, *A Federal Highway Administration Project in partnership with the Transportation Systems Institute at the University of Central Florida*. Inputs include turning movement volume, percent trucks, truck adjustment, turn adjustments, and capacity. The user enters the number of lanes for each approach to each junction of the RCUT intersection on the results screen. The results screen shows the critical lane demand and demand to capacity ratio at each junction. Exhibit 6-3 shows the inputs for the example problem described above; the CAP-X results verify a critical lane demand of 1,167 vphpl at the northern U-turn crossover and a demand to capacity ratio of 0.69 at that point. CAP-X is a convenient way to perform a planning analysis on a RCUT alternative.









Capacity Analysis for Planning of Junctions						
Input Worksheet						
Project Name:	RCUT Guide					
Project Number:	Chapter 6					
Location:	Washington, DC					
Date:	March, 2014					
Traffic Volume Demand						
	Volume (Veh/hr)				Percent (%)	
	U-Turn 	Left 	Thru 	Right 	Truck	Volume Growth
Eastbound	0	150	420	10	0.00%	0.00%
Westbound	0	60	1900	50	0.00%	0.00%
Southbound	0	20	300	10	0.00%	0.00%
Northbound	0	30	100	200	0.00%	0.00%
Adjustment Factor	0.80	0.95		0.85		
Suggested	0.80	0.95		0.85		
Truck to PCE Factor				Suggested = 2.00		2.00
Critical Lane Volume				1700		
Equivalent Passenger Car Volume						
	Volume (Veh/hr)					
	U-Turn 	Left 	Thru 	Right 		
Eastbound	0	150	420	10		
Westbound	0	60	1900	50		
Southbound	0	20	300	10		
Northbound	0	30	100	200		
NOTES:						
Left-Turn Adjustment Factor	Conversion of left-turning vehicles to equivalent through vehicles					
Right-Turn Adjustment Factor	Conversion of right-turning vehicles to equivalent through vehicles					
U-turn Adjustment Factor	Conversion of U-turning vehicles to equivalent through vehicles					
Truck to PCE Factor	1 truck = X Passenger Car Equivalents					
Critical Lane Volume Sum Limit	Saturation Value for Critical Lane Volume Sum at an intersection					

Exhibit 6-3. CAP-X planning level tool screen capture.⁽³⁶⁾

HIGHWAY CAPACITY MANUAL (HCM) ANALYSIS

Stop-Controlled RCUT

Analysts can perform macroscopic analysis of the individual junctions at a stop-controlled RCUT intersection using the 2010 HCM and software that implements its methods.⁽⁶⁾ This produces a set of results showing whether any of the junctions are near- or over-capacity, and would provide delay and level of service (LOS) for each movement at each junction. For the

minor street left turns and through movements, there would be two sets of performance measures: one at the main junction and one at the U-turn crossover. Having two sets of performance measures creates challenges when comparing a RCUT intersection to a conventional intersection.

For example, is a minor street left turn at a RCUT intersection operating at LOS B and C at the two junctions performing better than a minor street left turn at a conventional intersection operating at LOS E? LOS at stop-controlled intersections is based upon control delay, so the two RCUT intersection delay estimates can be added and compared to the delay estimate for a single movement at a conventional intersection. However, for the RCUT intersection, the minor street left-turning vehicle experiences extra travel time to the U-turn crossover and back, which is not accounted for in this type of comparison. In summary, current macroscopic methods can be helpful in examining a stop-controlled RCUT intersection but there is a need for a procedure accounting for all aspects of operation.

FHWA has commissioned a research team to develop a macroscopic operational analysis procedure for RCUT intersections to appear in the next update of the HCM. The thoughts below are based on the early progress of that research. Information provided below is in draft form and is subject to change by the time the next update of the HCM is published (scheduled for 2015).

The operational measure of effectiveness (MOE) for a stop-controlled RCUT intersection in the next edition of the HCM will likely be a form of extra travel time compared to a conventional intersection. Setting aside U-turn demands, eight of the 12 movements at a four-approach RCUT intersection are unchanged from a conventional intersection, so the techniques of Chapter 19 of the 2010 HCM will apply to them without change. Only the minor street left turns and minor street through movements would use the new MOE.

The research team has concentrated on two aspects of the Chapter 19 procedure that may differ for RCUT intersections:

- Gap-acceptance behavior of motorists at U-turn crossovers
- Travel time for minor street left-turning and through vehicles from the main junction to the back of the queue at the U-turn crossover and from the U-turn crossover stop bar back to the main junction

Early indications suggest gap acceptance behavior is similar to corresponding conventional movements in the 2010 HCM, and the free-flow speed is a reasonable predictor of travel time from the main junction to the U-turn crossover and back again.

An interim step-by-step procedure for the HCM analysis of a stop-controlled RCUT intersection, until publication of the next edition of the HCM, is presented in the Appendix.

Merge-Controlled RCUT

RCUT intersections with yield signs or merges at the minor street right-turn and/or the U-turn crossover create a two-sided weave (from right to left) between the minor street and the U-turn crossover and another two-sided weave (from left to right) between the U-turn crossover and

minor street. Most of these installations are safety countermeasures at low volume locations where operational concerns are minimal.

RCUT intersections with merges present unique challenges for operational analysis, and there is no readily applicable analysis method in the 2010 HCM that can be applied.⁽⁶⁾

Signal-Controlled RCUT

As at stop-controlled and merge-controlled RCUT intersections, there is no current HCM analysis procedure available for signalized RCUT intersections. However, FHWA-sponsored research is underway to create such a procedure for the next edition of the HCM. It is possible to piece together a procedure from other parts of the HCM. This section provides guidance on how to conduct a HCM analysis of a signalized RCUT intersection from the information that is currently available, including the FHWA research project. Some parts of the procedure recommended here may change when the RCUT intersection-specific HCM procedure is published.

The Measure of Effectiveness (MOE) for an operational analysis of a signal-controlled RCUT intersection in the forthcoming HCM procedure will likely be a form of extra travel time, comparing the travel time a movement would have experienced using a direct path without traffic control to the travel time the movement experiences making its way through the RCUT intersection. Unlike stop-controlled RCUT intersections, most movements at a four-approach signal-controlled RCUT intersection behave differently from a conventional intersection because they progress through at least two signals. This is a reason for the use of extra travel time as the MOE for signalized RCUT intersections.

No decisions have yet been made on a recommended LOS scale. The options include using the current LOS scale from Chapter 18 of the 2010 HCM (with 80 seconds of control delay as the LOS F threshold) or establishing a scale with a higher LOS F threshold.

Inputs for a signal-controlled RCUT intersection include the turning movement count, geometry (numbers of lanes on each approach), distances from the main intersection to the U-turn crossovers, lengths of the storage bays for each crossover, and free-flow speed on the main street. Signal timing parameters are also needed, particularly some measure of the quality of progression along the major street, as that is the reason many signalized RCUT intersections are built.

The FHWA research developing an operational analysis procedure for signalized RCUT intersections is concentrating on several elements of the existing signalized intersection procedure in Chapter 18 that may differ for RCUT intersections. These elements include:

- Saturation flow rates in U-turn crossovers
- Lane utilization at multilane right turns or U-turn crossovers
- Left turn on red (LTOR) and right turn on red (RTOR) critical headways and follow-up times
- Travel times from main intersection to crossover and back

Exhibit 6-4 describes the preliminary findings from the FHWA research usable in the interim until publication of a new operational analysis procedure.

Exhibit 6-4. Preliminary guidance from FHWA research on key parameters in operation analysis of signalized RCUT intersections.

Parameter	Preliminary Guidance
Saturation flow rates in U-turn crossovers	Use adjustment factor of 0.8 for typical one-lane crossovers and 0.9 for typical two-lane crossovers; use adjustments above 0.9 or below 0.8 if turn radius is particularly large or small.
Lane utilization at multilane right turns or U-turn crossovers	For unsaturated movements, use lane distributions proportional to downstream movements. For example, if two-thirds of the vehicles using a dual lane U-turn crossover are minor street through vehicles and one-third are minor street left turn vehicles, for analysis place two-thirds of the crossover volume in the outside lane and one-third in the inside lane.
LTOR and RTOR critical headways and follow-up times	Use the same critical gap and mean follow-up times as in the 2010 HCM Chapter 19 for minor street right turns. ⁽⁶⁾
Travel times from main intersection to crossover and back	Use travel times based on the measured main street free-flow speed multiplied by the distance from the minor street to the U-turn crossover. Note that accelerations and decelerations are already accounted for in the control delay estimation formulae for each signalized junction.

An interim step-by-step procedure for the operational analysis of a signalized RCUT intersection, until publication of the next edition of the HCM, is presented in the Appendix.

The techniques in Chapter 18 of the 2010 HCM may be used to compute LOS for pedestrians and bicycles crossing RCUT intersections. The application is straightforward, with a LOS being generated for each crossing stage negotiated. For example, a pedestrian walking along one side of the minor street and crossing the major street would cross the minor street first, then one half of the major street, then the second half of the major street, so three separate levels of service would be generated. To get an overall travel time for any pedestrian or bicycle crossing movement would entail adding the delays estimated at each stage of the crossing to the extra time because of the median width and because the crossing may be at an angle other than 90 degrees.

MICROSIMULATION ANALYSIS

Microsimulation can be an effective tool to study RCUT intersections. Microsimulation programs create individual simulated vehicles and move them through a network, governed by fundamental equations of traffic flow, at small time increments such as 0.1 seconds. Simulation provides greater flexibility to examine unusual cases and networks, a distribution of responses rather than a single response value, and animation. A practitioner can simulate multiple modes, including passenger cars, heavy vehicles, light rail, pedestrians, and bicycles. Simulation is plausible for all three types of RCUT intersections—stop-controlled, merge-controlled, and signalized—but is rarely employed for stop- and merge-controlled RCUT intersections. Stop-

and merge-controlled RCUT intersections are typically safety countermeasures and operation analysis is less relevant.

There are several drawbacks to simulation. Input is more detailed than planning or HCM analyses, making it time-consuming to gather and code. Simulation programs are more complex and expensive to purchase than planning or HCM analysis software, and require trained or experienced users. The output is voluminous and requires post-processing to compute meaningful performance measures. Simulation studies do not necessarily produce higher quality results than planning or HCM studies; if agencies employ simulation, they must ensure programs are used properly in order to achieve useful results.

Many microsimulation efforts need to be calibrated for the special conditions of RCUT intersections. Calibration is the process of adjusting the governing traffic flow equations so simulation results match field conditions as closely as needed to achieve study objectives. A discussion on the calibration process can be found in the FHWA's Traffic Analysis Tools website in Volumes III or Volume IV (specific to CORSIM).⁽³²⁾

A 2010 research effort sponsored by NCDOT was the most comprehensive effort undertaken at the time of this writing to calibrate a VISSIM microsimulation model for RCUT intersections.⁽¹¹⁾ The researchers collected field data from four intersections with 12 possible travel patterns (left, through, and right at each leg of the intersection) for a total of 48 movements. The researchers combined the travel times for each of the 48 movements from four intersections at three sites and calibrated the models based on the mean percent difference in travel time between field and simulation to achieve a set of calibration parameters that was the best for the sites collectively.

Parameters adjusted in VISSIM to try to achieve an acceptable fit to the field data were:⁽¹¹⁾

1. The mean value of the main street free-flow speed distribution (the shape of the distribution was input as equivalent to the field measurements and kept constant throughout calibration)
2. The sizes of the speed zones for all turns
3. Increased conflict areas for minor street RTOR
4. Added desired speed decisions for minor roads
5. Adjusted gap values for all RTOR and for the flashing yellow arrow signals that were employed at the Wilmington site for permissive turns from all crossovers

Gap values from the study sites are shown in Exhibit 6-5.

Restricted Crossing U-turn Informational Guide

Exhibit 6-5. Final gap values after calibration.⁽¹¹⁾

SITE	RTOR		U-turn (flashing yellow)		Major left (flashing yellow)	
	Front gap (sec)	Rear gap (sec)	Front gap (sec)	Rear gap (sec)	Front gap (sec)	Rear gap (sec)
Chapel Hill	2.0	3.6	N/A	N/A	N/A	N/A
Wilmington	2.0	3.6	3.0	7.1	2.0	5.5
US-17	2.5	3.6	N/A	N/A	N/A	N/A

The overall lessons from the NCDOT calibration and validation effort were that calibration of a VISSIM model to the RCUT intersection design is possible; however, the effort was extensive. Agencies needing to calibrate their own simulation model to local RCUT corridors need to be aware that this is a complex and time-consuming undertaking.

This page intentionally left blank.

CHAPTER 7 — GEOMETRIC DESIGN

This chapter describes the typical RCUT intersection design approach and provides guidance for geometric features. It requires input from the multimodal considerations (Chapter 3), safety assessment (Chapter 4), and traffic operational analysis (Chapters 5 and 6). The guidance in this chapter is intended to supplement national resources on intersections that apply basic design principles.

Geometric design is similar for RCUT intersections with stop signs and with traffic signals, and RCUT intersections with stop signs can be converted to signalized RCUT intersections. The geometric design of signalized RCUT intersections makes up the bulk of the discussion in this chapter. RCUT intersections with merges have unique design and operational considerations and are also discussed. In this chapter, unless specifically referring to a RCUT intersection with merges, the discussion is intended to apply to RCUT intersections with stop signs or traffic signals.

DESIGN APPROACH

The geometric design of a RCUT intersection requires a series of key decisions, some of which are the same as for a conventional intersection and some of which are different. Unlike other alternative intersections, such as the MUT and DLT, the RCUT intersection is not discussed as an explicit concept in the current edition of the AASHTO Green Book.⁽⁵⁾

Developing the geometric layout for an intersection configuration requires considering the relationship and interaction of safety, operations, and design. The overarching goal is to provide geometry that meets the expectations of all road users. This includes appropriate channelization that is supplemented with signing and pavement markings. As with any intersection form under consideration, undesirable geometry cannot necessarily be mitigated by signing and pavement markings. Exhibits 7-1, 7-2, and 7-3 highlight the characteristic features of the three types of RCUT intersections.

Restricted Crossing U-turn Informational Guide

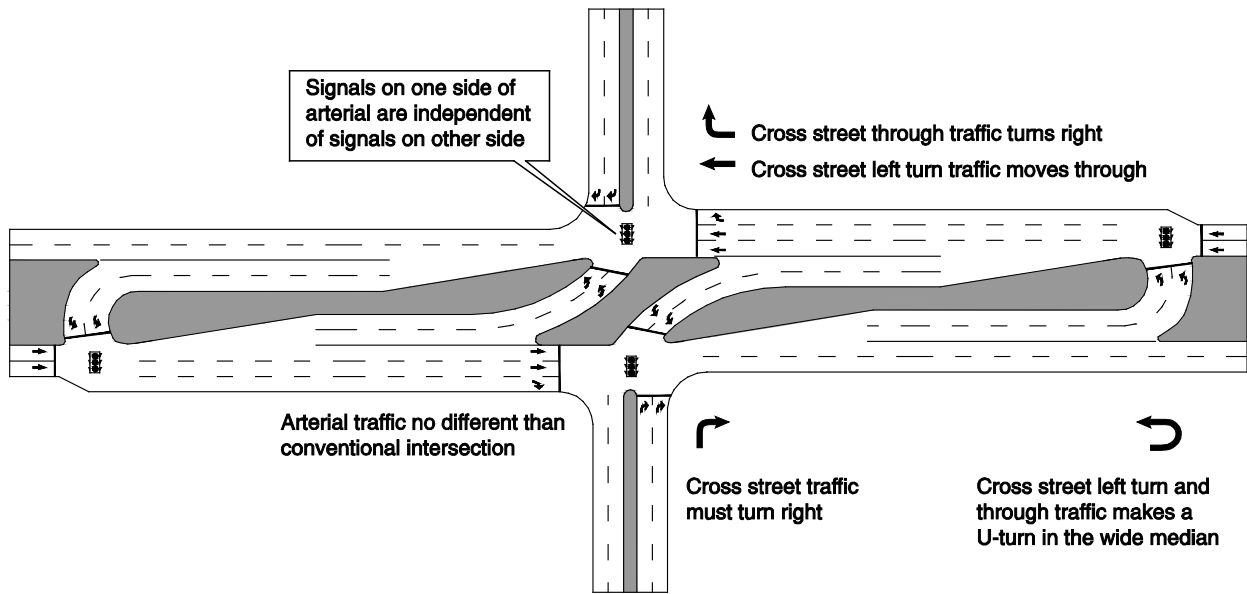

Exhibit 7-1. Characteristics of a RCUT intersection with signals.

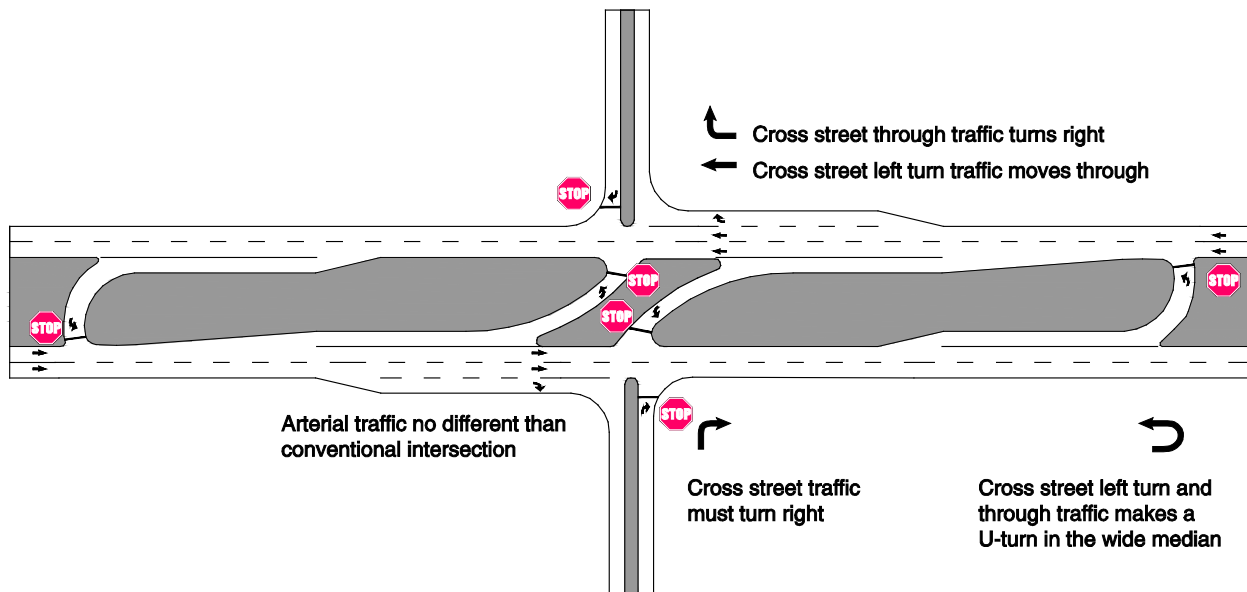

Exhibit 7-2. Characteristics of a RCUT intersection with stop-control.

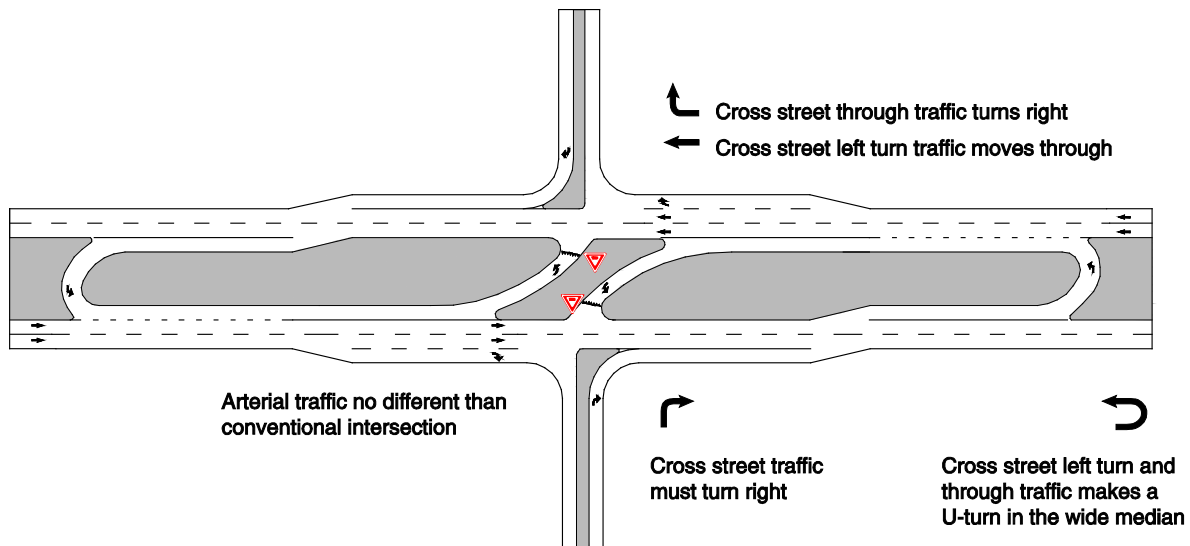

Exhibit 7-3. Characteristics of a RCUT intersection with merges.

The design of and RCUT intersection should begin with some basic information on the number of approaches, through lanes, intersection angle, typical design parameters, turning movement demands in the design hour, and provisions for pedestrians and bicycle facilities. At an early stage in the design, a planning-level capacity analysis (described in Chapter 6) will aid designers in determining the number of lanes required at each crossover. The crossovers are typically designed with one lane only for RCUT intersections with stop signs and with merges.

Another early design decision is the RCUT intersection width and length. RCUT width is influenced by the median width and of placing storage lanes heading into the crossovers back-to-back or side-by-side. There are a number of considerations influencing the median width. RCUT length is affected by the decision of where to place the U-turn crossovers. The considerations for each of these decisions are described in detail below.

As with all intersection design, the needs of pedestrians, bicycles, transit vehicles and users, and other special vehicles can influence the intersection geometrics. To date, most constructed RCUT intersections with merges and with stop signs have been in rural, undeveloped areas with no surrounding pedestrian and bicycle activity or facilities. Therefore, these RCUT intersections have not provided pedestrian, bicycle, or transit facilities. However, a flexible geometric configuration is one that could be readily converted to serve those user needs.

There are several geometric design and operational features that can affect the layout and operations of a RCUT intersection. A shorter cycle length (without violating the need for minimum pedestrian crossing times) may result in shorter average queues, which may allow for shorter storage bays and a shorter distance from the main intersection to the U-turn crossover. The shorter distance required may reduce travel times for minor street left-turning and through vehicles and improve vehicular levels of service. Short cycle lengths and closer spacing of the u-turn crossover will also generally be beneficial to pedestrians (reduced delay) and bicyclists (shorter travel distance if riding in the roadway).

GEOMETRIC DESIGN PARAMETERS/PRINCIPLES

The geometric design of a RCUT intersection introduces some unique design principles that are not typically present at a conventional intersection. These principles include:

- A wide median can make accommodating U-turn movements easier or more straightforward. Typically this median is uniform through the intersection and main crossing street, but there are design variations that reduce the length of the wide median or locate the median on the minor street. Bump-outs or loons can also be used to compensate for narrower median widths, yet still accommodate the U-turn movements.
- A large enough vehicle path at the U-turn crossover to accommodate trucks and allow for more efficient movements through the U-turn by passenger vehicles.
- Design elements that provide positive guidance using design elements and signage to reduce chances of driver error or the ease of illegal turns.
- Signing, marking, and geometric design that promotes safe and efficient movements that would otherwise be unexpected or not familiar to motorists.
- Corridor-wide access strategies and management considerations to properties along the median street to promote safe and efficient access to these properties.
- Stopping sight distance at all points through the intersection and intersection sight distance for all movements at each RCUT intersection junction. Intersection sight distance must be provided if RTOR movements, LTOR movements, or permissive movements are allowed.

The parameters and principles of geometric design for a RCUT intersection are similar to the principles for any other intersection design. In most cases, a RCUT intersection will consist of a principal arterial intersecting a minor arterial or collector road. The design principles outlined in the AASHTO Green Book for those facility types may generally be applied.⁽⁵⁾

A RCUT intersection is channelized to allow certain movements through the major street median at specific locations. The AASHTO Green Book provides principles and design details for channelization applicable to RCUT intersections.⁽⁵⁾

RANGE OF RCUT CONFIGURATIONS

A wide range of RCUT intersections configurations are possible. Many of the locations from a land use standpoint have not incorporated pedestrian and bicycle facilities into the RCUT intersection design. However, as discussed in Chapter 3 and throughout this Guide, it is important for a designer to understand the context of the intersection and integrate all users. A summary of the range of RCUT configurations are shown below.

1. Major streets can range from four lanes to eight lanes wide. Some corridors in Michigan have MUT intersections on ten-lane major streets that could be converted to the RCUT intersection design within the existing right-of-way.

2. Minor streets at a RCUT intersection can be up to four through lanes wide.
3. U-turn crossovers can be one or two lanes wide, while left-turn crossovers could range from one to three lanes wide.
4. The distance from the main intersection to the U-turn crossovers can vary from 400 feet for a stop- or signal-controlled RCUT intersection to one-half mile for a merge-controlled RCUT intersection.
5. The major street right-of-way could be as narrow as 70 feet with four 10-foot travel lanes, a 10-foot median providing room for left-turn crossovers and pedestrian staging, and 10-foot buffers on either side. The buffer could include curb and gutter, berms, and sidewalks.
6. An eight-lane major street with a generous median width could have as much as a 200-foot right-of-way.
7. RCUT intersections with merges that accommodate large trucks making U-turns would need either a wider median or loons sized to accommodate the truck U-turns.
8. A RCUT intersection may have three or four approaches.

Exhibit 7-4 shows a typical stop-controlled RCUT intersection in a rural area near Southern Pines, NC. This location has a high-speed four-lane major highway, a two-lane minor road, and one-lane crossovers. Due to the rural context there are no pedestrian, bicycle, or transit facilities at this location.



Exhibit 7-4. Stop-controlled RCUT intersection on US-1 near Southern Pines, NC.⁽²⁾

Exhibit 7-5 shows a typical merge-controlled RCUT intersection in a rural area in Emmitsburg, MD. This location has a high-speed four-lane major highway, a two-lane minor road, and one-lane crossovers. Due to the rural context there are no pedestrian, bicycle, or transit facilities at this location.



Exhibit 7-5. Merge-controlled RCUT intersection on US-15 in Emmitsburg, MD.⁽³⁾

Exhibit 7-6 shows a signalized RCUT intersection with a six-lane major highway in a suburban area outside Hamilton, OH. This location has a four-lane minor street and two-lane U-turn crossovers. Two minor street lanes are designated for U-turn crossover, and one lane is designated for a right turn to continue on the major street. Due to the suburban location, there are no pedestrian, bicycle, or transit facilities.



Exhibit 7-6. Signalized RCUT intersection on OH-4 outside Hamilton, OH with six-lane major highway and four-lane minor road.⁽²⁾

Exhibit 7-7 shows a signalized RCUT intersection in a suburban area with a six-lane major street and a four-lane minor street in Troy, MI. It includes a mix of one-lane and two-lane crossovers. There are pedestrian crosswalks at the main intersection along the major street and a pedestrian crosswalk of the major street on the left side of the photo.



Exhibit 7-7. Signalized RCUT intersection on Big Beaver Road in Troy, MI with six-lane major street and four-lane minor street.⁽³⁾

Exhibit 7-8 shows a RCUT with three approaches. This type of RCUT configuration reduces conflict points compared to one with four approaches (refer to Chapter 4 for more details).

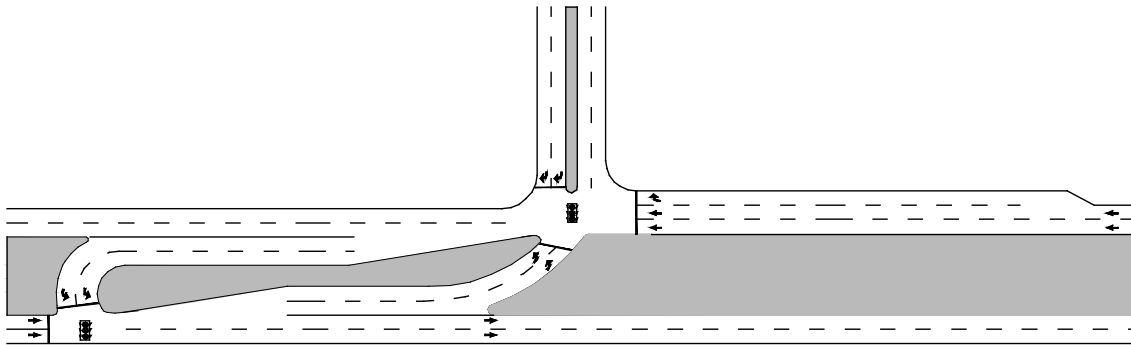

Exhibit 7-8. RCUT intersection with three-approaches.

OPERATIONAL EFFECTS OF GEOMETRIC DESIGN

This section addresses the operational effects of geometric design on safety performance and traffic operations. Examples of the operational effects of geometrics at RCUT intersections include:

1. The distance from the main intersection to the U-turn crossovers affects minor street left-turn and through vehicle travel times, which are a strong measure of operational effectiveness.
2. The radii of turning movements affect saturation flow rates. The smaller the radius, the slower the vehicle makes the turn and the lower the saturation flow rate. RCUT intersections with narrow medians and no ability for U-turning vehicles to turn onto a shoulder may result in low saturation flow rates. However, small turning radii may benefit crossing pedestrians.
3. Short distances from the main intersections to the U-turn crossovers may require RCUT intersections with multiple lanes on the minor street approach or in the U-turn crossover. Short distances may result in uneven lane utilization, as drivers preposition themselves for the next maneuver downstream. Uneven lane utilization reduces capacity.
4. An offset between the two minor streets at a four-approach RCUT intersection will reduce the pedestrian walking distance. This shorter distance would lead to shorter minimum green times for the minor street and major street left-turn signal phase.

The orientation of a RCUT intersection angle may influence the conversion of a conventional intersection to a RCUT intersection, as well as traffic operations. A RCUT intersection with less than 90 degrees (acute angle) can serve the left turns on the major street more efficiently than one greater than 90 degrees (obtuse angle). Exhibit 7-9 illustrates the intersection angles for a RCUT intersection.

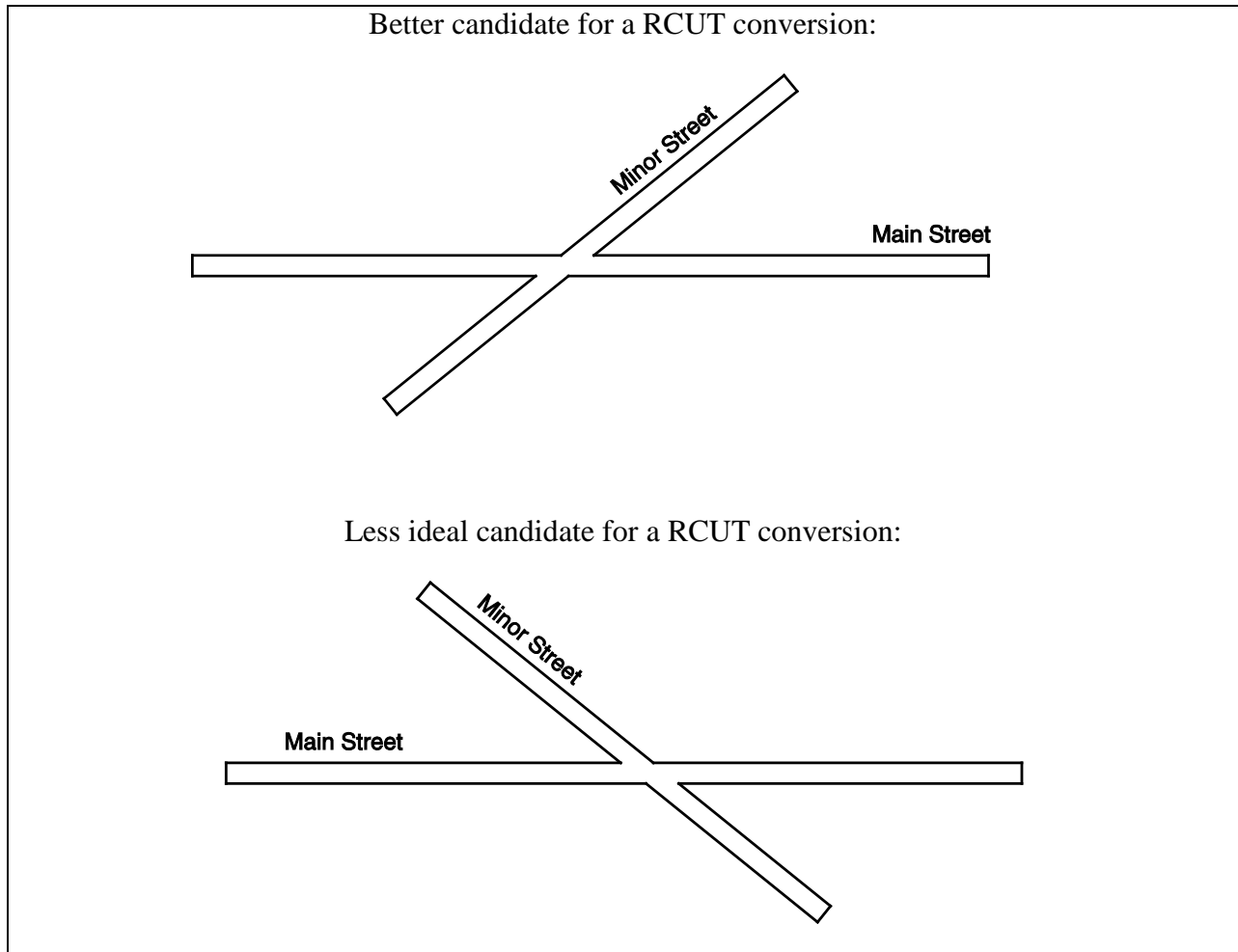

Exhibit 7-9. RCUT intersection angle considerations.

DESIGN GUIDANCE

This section provides design guidance for all types of RCUT intersections with stop signs, traffic signals, and merges. There is additional specific guidance related to RCUT intersections with merges provided at the end of this section.

RCUT intersections may be used on divided streets or on undivided streets with special provisions for accommodating U-turns. Geometric design guidance is organized into the following sections:

- Main intersection turn lanes
- U-turn crossover with two-way crossovers, or single directional crossovers
- Median widths and loons
- Right-of-way requirements

- Design vehicle accommodations
- Spacing between the main intersection and U-turn crossovers
- Spacing between crossovers along a MUT corridor of intersections
- Pedestrians and bicycles
- Transit

Main intersection turn lanes

Left-Turn Crossovers

At a four-approach RCUT intersection, each left-turn crossover serves just one movement (a major street left turn), while each U-turn crossover serves two movements (minor street left turn and through movements). Therefore, it is possible that the left-turn crossovers can serve traffic efficiently with only one lane each while the U-turn crossovers have two lanes each.

Exhibit 7-10 shows a detail of RCUT intersection left-turn crossovers from NCDOT.

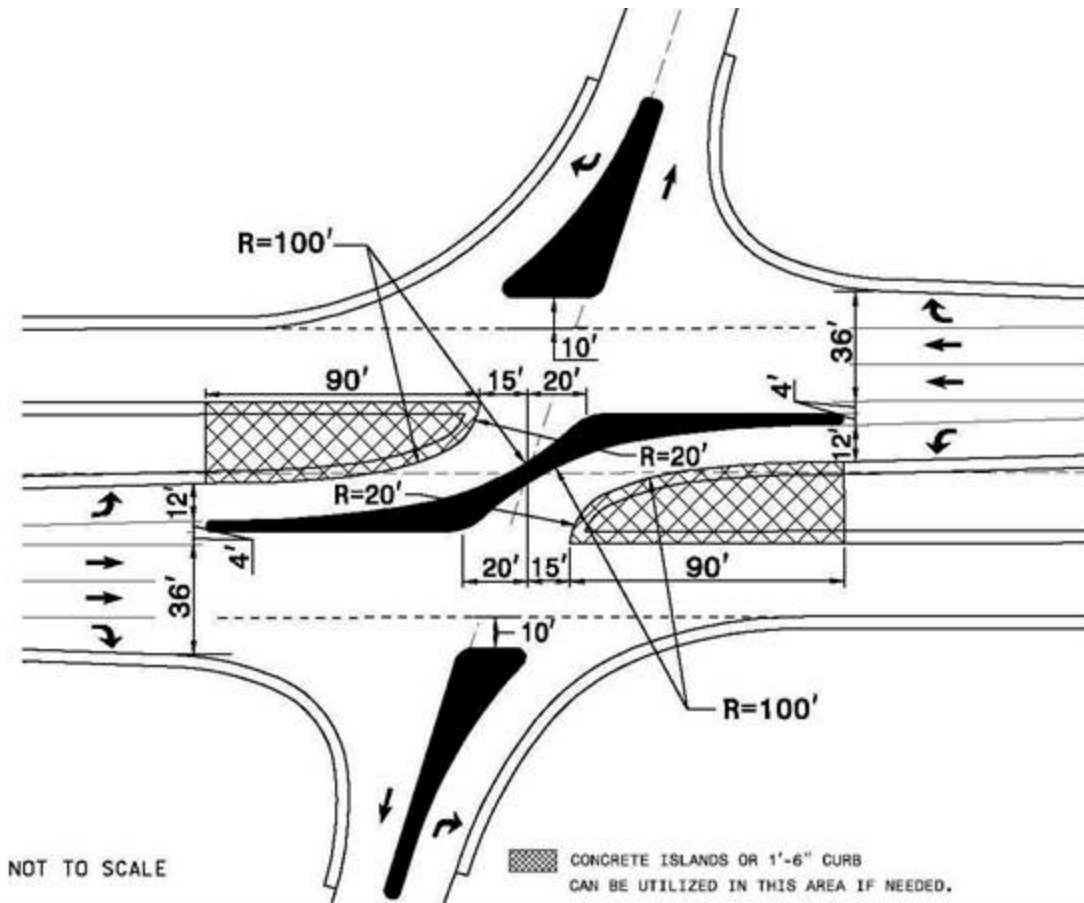

Exhibit 7-10. RCUT intersection schematic from NCDOT showing left-turn crossover dimensions.⁽³⁷⁾

The 100-foot radius curve fits within the 36-foot-wide median and allows sight lines for a left-turning vehicle to see past a queue in the opposing left-turn storage bay. A pedestrian refuge area should be provided in the middle of the channelizing island to allow for crosswalks or the future addition of crosswalks.

Drivers can violate the traffic control devices RCUT intersections in rural areas by making direct left turns from the minor street. Curbs on the median islands can discourage wrong-way movements. Aligning the minor street approach toward the intended turn direction, as shown in Exhibit 7-10, can encourage vehicles to turn right and discourage wrong-way movements. Typically, the design speed of the left-turn crossovers is 15 to 20 mph.

Direct Left Turn from Minor Street

If direct left turns from the major street are redirected to U-turn crossovers, direct left turns from the minor street can be allowed. Exhibit 7-11 shows an example of a minor street left-turn crossover on a street in Michigan. At this site, the left-turn crossover ends with a left merge into the major street. Other options for direct left turns from the minor street have been published but not constructed.⁽³⁸⁾



Exhibit 7-11. Minor street left turn crossover with a merge on Woodward Avenue in Birmingham, MI.⁽²⁾

Minor Street Approaches and Channelization

In most cases, the minor street approach to a RCUT intersection will have a median dividing the two directions of travel. As with any street or channelization separating oncoming movements, medians on the minor street help drivers to avoid head-on conflicts and discourage wrong-way maneuvers. Minor street medians should be a minimum of 6 feet wide. Three options exist for channelizing minor street traffic:

- No channelizing island

- A channelizing island (or channelizing end treatment on a median) separating all of the right-turn lanes from the minor street lanes leaving the intersection
- A channelizing island separating minor street right turns that remain on the major street from minor street right turns that subsequently make a U-turn on the major street (i.e. the redirected movements).

The advantages and disadvantages of right-turn channelization on the minor street at a RCUT intersection are described below:

1. Advantages

- Guides drivers more firmly, likely reducing sideswipe conflicts during the turn
- Shortens pedestrian crossing distances to a refuge
- Reduces the paved surface area
- Provides the opportunity for a lane addition and a free right turn (merge), reducing delay for that maneuver

2. Disadvantages

- Requires pedestrians to cross more vehicle pathways, with the right turns moving faster and/or freely; uncontrolled right turns are more difficult to navigate for visually-impaired pedestrians
- Creates potential for uneven lane utilization on the minor street
- Requires drivers on the minor street to select a lane earlier
- Increases right-of-way to accommodate the channelization

There are multiple ways to treat the RCUT intersection's minor street approach depending upon the storage bay length to the U-turn crossover. One option is to align the curve leading out of the minor street to continue directly into the storage bay for the U-turn crossover. The other option is to align it to the major street through lanes, with the U-turn crossover storage bay taper beginning further downstream. If the U-turn crossover storage bay needs to extend all the way back to the minor street, the first option aligning the turn directly into the bay for minor street vehicles is preferred.

The RCUT intersection example in Michigan (shown in Exhibit 7-7) shows both options, with the continuous curve into the storage bay on the left side of the photo (serving the southbound minor street if north is at the top of the photo) and the curve into the major street with the storage bay taper beginning downstream on the right side of the photo (serving northbound minor street traffic).

The example from North Carolina (shown in Exhibit 7-4) has the minor street vehicles turning into the major street lanes, while the example from Ohio (shown in Exhibit 7-6) shows minor street vehicles destined for the U-turn crossover turning directly into storage lanes.

Exhibit 7-12 shows a schematic example at a signalized RCUT intersection with one of the two minor street lanes leading directly into the storage bay for the U-turn. Exhibit 7-13 shows a schematic example of a signalized RCUT intersection with two of the three minor streets lanes leading directly into the storage bay for the U-turn; in this case, a channelizing island separates the two lanes leading into the storage bay from the third U-turn. The trade-offs of channelizing islands are noted above.

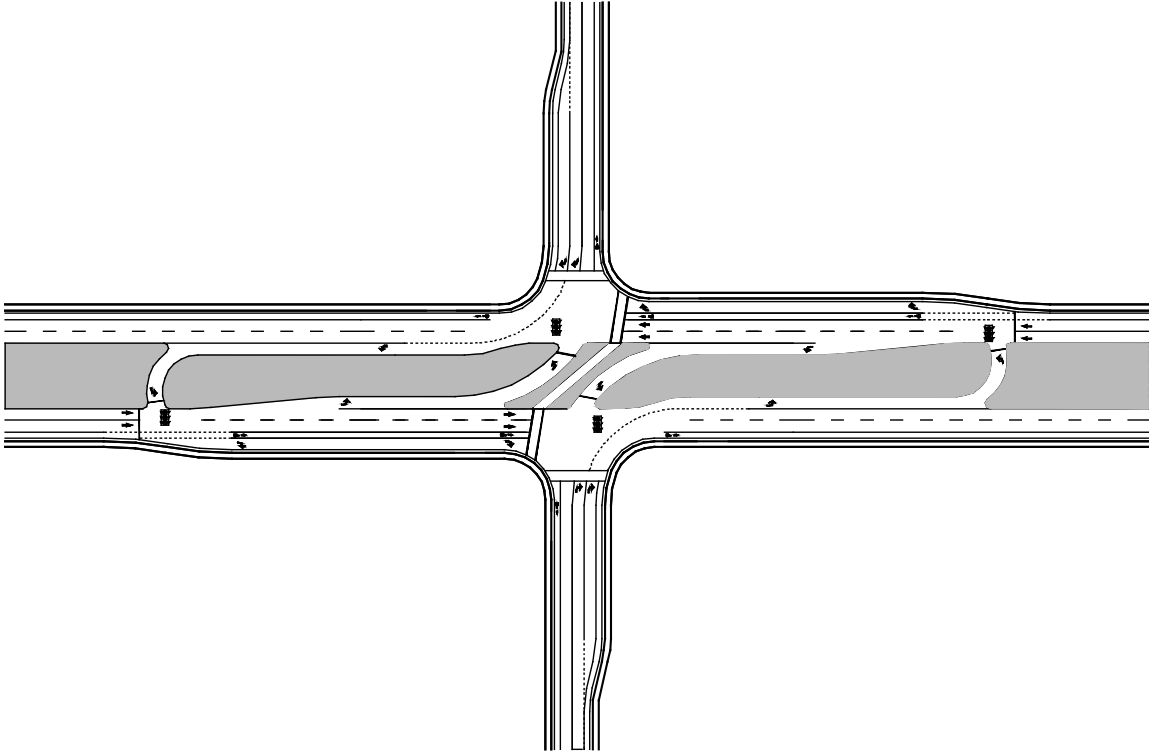

Exhibit 7-12. Schematic of RCUT intersection with one-lane, minor street approaches.

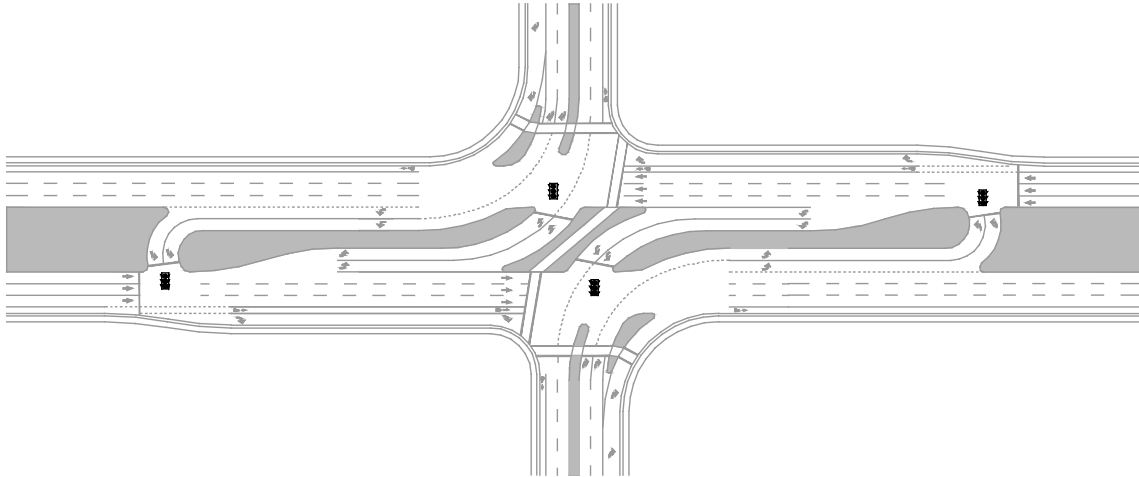

Exhibit 7-13. Signalized RCUT intersection with multiple lanes and channelization on the minor street.

U-turn crossover with two-way crossovers, or single directional crossovers

The U-turn crossovers at a RCUT intersection are quite similar to those at a MUT intersection. Therefore, for additional information, designers may consider referencing the Median U-turn Informational Guide.

The typical distance from the main intersection to the U-turn crossover at a RCUT intersection with stop signs or signals is 400 to 800 feet. In general, shorter travel distances result in fewer distance-related crashes such as animal and run-off-road crashes. Smaller distances also result in shorter travel times for minor street left-turn and through vehicles; this can be especially helpful to minor street bicyclists making a left turn or a through movement. A longer distance results in more time for drivers to understand navigational tasks and make corresponding decisions. The distance to the U-turn crossover is dictated by the need to provide a storage bay that avoids queue spillback.

The minimum distance between consecutive U-turn crossovers is dictated by the need for drivers at one stop bar to see past a queue built up in the storage bay of the other crossover. MDOT calls for a minimum separation of 100 feet and a desirable separation of 150 feet. If consecutive U-turn crossovers must be closer together, the crossovers may be signalized. In these cases, LTOR would be prohibited. The presence of pedestrians can influence the distance between consecutive U-turn crossovers. If pedestrian crosswalks are present at the crossovers, as mentioned in Chapter 3, a longer separation requires the sidewalk between the two crosswalks to run parallel to the major street for some distance; this is shown in Exhibit 7-17. The longer pedestrian distance increases the pedestrian travel time and could encourage jaywalking. The design speed for the U-turn crossovers is typically 15 mph.

Access Management Considerations

RCUT intersections do not require frontage roads to serve nearby land parcels. Driveways and side streets can be placed along a RCUT intersection at almost any point, generally avoiding the signal and near the entrance to a U-turn crossover as shown in Exhibit 7-14. Back-to-back crossovers with no access points between are shown in Exhibit 7-15.

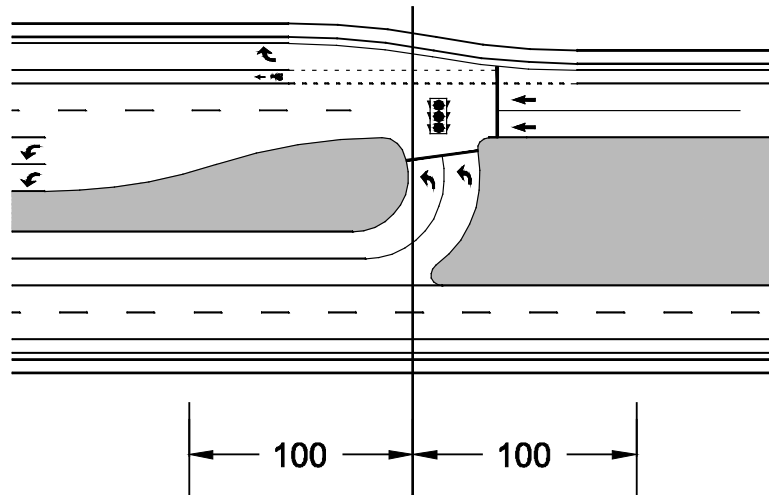

**Generally avoid access points
for 100 feet on either side of the
entrance to a U-turn crossover.**

Exhibit 7-14. Area near U-turn crossover where access point should be avoided.

This access-controlled area addresses the following items:

1. Discourages drivers from using that access point to enter the U-turn crossover
2. Discourages drivers from using that access point to drive the wrong way on the major street
3. Reduces the risk of blocking major street travel lanes while queued

Since there is no particular need to concentrate driveway and side street movements at a small number of points along the arterial, frontage roads typically provide little value for the cost and the right-of-way needed.



Exhibit 7-15. Back-to-back crossovers on Big Beaver Road in Troy, MI.⁽²⁾

Median widths and loons

An important consideration in the U-turn crossover design is accommodating the designated design vehicle. Providing a semi-circle of additional pavement outside the travel lane to allow the design vehicle to complete the U-turn maneuver and merge back into the traffic stream is called a “loon” or a “bump out.”⁽³⁹⁾ Exhibit 7-16 is a photograph of a loon implemented in Wilmington, NC. Exhibit 7-1 also shows a pavement marking channelizing the two lanes of the U-turn crossover, attempting to minimize sideswipe conflicts during side-by-side turns. Such pavement markings have been used at the RCUT intersections on US-281 in San Antonio, TX. Loons may be designed by applying a turning vehicle template for the chosen design vehicle. Signing to prohibit parking and additional enforcement may be necessary to keep loons free of stopped vehicles. U-turn crossovers may be located where there is available right-of-way for a loon.



Exhibit 7-16 Loon implemented on RCUT intersection in Wilmington, NC.⁽³⁾

Short of designing a full loon, there are other ways to accommodate U-turns by the chosen design vehicle at a RCUT intersection. One method of reducing right-of-way is to allow vehicles to turn onto the existing or widened shoulder. If the volume of trucks is relatively low, this can be a cost-effective approach, as strengthening the shoulder in the U-turn area may reduce long-term maintenance needs. The U-turn crossover on the right side of Exhibit 7-17 shows this configuration as implemented in Michigan. A second method is to design the U-turn to align into a right-turn lane, as illustrated by the U-turn crossover on the left side of Exhibit 7-17.



Exhibit 7-17. Other treatments used at U-turn crossovers on Twelve Mile Road in Farmington Hills, MI to accommodate large vehicles.⁽²⁾

The AASHTO Green Book provides values for minimum median width without loons based on the needs of U-turning design vehicles, as shown in Exhibit 7-18. Without a loon or other treatment, the design vehicle and the number of opposing lanes directly govern the needed median width at the crossover.⁽⁵⁾ A median width of 69 feet is needed to serve aWB-67 U-turn maneuver without encroaching on the outside curbs or shoulders of a four-lane major street. This directive reflects the value of 57 feet from Exhibit 7-18 plus 12 feet for the width of the storage lane leading into the U-turn crossover. Assuming 12-foot-wide lanes and right-of-way limits 10 feet beyond the edge of the travel way, the right-of-way for RCUT intersection major streets without loons can range from 137 feet for four-lane arterials to 161 feet for eight-lane arterials.

Restricted Crossing U-turn Informational Guide

		U.S. Customary						
		M—Minimum Width of Median (m) for Design Vehicle						
		P	WB-40	SU-30	BUS	SU-40	WB-62	WB-67
		Length of Design Vehicle (ft)						
Type of Maneuver		19	50	30	40	40	63	68
Inner Lane to Inner Lane		30	61	63	63	76	69	69
Inner Lane to Outer Lane		18	49	51	51	64	57	57
Inner Lane to Shoulder		8	39	41	41	54	47	47

Exhibit 7-18. AASHTO-recommended minimum median widths for U-turn crossovers.⁽⁵⁾

Placing the storage bays for the left-turn and U-turn crossovers back-to-back rather than side-to-side is a means of minimizing the median width in a RCUT intersection. Exhibit 7-19 shows a sketch of a RCUT with back-to-back two-lane storage bays. This results in a 30-foot-wide median. Back-to-back storage bays length and design are based on providing storage for the estimated queue lengths for the design period from the operation analysis (refer to Chapters 5 and 6 for more details).

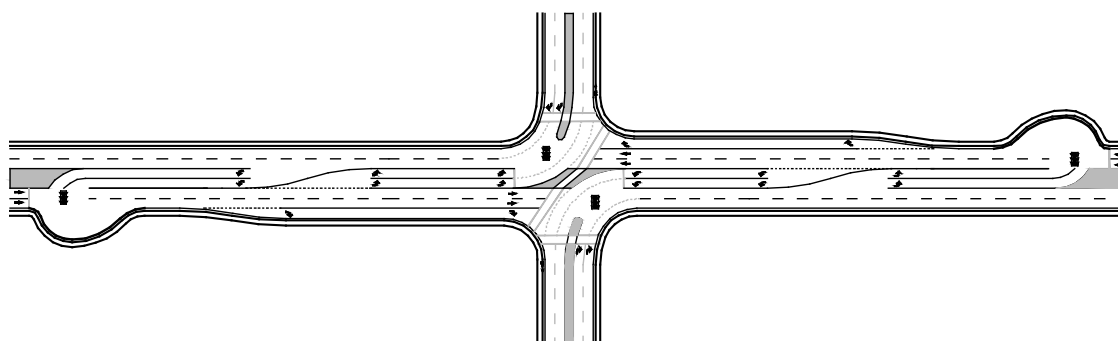

Exhibit 7-19. RCUT intersection with back-to-back two-lane crossover storage bays.

Restricted Crossing U-turn Informational Guide

Exhibit 7-20 and Exhibit 7-21 illustrate MDOT guidelines for designing directional median crossovers and show one-lane crossovers.⁽²⁸⁾ Large trucks and other heavy vehicles typically use the entire width of the crossover. MDOT uses striped two-lane crossovers (with two lanes of storage leading up to the crossover) in some places. If considering the application of striped two-lane crossovers, the designer should check the local and state agency standards to determine if this is allowed. These crossovers are typically 36 feet wide.

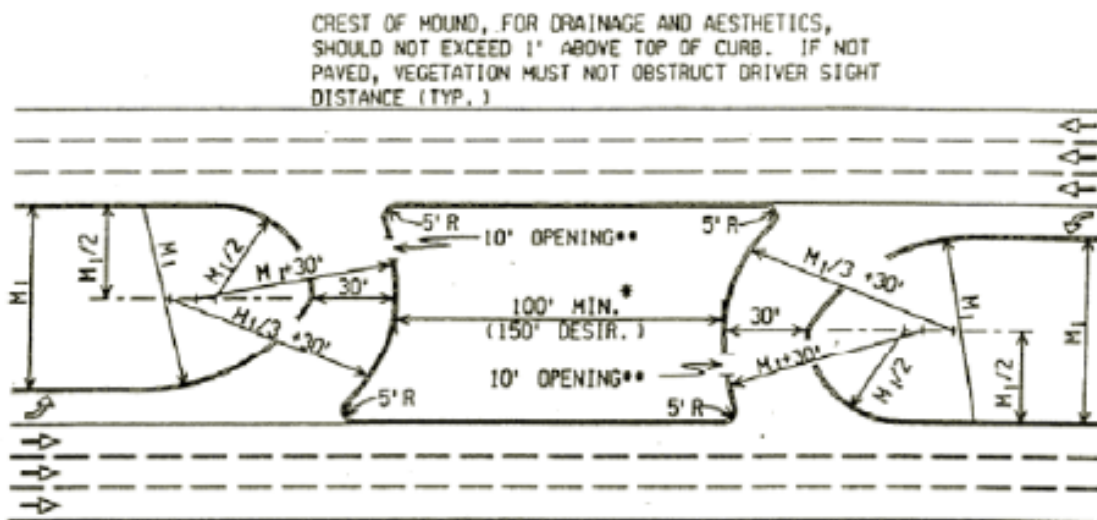

Exhibit 7-20. U-turn crossover design on highway with curbs.⁽²⁸⁾

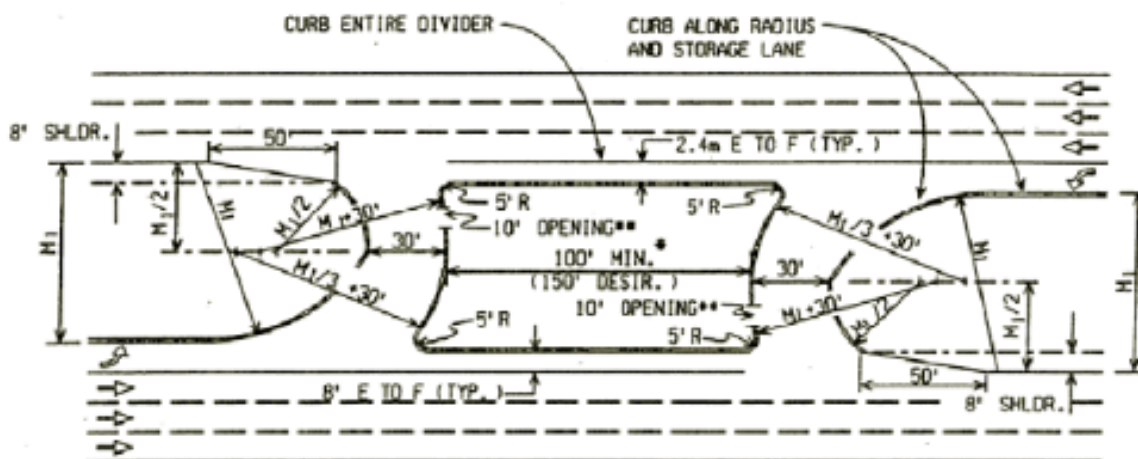

Exhibit 7-21. U-turn crossover design on highway without curbs.⁽²⁸⁾

A RCUT intersection can generally accommodate access to nearby parcels. Access points are generally avoided near a signal or near the entrance to a U-turn crossover (as shown earlier in Exhibit 7-4). Driveways or side streets may be aligned with the exit of a U-turn crossover. MDOT has extensive experience with this practice along MUT corridors and has revealed no safety or operational concerns. If there is a significant traffic demand by right-turning vehicles coming out of the driveway or side-street, adding a third signal phase can manage the conflict between the right-turning vehicles and U-turning vehicles. This has been added at a U-turn

crossover on Eight Mile Road in Detroit, MI just east of Woodward Avenue. In most cases, motorists manage that conflict adequately as shown by the safety record of the MUT arterials in Michigan as described in the Median U-turn Informational Guide.

Right-of-way requirements

The median width of a RCUT intersection is the main variable in determining the necessary major street right-of-way width. If loons are used at the U-turn crossovers, the median may be as narrow as a left-turn lane and a minimal median separation (i.e. a 12-foot lane and a 6-foot median). As presented previously, a 69-foot-wide median will typically allow U-turns by large trucks or buses on a four-lane major street without encroaching over the curb or needing to include a loon.

Based on the median width requirements described above, MDOT uses median widths between 47 and 71 feet to accommodate design vehicles at U-turn crossovers at MUT intersections without encroaching on outside curbs or shoulders. These dimensions are also applicable to RCUT intersections. If 12-foot lanes are assumed and an additional 10 feet is provided beyond the edge of the travelled street for drainage and utilities, the right-of-way can vary from 139 feet for four-lane streets to 163 feet for eight-lane streets. Similarly, using Exhibit 7-19 for minimum median widths, when designing U-turns and using the same lane width assumptions described above, the right-of-way requirements would range from 139 feet for four-lane streets and 165 feet for eight-lane streets.

Design vehicle accommodations

Crossovers at a RCUT intersection are only used by vehicles heading to or from the minor street (or an access point along the main street). Therefore, the design vehicle for the crossovers can usually be the same as the design vehicle for the minor street or access point. The design vehicle is usually a tractor-trailer configuration but could be a bus or emergency response vehicle. In an urban area, the design vehicle at a RCUT intersection need be no larger than what can be served on the surrounding street network.

The design vehicle's turning movements at the U-turn crossover and the additional time required for design vehicles to complete this movement are the primary differences between the design of a conventional intersection and a RCUT intersection. Where loons are not used, the medians typically need to be 47 to 71 feet wide to accommodate the turning radius and the width of a design vehicle's turning path; for comparison, medians at conventional intersections with dual-left turn lanes are typically 28 feet. Additionally, the lane width of the crossover must be increased to accommodate the turning path of the larger vehicles.

Dual U-turn lanes can be implemented if vehicle demand supports it. Dual-lane U-turns are often designed so that a large truck's swept path would use both lanes, as discussed in Chapter 4 and shown in Exhibit 4-10. If a high percentage or number of heavy vehicles is anticipated, dual U-turn lanes can be designed to accommodate large trucks and buses in both lanes side by side, simultaneously. The size of the U-turn crossover could be reduced if large vehicles were limited to one lane by signing and regulation, eliminating the possibility of two large vehicles using the crossover at the same time.

Additional signal time must also be provided for heavy vehicles at the U-turn crossover. Studies have shown that U-turns require up to 17-percent more time for passenger cars to complete than a right- or left-turn movement.⁽²⁸⁾ Therefore, it is expected that heavy vehicles may require even more time to complete U-turns than passenger cars.

Spacing between the main intersection and U-turn crossovers

The distance between the main intersection and the U-turn crossover must be considered for both directions of travel on the major crossroad. The distance for right-turning vehicles (with a destination to the minor street or left on the major street) from the minor crossroad to move from the right side of the major crossroad after completing their right turn to the left side prior to the deceleration lane. While traffic laws vary among states, in some states, right-turning vehicles are mandated to enter the rightmost lane available on the crossroad into which they are turning. This distance is shown in Exhibit 7-22.

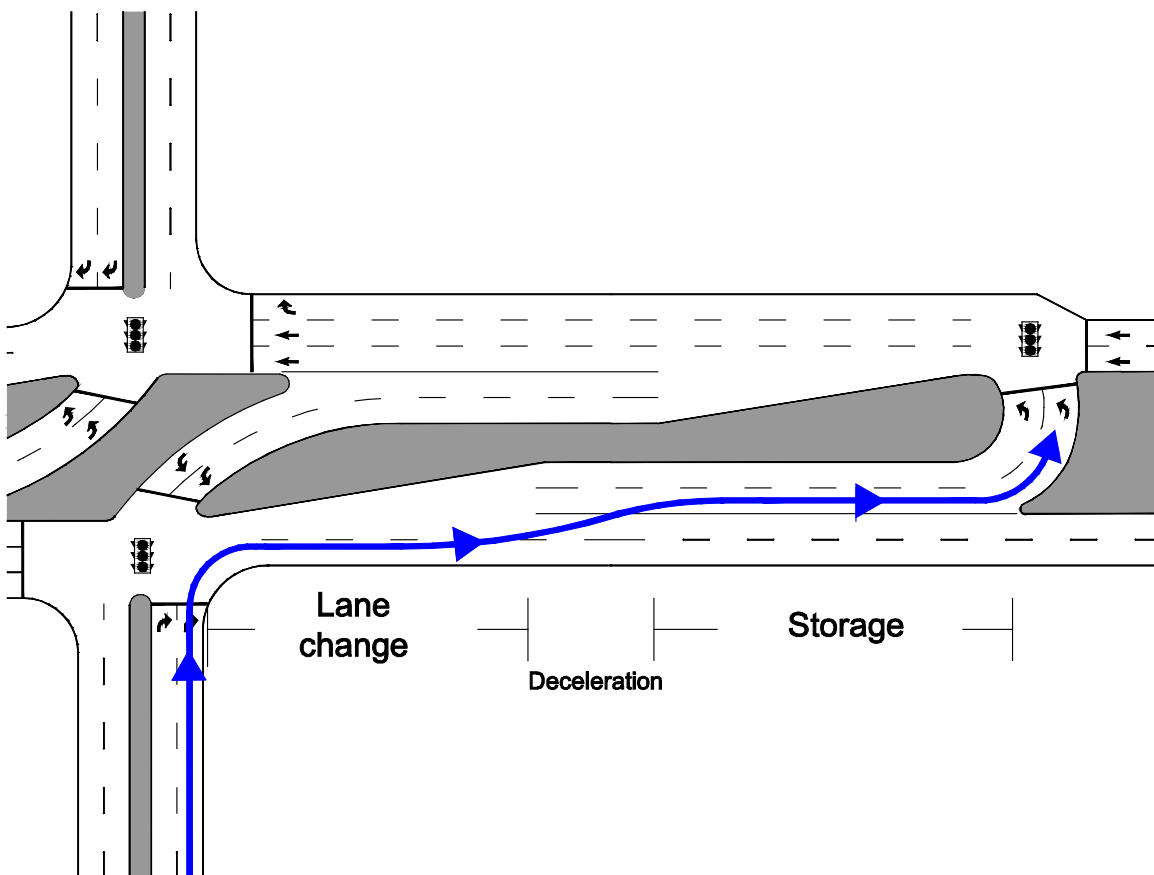

Exhibit 7-22. Spacing consideration for a minor street through or left movement.

The AASHTO Green Book and MDOT provide guidance on the distance between the main intersection and a U-turn crossover at a RCUT intersection.

MDOT recommends a distance of 660 feet \pm 100 feet between the main intersection and the U-turn crossover for a RCUT intersection, which is based in part on the deceleration length required for the major street having a posted speed limit of 45 mph.⁽²⁶⁾ The AASHTO Green Book recommends a distance range of 400 to 600 feet.⁽⁵⁾ The AASHTO Green Book also suggests that at locations where the U-turn crossovers were designed specifically for eliminating direct left turns at a major intersection, the crossover should be located downstream of the intersection, preferably mid-block between adjacent crossroad intersections.

Where the minimum required distance to the U-turn crossover plus the distance required for the next downstream left-turn lane are greater than the distance between the two adjacent intersections, the AASHTO Green Book recommends the U-turn crossover should be located 50 to 100 feet in advance on the next downstream left-turn lane.⁽⁵⁾

Spacing between crossovers along a RCUT corridor of intersections

On a corridor with multiple RCUT intersections, the spacing between opposing directional U-turn crossovers should be sufficient to prevent operational conflicts between the two U-turn crossovers. MDOT guidance for MUT corridors suggests a 100 feet minimum and 150 feet desirable distance; this is also applicable to RCUT intersections.

Pedestrians and bicycles

Chapter 3 provides guidelines to accommodate pedestrians and bicyclists at RCUT intersections. As for conventional intersection design, ADA and PROWAG guidelines provide guidance for designing crosswalks, pedestrian ramps, and sidewalks, which applies to both pedestrian and shared-use pedestrian/bicycle paths.⁽²⁰⁾

As discussed in Chapter 3, the “Z” crossing shown in Exhibit 3-1 is the most common design at this time at existing RCUT intersections.

Transit

As discussed in Chapter 3, transit bus stops are located similarly to a conventional intersection.

Additional Guidance for RCUT Intersections with Merges

Examples of RCUT intersections constructed in Maryland are shown in Exhibit 7-5. RCUT intersections with merges have one-lane minor street approaches and one-lane crossovers. The distance from the minor street to the U-turn crossover from the main intersection (typically 2,000 to 2,600 feet) is longer than for other types of RCUT intersections. Auxiliary lanes can be used to support higher major street speeds. The AASHTO Green Book provides guidance on determining auxiliary lane lengths for each condition.⁽⁵⁾ Exhibit 7-5 shows an acceleration lane for U-turning drivers that was constructed into the median and then continued as an auxiliary lane to the left-turn crossover.⁽³⁾

The components of the street between the minor street to the U-turn crossover are an acceleration lane plus taper, a certain weaving length for vehicles to move from the right to the left side of the major street, and a taper plus deceleration lane on the left side.⁽³⁾ The components of the street

between the U-turn crossover and the minor street are a left-side acceleration lane plus taper, a certain weaving length for vehicles to merge from the left to the right side (for the minor street through vehicles), and a taper plus deceleration lane. Designers should determine the desired length in both directions and then use the larger of the two values. The AASHTO Green Book provides guidance on determining acceleration and deceleration lane length and taper length. Criteria for a minimum weaving length for this scenario do not exist.⁽⁵⁾

If the U-turn crossover ends in a left-side merge with the major street, the median on the major street will have to be wider than at other types of RCUT intersections or the U-turn will not be able to accommodate large vehicles. For the example from Maryland shown in Figure 7-5, the median is about 50 feet wide and the U-turn crossover likely can accommodate vehicles no larger than passenger cars without encroachment into the major street travel lanes. Larger U-turning vehicles likely have to yield in the crossover and wait for a gap in the major street traffic stream. Exhibit 7-18, showing needed median widths to accommodate various U-turning design vehicles, will be helpful to find the optimum median width.

CHAPTER 8--SIGNALS, SIGNING, MARKING, AND LIGHTING

Traffic control devices are critical elements at all intersections. Their role is especially vital to the success of alternative designs like the RCUT intersection. As users may be unfamiliar with this type of alternative intersection, adequate traffic control devices are necessary to promote its intended use. Since the opportunity to create progression is a key feature and benefit of the RCUT intersection, signal design is central to the success of a signalized RCUT intersection.

This chapter describes current practices for signalizing, signing, marking, and lighting a RCUT intersection. The chapter supplements the available national resources on traffic control devices at intersections, including the MUTCD and local agency design standards and policies.⁽⁷⁾ Agencies building their first RCUT intersection may benefit from considering traffic control devices generated by other agencies that have successfully implemented RCUT intersections. This chapter focuses on traffic control devices and is complementary to Chapters 5 and 6, which described the operational characteristics of RCUT intersections and showed how to conduct an operational analysis of a RCUT intersection, respectively.

DESIGN PRINCIPLES AND APPROACH

Traffic signal design, signing, pavement marking, and lighting design at a RCUT intersection can be different from conventional intersections, particularly in relation to the minor street movement prohibitions at the main intersection. The following treatments are unique at RCUT intersections compared to conventional forms:

- Provide signage and pavement markings to indicate the prohibition of through and left turns on the minor street and alternative routing of these movements
- Provide one-way and wrong-way signage to supplement the channelization of U-turn intersections
- Provide a means for safe and convenient pedestrian and bicycle crossings
- Provide appropriate lighting at conflict points (i.e., main and U-turn intersections) within the RCUT configuration to emphasize the presence of various users

SIGNALIZED VERSUS UNSIGNALIZED RCUT INTERSECTIONS

As noted throughout this Guide, RCUT intersections may be signalized or unsignalized with stop signs, yield signs, or merges at the minor streets and crossovers. Unsignalized RCUT intersections can provide adequate operations if the traffic demands are low. If the minor street ADT is 5,000 or more, a RCUT intersection will generally operate better with signals.

Many tools are available to evaluate an unsignalized or signalized RCUT intersection. Chapter 6 notes how planning analyses, capacity and level of service analyses, various macroscopic analysis software packages, and various microscopic analysis software packages can be used to evaluate RCUT operations. The MUTCD signal warrants apply to RCUT and other intersections.

SIGNALS

A RCUT intersection can provide bi-directional progression (further discussed in Chapter 5) with each direction of the arterial coordinated independently at various speeds and signal spacings, similar to a pair of one-way streets. While adding extra cost compared to a conventional intersection with one signal, the additional signals at a RCUT intersection do not degrade traffic operations.

A four-legged RCUT intersection may have between one and four traffic signals, or up to six signals if signalized pedestrian crosswalks at the U-turn crossovers are included. If one signal at a RCUT intersection is warranted, as a rule of thumb, it is likely all four will be. U-turn crossovers typically serve a large fraction of the demand at the minor street. Generally, if a signal is justified at the main intersection, it will likely also be appropriate at the accompanying U-turn crossover.

Controllers

Different traffic signalization practices may affect the number of signal controllers provided at a RCUT intersection.

For a four-legged RCUT intersection with four typical signal locations, separate signal controllers can be installed at each of the four signal locations. This preserves the independence of the signal control on either side of the arterial. This practice may increase the implementation cost of RCUT intersection installation and may prevent the signals from working together optimally in an actuated environment. Exhibit 8-1 illustrates a RCUT intersection with four separate controllers.

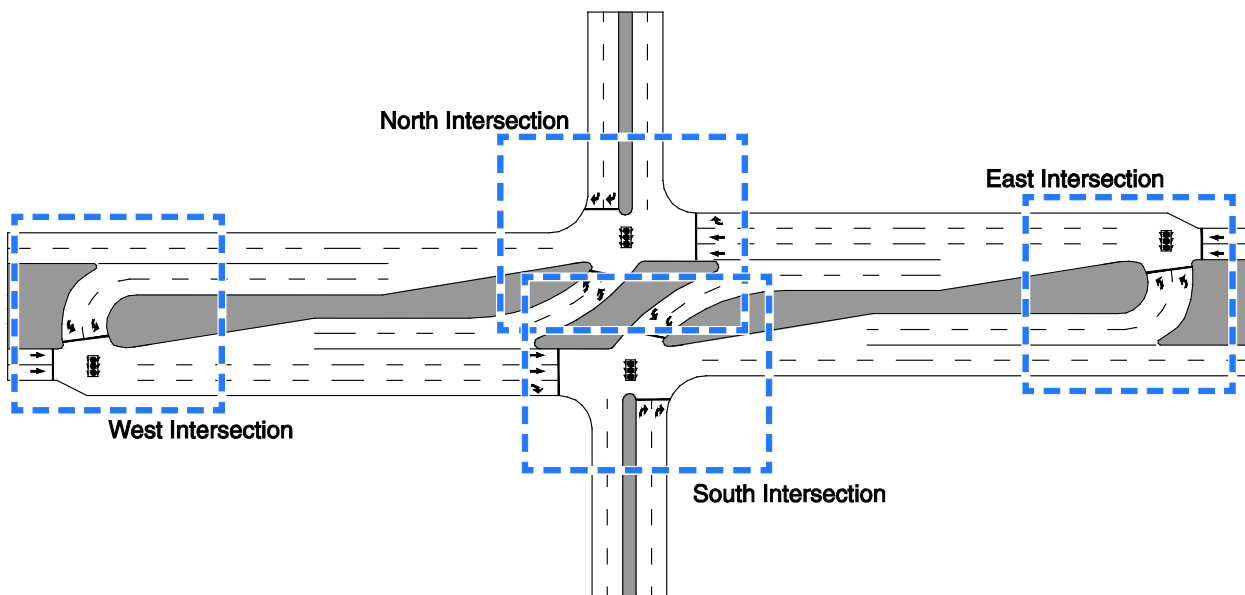

Exhibit 8-1. RCUT intersection with four separate controllers.

RCUT intersections may feature three controllers. One controller would handle the signal displays at the main intersection, and the other controllers would handle the signal displays at the U-turn crossovers. This design would not allow different cycle lengths in each direction of the arterial. Exhibit 8-2 illustrates a RCUT intersection with three separate controllers.

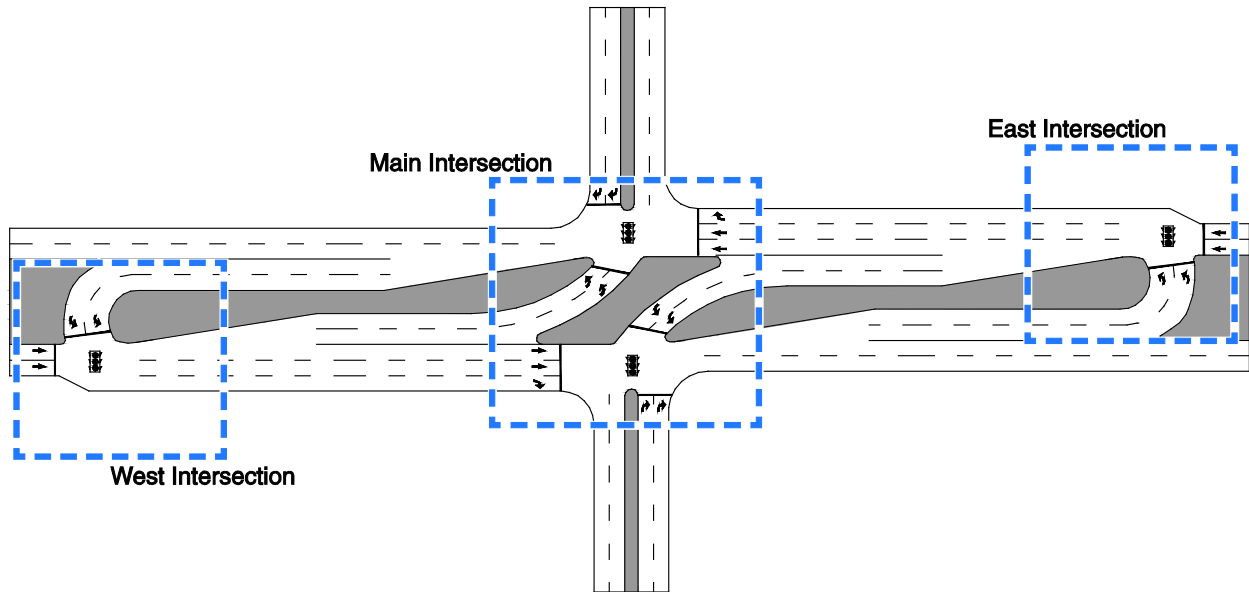

Exhibit 8-2. RCUT intersection with three separate controllers.

It is possible for a RCUT configuration to use two controllers; with each controlling the signals for each direction of the arterial. This design would allow different cycle lengths in each direction of the major street. Exhibit 8-3 illustrates a RCUT intersection with two separate controllers.

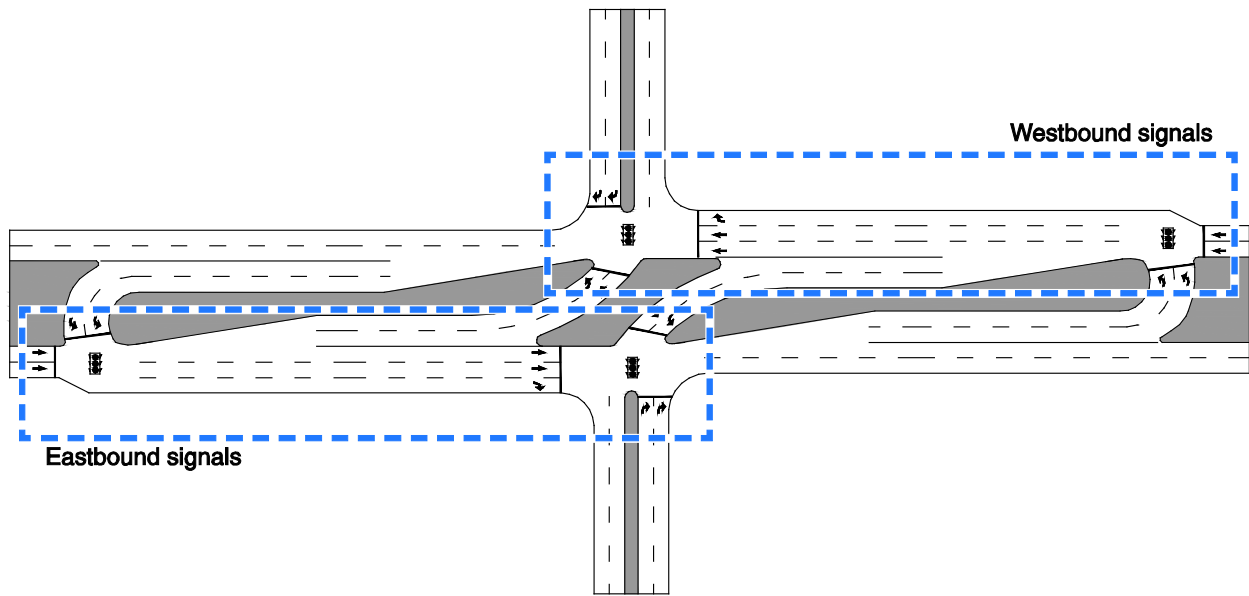

Exhibit 8-3. RCUT intersection with two separate controllers.

Finally, a RCUT intersection can be signalized with one controller as described earlier in this chapter. One controller would be less expensive but would result in fewer control options and no chance to have different cycle lengths in each direction of the major street. Exhibit 8-4 illustrates a RCUT intersection with a single controller.

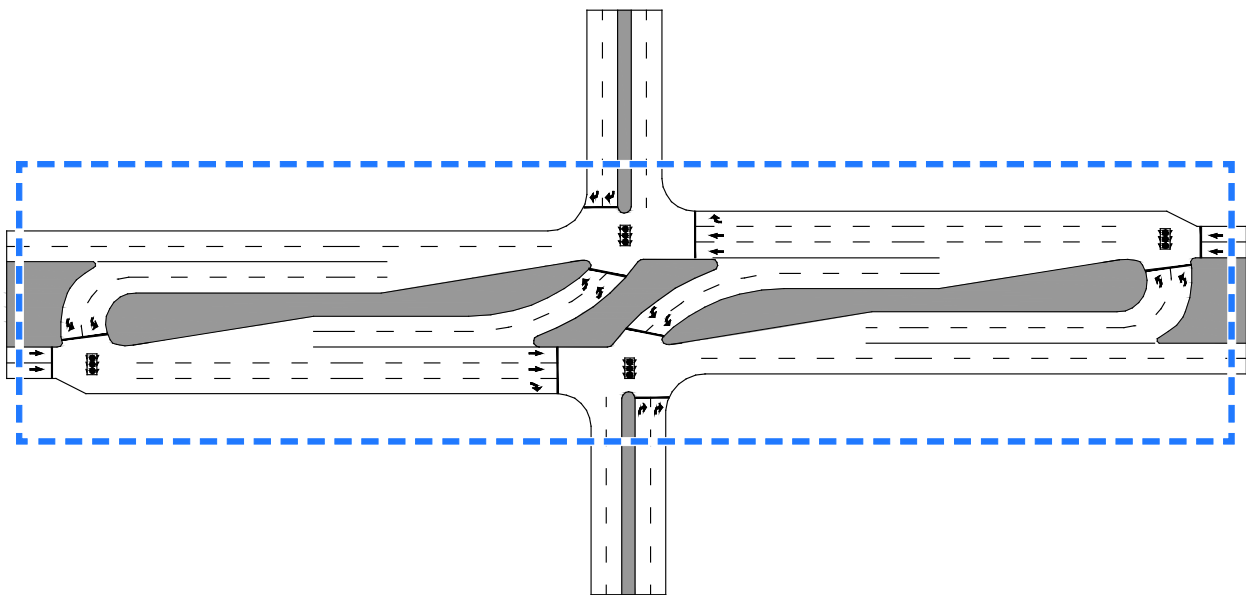

Exhibit 8-4. RCUT intersection with a single controller.

The advantages of single- and multiple-controller signal systems are described below.

Advantages of multiple controllers instead of a single controller include:

- Independent, bi-directional coordination is easier to operate
- If one controller fails, the other intersections of the RCUT can still function
- Programming phases and signal timing are simpler to install and maintain
- Installations require shorter wire lengths (signal conductor wire/detector wire runs to local controller only)
- Easier for signal maintenance in that each cabinet will likely be placed with visibility provided to the signal heads it controls

Advantages of a single controller instead of multiple controllers include:

- The system requires fewer cabinets and controllers to purchase, install, and maintain
- Interconnection is not required to keep signals coordinated
- There is a single controller to program and maintain
- There is a single service point for power
- There are fewer components to fail
- Vehicle detection may be easier to configure

Signal Equipment Locations

Mast arms and signal head locations should result in signals that are highly visible to the applicable traffic stream, especially to traffic using the crossovers. The placement should not be confusing to drivers. As with any signalized intersection, traffic equipment must be located to minimize crash potential. Traffic equipment placement should consider pedestrian and bicycle travel areas and not be an obstacle or inadvertently screen these users from the street. Exhibit 8-5 shows pole, mast arm, and head locations for a typical signalized RCUT intersection constructed by NCDOT. The figure shows a pole-mounted signal head in the median for traffic using the U-turn crossover to supplement the overhead far-side heads. Some agencies in Michigan also use this configuration.

The presence of a loon creates special considerations when locating the signal pole and mast arm for a signal at the U-turn crossover.⁽³⁾ Exhibits 8-6 through 8-9 show signal installations along the RCUT corridor on US-17 in Brunswick County, NC. In Exhibit 8-8, note how a signal pole was placed at the loon, in contrast to Exhibit 8-5 where the pole is shown downstream of the loon. Exhibits 8-6, 8-7, and 8-9 also show US-17 RCUT intersections operating with pole-mounted signals in the median for the U-turning traffic. A potential disadvantage for signal

Restricted Crossing U-turn Informational Guide

heads mounted on poles in the median is that sight lines to these signal heads may be blocked by queued traffic.

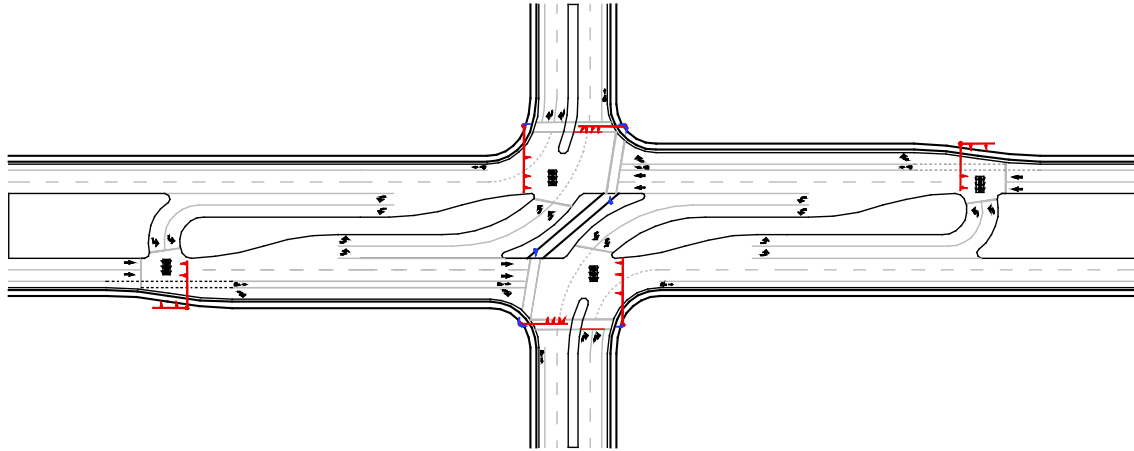

Exhibit 8-5. Possible signal pole and mast arm locations for RCUT intersection.



Exhibit 8-6. Signal pole locations at the main intersection of a RCUT intersection on US-17 in North Carolina.⁽³⁾

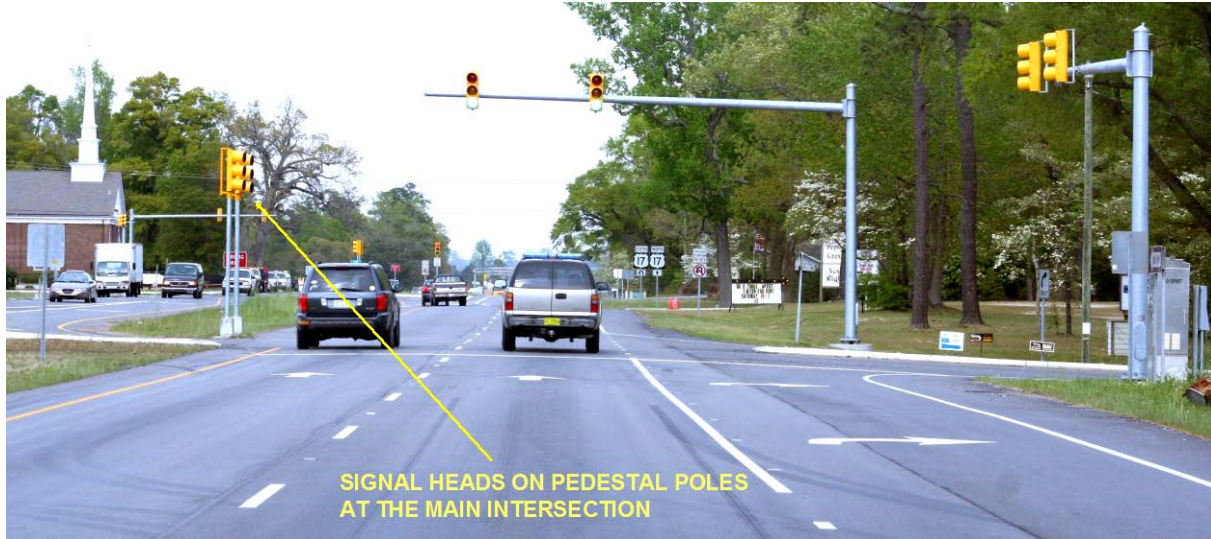

Exhibit 8-7. Signal pole locations at the main intersection of another RCUT intersection on US-17 in North Carolina.⁽³⁾



Exhibit 8-8. Signal pole locations at the U-turn crossover of a RCUT intersection on US-17 in North Carolina.⁽³⁾



Exhibit 8-9. Signal pole locations on the minor street approaches of a RCUT intersection on US-17 in North Carolina.⁽³⁾

Detection

Exhibit 8-10 shows potential detector placements at a RCUT intersection. Vehicle, bicycle, and pedestrian detection can be implemented similar to a conventional intersection to “call-off” phases that have extra green time. This green time could be allocated to other phases needing additional green time. This technique may be simpler in a RCUT intersection since there are only two phases needing to be adjusted compared to a conventional intersection. This technique can be particularly effective in off-peak times by providing more green time to the displaced left turns, mitigating the longer travel path.

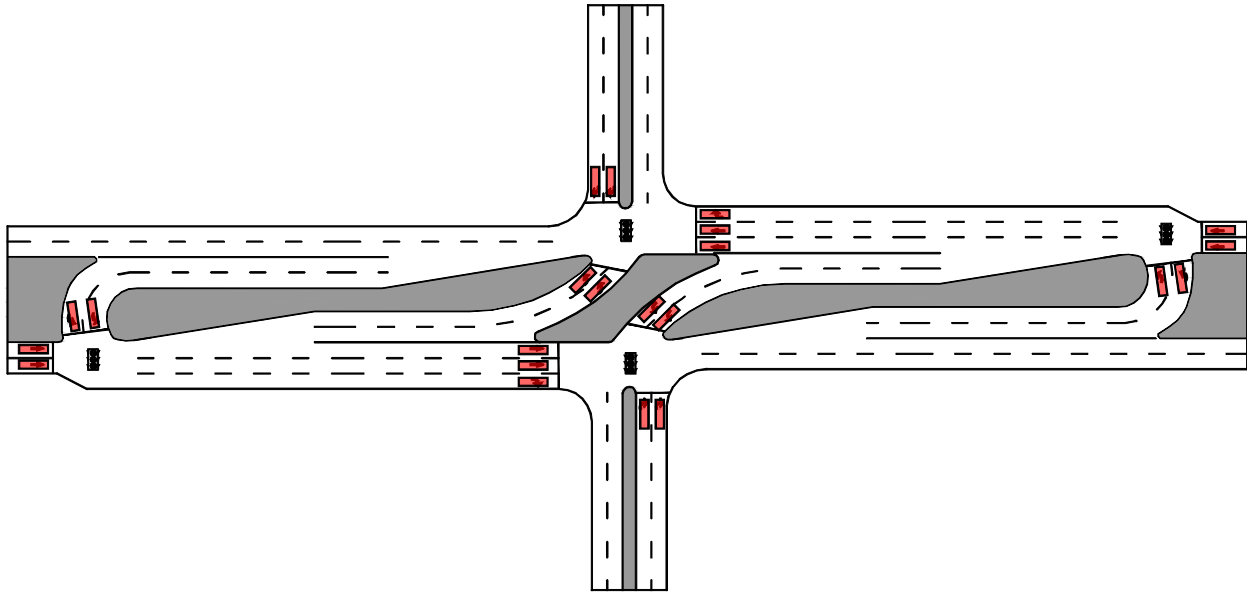

Exhibit 8-10. Potential detector placements.

Pedestrian Signals

Pedestrian signals at a RCUT intersection should be installed to accommodate a two-stage crossing, even if it is possible to make a single-stage crossing. This is because pedestrians who are slower or faster than the design value for walking speed may get caught in the median with a red signal. This means a set of pedestrian signal heads, push buttons, and accessible pedestrian signals would be provided in the median as well as on the roadside, as Exhibit 8-9 showed previously.

Bicycle Signals

In general, bicycle signals are used to direct and control bicycle movements that are atypical compared to conventional intersections and not concurrent with vehicle movements. Chapter 3 of this guide discusses a number of options for minor street through and left-turn movements by bicycles, some of which involve passing through the channelizing island in the center of the main intersection. Although there are no known installations to date, bicycle signals could be provided at a RCUT intersection for such movements.

SIGNING

Signing a RCUT intersection is similar to signing and marking a MUT intersection (as described in an accompanying guide) or other alternative intersection that reroutes left-turning movements. Special signing and marking considerations at a RCUT intersection compared to a conventional form include:

- Providing destination guide signing for the minor street left-turn and through movements

- Including signs to guide motorists to the optimum lane in a multilane minor street approach or in a multilane crossover
- Providing signing for right or left turn on red prohibitions

This section addresses signing and for signal-controlled RCUT intersections, stop-controlled RCUT intersections, and RCUT intersections with merges. Some of the signing and marking practices depicted in this section reflect observed practice at RCUT intersections that may not be included in the MUTCD.⁽⁷⁾ The MUTCD includes a procedure for agencies wishing to conduct field experiments with new signs and markings.

Signal-Controlled

Exhibit 8-11 shows a signing plan for one direction of travel at a signalized RCUT intersection based largely on Maryland State Highway Administration guidance. RCUT intersection signing is not explicitly addressed in the MUTCD.

The key elements are well-placed regulatory signs to indicate prohibited movements and clear and visible guide signs to aid the minor street left-turn and through traffic. In the plan shown in Exhibit 8-11 there is no sign or marking provided for U-turn crossover or minor street vehicles on which lane they should choose to reach a particular destination. However, such a sign was developed for a RCUT intersection in Texas. Whether to provide lane choice signing and marking is left to the agency's discretion and is discussed below. Standard street name signs at the main intersection may be helpful for main street motorists. Wide main streets could benefit from a guide sign in the median just beyond the main intersection and also on the right (shoulder) side of the street. Exhibit 8-12 shows two options for a sign in the median on the approach to a U-turn crossover.

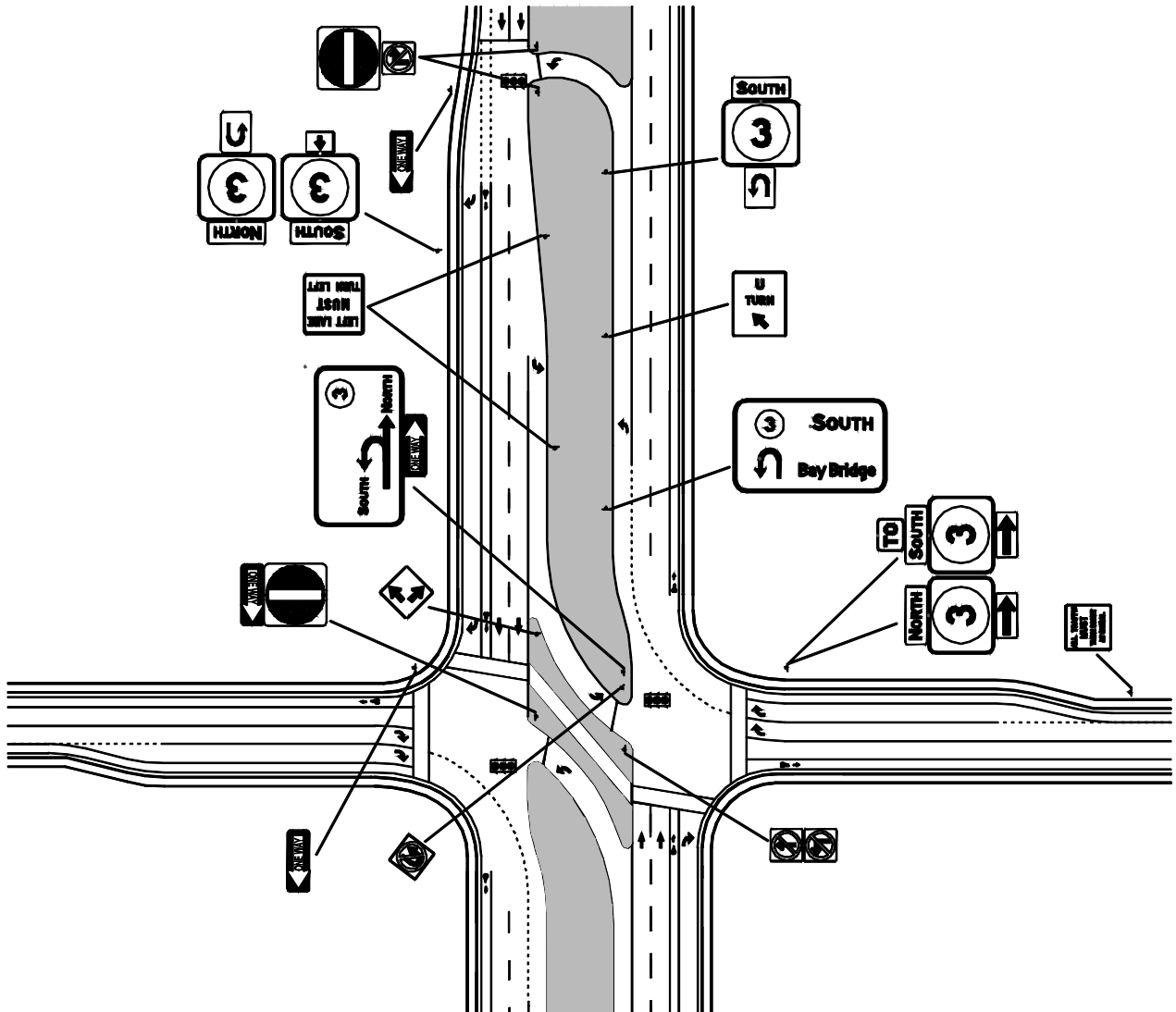

Exhibit 8-11. Signalized RCUT intersection signing plan derived from Maryland practice.⁽³⁾

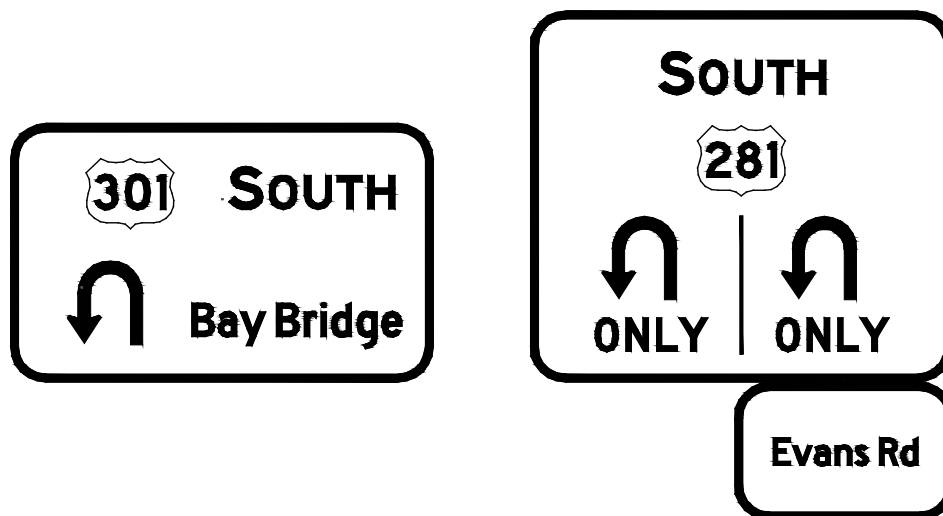

Exhibit 8-12. Guide signs for U-turn crossovers based on Maryland (left side) and Texas (right side) practice.

Allowing right turn on red (RTOR) and/or left turn on red (LTOR) (if allowed by law) at a RCUT intersection can reduce travel times. RTOR is generally easier for motorists to execute from a minor street at a RCUT intersection compared to a conventional intersection. This is because there is no legal crossing for pedestrians on that corner seeking to cross the main street. The LTOR movement from a U-turn crossover generally does not encounter pedestrian traffic. Prohibiting RTOR and/or LTOR is conveyed via regulatory signing. This can include multiple signs on any particular approach prohibiting RTOR or LTOR, especially on wide minor street approaches or multilane crossovers. Some agencies chose to post signs saying what is allowed. For example, Texas agencies have posted “TURN ON GREEN ARROW ONLY” regulatory signs on some of its U-turn crossovers. An agency in Michigan posts regulatory “PROCEED ON GREEN [ball] ONLY.”

In multilane U-turn crossovers on MUT corridors in Michigan, the inner lane is typically marked as a U-turn only lane while the outer lane is marked as an optional U-turn or straight through lane (if there is a driveway or side street at the end of the crossover). By contrast, at the RCUT intersections in Michigan and in North Carolina, the agencies provide no guidance to minor street or crossover traffic as far as which lane of a multilane approach or crossover drivers should use for a certain destination.

At a RCUT intersection where the minor street is busy, additional guidance to minor street through motorists on the median signs may be beneficial. Examples in Texas have included overhead lane use signing to guide minor street motorists into the desired lane. Exhibit 8-13 shows the overhead lane use signs on the three-lane minor street approach (Evans Road) to US-281. The sign is placed about 350 feet prior to the stop bar. The middle lane can be used by drivers making the minor street through movement (following Evans Road) or making the minor street right-turn movement onto northbound US-281. The other two lanes of the approach serve specific destinations. Exhibit 8-14, with an overhead view of the RCUT intersection, shows a traffic island to separate the right lane of the minor street approach from the others. This example

also has dotted lane extension pavement markings to guide turning into the appropriate receiving lane. Specific lane guidance, similar to that provided at US-281 and Evans Road, may reduce initial driver confusion and downstream lane changes, but may also reduce lane balance. This could result in a small loss of capacity compared to less specific lane guidance.

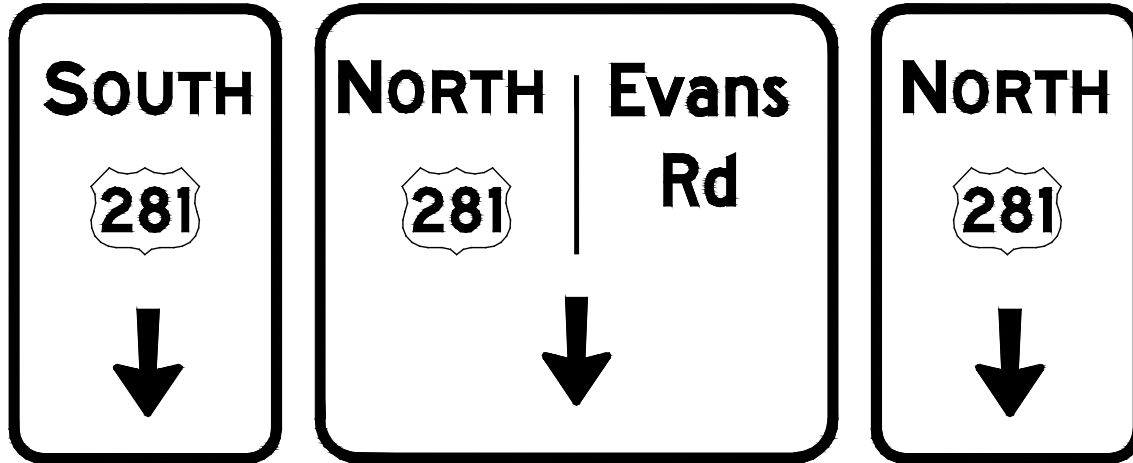

Exhibit 8-13. Overhead lane use signs provided on minor street (Evans Road) approaching major street (US-281 in San Antonio, TX).

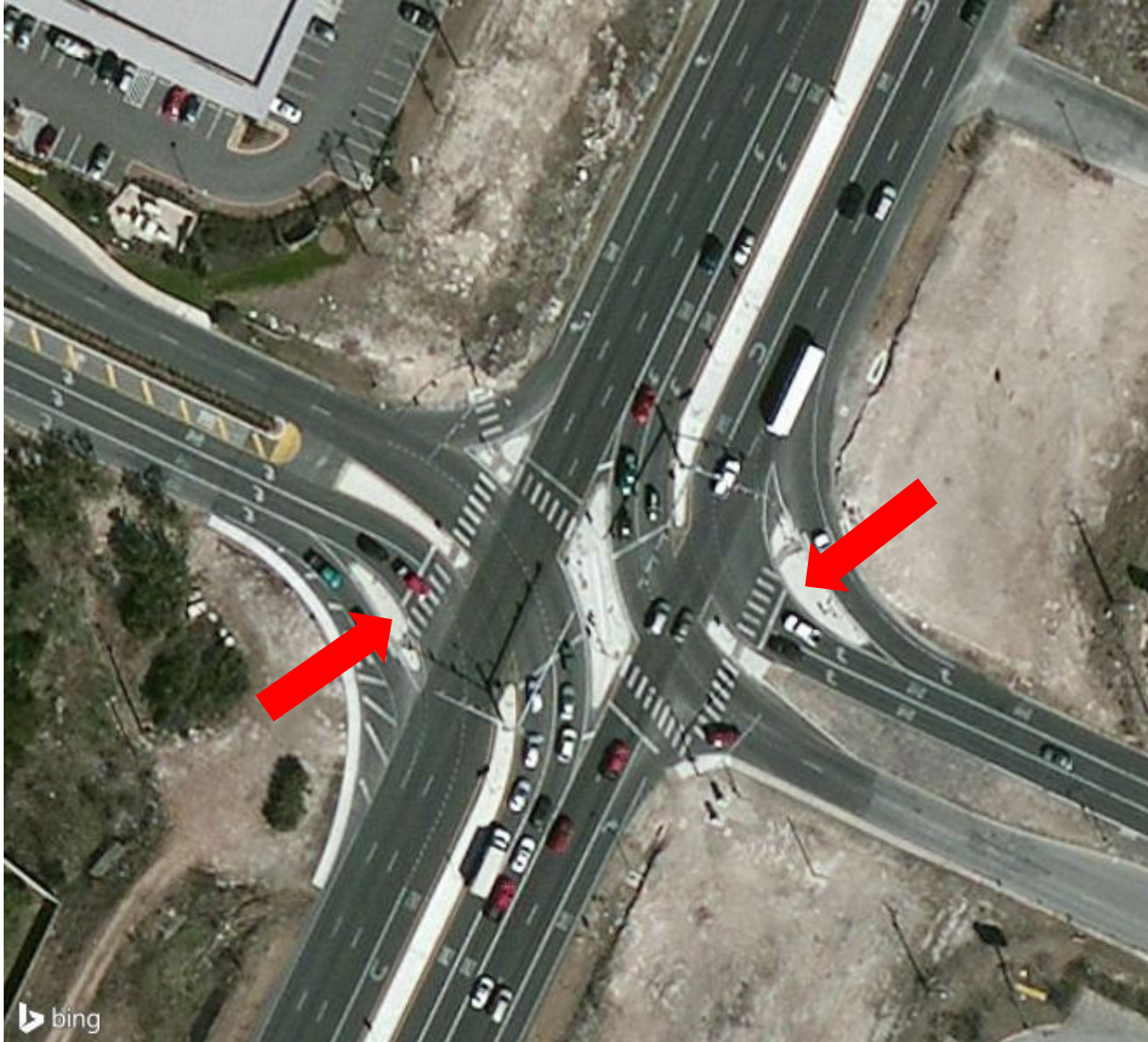

Exhibit 8-14. RCUT intersection with traffic island separating minor street right turn movements from minor street through and left turn movements.⁽²⁾

The overhead lane use signs are shown in Exhibit 8-15. A RCUT intersection in North Carolina on US-15/501 and Erwin Road and Europa Drive in Chapel Hill also used overhead signing for the major street, as shown in Exhibit 8-15. The RCUT intersection does not have major street left-turn crossovers (major street left-turning vehicles must drive beyond the main intersection and use the U-turn crossover). This unusual turning pattern justified the expense of large overhead signs mounted on trusses spanning the street. Aside from the special cases cited here, most signalized RCUT intersections in the United States do not use overhead signs.



Exhibit 8-15. Overhead guide signs at the RCUT intersection on US-15/501 in Chapel Hill, NC.⁽²⁷⁾

Stop-Controlled

The principles behind signing a stop-controlled RCUT intersection are similar to those for a signal-controlled RCUT intersection. In some ways the issues are more simple for the stop-controlled case because the demands are lighter and minor street and crossovers are typically single-lane approaches. Exhibit 8-16 shows a signing and marking plan for a stop-controlled RCUT intersection developed by NCDOT. The plan in Exhibit 8-16 does not call for guide signs because the minor street is a low-volume street primarily serving local drivers. Exhibit 8-16 also does not show stop or yield signs for the U-turn crossovers; in Maryland there are also U-turn crossovers with no stop or yield signs. Other agencies routinely use stop or yield signs to control U-turn crossovers. MDOT has used either stop signs or yield signs in U-turn crossovers while Louisiana has used yield signs. Yield signs reduce the need to stop, which reduces delay.

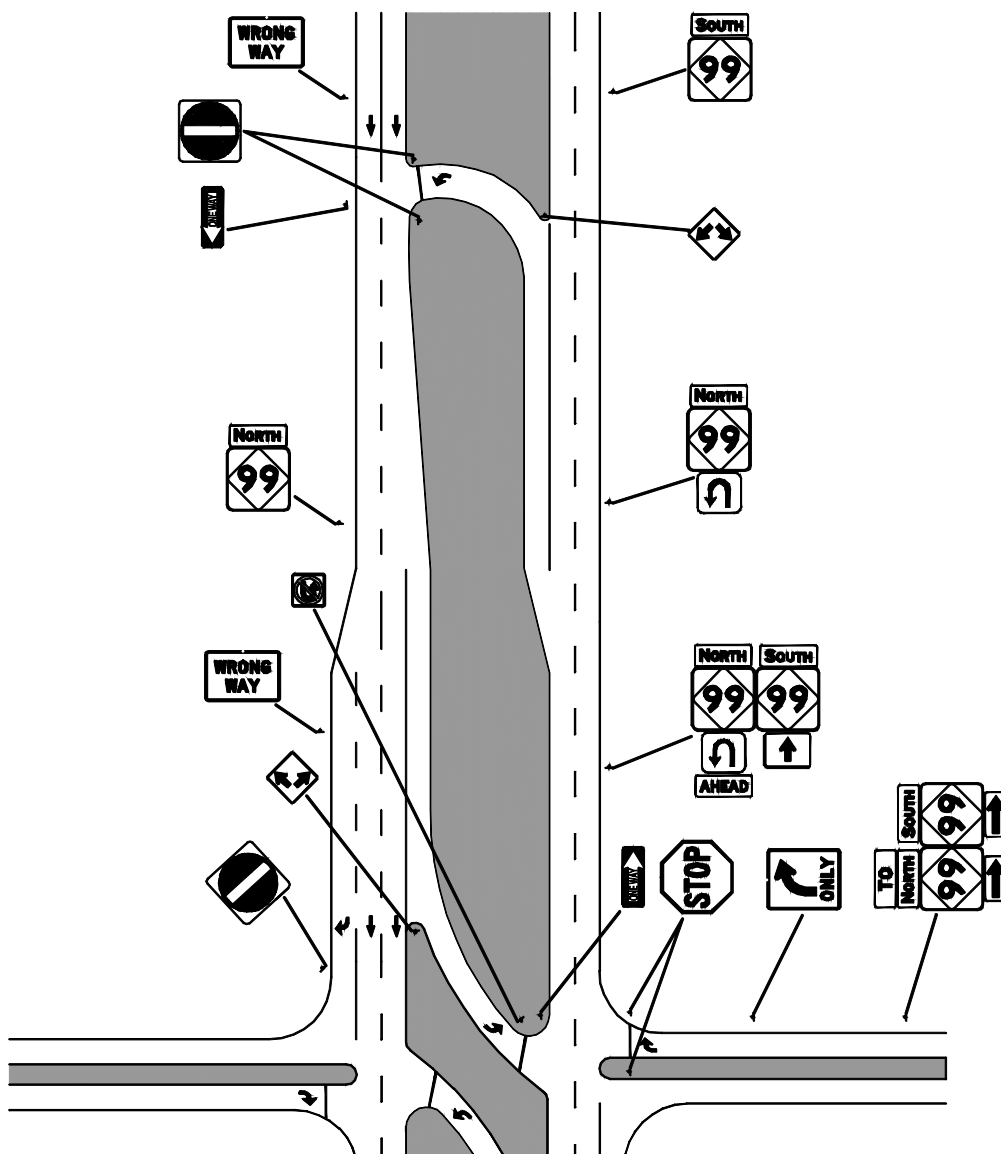

Exhibit 8-16. Stop-controlled RCUT intersection signing guidance from NCDOT practice.⁽⁴⁰⁾

Merge-Controlled

The signing plan for a merge-controlled RCUT intersection will be similar to a stop-controlled RCUT intersection. Exhibit 8-17 shows signing at a merge-controlled RCUT intersection in Maryland. The minor street approach and left-turn crossovers have yield signs. Exhibit 8-17 also shows flashing yellow beacons above the intersection for the major street to provide more warning to drivers. Speed limits of 55 mph or above on the major street, and the fact that the major street at these installations are in fact rural expressways, may mean that green guide signs prior to the U-turn crossovers, as shown previously in Exhibit 8-12, can help drivers navigate more easily.



Exhibit 8-17. Signing at a merge-controlled RCUT intersection in Emmitsburg, Maryland.⁽³⁾

PAVEMENT MARKINGS

Pavement markings are an integral part of the information system at a RCUT intersection. On minor street approaches, each lane could have right-turn arrow markings, repeated several times, supplemented with the word “ONLY.” Left-turn arrows or left and through arrows could be placed near the stop bar the markings, as appropriate. In left-turn crossovers, each lane could have left-turn arrow markings, repeated several times, supplemented with the word “ONLY.” On the minor street approaches and in the crossovers, the arrows could be supplemented with route numbers or street names.

The MUTCD does not provide guidance for pavement markings at RCUT intersections. However, MDOT has developed pavement marking standards for U-turn crossovers at MUT intersections in Michigan that could be used at the U-turn portion of a RCUT intersection.⁽²⁸⁾ Exhibits 8-18 and 8-19, developed by MDOT, provide typical pavement marking for U-turn crossovers with single and dual U-turn lanes, respectively. The pavement marking concepts from the figures follow the general pavement marking concepts in the MUTCD. While not specifically shown in Exhibits 8-18 and 8-19, stop bars could be placed across the lane(s) of the U-turn crossover. The MUTCD requires stop bars to be placed no more than 30 feet or less than 4 feet from the nearest edge of the pavement.

In the deceleration and storage lanes leading to U-turn crossovers, each lane could have U-turn arrow markings, repeated several times, supplemented with the word “ONLY.”

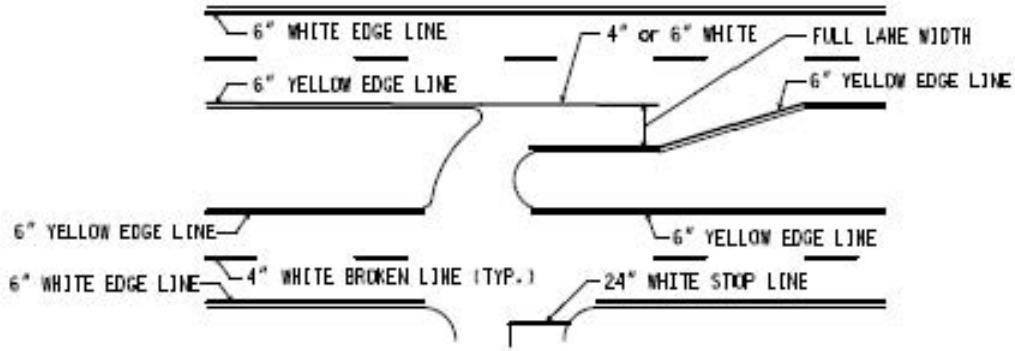

Exhibit 8-18. Typical pavement marking at a directional crossover.⁽²⁸⁾

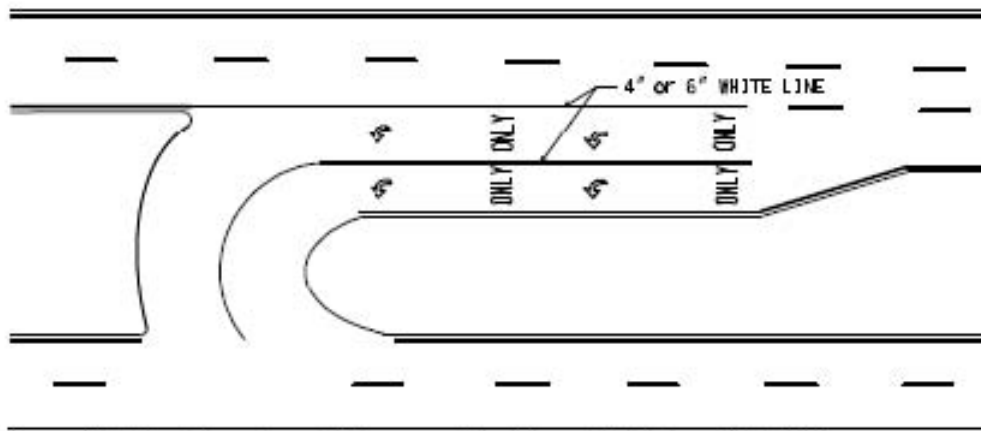

Exhibit 8-19. Pavement markings at a directional crossover with dual lanes.⁽²⁸⁾

LIGHTING

Lighting standards and specifications outlined in AASHTO's *Street Lighting Design Guide*, FHWA's *Lighting Handbook*, and the Illuminating Engineering Society of North America (IESNA) publications including *American National Standard Practice for Street Lighting* can be used to determine optimal lighting for RCUT intersections.^(41,42,43)

Based on national lighting guidance, agencies establish street lighting design guidelines along their facilities based on the road functional classification and pedestrian conflict area classifications. Intersection lighting is typically 1.5 times the street lighting along the approaches, or the street lighting of the two crossing streets are added together to determine the lighting guidelines for the intersection.

Generally, signalized RCUT intersections are constructed on streets with high traffic volumes likely meeting the corridor volume criteria for lighting. It is desirable to light the main and crossover intersections according to the determined intersection light levels. Depending on the intersection spacing, the light levels for the road segments between the intersections may be reduced to street segment light levels. If there is no lighting along the approaches, then transition lighting coming from dark into light and vice versa may enhance user experience and

performance. Even with sufficient lighting provided for the overall intersection, additional supplemental lighting could be added in the median to illuminate the pedestrian refuge area.

Lighting at a stop- or merged-controlled RCUT intersection will follow similar lighting criteria as conventional intersections. These types of RCUT intersections are more likely to be located on a street without continuous lighting.

This page intentionally left blank.

CHAPTER 9 – CONSTRUCTION AND MAINTENANCE

This chapter provides an overview of the general considerations of constructing and maintaining a RCUT intersection. It also discusses law enforcement considerations. While there are differences in constructing, maintaining, and providing law enforcement at a RCUT intersection compared to a conventional intersection, the differences is likely do not overshadow the safety and operational benefits discussed in previous chapters.

CONSTRUCTION

Alabama, Louisiana, Maryland, Michigan, Minnesota, Missouri, North Carolina, Ohio, Tennessee, and Texas have constructed RCUT intersections and could serve as resources for construction planning guidance. As with any new type of street construction, additional communication and coordination with construction contractors may streamline project implementation. Understanding lessons learned from agencies having developed RCUT intersections may reduce construction delays.

Construction Staging

This section provides insights about maintaining traffic while constructing an RCUT intersection under two conditions. The first condition is when widening a street. The second condition is when converting an existing conventional intersection to a RCUT intersection.

The general construction sequence and traffic shifts for a project widening a street can include:

1. Building the lanes that carry one direction of travel on new alignment. This is illustrated in stage 1 of Exhibit 9-1 with the new lanes being built for the eastbound direction of travel.
2. Shifting the existing traffic to the new eastbound lanes. The intersection would be shifted as well and would continue to operate conventionally. Stage 2 of Exhibit 9-1 shows this shift.
3. Constructing portions of the lanes that will serve the westbound direction of the arterial, the U-turn crossovers, and the portions of the left-turn crossovers that do not overlap the existing minor street. This step is illustrated in stage 2 of Exhibit 9-1.
4. Shifting westbound traffic onto their lanes, allowing eastbound traffic to use all of their lanes, shifting minor street through traffic and all left-turning traffic to the U-turn crossovers, and closing the existing intersection to through movements from the side street. This is shown in stage 3 of Exhibit 9-1.
5. Finishing the left-turn crossovers within the center of vacated intersection, as illustrated in stage 3 of Exhibit 9-1.
6. Shifting traffic to the permanent RCUT intersection configuration following completion of the left-turn crossovers, as illustrated in the bottom graphic of Exhibit 9-1.

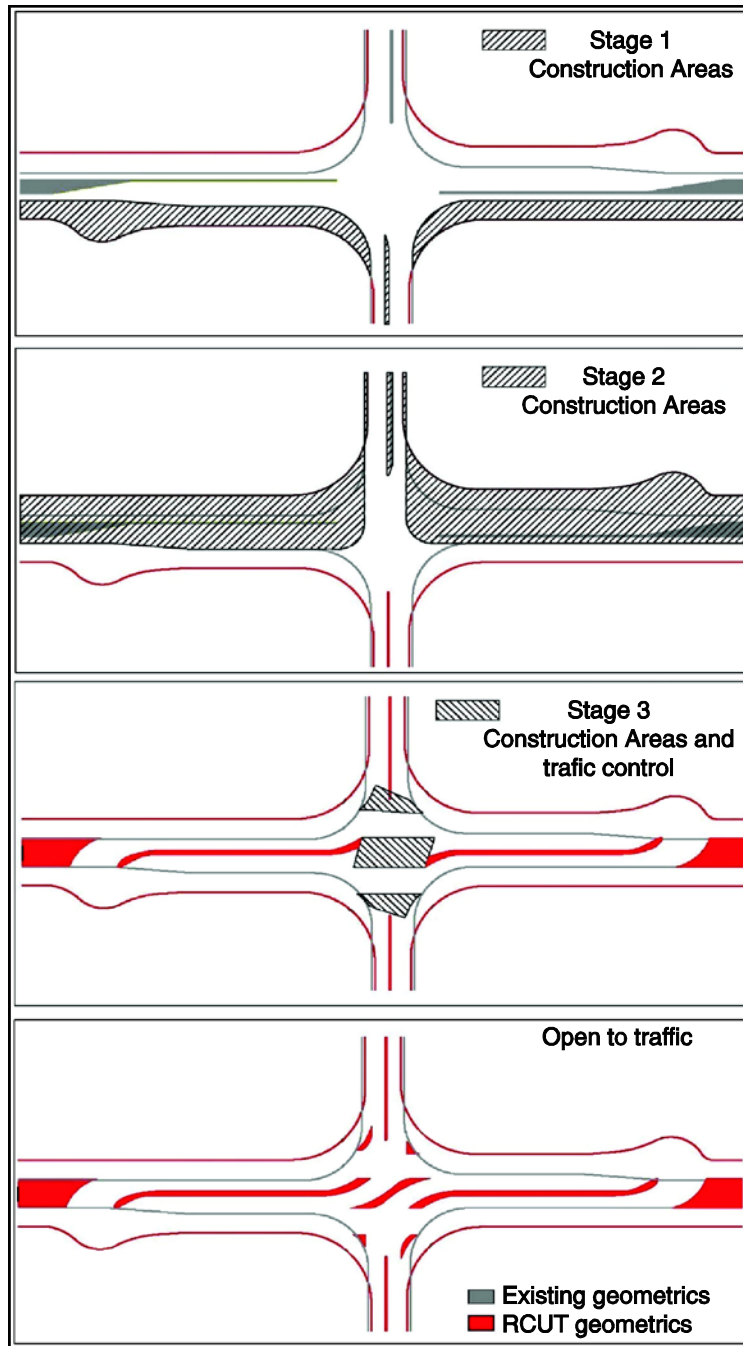

Exhibit 9-1. Construction staging when widening the street when converting two-lane road to multilane RCUT intersection.⁽³⁾

The general sequencing for converting an existing conventional intersection to a RCUT intersection is shown in Exhibit 9-2 and described as follows:

1. Constructing portions of the U-turn crossovers and the portions of the left-turn crossovers that do not overlap the existing minor street. This is shown as stage 1 in Exhibit 9-2.

Restricted Crossing U-turn Informational Guide

2. Shifting minor street through traffic and all left-turning traffic to the U-turn crossovers and closing the conventional intersection, as shown in stage 2 of Exhibit 9-2.
3. Completing the left-turn crossovers while vacating the center of the intersection. This is shown as stage 3 in Exhibit 9-2.
4. Shifting traffic to the permanent RCUT intersection configuration following completion of the left-turn crossovers. This is shown in the bottom graphic of Exhibit 9-2.

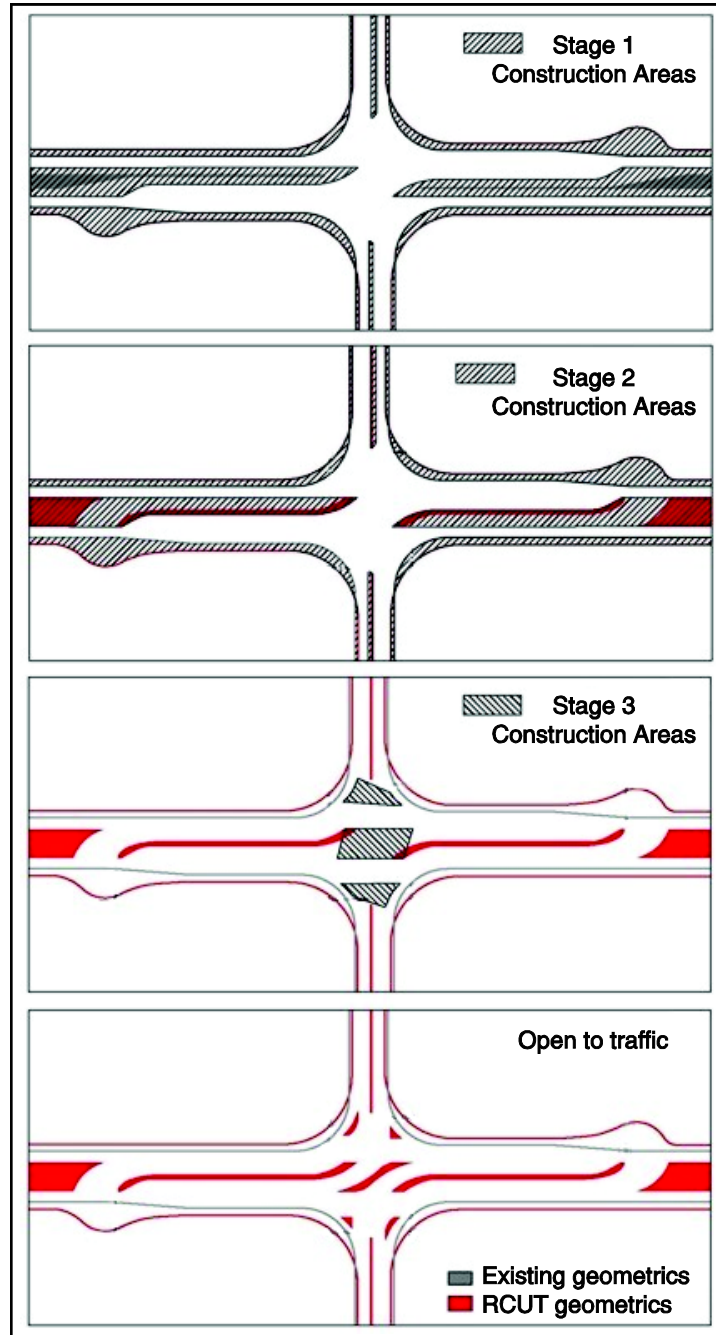

Exhibit 9-2. Construction staging for converting a conventional intersection to a RCUT intersection.⁽³⁾

Work Zone Traffic Control

Work zone traffic control to construct a RCUT intersection can use typical traffic control devices. Part 6 of the MUTCD addresses temporary signals, signs, and markings.⁽⁷⁾ MUTCD guidance can be adapted to RCUT intersection construction.



A RCUT intersection construction project may need more specialized work zone traffic control compared to conventional intersection construction when all left-turns and minor street through movements are using the U-turn crossovers (stage 3 in Exhibits 9-1 and 9-2). Temporary guide signing will likely be needed to direct motorists because major street left turns are rerouted from their traditional location (at a conventional intersection or at a RCUT intersection) and because it is the first time the RCUT traffic pattern is imposed on minor street drivers. Temporary changeable message signs on the minor street approach, on the major street approach to the main intersection, and at the U-turn crossovers may be beneficial at RCUT intersection work zones during stage 3.

COSTS

A RCUT intersection will likely be more expensive to construct than a conventional intersection. This is likely attributable to right-of-way needs, extra signals and controllers, and extra pavement. Planning and design costs may initially be higher for the first few RCUT intersections compared to a conventional intersection, in part because of extra public outreach, digital renderings, and traffic operations microsimulation video clips. As RCUT intersections become more common in an area, special efforts and costs will likely be reduced.

Exhibit 9-3 provides a range of locations and approximate costs for a variety of RCUT intersection projects. Actual project costs will vary depending on each project's location and unique contextual design environment.

Exhibit 9-3. Summary of costs associated with RCUT intersections.

Location and features	Open to Traffic	Cost	Image
<p>US 15/501, Chapel Hill, NC Widened street from 4 to 6 lanes Relocated frontage road 0.4 mile corridor</p>	2006	\$5 million	
<p>US 17 near Wilmington, NC 3 signalized RCUT intersections (only 1 pictured at right) 0.6 mile corridor</p>	2006	\$2 million	
<p>US 301 and MD 313, Kent County, MD Stop signs on minor street approach Crossovers 1400 feet from main intersection</p>	2005	\$618,000	

The following discussion provides a theoretical cost estimate of a signalized RCUT intersection compared to four conventional intersections.⁽³⁾ This exercise is meant to provide a relative cost comparison between a potential RCUT and alternative conventional intersection forms. The comparison assumes no special grading or construction features are required. It also assumes the mobilization, overhead lighting, pavement marking, and drainage costs were not significantly different between the two types of intersections. Unit cost prices were obtained from the 2006 *RS Means Heavy Construction Cost Book*.⁽⁴⁴⁾

Four kinds of conventional intersections, shown in Exhibit 9-5, were assumed as alternatives to the RCUT intersection treatment. Four signal mast arms would be needed at the main intersections of all alternatives, and two more mast arms would be needed at each crossover of the RCUT intersection:

1. Major street with wide median and four-lane side street
2. Major street with wide median and two-lane side street
3. Major street with narrow median and four-lane side street
4. Major street with narrow median and two-lane side street

The comparison RCUT intersection alternative has dual-lane crossovers and is shown in Exhibit 9-4; this is the same configuration depicted previously in Chapter 7. Exhibit 9-5 shows the conventional intersection configurations used for the cost comparison.

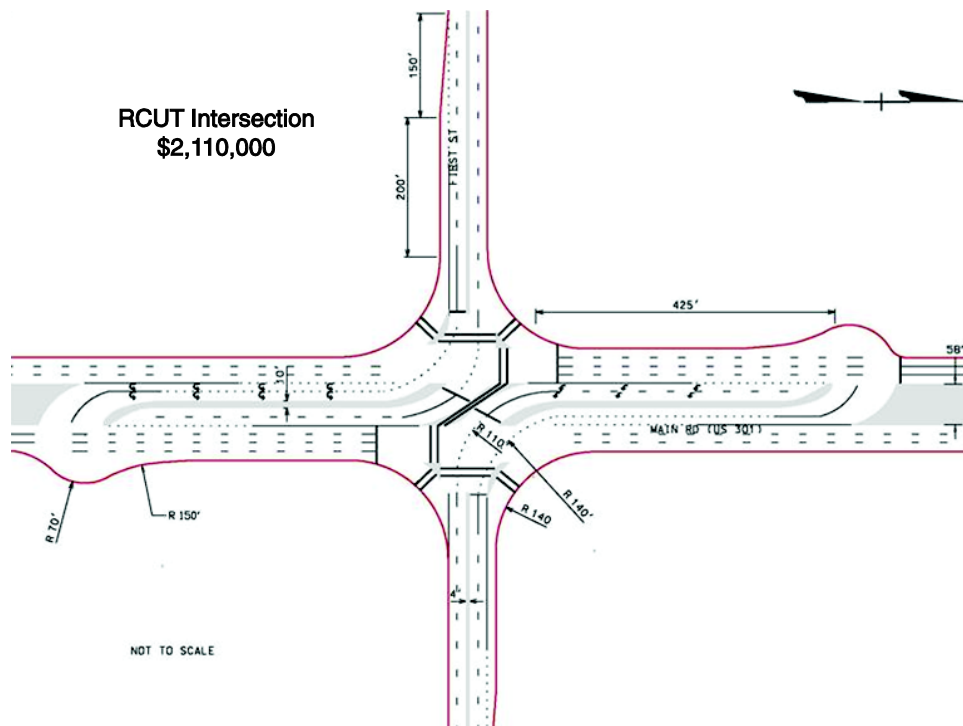

Exhibit 9-4. RCUT intersection used in theoretical cost comparison.⁽³⁾

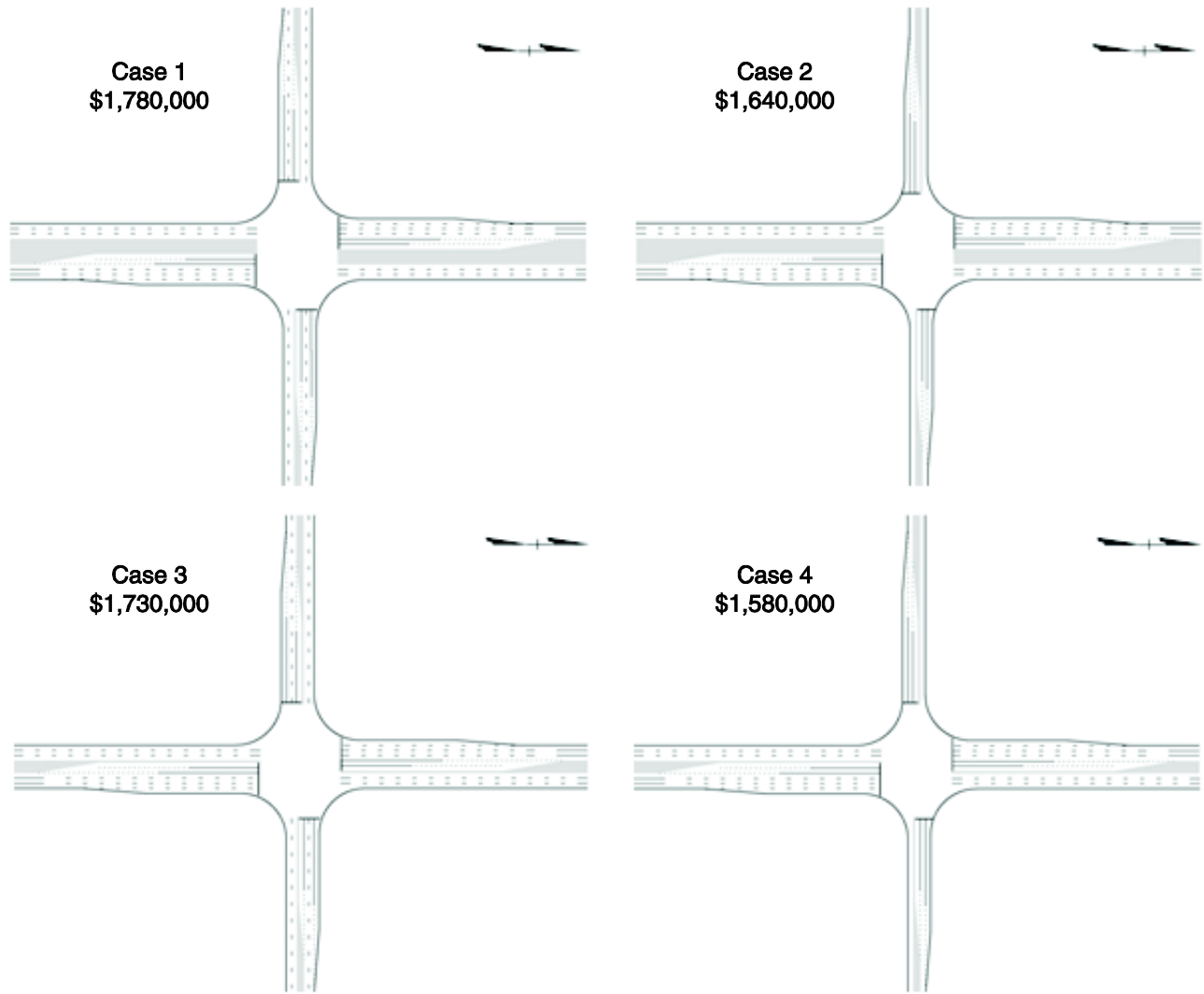
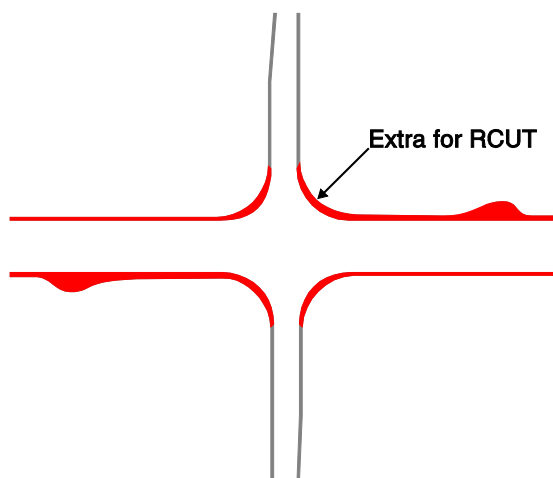

Exhibit 9-5. Conventional intersection alternatives used for cost comparison.⁽³⁾

The RCUT costs estimates range from 18- to 34-percent more than a conventional intersection.

Exhibit 9-6 shows the RCUT intersection requires additional right-of-way to varying degrees when compared to the conventional intersection. Compared to a conventional intersection with a wide median for the major street, the significant addition for the RCUT intersection is at the loons. On the other hand, if the conventional intersection major street has a narrow median, the right-of-way amount for the RCUT intersection would be greater.



a. Footprint comparison of a RCUT intersection versus a conventional intersection with a wide median and a four-lane side street

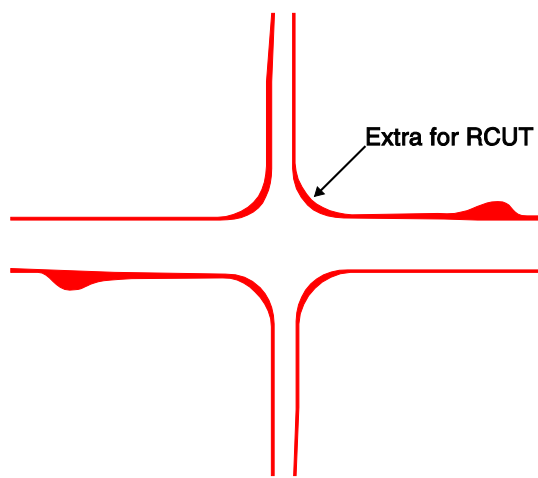

b. Footprint comparison of a RCUT intersection versus a conventional intersection with a wide median and a two-lane side street

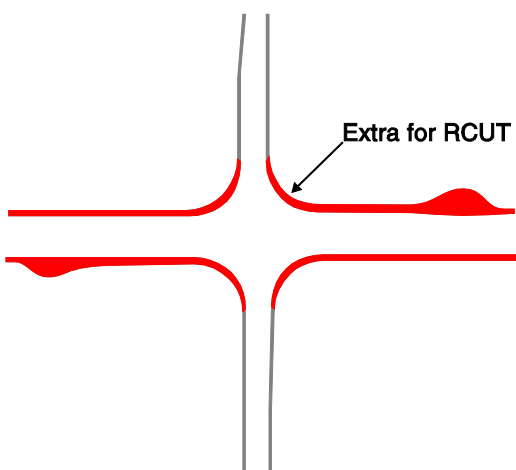

c. Footprint comparison of a RCUT intersection versus a conventional intersection with a narrow median and a four-lane side street

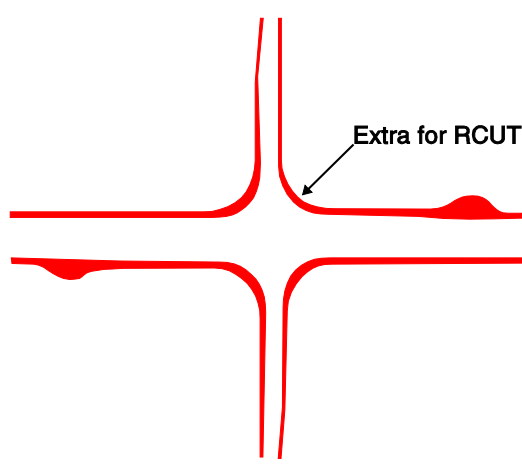

d. Footprint comparison of a RCUT intersection versus a conventional intersection with a narrow median and a two-lane side street

Exhibit 9-6. Footprint comparisons of a RCUT intersection versus conventional intersections.

MAINTENANCE

Maintaining a RCUT intersection is similar to a conventional intersection. Maintaining pavement and striping of the U-turn crossover lanes is similar to left-turn lane maintenance at a conventional intersection, although it can be more challenging due to the confined nature of the channelized area. In both cases, maintenance of left-turn lanes requires temporarily closing the lane and detouring traffic. Like for conventional streets, conducting maintenance activities

during off-peak times can minimize traffic disruptions. In addition, this process generally follows the appropriate work zone guidelines as for all conventional intersections. Where RCUT intersections are part of a continuous corridor, maintenance can be done at one crossover while vehicles can use the next primary intersection. Maintaining signals and lighting at RCUT intersections is also similar to conventional intersection signal maintenance, although there are generally more signals and lighting to maintain. In most cases, RCUT intersections provide the advantage of being able to locate utility vehicles in the median to work on overhead signal and lighting fixtures, where utility vehicles at conventional intersections may have to block travel lanes or locate on private property to perform maintenance functions.

A RCUT intersection likely needs a larger median and/or right-of-way than a comparable conventional intersection, which may increase maintenance costs. Wider RCUT intersection medians create opportunities for landscaping. This could be more expensive than at a conventional intersection but offers intangible benefits to road users and nearby land users.

Snow Removal

Snow removal for a RCUT intersection is accomplished similar to a conventional intersection. Through lanes are plowed as part of the corridor and snow is systematically pushed to the outside of the street. Snow removal for the U-turn crossover is similar to a conventional left-turn lane. These are typically plowed after the through lanes, and snow is pushed through the crossover to the opposite side of the street. The same technique is used for when a loon is part of the RCUT intersection. Snow is pushed through the U-turn crossover to the opposite side of the loon.

LAW ENFORCEMENT NEEDS

There are unique law enforcement needs at a RCUT intersection. Drivers travelling through a RCUT intersection on the major street operate no differently than at a conventional intersection. However, traffic on the minor street has no choice but to turn right.

Wrong-way movements and red-light-running at the crossovers has been observed at RCUT intersections in North Carolina.⁽³⁾ Enhanced enforcement during the periods after the RCUT intersections are initially opened to traffic could help drivers become familiar with intended operations and help reduce prohibited maneuvers. As the novelty of the new intersection operations subsides, the need for extra enforcement will likely diminish.

Drivers at rural RCUT intersections in North Carolina have been observed making direct left turns from the minor streets by traveling over the traffic islands.⁽³⁾ This could be a specific and unique law enforcement need at RCUT intersections compared to conventional intersection forms. NCDOT specifies curbs be included on the traffic islands at rural RCUT intersections to discourage this violation. Delineators and object markers could also be used on the traffic islands.

The area within a loon must be kept clear of parked or stopped vehicles. “No parking or standing” signs prominently displayed and the presence of law enforcement could reduce parked or stopped vehicles. Establishing a policy of towing vehicles parked in loons will be a unique enforcement need not found at conventional intersection forms.

Progression speeds and large progression bands may result in self-enforcing speeds in RCUT corridors compared to conventional arterial corridors.⁽³⁾ In a signalized RCUT corridor, with the progression provided, drivers should learn to travel within the progression speed. This could potentially reduce speed enforcement needs in signalized RCUT corridors.

This page intentionally left blank.

REFERENCES

1. Kramer, R.P. New Combinations of Old Techniques to Rejuvenate Jammed Suburban Arterials, Strategies to Alleviate Traffic Congestion,” Conference Proceedings, pp. 139–148, Institute of Transportation Engineers: Washington, DC., 1987.
2. Bing Maps. <http://www.bing.com>
3. FHWA. *Alternative Intersection/Interchanges: Informational Report (AIIR)*, Report No. FHWA-HRT-09-060. Washington, DC: USDOT, 2010.
4. North Carolina Department of Transportation. Superstreet Intersection brochure webpage. <http://www.ncdot.gov/projects/PoplarTentRoad/download/SuperstreetBrochure201301.pdf>.
5. American Association of State Highway and Transportation Officials (AASHTO). *A Policy on the Geometric Design of Highways and Streets*. Washington, DC: AASHTO, 2011.
6. Transportation Research Board (TRB). *Highway Capacity Manual (HCM)*. Washington, DC: TRB, National Research Council (NRC), 2010.
7. Federal Highway Administration (FHWA). *Manual on Uniform Traffic Control Devices*. Washington, DC: U.S. Department of Transportation (USDOT), 2009.
8. AASHTO. *Highway Safety Manual (HSM), 1st Edition*. Washington, DC: AASHTO, 2010.
9. Cunningham, C.M., Miller, M., Findley, D., Schroeder, B., Katz, D., Foyle, R., Smith, S. and D. Carter, Economic Effects of Access Management Techniques in North Carolina. FHWA/NC/2009-12, 2010.
10. Haley, R., Ott, S, Hummer, J.E., Cunningham, C.M., Foyle, R., and B.J. Schroeder. Operational Effects of Signalized Superstreets in North Carolina, Journal of the Transportation Research Board – TRR Issue 2223, TRB, Washington, D.C, 2011.
11. Hummer, J.E., R.L. Haley, S.E. Ott, R.S. Foyle, and C.M. Cunningham, "Superstreet Benefits and Capacities," Final Report, FHWA/NC/2009-06, NC Department of Transportation, Raleigh, December 2010.
12. Inman, V.W. and R.P. Haas, “Field Evaluation of a Restricted Crossing U-turn Intersection,” FHWA-HRT-11-067, June 2012.
13. Ott, S.E., R.L. Haley, J.E. Hummer, R.S. Foyle, and C.M. Cunningham, “Safety Effects of Unsignalized Superstreets in North Carolina,” *Accident Analysis and Prevention*, Volume 45. 2012.
14. Edara, P., C. Sun, and S. Breslow, “Evaluation of J-turn Intersection Design Performance in Missouri,” report cmr 14-005, Missouri Department of Transportation, Jefferson City, December 2013.
15. North Carolina Department of Transportation. Superstreet Intersection informational web page. <http://www.ncdot.gov/projects/PoplarTentRoad/download/SuperstreetGraphic.pdf>.

16. Minnesota Department of Transportation. Reduced Conflict Intersection video webpage. <http://www.youtube.com/watch?v=c5pBnuu1Cno>.
17. Minnesota Department of Transportation. Reduced Conflict Intersection video with truck drivers webpage. <http://www.youtube.com/watch?v=WebW5JZNrT8&feature=youtu.be&t=4m50s>. Video permission from Missouri Department of Transportation.
18. FHWA, USDOT FHWA Information Videos, web page. <https://www.youtube.com/user/USDOTFHWA>
19. FHWA, Safety Program Informational Brochures, web page. <http://safety.fhwa.dot.gov>.
20. ADA.gov. "Information and Technical Assistance on the Americans with Disabilities Act." http://www.ada.gov/2010ADASTandards_index.htm
21. Ray, B., et al., *NCHRP 15-34A: Performance-Based Analysis of Geometric Design of Highways and Streets*, Contractor Final Report. Washington, DC: Transportation Research Board of the National Academies, 2014.
22. The United States Access Board, Accessible Public Rights of Way webpage. <http://www.access-board.gov/>
23. FHWA and AASHTO. Results of Joint AASHTO/FHWA Context Sensitive Solutions Strategic Planning Process, Summary Report. Raleigh, NC.: Center for Transportation and the Environment, North Carolina State University, 2007.
24. Hummer, J.E., A.M. Holzem, N.M. Roupail, C.M. Cunningham, S.W. O'Brien, B.J. Schroeder, K. Salamati, and R.S. Foyle, "Pedestrian and bicycle Accommodations on Superstreets," North Carolina Department of Transportation, Final Report, Project: 2012 – 13, January 2014.
25. Google Inc. Google Earth. Accessed July 2014
26. Federal Highway Administration (FHWA). *Designing Sidewalks and Trails for Access*. USDOT: Washington, DC, 2001.
27. North Carolina Department of Transportation. Photo Credit.
28. Michigan Department of Transportation (MDOT). *Geometric Design Guide 670*, Lansing, MI: MDOT, 1993.
29. FHWA. *Crash Modification Factors Clearinghouse*. <http://www.cmfclearinghouse.org/>
30. Rodegerdts, L. A., Nevers, B., and Robinson, B., "Signalized Intersections: Informational Guide." FHWA-HRT-04-091, (2004)
31. Federal Highway Administration. A Guide to Developing Quality Crash Modification Factors webpage. <http://safety.fhwa.dot.gov/tools/crf/resources/fhwasa10032/>.

32. Federal Highway Administration (FHWA). *Traffic Analysis Toolbox*.
<http://www.fhwa.dot.gov/publications/research/infrastructure/pavements/ltp/04038/index.cfm>
33. Kramer, R. "Superstreet Design Made Easy." Presentation to NCSITE Signal Systems Users Group, July 2, 2012.
34. Kim, T. Edara, P., and Bared, J.G. (2006). "Traffic Efficiency of Two Non-Traditional Intersections; Super Street and Through-About," Presented at 7th Conference on Access Management, Park City, Utah.
35. The Texas Highway Man. [San Antonio Area Roads and More: Superstreets webpage](http://www.texashighwayman.com/superstreets.shtml),
<http://www.texashighwayman.com/superstreets.shtml>. 1-10-2014.
36. Federal Highway Administration, University of Central Florida. CAP-X webpage.
<http://tsi.cecs.ucf.edu/index.php/cap-x/release-info>
37. North Carolina Department of Transportation. (2005). *Street Design Manual Part I*, Section 4, Rev. 4, Chapter 9, Street Design Branch. Obtained from:
www.ncdot.org/doh/preconstruct/altern/value/manuals/RDM2001/part1/chapter9/pt1ch9.pdf
38. Hummer, et al., "Taking Advantage of the Flexibility Offered by Unconventional Designs," ITE Journal, September 2012.
39. Sisiopiku, V. and Aylsworth-Bonzelet, L. (2003). "Application of Loops at Directional Crossovers," Presented at the 82nd Annual Meeting of the Transportation Research Board, Washington, DC.
40. North Carolina Department of Transportation. (2007). Typical for Super Street Signing. Traffic Engineering and Safety Systems Branch.
<http://www.ncdot.org/doh/preconstruct/traffic/congestion/docs/RCUT.pdf>.
41. AASHTO. *Roadway Lighting Design Guide*. Washington, DC: AASHTO, 2005.
42. FHWA. *Street Lighting Handbook*. Washington, DC: USDOT, 1978.
43. Illuminating Engineering Society of North America (IESNA). *Recommended Practices for Roadway Lighting*. New York, NY: IESNA, 2000.
44. Spencer, E.R. RS Means Heavy Construction Cost Data 2006.

This page intentionally left blank.

Appendix A CATALOG OF ALL KNOWN INSTALLATIONS IN THE UNITED STATES

Exhibit A-1 presents location information for all known installations of RCUT intersections in the United States.

Exhibit A-1. Known installations of RCUT intersections in the United States

Intersection	Location	Type	Built
Plum Road & US 231	Dothan, AL	Signal	2009
Retail Drive & US 231	Dothan, AL	Signal	2009
Northwest of Plum Road & US 231	Dothan, AL	Stop	2009
Rock Bridge Road & US 231	Dothan, AL	Stop	2009
Buyers Drive & US 231	Dothan, AL	Stop	2009
Veterans Boulevard Corridor	Kenner, LA	Stop or Merge	2005
US 61 & Leblanc's Food Store	Gonzales, LA	Stop or Merge	2007
LA-8/LA-28 & LA-117	Leesville, LA	Stop or merge	2011
Loyola Drive & 31 st Street	Kenner, LA	Stop or Merge	
US-15 north of Frederick	Maryland	Merge	
US-301 west of Delaware	Maryland	Merge	
Big Beaver & Lakeview Drive	Troy, MI	Signal	1990s
Long Lake & Corporate/Investment Drive	Troy, MI	Signal	1990s
County Road 24	Willmar, MN	Stop	
US 169 & County Road 3	Belle Plaine, MN	Stop	
Highway 36 and Keats Avenue	Lake Elmo, MN	Merge	
US 10 and County Road 8	Becker, MN	Stop	
US 169 and 173 rd Street	Jordan, MN	Stop	
US 212 and Highway 284	Cologne, MN	Stop	
Highway 65 and 169 th Avenue	Ham Lake, MN	Stop	
US 53 and County Road 52	Cotton, MN	Stop	
US 52 and County Road 66	Vermillion, MN	Stop	2014
US 169 and Highway 22	St. Peter, MN	Stop	2014
US 169 and St. Julien Street	St. Peter, MN	Stop	2014
US-63 at Deer Park Road	Jefferson City, MO	Stop	
US-54 at Honey Creek Road	Jefferson City, MO	Stop	
US-54 at Route-E	Jefferson City, MO	Stop	
MO-13 at Old MO-13	Jefferson City, MO	Stop	
Route-M at Lemay Ferry Road	Jefferson City, MO	Stop	
US 17 & Lanvale Road	Leland, NC	Signal	2007
US 17 & Brunswick Forest Parkway	Leland, NC	Signal	2007
US 17 & Grandiflora Drive/Gate Drive	Leland, NC	Signal	2007
US 17 & Gregory Road	Leland, NC	Signal	2007

Restricted Crossing U-turn Informational Guide

Intersection	Location	Type	Built
US 17 & Waterford Way/Ploof Road	Leland, NC	Signal	2007
US 17 & Hospital Drive	Supply, NC	Signal	
US 17 & Old Ocean Highway	Supply, NC	Signal	
US 17 & Medical Center Drive	Supply, NC	Stop	
US 17 & Mt Pisgah Road	Supply, NC	Stop	
Carolina Beach Road (US 421) & Retail Center	Wilmington, NC	Signal	
US 15/501	Chapel Hill, NC	Signal	
NC 55 & West Holly Springs Road	Holly Springs, NC	Signal	2013
NC 55 & Green Oaks Parkway	Holly Springs, NC	Signal	2013
NC 55 & New Hill Road	Holly Springs, NC	Signal	2013
Ohio 4 & Symmes Road	Hamilton, OH	Signal	
Ohio 4 & Tylersville Road	Hamilton, OH	Signal	
Ohio 4 & Hamilton Mason Road	Hamilton, OH	Signal	
US-281 & Evans Road	San Antonio, TX	Signal	2010
Stone Oak Parkway/TPC Parkway	San Antonio, TX	Signal	2010
North Northwind Drive/Marshall Road	San Antonio, TX	Signal	2011
Loop-1604 & New Guilbeau/Shafenfield	San Antonio, TX	Signal	2011
TX-71 at FM-973/Fallwell Lane	Austin, TX	Signal	2014

Appendix B SUPPLEMENTAL OPERATIONAL AND SAFETY DETAILS

This appendix provides step-by-step examples for performing operational analysis at a RCUT intersection.

A step-by-step procedure for calculating the RCUT capacity is shown in Exhibit B-1.

- Start with the ideal capacity of 1900 passenger cars per hour per lane (pcphpl)
- Adjust for lost time at 8% of the cycle, $1900 * .92 = 1750$ pcphpl
- Adjust for trucks at 5% of the vehicle population, $1750 * 0.95 = 1660$ vehicles per hour per lane (vphpl)
- Split the cycle so that the U-turn crossover receives one-third of the time, $1660 * 0.333 = 553$ vphpl
- Adjust for U-turns using a factor of 0.8 (as discussed in Chapter 6), $553 * 0.8 = 442$ vphpl
- Total demand in dual lane U-turn crossover = $442 * 2 = 884$ vph
- Assume that the minor street carries as many right turns as half the left plus through demand, so total minor street approach demand = $884 + 884/2 = 1330$ vph
- Assume a 55/45 directional split on the minor street, outbound direction = $1330 * (45/55) = 1090$ vph
- Total minor street peak demand = $1330 + 1090 = 2420$ vph
- Adjust for 0.92 peak hour factor, $2420 * 0.92 = 2230$ vph
- Adjust for 9% of daily traffic in the peak hour = $2230 / 0.09 = 24,800$ vehicles per day (vpd)

A demand of 25,000 vpd is characteristic of a moderately busy four-lane roadway. A RCUT intersection can be expected to serve volume on any two-lane minor street and light or moderate volume on four-lane minor streets. A similar calculation shows that the main street demand at capacity, with four lanes in each direction, is 82,000 vpd. If green time for the major street is increased to 85 percent, the major street demand at capacity—with four lanes in each direction—is about 105,000 vpd.

Exhibit B-1. RCUT capacity derivation.

Restricted Crossing U-turn Informational Guide

A step-by-step procedure for performing a critical lane analysis at an intersection with two, three, or four approaches is shown in Exhibit B-2. The procedure uses flow rates (demands) during the peak 15 minutes expressed as vehicles per hour.

1. Sketch the intersection geometry, including the numbers of lanes on each approach.
2. Assign demands to the appropriate approaches and lanes. Account for all flows. Assume a reasonable distribution of demand across multiple lanes.
3. Adjust turning demands for the relative inefficiency of the movements. Analysts can use default turn adjustment factors of 0.95 for a left turn, 0.85 for a right turn, and 0.8 for a U-turn in the absence of local factors.
4. Add the highest EB left-turn lane demand to the highest WB through or right-turn (if conflicting with left turn) lane demand.
5. Add the highest WB left-turn lane demand to the highest EB through or right-turn (if conflicting with left turn) lane demand.
6. Keep the higher of the result from step 4 or the result from step 5.
7. Add the highest NB left-turn lane demand to the highest SB through or right-turn (if conflicting with left turn) lane demand.
8. Add the highest SB left-turn lane demand to the highest NB through or right-turn (if conflicting with left turn) lane demand.
9. Keep the higher of the result from step 7 or the result from step 8.
10. Add the results from steps 6 and 9 to get the critical lane demand.
11. Compute capacity. Analysts can use default values of 1,600 vphpl for four basic phases, 1,650 for three basic phases, or 1,700 for two basic phases in the absence of local values. The number of non-zero numbers added to get step 9 is the number of basic phases at the signal.
12. Compute the critical v/c ratio as the result from step 10 divided by the capacity from step 11.
13. Identify the governing (highest) v/c for an intersection or interchange with multiple signals.

The default capacity values shown in step 11 are based on assumptions like those made in Chapter 5.

Exhibit B-2. Critical lane analysis procedure for signalized RCUT intersection.

Exhibit B-3 shows an example of the d/c critical lane calculation for the northern U-turn crossover at the RCUT depicted below. Demands in vehicles per 15 minutes are expressed as vehicles per hour.

1. 1. Volume diagram will be added here in Final RCUT Guide
2. The U-turn crossover demand = WBL + WBT = 130 vphpl. Assume that SB traffic is evenly distributed between the two through lanes, providing $(60 + 1900 + 50) / 2 = 1005$ vphpl.
3. Adjust turning demands for the U-turn crossover as $130 / 0.8 = 162$ vphpl.
4. At the U-turn crossover there is no EB left turn demand, so the result from this step is 162 vphpl.
5. At the U-turn crossover there is no WB left-turn or EB through or right-turn demand.
6. The higher of the result from step 4 or the result from step 5 is 162 vphpl.
7. There is no NB left-turn demand, so the result from this step is 1,005 vphpl.
8. There is no SB left-turn or NB through or right-turn demand.
9. The higher of the result from step 7 or the result from step 8 is 1,005 vphpl.
10. The critical lane demand is $162 + 1,005 = 1,167$ vphpl.
11. Since we added two numbers to achieve the result in Step 10, there are two basic phases at this signal and the capacity is 1,700 vphpl.
12. The critical v/c ratio is $1,167 / 1,700 = 0.69$.
13. Similar calculations for the other three signals show critical lane demands of 0.68 for the SB main intersection, 0.41 for the NB U-turn crossover, and 0.24 for the NB main intersection, so the SB U-turn crossover is the critical point at the RCUT during the peak period.

Exhibit B-3. Example v/c critical lane calculation for signalized RCUT.

An interim step-by-step procedure for the HCM analysis of a stop-controlled RCUT, until publication of the next edition of the HCM, is presented in Exhibit B-4.

1. Given the turning movement demand estimate, redistribute the demands across the RCUT as shown earlier in this chapter. For the remainder of this procedure, work with the redistributed demands.
2. Calculate control delays for the major street left-turn movements, which are made the same way as at a conventional intersection, using the LOS procedure in Chapter 19 of the 2010 HCM.
3. Calculate control delays for the minor street right turns at the main junctions, which include the minor street left-turn, through, and right-turn flows. These right turns are made the same way as at a conventional intersection, so the analyst can use the LOS procedure in Chapter 19 of the 2010 HCM. During the procedure, calculate the 95th percentile queue lengths in each storage bay and if spillback occurs consider using microscopic simulation. Use the calculated control delay to determine LOS for the minor street right turn.
4. Calculate control delays at each of the U-turn crossovers. The U-turn movement at the crossover is operationally analogous to a minor street right turn at a conventional intersection, so use Chapter 19 right turn parameters for the critical gap and other factors. During the procedure, calculate the 95th percentile queue lengths in each storage bay and if spillback occurs consider using microscopic simulation.
5. Calculate the travel times for vehicles moving from the main junction to the U-turn crossover and back.
 - For the movement from the main junction to the U-turn crossover, use the estimated free-flow speed multiplied by the distance from the junction to the crossover.
 - For a minor street through vehicle making the movement from the U-turn crossover back to the main junction, use the estimated free-flow speed multiplied by the distance from the junction to the crossover.
 - For a minor street left-turn vehicle making the movement from the U-turn crossover back to the main junction, use the estimated free-flow speed multiplied by the distance from the junction to the crossover plus five seconds (to account for deceleration and acceleration at the main junction).
6. Estimate the extra travel time for the minor street left turn and through vehicles by adding the control delay from step 3, the control delay from step 4, and the travel times from step 5.
7. Apply a LOS scale to the extra travel times from step 6 if desired.

Exhibit B-4. Interim HCM procedure of stop-controlled RCUT intersection.

An interim step-by-step procedure for the operational analysis of a signalized RCUT, until publication of the next edition of the HCM, is presented in Exhibit B-5.

1. Given the turning movement demand estimate, redistribute the demands across the RCUT as shown earlier in the chapter. For the remainder of this procedure, work with the redistributed demands.
2. Calculate control delays for all approaches to the four signals, using the “incremental queue analysis” delay estimation methodology from Chapter 18 of the 2010 HCM⁽¹²⁾. Use the appropriate saturation flow adjustment factor for U-turn crossovers. For multi-lane minor street approaches and U-turn crossovers, use appropriate lane utilization factors. Mimic LTOR and RTOR operations, where applicable, by analyzing the approaches as if they had protected-permissive signals, with the appropriate critical gap and follow-up times.
3. Calculate queue lengths in each crossover storage bay and compare to actual storage bay lengths. If the 95-percent queue length exceeds the storage bay provided, and if spillback occurs, consider using microscopic simulation.
4. Calculate the travel times for vehicles moving from the main junction to the U-turn crossover and back using the estimated free-flow speed multiplied by the distance from the junction to the crossover.
5. Estimate the overall control delays for minor street right turns from the control delay results of step 2.
6. Estimate the overall control delays for major street left turns, through movements, and right turns by adding the control delay from the U-turn crossover signal and the control delay from the signal at the main junction.
7. Estimate the extra travel time for the minor street left turn and through vehicles by adding the control delays from step 2 from each of the three signals those vehicles traverse and the travel times from step 4.
8. Apply a LOS scale to the overall control delays and extra travel times from steps 5 through 7 if desired.

Exhibit B-5. Interim HCM procedure of signalized RCUT intersection.

This page intentionally left blank.

Appendix C MARKETING AND OUTREACH MATERIALS

This appendix provides some examples of RCUT Public Outreach Material Examples.

FHWA has created alternative intersection and interchange informational videos and video case studies, which can be viewed on the FHWA YouTube channel (<https://www.youtube.com/user/USDOTFHWA>). Exhibit C-1 is an example of the type of information provided in the video for the Restricted Crossing U-Turn intersection.



Exhibit C-1. FHWA Restricted Crossing U-Turn Intersection Informational video.

In addition, FHWA has developed alternative intersection brochures that can be found on the FHWA website (<http://safety.fhwa.dot.gov>). An example of the Restricted Crossing U-Turn intersection brochure is shown to the right.

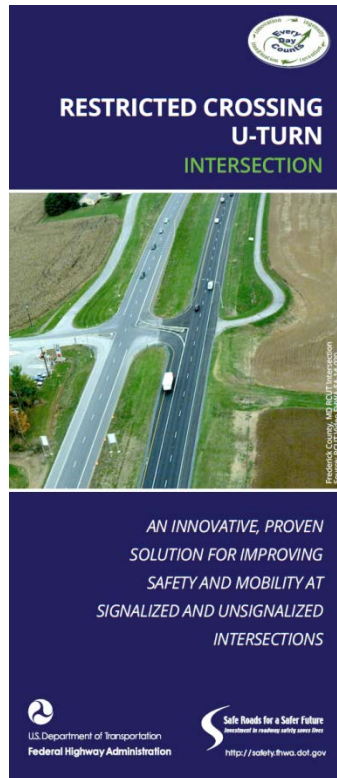

Exhibit C-2. FHWA Restricted Crossing U-Turn Intersection Brochure.

Several examples from state and local agencies are provided below, although various others are available online for additional information and guidance.

EDUCATIONAL VIDEOS

Several agencies have developed educational videos as part their outreach with RCUTs. Examples weblinks are provided below for access to these videos.

- Louisiana DOT RCUT (j-turn) Comparative Videos – There are five videos associated with this link. http://wwwsp.dotd.la.gov/Inside_LaDOTD/Pages/Videos.aspx#
- Minnesota DOT RCUT - <http://www.dot.state.mn.us/roadwork/rci.html>
- Ohio DOT RCUT (superstreet) - <http://www.dot.state.oh.us/districts/D08/Pages/SR-4-Bypass-Superstreet.aspx> and <http://www.youtube.com/watch?v=s4iFLgAzXAM>
- Texas DOT Visualization - <http://www.youtube.com/watch?v=-7PiJ0QJqMY>

BROCHURES AND FACT SHEETS

- Exhibit C-3 illustrates an informational website on RCUTs from the MnDOT.
- Exhibit C-4 illustrates a fact sheet on how to navigate a RCUT from the MnDOT.
- Exhibit C-5 illustrates page one of a two-page brochure on RCUTs from the NCDOT.
- Exhibit C-6 illustrates page one of a two-page brochure on RCUTs from the NCDOT.
- Exhibit C-7 illustrates a RCUT informational graphic from the NCDOT.
- Exhibit C-8 illustrates page one of a two-page brochure for access management elements of a RCUT project from the Louisiana DOT.
- Exhibit C-9 illustrates page two of a two-page brochure for access management elements of a RCUT project from the Louisiana DOT.
- Exhibit C-10 illustrates page one of a two-page brochure for public outreach on a RCUT project from the Louisiana DOT.
- Exhibit C-11 illustrates page two of a two-page brochure for public outreach on a RCUT project from the Louisiana DOT.
- Exhibit C-12 illustrates page one of a two-page brochure for a RCUT in Ohio.
- Exhibit C-13 illustrates page two of a two-page brochure for a RCUT in Ohio.

Reduced Conflict Intersections

Increasing safety, decreasing T-bone crashes

[Reduced Conflict Intersection Home](#) [Contacts](#)

Benefits

- Improved safety—[Studies show a 70 percent reduction in fatalities](#) and a 42 percent reduction in injury crashes where RCIs are used.
- Faster to build—RCIs can be designed and built in approximately one year. Interchanges typically take 3-5 years.
- Lower cost—RCIs are often less expensive than a stop light and are a fraction the cost of building an interchange.

Fact

A typical four-lane divided highway intersection has 42 possible vehicle conflict

Reduced Conflict Intersections

What are they?

Reduced Conflict Intersections decrease fatalities and injuries caused by broadside crashes on four-lane divided highways. These intersections have an elevated risk of severe right-angle crashes (commonly called "T-bone" crashes), especially for drivers attempting to cross all four lanes of traffic or turn left.

Why do they work?

At a traditional intersection, motorists from the side street need to look in both directions to cross a four-lane divided highway. Left turns require the same level of attention. With an RCI, drivers from the side street only have to be concerned with one direction of traffic on the highway at a time. You don't need to wait for a gap in both directions to cross a major road.

How do they work?

Motorists approaching divided highways from a side street are prohibited from making left turns or from crossing traffic; instead they are required to turn right onto the highway, then make a U-turn at a designated median opening. In an RCI, drivers always make a right turn, followed by a U-turn. This reduces potential conflict points and increases safety. Generally, the delay caused by a signal is greater



Exhibit C-3. Informational website on RCUTs from the MnDOT.



Reduced Conflict Intersections

Quicker to build, lower cost, safe solution.

Crossing a rural divided highway using a Reduced Conflict Intersection

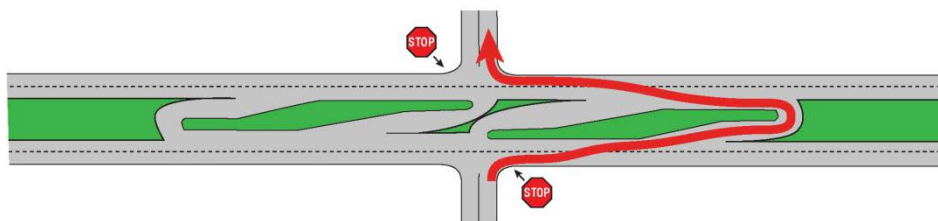

Left hand turn onto a divided highway using a Reduced Conflict Intersection

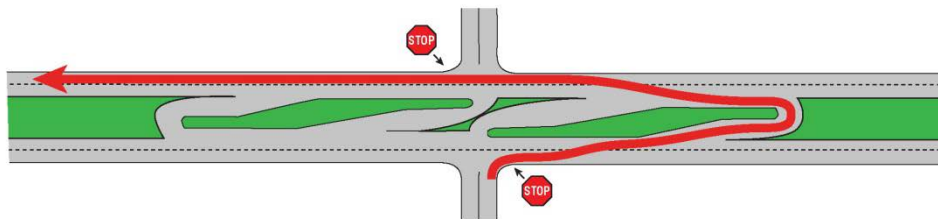

Exhibit C-4. Fact sheet on how to navigate a RCUT from the MnDOT.

Restricted Crossing U-turn Informational Guide

Conventional Intersection

The North Carolina Department of Transportation (NCDOT) is challenged to try traditional and non-traditional approaches to relieving congestion and improving safety in heavily developing areas. The superstreet is a non-traditional option the NCDOT has found beneficial. Congestion on urban and suburban arterials is an imminent consequence of developing regions of the state. Conventional intersections can create added congestion and long queues resulting in increasing delays in travel time due to the increased traffic flow.



Superstreet

A superstreet is a type of intersection in which minor cross-street traffic is prohibited from going straight through or left at a divided highway intersection. Minor cross street traffic must turn right, but can then access a u-turn to proceed in the desired direction. Other configurations of superstreets are possible based on site specific conditions.

The Superstreet concept provides an effective alternative along heavily traveled regional arterials in areas with anticipated commercial and residential growth. The design concept is contingent upon a series of features that reduce potential conflict points while maintaining traffic flow, resulting in:

- Increased safety by reducing conflict points at major crossovers
- Time savings from simplified signal phasing
- Dedicated u-turn lanes for efficiency
- An enhanced signalization operation



Left turn movement

The conventional intersection allows left turn movements from side streets creating numerous conflict point. The superstreet reduces conflict points therefore increasing safety.

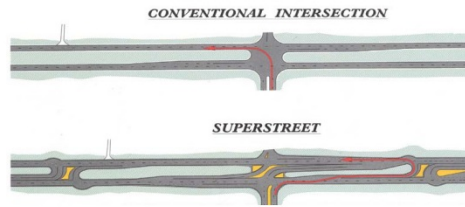

Through movement

The conventional intersection allows through movements onto side streets, creating numerous conflicts points. The superstreet intersection prohibits through movements onto side streets forcing a right turn movement onto the arterial, then a u-turn back onto the arterial to safely

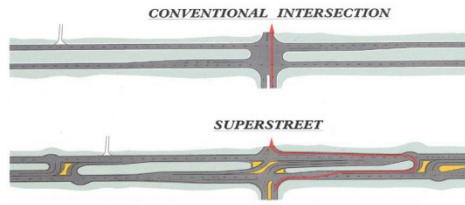

NCDOT

Superstreets

“A Tool
For
Safely
and
Efficiently
Managing
Congestion”

Exhibit C-5. Page one of a two-page brochure on RCUTs from the NCDOT.

Benefits of Superstreet

- Safety
- Time savings
- Increased capacity
- Access Management
- Improved traffic flow
- Land use and corridor protection
- Alternative to interchange (Less \$\$\$)
- Smaller “footprint” than an interchange

Strategic Highway Corridors

The superstreet alternative improves mobility as a step-by-step process by bringing us one step closer to a freeway/expressway.

The North Carolina Department of Transportation (NCDOT) in collaboration with the Department of Commerce and Department of Environment and Natural Resources has established a “vision” for 5,400 miles of highway along 55 corridors throughout the state. It’s primary purpose is “to provide a network of high-speed, safe, reliable highways throughout North Carolina.”

www.ncdot.org/nshc



For more information, please contact:
North Carolina Department of Transportation
1-800-DOT-4YOU
www.ncdot.org

North Carolina Department of Transportation

“Connecting people and places in North Carolina - safely and efficiently, with accountability and environmental sensitivity.”



SUPERSTREETS



Exhibit C-6. Page two of a two-page brochure on RCUTs from the NCDOT.



Superstreet Intersection Design

Progressive design to:

- Help improve safety
- Reduce travel time
- Reduce construction costs
- Reduce impacts on the environment

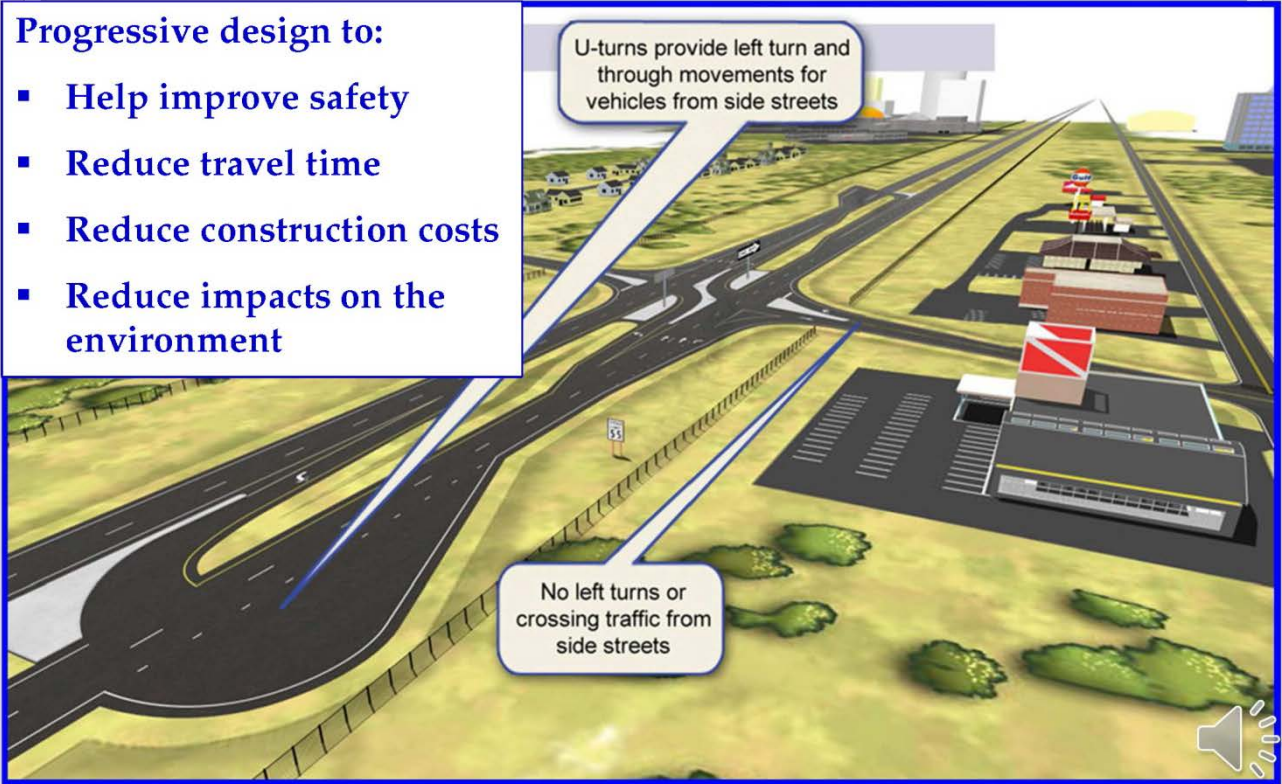

Exhibit C-7. RCUT informational graphic from the NCDOT.

Restricted Crossing U-turn Informational Guide

What is Access Management?

Access management is the careful planning of access to roadways and highways for efficiency and safety.

Think about how efficient it is to travel on an interstate with only a few access points every couple miles. This is not as efficient for a neighborhood where each house needs access to the road.

In addition, studies have shown that left turns increase opportunities for collisions, and forcing cars to make right turns then U-turns decreases collisions.

Although, ideal conditions are not always practical, we strive to make all roadways as safe and efficient as possible.

What do your customers want?

- Safe driving conditions
- Easy access to neighboring businesses
- Safe and accessible entrances and exits to your business

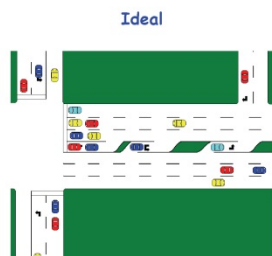

Does access management keep customers away?

No. Studies show that businesses for specific purposes such as doctors offices and specialty retail stores are unaffected by access management. Although pass-by businesses such as restaurants and gas stations may be affected by access management, studies have shown that as long as reasonable access is provided there are no negative impacts to business. In fact, a road that flows better leads to more vehicles passing by and seeing your business.



For additional information:
LA DOTD Headquarters
Traffic Engineering
(225)242-4633

District Traffic Operation Engineers
District 02 (504) 437-3105
District 03 (337) 262-6105
District 04 (318) 549-8305
District 05 (318) 342-0105
District 07 (337) 437-9105
District 08 (318) 561-5105
District 58 (318) 412-3106
District 61 (225) 389-2141
District 62 (985) 375-0105

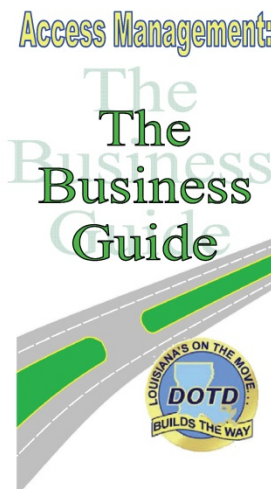
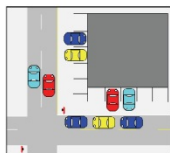

Exhibit C-8. Page one of a two-page brochure for access management elements of a RCUT project from the Louisiana DOT.

Who benefits from access management?

Everyone! Customers, employers, employees, product delivery personnel: everyone benefits from better flowing traffic and ease of access!

What happens without access management?



Many locations, like the one shown above, were once perfect for customer access. Over time, as population and traffic increase, the location becomes increasingly difficult for customers to access. Congestion makes it more difficult for your customers to enter and leave the parking spots, opening them up for new customers.

	Before	After
Parking Lot Interconnectivity	<ul style="list-style-type: none"> • No access between parking lots • No turning lane • Less traffic for each store • More access points to roadway increase congestion 	<ul style="list-style-type: none"> • Store to store access allows customers from to shop in different stores without returning to their vehicle • Protected right turn lane at entrance decreases rear end collisions for entering vehicles and provides indication of turning to exiting vehicles
Turn Lanes & Medians	<ul style="list-style-type: none"> • Uncertainty about when drivers should move into turning lane causes conflict • Drivers may not be able to turn left out of driveways due to a clogged turning lane • Drivers able to turn left from driveways must cross into at least four lanes of traffic 	<ul style="list-style-type: none"> • Designated turning lanes aids traffic flow • Changing left turn option from driveways into right turn with U-turn increases safety • Right turn driveway lane eases congestion leaving parking lot • More aesthetically appealing

What can you do to help with access management?

- Locate driveways away from intersections: Placing driveways farther from nearby intersections will decrease congestion around that driveway.
- Connect parking lots and consolidate driveways: Connected parking lots allow for customers to travel between stores without getting back on the main highway. Consolidating driveways decrease congestion on the highway and allow easier entering and exiting of parking lots.
- Coordinate new building and driveway locations with the Louisiana Department of Transportation and Development: It is in the best interest of both to reduce congestion and provide an overall safe driving experience to the community.

Exhibit C-9. Page two of a two-page brochure for access management elements of a RCUT project from the Louisiana DOT.

Restricted Crossing U-turn Informational Guide

What is Access Management?

Access management is the careful planning of access to roadways and highways for efficiency and safety.

Think about how efficient it is to travel on an interstate with only a few access points every couple miles. This is not efficient for a neighborhood where each house needs access to the road.

In addition, studies have shown that left turns increase opportunities for collisions, and forcing cars to make right turns then U-turns decreases collisions.

Although, ideal conditions are not always practical, we strive to make all roadways as safe and efficient as possible.

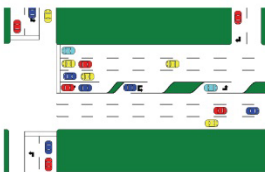

Conflict Points

Conflict points represent a place on the road where the paths of two vehicles may cross. Each time the paths of vehicles cross, an opportunity for a collision is created.

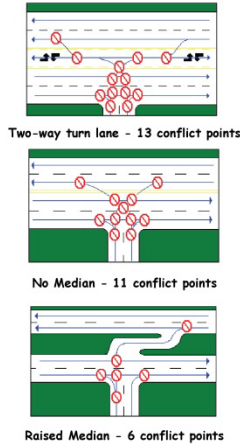

For additional information:
LA DOT Headquarters
Traffic Engineering
(225)242-4633

- District Traffic Operation Engineers
- District 02 (504) 437-3105
 - District 03 (337) 262-6105
 - District 04 (318) 549-8305
 - District 05 (318) 342-0105
 - District 07 (337) 437-9105
 - District 08 (318) 561-5105
 - District 58 (318) 412-3106
 - District 61 (225) 389-2141
 - District 62 (985) 375-0105

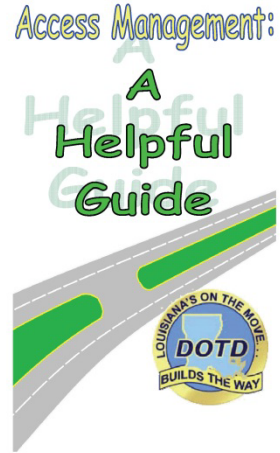
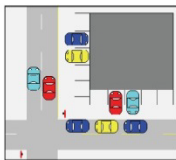

Exhibit C-10. Page one of a two-page brochure for public outreach on a RCUT project from the Louisiana DOT.

Who benefits from access management?

Everyone! Businesses, travelers, truckers, shoppers, everyone headed to and from work; everyone benefits from better flowing traffic and ease of access!

What happens without access management?



Many locations, like the one shown above, were once perfect for vehicle access. Over time, as population and traffic increase, the location becomes increasingly difficult to access. Congestion makes it more difficult to enter and leave the parking spots and merge onto the road.

Parking Lot Interconnectivity

Before

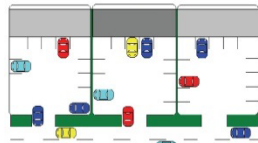

- No access between parking lots
- Many driveways congesting highway
- 27 conflict points

After

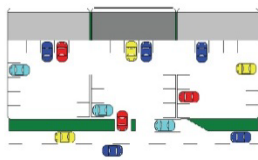

- Store to store access
- Protected right turn lane at entrance decreases conflict points
- Consolidated driveways and parking lot interconnectivity reduce conflict points
- 8 conflict points

Turn Lanes & Medians

Before

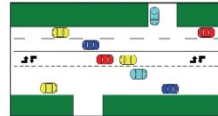

- Uncertainty about when drivers should move into turning lane causes conflict
- Turning lane clogged with opposing vehicles
- Drivers turning left from driveways must watch at least four lanes of traffic
- Use of turn lane as an acceleration lane for entering traffic
- 26 conflict points

After

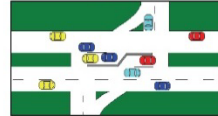

- Designated turning lanes reduce conflict points
- Changing left turn option from driveways into right turn with U-turn reduces conflict points
- 16 conflict points

Roundabouts

Before



- Drivers must slow down generously to turn
- Traffic must stop in one direction
- Turning vehicles may halt through traffic
- 7 conflict points

After

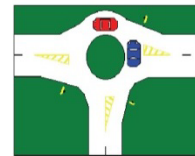

- No stop required when roundabout is available, reducing traffic
- Yield signs make all drivers cautious and safe
- Island allows for scenic additions
- Naturally slower speeds

Exhibit C-11. Page two of a two-page brochure for public outreach on a RCUT project from the Louisiana DOT.

Fact Sheet: SUPERSTREETS

What?

A Superstreet is a type of intersection designed to provide efficient traffic operation within limited right of way.

Why?

- A conventional intersection design will not be able to handle future traffic.
- The superstreet design allows efficient movement of traffic, reducing delay by up to 90% compared to a conventional intersection.
- An interchange design would have required significantly more time, land, and money to construct.
- A superstreet contains fewer conflict points than a conventional intersection, reducing the number of crashes that could occur.

How?

- SR 4 Bypass: operation is not changed.
- Side Streets: all traffic must turn right at the intersection, as shown in the diagram.

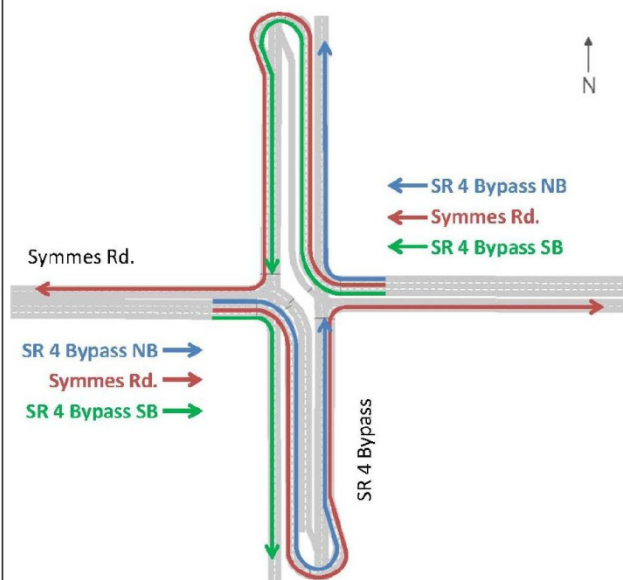

When?

Construction begins on the corridor in the spring of 2010 and is expected to be complete by the spring of 2012, with the first superstreet at SR 4 Bypass & Hamilton Mason Road beginning operation as early as 2011.

Where?

- SR 4 Bypass & Symmes Road
- SR 4 Bypass & Tylersville Road
- SR 4 Bypass & Hamilton Mason Road
- This corridor will be the first in Ohio, but they currently are in place in various states such as North Carolina and Maryland.

View a simulation on the ODOT website: <http://www.dot.state.oh.us/districts/d08/Pages/default.aspx>



OHIO DEPARTMENT OF
TRANSPORTATION

Exhibit C-12. Page one of a two-page brochure for a RCUT in Ohio.



Exhibit C-13. Page two of a two-page brochure for a RCUT in Ohio.

This page intentionally left blank.



Safe Roads for a Safer Future
Investment in roadway safety saves lives

safety.fhwa.dot.gov
Publication Number FHWA-SA-14-070