

Signalized Intersections Informational Guide

Second Edition



FHWA Safety Program



U.S. Department of Transportation
Federal Highway Administration



<http://safety.fhwa.dot.gov>

Signalized Intersections

Informational Guide

Second Edition

Publication No. FHWA-SA-13-027

July 2013



U.S. Department of Transportation
Federal Highway Administration



<http://safety.fhwa.dot.gov>

FOREWORD

This report, now in its Second Edition, complements the American Association of State Highway and Transportation Officials (AASHTO) Strategic Highway Safety Plan (SHSP) efforts to develop guidance on enhancing the safety of unsignalized and signalized intersections. The overarching goal is to reduce the number of traffic related deaths that occur on highways and streets in the United States. This guide is an introductory document that contains methods for evaluating the safety and operations of signalized intersections and tools to remedy deficiencies. The treatments in this guide range from low-cost measures such as improvements to signal timing or signing and markings, to high-cost measures such as intersection widening or reconstruction. Topics covered include fundamental principles of user needs and human factors, multimodal accommodations (emphasizing pedestrians and bicyclists), elements of geometric design, and traffic safety design and operation; safety, maintenance and operations practices; and a wide variety of treatments, techniques and strategies to address existing or anticipated problems at multiple levels, including corridor, approach and individual movement treatments. Each recommended treatment includes a discussion of safety performance, operations, multimodal issues, and physical and economic factors that the practitioner should consider. While some treatments may be better suited to high-volume intersections, most of the treatments are applicable for lower volume intersections and would be worthy of systemic implementation. Every attempt has been made to reflect the latest research and documentation on available treatments and best practices in use by jurisdictions across the United States at the time of publication. Since the scope of this guide is necessarily limited, additional resources and references are highlighted for the student, practitioner, researcher, or decision maker who endeavors to learn more about a particular subject.

An electronic version of this document can be downloaded from the Federal Highway Administration, Office of Safety website at <http://safety.fhwa.dot.gov/>. A hard copy may be requested by contacting the National Highway Institute, 1310 North Courthouse Road, Suite 300, Arlington, VA 22201; telephone (703) 235-0500; fax (703) 235-0593.



Michael Griffith
Director
Office of Safety Technologies

NOTICE

This document is disseminated under the sponsorship of the U.S. Department of Transportation in the interest of information exchange. The U.S. Government assumes no liability for the use of the information contained in this document.

The U.S. Government does not endorse products or manufacturers. Trademarks or manufacturers' names appear in this report only because they are considered essential to the objective of the document.

QUALITY ASSURANCE STATEMENT

The Federal Highway Administration (FHWA) provides high-quality information to serve Government, industry, and the public in a manner that promotes public understanding. Standards and policies are used to ensure and maximize the quality, objectivity, utility, and integrity of its information. FHWA periodically reviews quality issues and adjusts its programs and processes to ensure continuous quality improvement.

Technical Report Documentation Page

1. Report No. FHWA-SA-13-027	2. Government Accession No.	3. Recipient's Catalog No.	
4. Title and Subtitle Signalized Intersections Informational Guide, Second Edition		5. Report Date July 2013	
		6. Performing Organization Code	
7. Author(s) Principal Investigator: Brian E. Chandler Co-Authors: Matthew C. Myers, Jennifer E. Atkinson, Thomas E. Bryer, Richard Retting, Jeff Smithline, Jeff Trim, Peter Wojtkiewicz, Gary B. Thomas, Steven P. Venglar, Srinivasa Sunkari, Brian J. Malone, and Pedram Izadpanah.		8. Performing Organization Report No.	
9. Performing Organization Name and Address SAIC 11251 Roger Bacon Drive Reston, VA 20190 Subconsultants: CIMA+, Sam Schwartz Engineering, Texas A&M Transportation Institute		10. Work Unit No. (TRAIS)	
		11. Contract or Grant No. Contract No. DTFH61-10-D-00024, Task Order No. T-11-006	
12. Sponsoring Agency Name and Address Federal Highway Administration Office of Safety 1200 New Jersey Avenue SE Washington, DC 20590		13. Type of Report and Period Covered Informational Guide Book August 2011 to July 2013	
		14. Sponsoring Agency Code FHWA HSA	
15. Supplementary Notes Jeffrey Shaw (jeffrey.shaw@dot.gov), Office of Safety Technologies (http://safety.fhwa.dot.gov/), served as the Technical Manager for the Federal Highway Administration (FHWA). The following FHWA staff members contributed as technical working group members, reviewers and/or provided input or feedback to the project at various stages: Timothy Taylor, Bruce Friedman, Tom Elliott, Jim Sturrock, Paul Olson, Mark Doctor, John Broemmelsiek, Joe Bared, James Coylar, Jim McCarthy, Eddie Curtis, Joe Glinski, Ed Rice (retired), Scott Wainwright (retired), Carol Tan, Caroline Trueman and Don Petersen. Additionally, many individual safety partners representing federal, state and local agencies, professional associations, academia and industry, made significant contributions to this project; special thanks to Tom Hicks (retired – Maryland SHA), Mark Hagan (Virginia DOT), Julie Stotlemeyer (Missouri DOT), Jake Kononov (retired – Colorado DOT), Dwight Kingsbury (Florida DOT), Julie Bradley (Pennsylvania DOT), Jim Ellison (retired – Pierce County, WA), Peter Koonce (City of Portland, OR), Dr. Praveen Edara (University of Missouri), Doug Noble (Institute of Transportation Engineers), Melissa Anderson (U.S. Access Board), and Fred Ranck (traffic safety consultant).			
16. Abstract This is the Second Edition of a document that was originally published in 2004. This document serves as an introduction to and guide for evaluating the safety, design, and operations of signalized intersections. It also provides tools to deliver better balanced solutions for all users. It takes a holistic approach to signalized intersections and considers the safety and operational implications of a particular treatment on all system users (e.g., motorists, pedestrians, bicyclists, and transit users). Readers will find the tools and information necessary to make insightful intersection assessments and to understand the impacts of potential improvement measures. The information in this guide is based on the latest research available and includes examples of novel treatments as well as best practices in use by jurisdictions across the United States and other countries.			
17. Key Words Signalized Intersections, Intersection Safety, Intersection Design, Intersection Performance, Intersection Treatments		18. Distribution Statement No restrictions	
19. Security Classif. (of this report) Unclassified	20. Security Classif. (of this page) Unclassified	21. No. of Pages 323	22. Price N/A

SI* (MODERN METRIC) CONVERSION				
FACTORS APPROXIMATE CONVERSIONS TO SI UNITS				
SYMBOL	WHEN YOU KNOW	MULTIPLY BY	TO FIND	SYMBOL
LENGTH				
in	inches	25.4	millimeters	mm
ft	feet	0.305	meters	m
yd	yards	0.914	meters	m
mi	miles	1.61	kilometers	km
AREA				
in ²	square inches	645.2	square millimeters	mm ²
ft ²	square feet	0.093	square meters	m ²
yd ²	square yard	0.836	square meters	m ²
ac	acres	0.405	hectares	ha
mi ²	square miles	2.59	square kilometers	km ²
VOLUME				
fl oz	fluid ounces	29.57	milliliters	mL
gal	gallons	3.785	liters	L
ft ³	cubic feet	0.028	cubic meters	m ³
yd ³	cubic yards	0.765	cubic meters	m ³
NOTE: volumes greater than 1000 L shall be shown in m ³				
MASS				
oz	ounces	28.35	grams	g
lb	pounds	0.454	kilograms	kg
T	short tons (2000 lb)	0.907	megagrams (or "metric ton")	Mg (or "t")
TEMPERATURE (exact degrees)				
°F	Fahrenheit	5 (F-32)/9 or (F-32)/1.8	Celsius	°C
ILLUMINATION				
fc	foot-candles	10.76	lux	lx
fl	foot-Lamberts	3.426	candela/m ²	cd/m ²
FORCE and PRESSURE or STRESS				
lbf	poundforce	4.45	newtons	N
lbf/in ²	poundforce per square inch	6.89	kilopascals	kPa
APPROXIMATE CONVERSIONS FROM SI UNITS				
SYMBOL	WHEN YOU KNOW	MULTIPLY BY	TO FIND	SYMBOL
LENGTH				
mm	millimeters	0.039	inches	in
m	meters	3.28	feet	ft
m	meters	1.09	yards	yd
km	kilometers	0.621	miles	mi
AREA				
mm ²	square millimeters	0.0016	square inches	in ²
m ²	square meters	10.764	square feet	ft ²
m ²	square meters	1.195	square yards	yd ²
ha	hectares	2.47	acres	ac
km ²	square kilometers	0.386	square miles	mi ²
VOLUME				
mL	milliliters	0.034	fluid ounces	fl oz
L	liters	0.264	gallons	gal
m ³	cubic meters	35.314	cubic feet	ft ³
m ³	cubic meters	1.307	cubic yards	yd ³
MASS				
g	grams	0.035	ounces	oz
kg	kilograms	2.202	pounds	lb
Mg (or "t")	megagrams (or "metric ton")	1.103	short tons (2000 lb)	T
TEMPERATURE (exact degrees)				
°C	Celsius	1.8C+32	Fahrenheit	°F
ILLUMINATION				
lx	lux	0.0929	foot-candles	fc
cd/m ²	candela/m ²	0.2919	foot-Lamberts	fl
FORCE and PRESSURE or STRESS				
N	newtons	0.225	poundforce	lbf
kPa	kilopascals	0.145	poundforce per square inch	lbf/in ²

*SI is the symbol for the International System of Units. Appropriate rounding should be made to comply with Section 4 of ASTM E380.

Table of Contents

1.0	INTRODUCTION	1-2
1.1	Background	1-2
1.2	Performance Measurement and Asset Management	1-6
1.3	Scope of the Guide	1-7
1.4	Audience for this Guide	1-7
1.5	Organization of the Guide	1-7
2.0	HUMAN FACTORS.....	2-2
2.1	Overview of Human Factors	2-2
2.2	Intersection Users.....	2-5
2.3	Applying Human Factors	2-22
3.0	DATA COLLECTION AND WARRANTS	3-1
3.1	Commitment.....	3-2
3.2	Where Do You Start? Importance of an Engineering Analysis and Study.....	3-2
3.3	Intersection Data Collection Needed.....	3-2
3.4	Intersection Counts.....	3-2
3.5	Traffic Signal Warrants.....	3-6
3.6	When is Not Signalizing an Intersection the Right Decision?	3-9
4.0	GEOMETRIC DESIGN.....	4-3
4.1	Number of Intersection Legs	4-4
4.2	Channelization	4-5
4.3	Horizontal and Vertical Alignment	4-10
4.4	Corner Radius	4-12
4.5	Sight Distance	4-14
4.6	Pedestrian Treatments	4-16
4.7	Bicycle Facilities.....	4-20
4.8	Transit Facilities.....	4-22
5.0	TRAFFIC DESIGN AND ILLUMINATION.....	5-3
5.1	Traffic Signal Phasing.....	5-3
5.2	Vehicle and Pedestrian Displays	5-13
5.3	Traffic Signal Pole Layout.....	5-20
5.4	Traffic Signal Controller and Cabinet.....	5-21
5.5	Detection Devices	5-22
5.6	Traffic Signal Control Type	5-25
5.7	Basic Signal Timing Parameters	5-25
5.8	Signing and Pavement Marking Design	5-31
5.9	Illumination Design.....	5-34
6.0	SAFETY ANALYSIS METHODS	6-3
6.1	Qualitative Approach	6-4
6.2	Quantitative Approach	6-6
6.3	Network Screening or Selection of an Intersection.....	6-6
6.4	Diagnosis.....	6-14
6.5	Selecting Countermeasures	6-27
6.6	Economic Appraisal	6-32
6.7	Project Prioritization	6-35
6.8	Safety Effectiveness Evaluation.....	6-37
7.0	OPERATIONAL ANALYSIS METHODS	7-2
7.1	Operational Performance Measures	7-5
7.2	Traffic Operations Elements	7-11
7.3	General Considerations Sizing an Intersection.....	7-13

7.4	Critical Lane Analysis.....	7-14
7.5	HCM Operational Procedure for Signalized Intersections.....	7-17
7.6	Arterial and Network Signal Timing Models.....	7-18
7.7	Microscopic Simulation Models.....	7-19
7.8	Operational Performance Model Selection.....	7-20
8.0	SYSTEM-WIDE TREATMENTS.....	8-3
8.1	Median Treatments.....	8-3
8.2	Access Management.....	8-13
8.3	Signal Coordination.....	8-22
8.4	Signal Preemption and/or Priority.....	8-25
9.0	INTERSECTION-WIDE TREATMENTS.....	9-3
9.1	Pedestrian Treatments.....	9-3
9.2	Bicycle Treatments.....	9-18
9.3	Transit Treatments.....	9-21
9.4	Traffic Control Treatments.....	9-23
9.5	Street Lighting and Illumination.....	9-32
9.6	Remove Traffic Signal.....	9-35
10.0	APPROACH TREATMENTS.....	10-2
10.1	Signal Head Placement and Visibility.....	10-2
10.2	Signing and Speed Control Treatments.....	10-12
10.3	Roadway Surface Improvements.....	10-14
10.4	Sight Distance Treatments.....	10-20
10.5	Dilemma Zone Detection.....	10-23
10.6	Red Light Camera Enforcement.....	10-25
11.0	INDIVIDUAL MOVEMENT TREATMENTS.....	11-3
11.1	Left-Turn Treatments.....	11-3
11.2	Right-Turn Treatments.....	11-18
11.3	Variable Lane Use Treatments.....	11-36
	List of Acronyms.....	A-1
	Glossary of Terms.....	G-1
	References.....	R-1

CHAPTER 1

INTRODUCTION

TABLE OF CONTENTS

1.0	INTRODUCTION	1-2
1.1	Background	1-2
1.2	Performance Measurement and Asset Management	1-6
1.3	Scope of the Guide	1-7
1.4	Audience for this Guide.....	1-7
1.5	Organization of the Guide	1-7

LIST OF EXHIBITS

1-1	Summary of motor vehicle crashes related to junction and severity in the United States during 2009.....	1-4
1-2	Vehicle detection by inductive loop (left) and video (right)	1-5
1-3	Inside a signal controller cabinet	1-5
1-4	Signalized intersection with four approaches	1-7
1-5	Organization of the guide.....	1-8
1-6	List of intersection treatments discussed in this guide.	1-9

References to be used throughout the Guide include:

- TRB *Highway Capacity Manual* (2010)
- FHWA *Manual on Uniform Traffic Control Devices* (2009)
- AASHTO *A Policy on Geometric Design of Highways and Streets* (2011)
- AASHTO *Highway Safety Manual* (2010)
- TRB NCHRP Report 500 series
- FHWA *Alternative Intersections and Interchanges Informational Report* (2010)
- U.S. Access Board *Draft Public Rights-of-Way Accessibility Guidelines* (2011)
- U.S. Access Board *ADAAG Requirements for Detectable Warnings* (2008)
- U.S. Access Board *ADA Standards for Accessible Design* (2010)
- FHWA *Traffic Signal Timing Manual* (2008)
- FHWA *Traffic Detector Handbook* (2006)
- ITE *Traffic Control Devices Handbook* (2011)
- IESNA *American National Standard Practice for Roadway Lighting* (2005)

1.0 INTRODUCTION

This document serves as an introduction to and guide for evaluating the safety, design, and operations of signalized intersections. It also provides tools to deliver better balanced solutions for all users. The treatments in this guide range from low-cost measures such as improvements to signal timing and signing, to high-cost measures such as intersection reconstruction or grade separation. While some treatments apply only to higher volume intersections, much of this guide is applicable to signalized intersections of all volume levels.

The guide takes a holistic approach to signalized intersections and considers the safety and operational implications of a particular treatment on all system users (e.g., motorists, pedestrians, bicyclists, and transit users). When applying operational or safety treatments, it is often necessary to consider the impact one will have on the other. This guide will introduce the user to these trade-offs and their respective considerations.

Practitioners will find the tools and information necessary to make insightful intersection assessments and to understand the impacts of potential improvement measures. The information in this guide is based on the latest research available and includes examples of novel treatments as well as best practices in use by jurisdictions across the United States and other countries. Additional resources and references are mentioned for the practitioner who wishes to learn more about a particular subject.

This guide does not replicate or replace traditional traffic engineering documents such as the *Manual on Uniform Traffic Control Devices* (MUTCD),⁽¹⁾ the *Highway Capacity Manual* (HCM) 2010⁽²⁾ or the American Association of State Highway and Transportation Officials' (AASHTO) *A Policy on Geometric Design of Highways and Streets*,⁽³⁾ nor is it intended to serve as a standard or policy document. Rather, it provides a synthesis of best practices and treatments intended to help practitioners make informed, thoughtful decisions.

1.1 BACKGROUND

Traffic Signal Basics

Traffic signals are electrically operated traffic control devices that provide indication for roadway users to advance their travels by assigning right-of-way to each approach and movement. Traffic signals are a common form of traffic control used by State and local agencies to address roadway operations and safety issues. They allow the shared use of road space by separating conflicting movements in time and allocating delay, and can be used to enhance the mobility and safety of some movements.

Consider the installation of traffic signals when attempting to obtain any of the following:

- Optimization of travel delay
- Reduction of crash frequency and/or severity
- Prioritization of specific roadway user type or movement (such as pedestrians or left turn movements)
- Accommodation of a new intersection approach or increase in traffic volumes (such as the addition of an approach at a new development)

Analysis of traffic volume data, crash history, roadway geometry, and other field conditions are the determining factors when deciding upon the installation of traffic signals. Planners, designers, and traffic engineers work together to determine if conditions are right for installation. Several safety and mobility factors should be considered as new traffic signal installation is being discussed. Chapter 4C of the MUTCD outlines basic warrants for when installation of a traffic signal may be justified. In addition to the considerations presented in the MUTCD, practitioners should give thought to roadway/intersection geometry and sight distance, driver expectancy, and the locations of other nearby traffic signals when considering the installation of new traffic signals.

When weighing the options for traffic control types at an intersection, consider the following important factors:

- The design and operation of traffic signals will require choosing elements that may lead to trade-offs in safety and mobility.
- It is possible to lower the overall crash severity at intersections with traffic signals, but increase the crash frequency. Table 14-7 of the 2010 Highway Safety Manual illustrates the effects of converting a stop controlled intersection to a signalized intersection.
- There will be ongoing operational costs attributed to the maintenance of signal equipment and costs for electrical power.

Once installed, the traffic engineers and field traffic signal technicians who operate and maintain the traffic signals should regularly perform site visits to:

- Ensure that safety and mobility targets for the intersection are being met, and make adjustments to signal timings, if necessary, to meet the targets;
- Inspect corresponding intersection signing and pavement markings to ensure they properly convey the intended instructions to roadway users;
- Log site visit findings for use when making adjustments or recommendations for change; and
- Communicate traffic signal maintenance and repair needs to field technicians.

Ideally, field traffic signal technicians are qualified to perform maintenance inspections at regular intervals. Repairs are made such that the signal operates safely and efficiently at all times. Technicians are also responsible for the general upkeep and operation of signal equipment located at the intersection.

An agency will identify that a traffic signal needs upgrades, replacement or decommission at some point during its life. Degradation of equipment, new technology, or changing conditions at the site, such as lane additions or the need for alternate phasing, may necessitate an upgrade or full replacement. In some instances, the traffic signal may be completely removed if traffic patterns cease to warrant its use.

Traffic Operations: Safety and Mobility

Traffic signals play a prominent role in achieving safer performance at intersections. Research has shown that the proper installation and operation of traffic signals can reduce the severity of crashes. However, unnecessary or inappropriately designed signals can adversely affect traffic, safety, and mobility. Care in their placement, design, and operation is essential.

In some cases, the dual objectives of mobility and safety will conflict. To meet increasing and changing demands, one element may need to be sacrificed to achieve improvements in the other. In all cases, it is important to understand the degree to which traffic signals are providing mobility and safety for all roadway users.

Assuring the efficient operation of the traffic signal is becoming an increasingly important issue as agencies attempt to maximize vehicle roadway capacity to serve the growing demand for travel, while maintaining a high level of safety.

Reducing crashes should always be one of the objectives whenever the design or operational characteristics of a signalized intersection are modified. As described by the Federal Highway Administration (FHWA), the “mission is not simply to improve mobility and productivity, but to ensure that improved mobility and productivity come with improved safety.”⁽⁴⁾

Exhibit 1-1 shows that in 2009, 21 percent of all crashes and 24 percent of all fatalities and injury collisions occurred at signalized intersections.

Exhibit 1-1. Summary of motor vehicle crashes related to junction and severity in the United States during 2009.

	Total Crashes		Fatalities/Injuries	
	<i>Number</i>	<i>Percent</i>	<i>Number</i>	<i>Percent</i>
Non-Intersection Crashes	3,295,000	60	841,027	54
Signalized Intersection Crashes	1,158,000	21	372,299	24
Non-Signalized Intersection Crashes	1,052,000	19	332,471	22
Total	5,505,000	100	1,547,797	100

Source: Adapted from table 29 of *Traffic Safety Facts 2009*.⁽⁵⁾

How a Traffic Signal Works

Traffic signals are designed to allow for the safe and efficient passage of road users when demand exists. Types of traffic signal operation include pre-timed, semi-actuated, fully-actuated, hybrid, adaptive, or traffic responsive. Pre-timed signals give right-of-way to movements based on a predetermined allocation of time. Semi-actuated signals use various detection methods to identify roadway users on the minor approaches, while fully-actuated signals recognize users on all approaches. Chapter 5 discusses each of these methods in further detail.

In addition to the signal heads seen by the road users, signalized intersections may include additional components, such as loop detectors and video detection equipment. The following paragraphs provide information related to each component.



Exhibit 1-2. Vehicle detection by inductive loop (left) and video (right)
(Source: Left: South Carolina DOT / Right: Jeff Shaw, FHWA)

Detection.

Semi- and fully actuated signals use various methods to detect road users. Detection methods for motorists include in-pavement loop detectors or sensors (Exhibit 1-2 (left)) and cameras mounted to signal poles (Exhibit 1-2 (right)). Detection methods for pedestrians and bicyclists include push buttons and weight sensors.

Traffic signal controller.

Each detection method sends vehicle presence information to a traffic signal controller. The controller acts as the “brain” of the traffic signal, changing signal indications based on programmed instructions. The controller will determine when the indication for the approach will change and how much time will be given to each movement. A controller is shown in Exhibit 1-3.

Traffic control algorithms determine the priority and length of time of each approach movement. These algorithms are tailored to the needs of each intersection, based on historical user demand, crash history, and other roadway network considerations.

Signal heads.

Traffic signal heads inform roadway users of when their movement can proceed through the intersection. Signal heads for motorists and bicyclists are usually mounted on mast arms or span wires above the travel lane, and are sometimes repeated on the signal pole. Pedestrian signal heads are often installed on the traffic signal pole, or independently on separate poles depending on the intersection design. Signal heads vary in configuration, shape, and size depending on the movement for which they are used.



Exhibit 1-3. Inside a signal controller cabinet.
Photo Credit: Missouri DOT

Types of Signalized Intersections

In their most common form, signalized intersections have indications for users on each intersection approach. Exhibit 1-4, below, shows a basic signalized intersection with four vehicle approaches and two pedestrian approaches.

In addition to signaling intersections, it may be necessary to consider the use of pedestrian signals at locations along a corridor with high concentrations of pedestrians. This type of traffic control can be used at signalized intersections with the addition of pedestrian push-buttons and signal heads, or at non-signalized locations that have high volumes of pedestrians crossing. This guide also provides direction on the use of treatments such as the Pedestrian Hybrid Beacon. Pedestrian signals are discussed in more detail in Chapter 5.

1.2 PERFORMANCE MEASUREMENT AND ASSET MANAGEMENT

Agencies face the challenge of providing outstanding customer service with limited resources. Performance measures allow practitioners to assess the effectiveness of a signalized intersection or corridor. These measures can help agencies more effectively allocate resources. Travel performance criteria include: stopped delay, travel speed, arrivals on red, and excessive queuing. Safety performance criteria include crash frequency, crash types, and severity. Traffic signal maintenance data could be categorized according to time of day or types of repair. Over time, practitioners and agencies can refine or adjust these measures.

The practitioner should review this data to assess problem areas to correct. Other information that may be needed includes comments from the practitioner's annual signal timing reviews and annual preventive maintenance program. Examples of questions that may arise from such a review:

- What intersections require monthly visits to fix?
- What types of repetitive repairs are being conducted over a wide number of intersections?
- Are phasing (or other) changes necessary to reduce the number of crashes?

Practitioners should create queries that identify problematic intersections. These queries can also identify global intersection treatments that reduce systematic problems. For example, an agency could choose to install uninterrupted power supply (UPS) units for frequent power outages. The following information can be utilized to monitor performance:

- Detection failures by type of device.
- Outages due to power surges and outages.
- Customer complaints and complements.
- Emergency personnel comments.
- Frequent equipment hits by errant vehicles.
- Damage by weather events.
- Intermittent issues.
- Number of red failures.

Reviews of these measures should involve traffic engineers, technicians, and operations personnel to create a culture of continuous improvement.

1.3 SCOPE OF THE GUIDE

This guide addresses safety and operation for all users of signalized intersections, including motorists, pedestrians, bicyclists, and transit riders. This guide addresses Americans with Disabilities Act (ADA) requirements and provides guidelines for considering older drivers.

Roundabouts and other alternative intersection designs are not addressed directly in this document; for more information, please refer to *Roundabouts: An Informational Guide, Second Edition* ⁽⁶⁾ and the FHWA *Alternative Intersections/Interchanges Informational Report*. ⁽⁵⁵⁾

1.4 AUDIENCE FOR THIS GUIDE

This guide is intended for planners, designers, traffic engineers, operations analysts, and signal technicians who perform or want to perform one or more of the following functions as they pertain to signalized intersections:

- Evaluate substantive safety performance experienced by system users.
- Evaluate operational performance experienced by system users.
- Identify treatments that could address a particular operational or safety deficiency.
- Understand fundamental user needs, geometric design elements, or signal timing and traffic design elements.
- Understand the impacts and tradeoffs of a particular intersection treatment.

It is envisioned that this guide will be used by signal technicians, design and traffic engineers, planners, and decision-makers who:

- Wish to be introduced to basic and intermediate traffic signal concepts.
- Are involved with the planning, design, and operation of signalized intersections, particularly those with high volumes.
- Are involved with the identification of potential treatments.
- Make decisions regarding the implementation of treatments at those intersections.

1.5 ORGANIZATION OF THE GUIDE

This guide is arranged in three parts:

- Part I: Fundamentals.
- Part II: Project Process and Analysis Methods.
- Part III: Treatments.

Part I (Chapters 2-5) provides key background information on three topic areas: user needs, data collection, signal warrants, geometric design, and traffic design and illumination. These chapters provide a foundation of knowledge of signalized intersections useful as a learning tool for entry-level engineers and as a refresher for more experienced engineers. Parts II and III reference the information in these chapters.

Part II (Chapters 6-7) describes project process and analysis methods. These chapters outline the steps that should be carried out and the tools to consider for evaluating the safety and operational performance of an intersection and determining geometric and timing needs.



Exhibit 1-4. Signalized intersection with four approaches.

Source: FHWA

Part III (Chapters 8-11) provides a description of treatments that can be applied to mitigate a known safety or operational deficiency. The treatments are organized by chapter, based on the intersection element. Within each chapter, the treatments are grouped by a particular user type (e.g., pedestrian treatments) or are grouped to reflect a particular condition (e.g., signal head visibility).

Exhibit 1-5 depicts the organization of the guide.

Exhibit 1-5. Organization of the guide.

Part	Chapter	Title
	1	Introduction
Part I: Fundamentals	2	User Needs
	3	Data Collection and Warrants
	4	Geometric Design
	5	Traffic Design and Illumination
Part II: Project Process and Analysis Methods	6	Safety Analysis Methods
	7	Operational Analysis Methods
Part III: Treatments	8	System-Wide Treatments
	9	Intersection-Wide Treatments
	10	Approach Treatments
	11	Individual Movement Treatments

Exhibit 1-6 provides a list of the treatments discussed in Part III. Each treatment includes a description, a photo or diagram where available, and a summary of the treatment's applicability. In addition, these sections identify the following:

- Key design elements;
- Operational and safety impacts;
- Impacts on other modes;
- Socioeconomic and physical impacts; and
- Education, enforcement, and maintenance issues.

The treatments in Exhibit 1-6 represent some, but not all, possible treatments.

Exhibit 1-6. List of intersection treatments discussed in this guide.

Treatment Type	Treatments	
System-Wide Treatments (Chapter 8)	<ul style="list-style-type: none"> • Median treatments • Access management 	<ul style="list-style-type: none"> • Provide signal coordination • Provide signal preemption/priority
Intersection-Wide Treatments (Chapter 9)	<ul style="list-style-type: none"> • Reduce curb radius • Provide curb extensions • Modify stop line location • Improve pedestrian signal display • Modify pedestrian signal phasing • Grade separate pedestrian movements • High visibility crosswalks 	<ul style="list-style-type: none"> • Provide bicycle box (experimental) • Provide bike lanes • Relocate transit stop • Change signal control from pre-timed to actuated • Modify change and clearance intervals • Modify cycle length • Remove late night/early morning flash • Provide or upgrade illumination • Convert signalized intersection to a roundabout or all-way stop control.
Approach Treatments (Chapter 10)	<ul style="list-style-type: none"> • Convert to over-the-road signal heads • Add supplemental signal heads • Increase size of signal heads • Increase number of signal heads • Provide backplates 	<ul style="list-style-type: none"> • Provide advance warning • Improve lane use and street name signing • Reduce operating speed • Improve pavement surface • Improve cross section • Remove obstacles from clear zone • Improve sight lines • Provide dilemma zone protection • Provide red light camera enforcement
Individual Movement Treatments (Chapter 11)	<ul style="list-style-type: none"> • Add single left-turn lane • Add multiple left-turn lane • Add channelizing islands • Add single right-turn lane • Provide double right-turn lanes 	<ul style="list-style-type: none"> • Restrict turns, U-turns • Provide auxiliary through lane • Delineate through path • Provide reversible lane • Provide variable lane use assignments

Part I

Fundamentals

Part I discusses the fundamentals of signalized intersections as they relate to Human Factors (Chapter 2), Data Collection and Warrants (Chapter 3), Geometric Design (Chapter 4), and Traffic Signal Design and Illumination (Chapter 5). These chapters are intended for use by entry-level engineers and other users of the guide who seek broad-level information on the technical aspects of signalized intersections. The information provides a background for the chapters in Part II and Part III.

CHAPTER 2

Human Factors

TABLE OF CONTENTS

2.0	HUMAN FACTORS.....	2-2
2.1	Overview of Human Factors	2-2
2.1.1	Positive Guidance	2-4
2.1.2	Roadway Safety Fundamentals	2-4
2.2	Intersection Users	2-5
2.2.1	Human Factors Common to All Road Users.....	2-5
2.2.2	Motorists.....	2-9
2.2.3	Bicyclists	2-13
2.2.4	Pedestrians	2-17
2.3	Applying Human Factors.....	2-22

LIST OF EXHIBITS

2-1	Signs confused with background information.....	2-6
2-2	Example of sign clutter.....	2-6
2-3	Fatal two-vehicle intersection crashes by traffic control device and driver age	2-8
2-4	Estimated number of registered vehicles by type, 2010.....	2-10
2-5	Fatalities by mode, 2009.....	2-11
2-6	Injuries by mode, 2009	2-11
2-7	Proportion of crashes by collision type at signalized intersections.....	2-11
2-8	Enforcement cameras, as shown in the photo above, are used at signalized intersections to identify red light runners	2-12
2-9	Typical dimensions of a bicyclist.....	2-15
2-10	Bicyclist conflicts at signalized intersections	2-17
2-11	Examples of pedestrians of various abilities preparing to cross an intersection	2-18
2-12	Typical dimensions for a sample of types of pedestrians.....	2-19
2-13	Typical dimensions for a turning wheelchair.....	2-19
2-14	Crosswalks are used by a variety of users with different speed characteristics	2-20
2-15	Pedestrian conflicts at signalized intersections	2-21

2.0 HUMAN FACTORS

This chapter describes road user needs at and around signalized intersections. The description is based on three assumptions:

- Practitioners should adopt an integrated, systems view founded on human factors principles of the interactions among intersection design, traffic control, environmental factors, and road users.
- The road user—motorist, bicyclist, and pedestrian—is the operative element in the system; decisions affecting user performance taken at any point in the roadway life cycle often involve tradeoffs involving one or more road user types.
- Practitioners need to fully understand and quantify intersection operations and safety performance in the pursuit of informed and balanced decision-making.

A discussion of user needs requires an understanding of human factors principles for all intersection users. This chapter provides an introduction to human factors research, followed by a description of user needs for motorists, pedestrians, and bicyclists. The chapter concludes with a discussion of applying human factors principles to the planning, design, and operation of signalized intersections.

2.1 OVERVIEW OF HUMAN FACTORS

Human factors research deals with human physical, perceptual, and cognitive abilities and characteristics and how they affect our interactions with tools, machines, and surroundings. The goals of human factors analysis in road transportation are to:

- Explain, as fully as is possible, the information needs, processing abilities, and characteristics of road users.
- Study the human-machine-situational interactions that occur.
- Capitalize on this knowledge through improvements in engineering design and operations.

At signalized intersections, the application of human factors principles to the problems of safety and mobility requires a systems-oriented and human-centered approach. A systems approach helps capture the dynamic interaction between the road user and the roadway environment. It acknowledges that no one element can be analyzed and understood in isolation. A human-centered approach recognizes road users as the operative element within the system—the decision-makers—and focuses the engineering effort on optimizing their performance.

Human factors analysis, particularly as it relates to any element of the transportation system (including signalized intersections), includes the following tasks:

- Ensuring road users are presented with tasks that are within their respective capabilities under a broad range of circumstances.
- Designing facilities accessible to and usable by all road users.
- Anticipating how road users may react to specific situations to increase the likelihood of predictable, timely, accurate, and correct responses, thus avoiding situations that violate road users' expectations.
- Designing and applying conspicuous, legible, comprehensible, and credible traffic control devices that provide sufficient time to respond in an appropriate manner.
- Understanding how geometric design properties of width, enclosure, slope, and deflection affect users and contribute to behaviors such as speeding, yielding, and gap acceptance.

Signalized intersections serve a variety of road users, chiefly motorists, bicyclists, and pedestrians. Each road user group includes multiple user types. For example, motorists include passenger car, commercial truck, bus, and motorcycle operators. Bicyclists include recreational and commuting bicyclists with a wide range of ages and abilities. Pedestrians include all age groups (children, adults, elderly). Some pedestrians may also have cognitive, mobility, or vision impairments. Practitioners should account for road users' abilities and characteristics when designing an intersection.

At the most basic level, signalized intersections sequence the right-of-way between intersecting streams of road users. These intersections thus serve multiple functions: they allow motorists to access new streets and change directions in travel; they are junctions for bike routes; and they provide a primary connection to and from activity centers for pedestrians. Signalized intersections are often located on primary routes leading to commercial activities, which may involve motor carriers and other heavy vehicles. Intersections also serve as public right-of-way and include space for public utilities such as power and communication lines; water, sewage, and storm drainage pipes; and traffic signs and signal equipment.

Each category of road user has different needs when traversing an intersection. Motorists and bicyclists must detect the intersection on the approach, assess its relevance from a navigational perspective, respond to the applicable traffic controls, and negotiate the intersection. In a similar manner, pedestrians must identify the crossing location, maneuver to and position themselves accordingly at the crossing, activate a crossing device, and respond appropriately to the traffic controls. All users must remain vigilant for potential conflicts with other road users.

The Americans with Disabilities Act (ADA) of 1990 prohibits discrimination and ensures equal opportunity and access for persons with disabilities.⁽⁷⁾ Designing facilities that cannot be used by people with disabilities constitutes illegal discrimination under the ADA. Designing safe and usable facilities demands an understanding that persons with disabilities have varying abilities, use a variety of adaptive devices, such as motorized and non-motorized wheelchairs, guide dogs, walkers, and walking canes, and may have multiple impairments. ADA standards were updated in 2012 and serve as guidelines for the design and management of accessible facilities, not public rights-of-way.

The *Proposed Accessibility Guidelines for Pedestrian Facilities in the Public Right-of-Way*⁽⁵⁴⁾ was developed specifically for pedestrian facilities in the public right-of-way. It addresses conditions and constraints in the public right-of-way. The requirements in the proposed guidelines make allowances for typical roadway geometry and permit flexibility in alterations to existing facilities where existing physical constraints make it impractical to fully comply with new construction requirements. The proposed guidelines also include requirements for elements and facilities that exist only in the public right-of-way, such as pedestrian signals and roundabouts.⁽⁸⁾ While these guidelines are proposed and not legal standards, they do represent best practice. In some cases, State and local agencies have adopted policies and standards equal to or more stringent than those presented in the proposed guidelines.

Road users can only process a limited amount of information. The pace at which vehicle drivers and bicyclists encounter information increases with travel speed. The number of choices facing drivers and bicyclists at any one time should be minimized. The information presented should be concise, complete, explicit, and located sufficiently in advance of the choice point to allow for a comfortable response.

2.1.1 Positive Guidance

In the 1980s, FHWA's Office of Human Factors developed a series of documents advocating the explicit application of human factors-based knowledge in the design of roadways and in the design, selection, and application of information presentations targeted at vehicle users.⁽⁹⁾

Termed *positive guidance*, the concept focuses on understanding and making allowances for how road users—primarily motorists—acquire, interpret, and apply information in the driving task. Key positive guidance concepts are *driver expectation*, *expectancy violation*, *primacy*, and *road user error*.

Positive guidance places the driving task within the framework of a road environment viewed as an information system, where the driver is the operative element. The roadway, with its formal and informal sources of information, becomes the input. The vehicle, controlled by the driver, becomes the conduit for output. The driving task itself is subdivided into three performance levels: control, guidance, and navigation, each oriented in decreasing order of primacy and increasing order of complexity.

Positive guidance is founded on a simple concept: providing drivers with all of the information they need, in a format they can readily read, interpret and apply, and in sufficient time to react appropriately, reduces the chances of driver error and improves relative safety. Uniformity in the design and context of application of information presentations is a key component of positive guidance. Information presentations must work within the roadway information system to reinforce correct driver expectations and restructure incorrect driver expectations. They must provide the information necessary to support rapid decision-making while minimizing the potential for driver error.

Strict interpretation of the positive guidance concept implies telling the driver what he or she needs to know and nothing else. In practical application, positive guidance suggests competition for driver attention by information irrelevant to driving-related tasks can exceed drivers' information-processing limitations. This may have a negative impact on traffic safety.

This road user-based approach to information presentation is the foundation of state-of-the-art information presentation policies, standards and guidelines, including FHWA's MUTCD.⁽¹⁾ However, a growing body of research suggests that redundancy in message delivery systems may in fact improve the efficiency, safety, and/or usability of a facility. For example, pedestrians tend to begin their crossing more quickly if an audible prompt accompanies the visible pedestrian signal indication. However, there is always a risk that some users will miss or be unable to receive information that relies on only one sense (e.g., sight).

2.1.2 Roadway Safety Fundamentals

In the past, roads were considered to be "safe" if they were designed, built, operated, and maintained in accordance with nominal standards of the day. These standards were usually based on empirical data or long-standing practice. Collisions were viewed as an unavoidable outcome of the need for mobility and the inevitability of human error. When human errors resulted in collisions, the fault was perceived to lie with the road user, rather than with the road.

The approach to roadway safety has since evolved. In the explicit consideration of roadway safety, safety itself is now recognized to be a relative measure, with no road open to traffic being considered completely "safe"—only "more safe" or "less safe" relative to a particular benchmark, as defined by one or more safety measures. While the concept of "road user error" remains, it is now understood that errors and the collisions that result do not just "happen," they are "caused," and the roadway environment sometimes plays a role in that causation.

In the Institute for Transportation Engineers (ITE) *Traffic Safety Toolbox: A Primer on Traffic Safety*, Hauer refers to *nominal* safety as compliance with standards, warrants, guidelines and sanctioned design procedures, and *substantive* safety as the expected crash frequency and severity for a highway or roadway.⁽¹⁰⁾ More recently, AASHTO published the Highway Safety Manual (HSM). The HSM provides tools to practitioners to conduct quantitative safety, allowing

for safety to be quantitatively evaluated alongside other transportation performance measures such as traffic operations, environmental impacts, and construction costs in project planning and development decision-making.⁽¹¹⁾

By addressing the environmental and situational elements that contribute to the occurrence of driver error, the forgiving roadway seeks to break the chain of causation between the erroneous decisions and/or actions and their undesirable outcomes (e.g., crashes). The forgiving roadway concept is largely information driven. It is predicated on meeting the expectations of road users—motorists, bicyclists, and pedestrians—and assuring that they get needed information when it is required, in an explicit and usable format and in sufficient time to react. Implicit in the forgiving roadway approach is that the information-processing capabilities of users must at no time be overtaxed by either an overabundance of potentially relevant information or by the additive presence of information not immediately relevant to the task of negotiating the roadway.

2.2 INTERSECTION USERS

Knowing the performance capabilities and behavioral characteristics of road users is essential for designing and operating safe and efficient signalized intersections. All road users deal with human factors, no matter how they use the road. For example, older drivers, older pedestrians, and people with visual disabilities all frequently share the characteristic of longer perception-reaction times. The following section discusses human factors issues common to all road users, followed by a discussion of issues specific to motorists, bicyclists, and pedestrians.

2.2.1 Human Factors Common to All Road Users

The task of traveling on the roadway system, whether by motor vehicle, bicycle, or foot, primarily involves searching for, finding, understanding, and applying information, as well as reacting to the appearance of unanticipated information. Once found and understood, the relevance of this information must be assessed and decisions and actions taken in response. This activity is cyclic, often occurring many times per second in complex, demanding environments. The capabilities of human vision, information processing, and memory all affect a road user's ability to use an intersection, and these may affect the likelihood of user error. The following sections discuss each of these factors.

Human Vision

Road users who are not visually impaired receive most of their information visually. The human visual field is large; however, the area of accurate vision is quite small. Drivers, for example, tend to scan a fairly narrow visual field ahead of them. Drivers do not dwell on any target for long; studies indicate that most drivers become uncomfortable if they cannot look back at the roadway at least every two seconds.⁽¹²⁾ This means that information searches and the reading of long messages are carried out during a series of glances rather than with one long look. Complex or cluttered backgrounds, such as those shown in Exhibits 2-1 and 2-2, make individual pieces of information more difficult to identify and can make the driving task more difficult. Looking at irrelevant information when it is not appropriate to do so may cause drivers to overlook relevant information or fail to accurately monitor a control or guidance task. This is of particular concern in areas of high workload, at decision points, and at locations where there is a high potential for conflict (e.g., intersections and crosswalks).



Exhibit 2-1. Signs confused with background information.



Exhibit 2-2. Example of sign clutter.

Information Processing and Memory

Road users perform best under moderate levels of demand. Information overload or underload tends to degrade performance. Consider the example of driving. The presentation of information in circumstances of low driving-task demand is commonly assumed to avert boredom; however, this assumption is untested.⁽¹³⁾ During periods of high task demand, however, it is known that the duration of drivers' glances at signs become shorter, as more time is needed to accommodate control and guidance tasks and less is available for reading signs. Extra effort should be made to limit information presentations to those immediately relevant to the driving task where circumstances of high workload are apt to occur.

Humans have limited short-term memory. Only a small percentage of what they see is actually remembered, including information presentations viewed while driving, bicycling, or walking. Long-term memory is made up of experiences ingrained through repetition. These are the source of our expectations, which play a strong role in the performance of all road users. Information about an upcoming condition or hazard should be proximate to its location, or repeated at intervals for emphasis.

In addition to expectations, road users recognize and use patterns to anticipate and prepare for situations similar to those experienced before. When things turn out as expected, performance is often rapid and error-free. When expectations are violated, surprise results, and new information must be gathered so the user can rethink a response. Adherence to uniform principles of information presentation in the design and application of traffic control devices—and managing the overall information load placed on road users—is vital to ensure that the users get the information they need when they need it, in a form that they can recognize and understand and in time to perceive and react to it in an appropriate manner.

User Error

Information presentations must be conspicuous, legible, readable at a glance, and explicit as to their meaning. A study cited in the NCHRP 600 Human Factors Guidelines⁽¹⁵³⁾ refers to an increase in both the number of glances and duration of each glance as the length of a message increases, while the retention of the information significantly decreases for messages longer than eight characters. Uniformity and consistency are paramount. For example, drivers must receive the same clues and information in similar situations so that their expectations will be consistent with reality, or their expectations will be restructured accordingly. The presentations must be located in advance to provide time to react, and they must be spaced—both from each other and from other competing sources of information—so as not to confuse or overload the road user.

Drivers in particular often have difficulties following through the sequence of driving tasks, which leads to driving errors. The most common driving errors include improper lookout (faulty visual surveillance), inattention, false assumption, excessive speed, improper maneuvers, improper evasive action, and internal distraction.⁽¹⁴⁾

The risk of user error tends to increase when needed information:

- **Is missing or incomplete.**
- **Is difficult to locate, read, or interpret.**
- **Lacks credibility.**
- **Leads to false expectations.**
- **Provides insufficient time for decision and appropriate action.**

Bicyclists can also have similar difficulties. These errors often result from:

- Inadequate input for the task at hand (e.g., night time travel, poor sight distance, inconspicuous traffic control devices, complex intersection layouts, insufficient advance signing).
- Uncommon events (e.g., violations by other road users, emergency vehicles traveling through red light).
- Inappropriate inputs (e.g., extraneous or conflicting signage).
- The shedding of important information when overloaded.
- Stress, frustration, inexperience, fatigue, intoxication.
- Imperfect decision-making.

In summary, the engineer should be aware of road users and their needs and limitations with regard to signalized intersections. Information displayed in advance of and at the intersection needs to be consistent, timely, legible, and relevant. Awareness of how human factors play a role in the task of using the intersection will go a long way toward reducing error and the collisions this may cause.

Age

Age and experience have a significant effect on the ability of drivers, bicyclists, and pedestrians to use an intersection. For example, young drivers have a quicker perception and reaction time yet often lack the judgment to perceive something as being hazardous, something only experience can teach a driver. In contrast, older drivers have the experience yet may lack the perception and reaction time.⁽¹⁵⁾

According to the FHWA *Highway Design Handbook for Older Drivers and Pedestrians*, half of fatal crashes involving drivers 80 or older took place at intersections.⁽¹⁵⁾ This document also points to a large body of evidence showing higher crash involvement among older drivers, particularly with crash types that require complex speed-distance judgment under time constraints, such as a left-turn against oncoming traffic. As shown in Exhibit 2-3, fatal crash involvement is much higher at signalized intersections for drivers less than 20 years old and more than 70 years old.

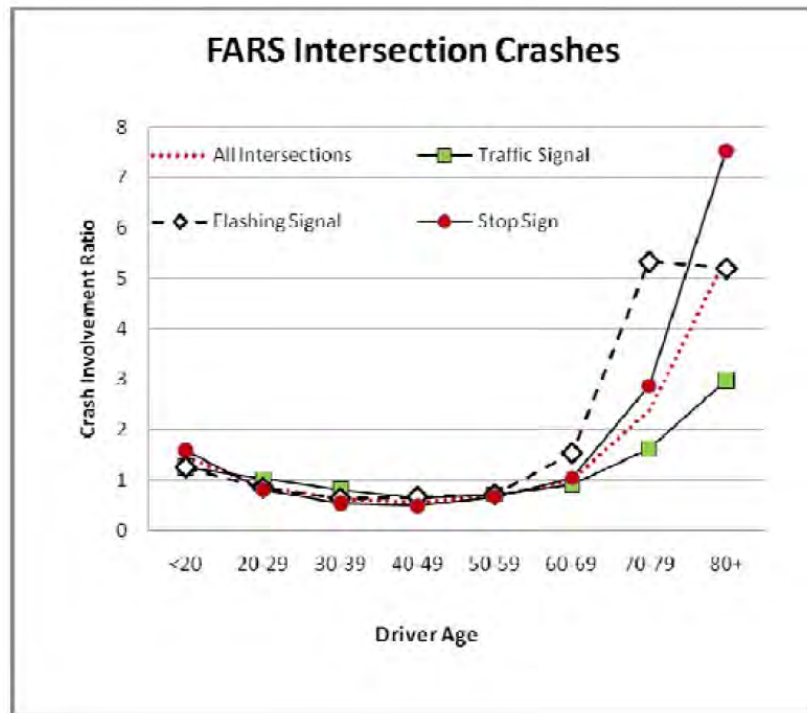

Exhibit 2-3. Fatal two-vehicle intersection crashes by traffic control device and driver age
 Source: NHTSA, *Intersection Crashes among Drivers in Their 60s, 70s, and 80s*, 2011.

As one ages, specific functions related to the driving task may deteriorate, such as vision, depth perception, hearing, sensation, and cognitive and motor abilities. Decreased peripheral vision and a decreased range of motion in an older person's neck may limit their ability to attend to a traffic signal while searching for a gap in traffic when making a left turn. Sorting out visual distractions at intersections can be difficult. Cognitive changes require that older drivers need more time to recognize hazards and respond. It would also appear that driving situations involving complex speed-distance judgments under time constraints, as found at many signalized intersections, are problematic for older drivers and pedestrians.

The following specific tasks were reported as being problematic for older road users:

- Reading street signs.
- Driving through an intersection.
- Finding the beginning of a left-turn lane at an intersection.
- Judging a gap in oncoming traffic to make a left turn or cross the street (both as drivers and pedestrians).
- Following pavement markings.
- Responding to traffic signals.

Young drivers aged 16 to 24 have a higher risk (2.5 times) of being involved in a collision compared to other drivers.⁽¹⁶⁾ Young pedestrians (i.e., pedestrians under the age of 12) also have a higher risk of being in a collision. These younger road users may:

- Have difficulty judging speed, distance, and reaction time.
- Tend to concentrate on near objects and other vehicles.
- Miss important information.
- Have a poor perception of how hazardous a situation can become
- Fix their eyes on an object for longer periods.
- Have difficulty integrating information.
- Be easily distracted by unrelated events (e.g. cell phone use, texting, and using GPS).
- Underestimate their risk of being in a collision.
- Make less effective driving and crossing decisions.

2.2.2 Motorists

Motorists account for by far the most number of trips taken on roads. There are more than 254 million licensed vehicles in the United States.⁽¹⁷⁾ Traffic engineers have traditionally sought to design and operate intersections with a typical driver in mind, trying to best accommodate their needs in terms of their ability to perceive, react, and safely navigate through an intersection. This being so, bicyclists and pedestrians are often at a disadvantage at many intersections.

Traffic engineers must be conscious of the need to design for a range of human characteristics and responses. Specific subgroups of drivers may have an elevated risk of being involved in a collision (e.g., teenage drivers, older drivers, and aggressive drivers).

Most drivers traveling through signalized intersections will be operating passenger vehicles. These may be cars, minivans, pickups, or sport utility vehicles (SUVs). A total of 6,763 people died in intersection-related motor vehicle crashes in 2010. These deaths occurred in 2,415 crashes involving 4,471 motor vehicles.⁽¹⁸⁾ However, commercial vehicles (tractor-trailers, single-unit trucks, and cargo vans) account for more than their share of fatal collisions, based on fatal crash rates per mile.⁽¹⁹⁾ These vehicles need to be properly accommodated at intersections.

Vehicle acceleration from a stationary position, braking distances required, safe execution of a left or right turn, and provision of adequate storage in turning lanes are important items to consider.

Exhibit 2-4 identifies general characteristics of vehicle types, and Exhibits 2-5 and 2-6 show the frequency of fatalities and injuries by mode, respectively.

Exhibit 2-4. Estimated number of registered vehicles by type, 2010

Vehicle Type	Number of Registered Vehicles	Percent of Total
Light duty vehicle, short wheel base	190,202,782	76
Motorcycle *	8,212,267	3
Light duty vehicle, long wheel base	40,241,658	16
Truck, single-unit 2-axle 6-tire or more **	8,217,189	3
Truck, combination	2,552,865	1
Bus	846,051	< 1
Total	250,272,812	

*The new category Light duty vehicle, short wheel base replaces the old category Passenger car and includes passenger cars, light trucks, vans and sport utility vehicles with a wheelbase (WB) equal to or less than 121 inches.

**The new category Light duty vehicle, long wheel base replaces Other 2-axle, 4-tire vehicle and includes large passenger cars, vans, pickup trucks, and sport/utility vehicles with wheelbases (WB) larger than 121 inches.

Source: Bureau of Transportation Statistics, 2010.⁽¹⁷⁾

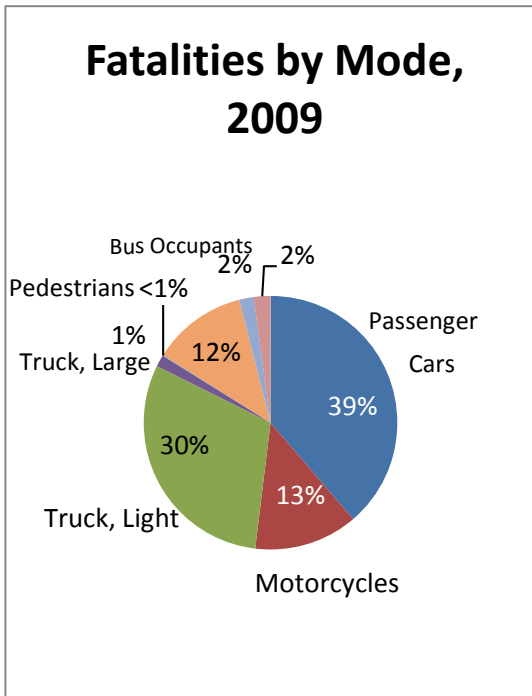

Exhibit 2-5. Fatalities by mode, 2009.

Source: Bureau of Transportation Statistics, 2009.

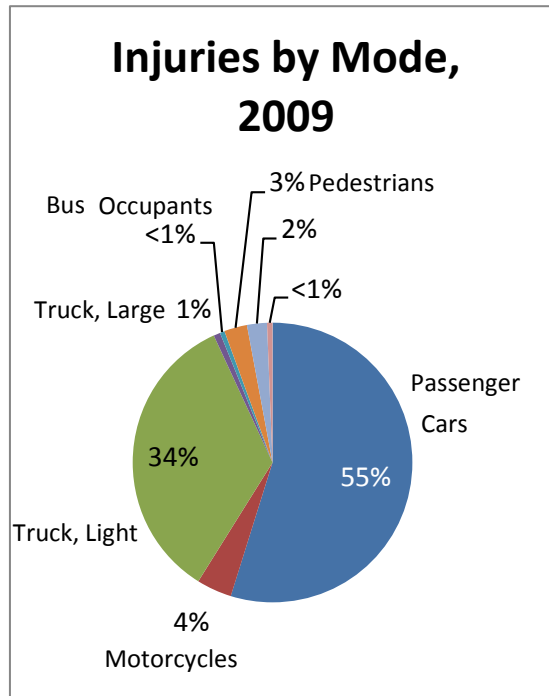

Exhibit 2-6. Injuries by mode, 2009.

Source: Bureau of Transportation Statistics, 2009.

Exhibit 2-7. Proportion of crashes by collision type at four-leg signalized intersections. (Excerpted from Highway Safety Manual (2010), Table 10-6)

Collision Type	Percent
Head on	5
Sideswipe	12
Rear end	43
Angle	27
Ran Off Road	6
Bicycle/Pedestrian	<1
Other	6
TOTAL	100

As shown in Exhibit 2-7, the most frequently occurring collision is a rear-end crash, which represents 43 percent of all reported intersection crashes in the database.

States commonly include strategies targeting signalized intersections in their Strategic Highway Safety Plans (SHSP) spanning engineering, enforcement, and educational opportunities.

The engineering improvements may include:

- Reduce frequency and severity of intersection conflicts through traffic control and operational improvements.
- Reduce frequency and severity of intersection conflicts through geometric improvements.
- Improve sight distance at signalized intersections.
- Improve driver awareness of intersections and signal control.
- Improve driver compliance with traffic control devices.
- Improve access management near signalized intersections.
- Improve drainage in intersection and on approaches.⁽²¹⁾

Red Light Running

One primary cause of collisions at signalized intersections is when a motorist enters an intersection when the red signal is displayed, and as a consequence collides with another motorist, pedestrian, or bicyclist who is legally within the intersection. Red light running may occur due to poor engineering, distraction, inattention, or willful disregard. Those who deliberately violate red lights tend to be younger, male, less likely to use seat belts, have poorer driving records, and drive smaller and older vehicles.

According to the National Highway Traffic Safety Administration's Traffic Safety Facts 2008 Report, there were 762 deaths and 165,000 persons injured by red-light running.⁽²²⁾ A study of Highway Safety Information System (HSIS) data determined that red light runners cause 16 to 20 percent of all collisions at signalized intersections.⁽²³⁾

Countermeasures proposed to address red light running are removal of unwarranted traffic signals, changing the signal timing, improving the visibility of the traffic signal, or enforcement. An example of red light running enforcement cameras is shown in Exhibit 2-8.



Exhibit 2-8. Enforcement cameras, as shown in the photo above, are used at signalized intersections to identify red light runners.

Source: Brian Chandler

Driver Distraction

Despite the complexity of the driving task, drivers commonly engage in other tasks while operating a motor vehicle. While these tasks may seem trivial, they take the attention of the driver away from the task of driving. An estimated 16 percent of fatal crashes in 2009 involved reports of distracted driving.⁽²⁴⁾ Drivers involved in collisions at intersections were more likely to report that they “looked but didn’t see.” According to a 2010 NHTSA report, 32 percent of drivers involved in collisions between 2005 and 2007 were distracted by the following sources:⁽²⁵⁾

- Conversing with a passenger (15.9%).
- Cell phone use/texting (3.4%).
- Other objects within the vehicle (3.2%).
- The actions of other occupants (3.0%).
- Retrieving objects from the floor/seat (2.0%).
- Eating or drinking (1.7%).
- Adjusting the radio/CD player (1.2%).
- Retrieving objects from another location (0.7%).
- Smoking (0.5%).
- Reading map/directions/newspaper (0.4%).
- Adjusting other vehicle controls (0.3%).
- Talking on a CB radio (0.2%).

2.2.3 Bicyclists

Bicycle travel is an important component of any multimodal transportation system. Bicycle travel is healthy, cost effective, energy efficient, and environmentally friendly. Traditionally, the most popular form of bicycle travel is recreational bicycling. Given the increases in traffic congestion over the past few decades, particularly in urban areas, the number of people using bicycles to commute to work is on the rise.⁽²⁶⁾

Bicyclists have unique needs at signalized intersections. Bicyclists are particularly vulnerable because they share the roadway with motorists and are required to follow the same rules of the road, yet they do not possess comparable size, speed, and ability to accelerate as their motor vehicle counterparts. Consequently, roadway characteristics such as grades, lane widths, intersection widths, and lighting conditions influence the safety and operations of bicyclists to a larger degree than they do motor vehicles. External conditions such as inclement weather also significantly affect bicyclists’ performance.

Providing safe, convenient, and well-designed facilities is essential to encourage bicycle use. To accomplish this, planning for bicycle use, whether existing or potential, should be integrated into the overall transportation planning process.⁽²⁶⁾

Providing a safe and attractive environment for bicyclists requires special attention to the types of bicycle users, their characteristics and needs, and factors that influence bicyclist safety.

Bicycle Users

Bicyclists range widely in terms of skills, experience, and preferences. An FHWA report defined the following general categories (A, B, and C) of bicycle user types⁽²⁷⁾:

- “**A**dvanced or experienced riders are generally using their bicycles as they would a motor vehicle. They are riding for convenience and speed and want direct access to destinations with a minimum of detour or delay. They are typically comfortable riding with motor vehicle traffic; however, they need sufficient operating space on the traveled way or shoulder to eliminate the need for either [them] or a passing motor vehicle to shift position.
- “**B**asic or less confident adult riders may also be using their bicycles for transportation purposes, e.g., to get to the store or to visit friends, but prefer to avoid roads with fast and busy motor vehicle traffic unless there is ample roadway width to allow easy overtaking by faster motor vehicles. Thus, basic riders are comfortable riding on neighborhood streets and shared use paths and prefer designated facilities such as bike lanes or wide shoulder lanes on busier streets.
- “**C**hildren, riding on their own or with their parents, may not travel as fast as their adult counterparts but still require access to key destinations in their community, such as schools, convenience stores and recreational facilities. Residential streets with low motor vehicle speeds, linked with shared use paths and busier streets with well-defined pavement markings between bicycle and motor vehicle, can accommodate children without encouraging them to ride in the travel lane of major arterials” (cited on p. 6, reference 22).

Bicyclist Dimensions

Although the physical width of a bicycle is approximately 30 inches, the forward movement of bicyclists requires a minimum operating width of 4 ft and a preferred operating width of 5 ft to accommodate the natural side-to-side movement that varies with speed, wind, and bicyclist proficiency.⁽²⁸⁾ In addition, because most bicyclists ride a distance of 32 to 40 inches from a curb face, this area should be clear of drain inlets, utility covers, and other items that may cause the bicyclist to swerve. Where drain inlets are unavoidable, their drainage slots should not run parallel to the direction of travel, as this can cause a bicyclist to lose control.

Bicycle User Needs

The general objectives for bicycle travel are similar to those for other modes: to get from point A to point B as efficiently as possible on a route that is safe and enjoyable. At the same time, the mode of travel must integrate with other forms of transportation that use the roadway network and not adversely affect other modes or uses.

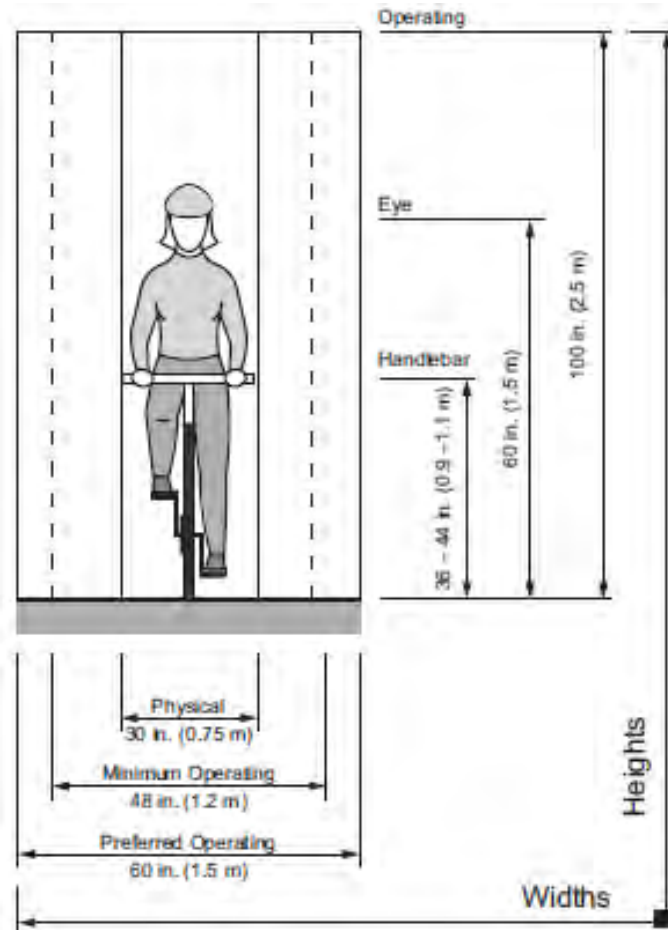

Exhibit 2-9. Typical dimensions of a bicyclist.

Source: AASHTO, *Guide for the Development of Bicycle Facilities, 4th Edition*, 2012.

- **Width** – The minimum operating width of 4 ft, sufficient to accommodate forward movement by most bicyclists, is greater than the physical width momentarily occupied by a rider because of natural side-to-side movement that varies with speed, wind, and bicyclist proficiency. Additional operating width may be needed in some situations, such as on steep grades, and the figure does not include shy distances from parallel objects such as railings, tunnel walls, curbs, or parked cars. In some situations where speed differentials between bicyclists and other road users are relatively small, bicyclists may accept smaller shy distances.
- **Height** – The operating height of 8.3 ft can accommodate an adult bicyclist standing upright on the pedals.⁽²⁶⁾

The Danish Road Directorate identifies key elements to incorporate in the planning of cycling facilities:

- **Accessible and coherent.** The bicycle network should run directly from residential areas to the most important destinations, such as schools, workplaces, and shopping and entertainment centers.
- **Direct and easy.** If the bicycle network is not direct, logical, and easy to use, some bicyclists will choose roads not planned for bicycle traffic.
- **Safe and secure.** Adequate visibility and curve radii should make it possible for bicyclists to travel safely at a minimum of 15 mph. Parked cars, vegetation, barriers, etc. can result

in poor or reduced visibility. Awareness of the presence of bicyclists can be heightened by signing and road marking.

- **Self-explanatory design.** Edge lines, bicycle symbols, colored tracks and lanes, and channelization of traffic make it easy to understand where bicyclists should place themselves. Uniformity over long stretches is an important component.

Other elements that should be considered in the planning and design of bicycle facilities include bike lanes, pavement surface conditions, drainage inlet grates, refuge, and lighting.⁽²⁹⁾

Bicycle Safety

In 2009, 630 bicyclists were killed and 51,000 injured in motor vehicle traffic crashes.^{(30),(31)} Bicyclist deaths accounted for 2 percent of all motor vehicle traffic fatalities and made up 2 percent of all the people injured in traffic crashes during the year. However, many bicycle crashes either do not involve a motor vehicle or go unreported. A study of records at eight hospitals in three States found that 55 percent of bicycle injury events in a roadway did not involve a motor vehicle.⁽³²⁾ In addition, the study found that 40-60 percent of bicycle-motor vehicle crashes were not reported to the official State files.

Bicycle-motor vehicle crashes are a concern at intersections. An FHWA report identified three common crash types that occur at intersections:⁽³³⁾

- Motorist left turn facing the bicyclist.
- Bicyclist left turn in front of a motorist.
- Bicyclist ride-out from a stop sign or flashing red signal.

Exhibit 2-10 presents the typical conflicts for bicyclists at a signalized intersection. As the exhibit shows, bicyclists going straight through a signalized intersection encounter the same conflicts as a motor vehicle (shown in the exhibit as open circles), but also encounter additional conflicts from motor vehicles turning right from the same direction.

Left turns for bicyclists are even more complex and depend on the type of bicyclists. For small- to medium-sized signalized intersections, Category A and some Category B bicyclists will generally choose to take the lane as a motor vehicle, as it is the fastest way through the intersection; the remainder will likely feel more comfortable traveling as a pedestrian, as shown in Exhibit 2-10. As the size of the intersection increases, the difficulty for bicyclists to weave to the left turn lane can be daunting for Category B and even some Category A bicyclists.

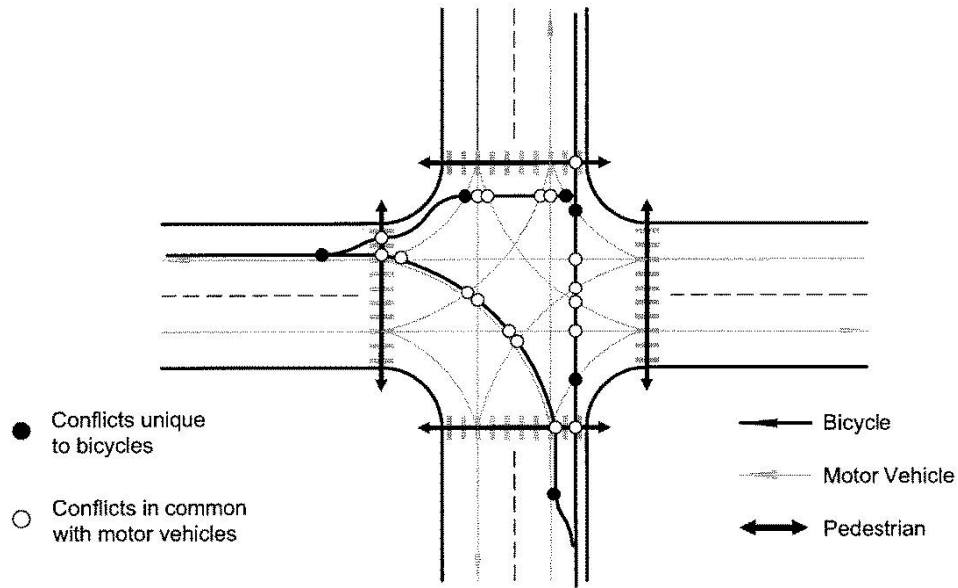

Exhibit 2-10. Bicyclist conflicts at signalized intersections.

From 2005-2009, 1,357 bicycle fatalities occurred at intersections on American roads, according to the Fatality Analysis Reporting System (FARS) database maintained by NHTSA, with 564 of the fatalities occurring at signalized intersections. Intersection-related fatalities are far more common on urban rather than rural roads, and during daylight instead of after dark.

FARS data indicated that 15 percent of all bicycle collisions occur at signalized intersections. In 2010, FARS cited that 30 percent of police-reported collisions between bicyclists and motorists occurring at intersections take place within the pedestrian crosswalk.

2.2.4 Pedestrians

Walking is the oldest and most basic form of transportation. Nearly every trip includes a walking element. According to the *2009 Nationwide Personal Transportation Survey*, 10.4 percent of all daily trips occurred via the walk mode.⁽³⁴⁾ People walk for a variety of reasons: social and recreational activities, trips to school or church, shopping, commuting to and from work, and connecting to or from other modes of transportation. There has also been an increase in non-motorized travel due to successful ongoing public health campaigns that encourage people to walk in lieu of motorized commuter transportation. Activities often concentrate on the corners of intersections where pedestrian streams converge, people interact and socialize, and people wait for crossing opportunities.

The variety of pedestrian users includes persons of all ages, with and without disabilities, persons in wheelchairs, and persons with strollers, freight dollies, luggage, etc.; an example is given in Exhibit 2-11. The design of intersection facilities should accommodate all types of pedestrians, because the user cannot be anticipated.



Exhibit 2-11. Examples of pedestrians of various abilities preparing to cross an intersection.

Pedestrian Dimensions

Research has shown that the ambulatory human body encompasses an ellipse of 18 by 24 inches.⁽³⁵⁾ This dimension, however, does not account for a variety of scenarios, including pedestrians walking side by side; persons using canes, walkers, dog guides, or wheelchairs; persons with shopping carts or baby carriages; and so on. Exhibit 2-12 shows dimensions for various types of pedestrians.

The Americans with Disabilities Act Accessibility Guidelines (ADAAG) specifies a 60-inch square area to allow a wheelchair user to make a 180-degree turn (Exhibit 2-13).⁽³²⁾ For parallel approaches, ADAAG specifies a minimum low-side reach of 9 inches and a maximum high-side reach of 54 inches. For a forward approach, ADAAG specifies a minimum low-reach point of 15 inches and a maximum high-reach point of 48 inches.

Exhibit 2-12. Typical dimensions for a sample of types of pedestrians.

User and Characteristic	Dimension	Affected Intersection Features
Pedestrian (walking)		
Width	1.6 ft	Sidewalk width, crosswalk width
Wheelchair		
Minimum width	2.5 ft	Sidewalk width, crosswalk width
Operating width	3.0 ft	width, ramp landing areas
Person pushing stroller		
Length	5.6 ft	Median island width at crosswalk
Skaters		
Typical operating width	6 ft	Sidewalk width

Source: (6), as adapted from (28).

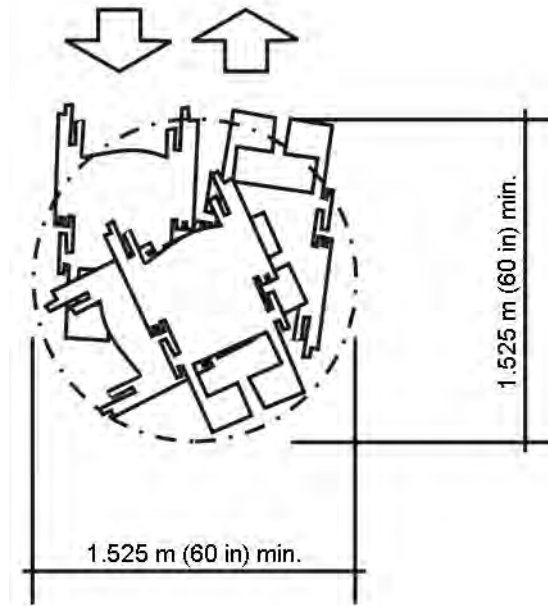

Exhibit 2-13. Typical dimensions for a turning wheelchair.

Source: U.S. Department of Justice, *ADA Standards for Accessible Design (ADAAG)*. 2010.

Pedestrian Characteristics

Pedestrian walking speeds generally range between 2.5 to 6.0 ft/s.⁽³⁾ The MUTCD (Page 497 Sect. 4E.06-07, Paragraph 7) uses a walking speed of 3.5 ft/s for determining crossing times.⁽¹⁾ However, FHWA pedestrian design guidance recommends a lower speed in general to accommodate users who require additional time to cross the roadway, and in particular a lower speed in areas where there are concentrations of children and or elderly persons.^{(37),(38)} The *HCM 2010* indicates that if elderly persons constitute more than 20 percent of the total pedestrians, the average walking speed decreases to 3.0 ft/s.⁽³⁹⁾



Exhibit 2-14. Crosswalks are used by a variety of users with different speed characteristics.

A general rule of thumb indicates that pedestrians at crossings are willing to wait only 30 seconds, at which point they will begin to look for opportunities to cross, regardless of the walk indication and the crossing location.⁽²⁾ Shorter cycle lengths benefit pedestrians, particularly where pedestrians often need to cross two streets at a time to travel in a diagonal direction, as well as drivers, who experience generally shorter delays.

Pedestrian Conflicts

Exhibit 2-15 presents the typical conflicts between pedestrians and motor vehicles at a signalized intersection.

- **Vehicles turning right on red.** Where allowed by law, this conflict occurs most often when the driver of a vehicle turning right on red is looking to the left and does not perform an adequate search for pedestrians approaching from the right and crossing perpendicularly to the vehicle. In addition, the sound of vehicles turning right on red masks audible cues used by blind pedestrians to determine the beginning of the crossing phase.
- **Vehicles turning right on green.** This conflict occurs when vehicles do not yield to a pedestrian crossing in the parallel crosswalk.
- **Vehicles turning left on green.** This conflict occurs at intersections with permissive left turns where vehicles may be focused on selecting an acceptable gap in oncoming vehicular traffic and do not see and/or yield to a pedestrian in the conflicting crosswalk.
- **Vehicles running the red light.** This conflict is the most severe due to the high vehicular speeds often involved.

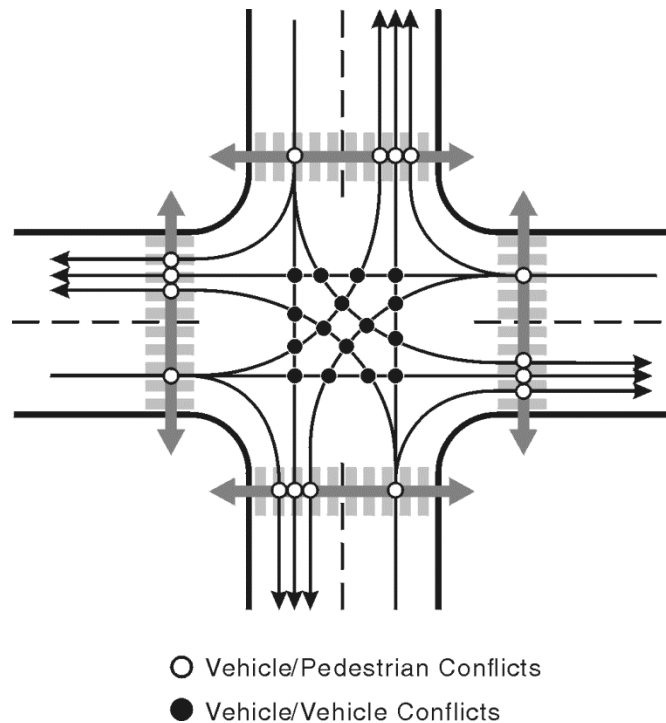

Exhibit 2-15. Pedestrian conflicts at signalized intersections.

Large signalized intersections with multiple lanes on each approach present the pedestrian with the possibility of having a vehicle in one lane yield but having a vehicle in the adjacent lane continue without yielding. The vehicle that has yielded may block the pedestrian's and other motorists' view of each other, thus putting the pedestrian at greater risk. This type of conflict may occur at signalized intersections in the following situations:

- *Double right-turn movements.* These take the form of either two exclusive right-turn lanes or one exclusive right-turn lane and a shared through-right lane.
- *Permissive double left-turn movements.* These are not common but are used in some jurisdictions, either with permissive-only phasing or with protected-permissive phasing.

Pedestrian Safety

Pedestrian safety must be a particular concern at signalized intersections, particularly those with a high volume of motorized vehicles. Pedestrians are vulnerable in an environment surrounded by large, powerful, and fast-moving vehicles. In 2009 there were 4,092 pedestrian fatalities involved in motor vehicle crashes, which represents 12 percent of all the 33,808 motor vehicle deaths.⁽²⁹⁾ An estimated 59,000 pedestrians were injured in motor vehicle collisions during this period.⁽²⁹⁾

Of all crashes between single vehicles and pedestrians in 2009, 1,063 (26 percent) occurred at intersections (both signalized and unsignalized).⁽¹⁸⁾ Speed plays a major role in motorist-pedestrian collisions, particularly fatalities; a pedestrian struck at 40 mph has an 85 percent chance of being killed, at 30 mph the probability of fatality is 45 percent, and at 20 mph the probability of fatality drops to 5 percent.⁽³⁹⁾ Compounding the problem, motorists rarely stop to yield to a pedestrian when their speeds are greater than 45 mph; they are likely to stop when their speeds are less than 20 mph.⁽⁴⁰⁾

From the driver's perspective, the mind goes through five psychological steps to "see" an object such as a pedestrian: selection, detection, recognition, location, and prediction. The speed

of the vehicle and the experience of the driver play critical roles in the driver's ability to detect pedestrians and react appropriately. Research shows that difficulties in information processing and driver perception contribute to approximately 40 percent of all traffic crashes involving human error.⁽⁴⁰⁾

The time required for a driver to detect a pedestrian, decelerate, and come to a complete stop is frequently underestimated or not even considered as part of the geometric design of an intersection. AASHTO's *A Policy on Geometric Design of Highways and Streets* states that a brake reaction time of 2.5 seconds is considered adequate for determining stopping sight distance.⁽³⁾ Additional research has suggested that the value of 2.5s has limitations and represents nearly ideal conditions with younger, alert drivers.⁽⁴¹⁾ The reaction time assumes an expected or routine condition such as a vehicle turning into or out of a driveway — more time is needed to account for an unexpected condition, such as a child darting into the street. A conservative perception-reaction time estimate for a “surprise” condition is 4.8 s.⁽⁴⁰⁾ Many things can impact the sight distance that allows the driver and pedestrian to see each other: landscaping, parked vehicles, traffic control devices, street furniture, etc. The practitioner must be mindful of these elements, particularly given that two-dimensional plans do not necessarily reflect the three-dimensional field of vision from the pedestrian and driver vantage points.

The combination of vehicle speed and visibility (or lack thereof) is a critical reason that the majority of motorists involved in pedestrian collisions claim that they “did not see them until it was too late.”⁽⁴⁰⁾

Accessibility for pedestrians is also a key element. The ADA of 1990 mandates, among other things, that transportation facilities be accessible to meet the diverse functional needs of people with disabilities.⁽⁷⁾ This requires that new or altered facilities be designed to allow pedestrians with access and functional needs to identify the crossing location, access the pushbutton, know when to cross, and know where to cross. The ADAAG published by the U.S. Access Board in 1991 identifies minimum design standards that must be applied to all new construction or alteration projects to adequately accommodate people with disabilities.⁽³⁶⁾ Accommodation of all users' needs should be included into the construction cost of an improvement. Note that facilities that are designed above the minimum standards generally improve the safety and accessibility for all pedestrians.

2.3 APPLYING HUMAN FACTORS

To reduce road user error at signalized intersections, the information necessary to permit relatively safe performance in an inherently hazardous environment must be effectively communicated. The design of the roadway network, including the intersections, should inherently convey what to expect to the various users. Road users must receive information in a form they can read, understand, and react to in a timely fashion. This information must reinforce common road user expectations or, if uncommon elements are present, emphatically communicate alternative information with sufficient time to react.

Failure to fully and adequately communicate the circumstances to be encountered by the road user increases the risk of hesitation, erroneous decision-making and incorrect action. Road users will rely on experience rather than their perceptions (however incomplete) of the situation at hand when their expectations are not met.

A fundamental premise of human factors is that insufficient, conflicting, or surprising information reduces both the speed and accuracy of human response. The following bullet items offer key information regarding the application of human factors principles in the analysis and design of a signalized intersection:

- All road users must first recognize signalized intersections before they can respond.
- All road users must have a clear presentation of the intersection on approach, or be appropriately forewarned by traffic control devices.
- Adequate visibility for nighttime operations is required.
- Navigational information must be available sufficiently in advance to allow for speed and path adjustments such as slowing to execute turns and lane changes.
- Signal indications must be visible from a sufficient approach distance for the user to perceive and react to changes in the assignment of right-of-way and the presence of queued traffic in a safe manner, according to the MUTCD.⁽¹⁾
- Phasing and change and clearance intervals for both vehicles and pedestrians must be suited to the characteristics and mix of road users using the intersection.
- The geometric aspects of the intersection, such as the presence of medians, curb radius, lane width, and channelization, and the implications of lane choices, must be clear.
- Points of potential conflict, particularly those involving vulnerable road users, must be evident and offer the approaching driver and pedestrian a clear view of each other.
- The route through the intersection itself must be explicit to avoid vehicles encroaching on each other.

CHAPTER 3

Data Collection and Warrants

TABLE OF CONTENTS

3.0	DATA COLLECTION AND WARRANTS	
3.1	Commitment.....	3-2
3.2	Where Do You Start? Importance of an Engineering Analysis and Study.....	3-2
3.3	Intersection Data Collection Needed	3-2
3.4	Intersection Counts	3-2
	3.4.1 What is a Typical Day?.....	3-3
	3.4.2 Procedures for Future Intersections.....	3-3
	3.4.3 Vehicle Classification	3-4
	3.4.4 Pedestrians	3-4
	3.4.5 Bicyclists.....	3-5
	3.4.6 Speed Study of Each Approach	3-5
	3.4.7 Knowledge of the Region	3-5
3.5	Traffic Signal Warrants	3-6
	3.5.1 What do the Warrants Constitute?	3-6
	3.5.2 Volume Warrants.....	3-6
	<i>Warrant 1: Eight-Hour Vehicular Volume</i>	3-6
	<i>Warrant 2: Four-Hour Volume</i>	3-6
	<i>Warrant 3: Peak Hour Volume</i>	3-6
	3.5.3 Specialty Conditions.....	3-7
	<i>Warrant 4: Pedestrian Volume</i>	3-7
	<i>Warrant 5: School Crossing</i>	3-7
	<i>Warrant 6: Coordinated Signal System</i>	3-7
	<i>Warrant 7: Crash Experience</i>	3-7
	<i>Warrant 8: Roadway Network</i>	3-8
	<i>Warrant 9: Intersection near a Grade Crossing</i>	3-8
3.6	When is Not Signalizing an Intersection the Right Decision?	3-9

LIST OF EXHIBITS

3-1	Automated intersection count station.....	3-3
3-2	Pedestrians crossing at a signal	3-4
3-3	Pennsylvania Avenue, Washington, DC.....	3-5
3-4	Pennsylvania Avenue, Washington, DC.....	3-5
3-5	Warrant 9: intersection near a Grade Crossing	3-8

3.0 DATA COLLECTION AND WARRANTS

3.1 COMMITMENT

When an agency decides to install a signal, they make a long-term investment of resources at a specific point on the transportation network. Signals require consistent care throughout their life. For example, agencies must respond to emergency repairs such as power outages; adjust timing due to changing traffic patterns; replace outdated equipment as the state of technology changes; and monitor safety performance for all users.

3.2 WHERE DO YOU START? IMPORTANCE OF AN ENGINEERING ANALYSIS AND STUDY

When evaluating changes to intersection traffic control, engineers can refer to a wide range of research and best practices. Some examples are the ITE Traffic Engineer's Handbook, State DOT MUTCD manuals, and the Minnesota DOT Intersection Control Evaluation (ICE).⁽⁴³⁾ Engineers should keep in mind that signaling an intersection has broad implications for the transportation network, both positive and potentially negative. For example:

- Signalizing an intersection can eliminate barriers to pedestrians created by arterials bisecting adjacent neighborhoods.
- Signals can attract drivers away from unintended by-pass routes that were previously used to avoid busy unsignalized intersections.
- Signals can reduce, but not eliminate, right angle crashes.
- Signals can significantly increase rear end crashes.

3.3 INTERSECTION DATA COLLECTION NEEDED

Studying an intersection requires a basic set of information. This list of information is not an exclusive list (e.g., in some cases detecting a horse in an Amish community is needed). However, the vast majority of intersections will require most of the items on this list:

- Number and turning movement of vehicles.
- Physical roadway attributes (e.g., number of lanes, approach grade).
- Vehicles' classification, especially specialty vehicles (e.g., school buses).
- Number of pedestrians.
- Number of bicyclists.
- Speed study of each approach.
- Knowledge of the region, such as surrounding development (e.g., large specific traffic generators).
- Location of transit stops and facilities.
- Most importantly, field observations of peak hours.

3.4 INTERSECTION COUNTS

Easily the most important piece of information that is needed to study an intersection is traffic count data. Reviewing the count is a starting point to understanding how traffic ebbs and flows throughout the day. An intersection count should cover 12 hours of a typical day and should be

conducted in 15-minute intervals. Counts typically occur manually or with automated count stations (see Exhibit 3-1). From the count, the engineer can easily start to see what movements are critical to the overall operation of the intersection.

3.4.1 What is a Typical Day?

Knowledge of the area may alter what is considered a “typical” day. A large recreational area or shopping area may require a weekend count. Recent advances in counting technology, such as automated intersection counting stations, make it easier to evaluate weekdays, weekends, holidays, and special events, and to perform counts longer than a standard, manual 12-hour count.



Exhibit 3-1. Automated intersection count station.

Source: Traffic Technology Today

<http://www.traffictechnologytoday.com/news.php?NewsID=39788>

3.4.2 Procedures for Future Intersections

Some agencies have enacted procedures to estimate traffic volumes for future intersections. Traffic impact studies commonly require estimated traffic volumes, typically completed using the guidelines found in the ITE Trip Generation Manual.⁽⁴²⁾ The practitioner should be able to generate the number of trips resulting from the proposed development. These trips are distributed over the street network to determine future traffic patterns. An engineer must be comfortable that actual traffic volume will be sufficient to require a traffic signal. Some planning agencies use traffic planning software to estimate future traffic patterns on the network. The MUTCD recommends evaluating the intersection after a year to be sure the initial assumptions were correct.

3.4.3 Vehicle Classification

Practitioners must also consider the expected types of vehicles when designing a signalized intersection. Intersection counts should capture this information. Examples of various vehicle combinations that should be counted or noted are:

- Tractor-trailer units in either single or combination trailers.
- City transit and tour buses.
- School buses.
- Large recreational vehicles in single or combination units.
- Emergency vehicles (e.g., ladder trucks).

Practitioners should note any vehicles larger than a WB-50 truck and their frequency of occurrence. These vehicles' large turning radius, long start up time, and safety impacts can affect intersection design. In some cases, larger vehicles can be calculated into Passenger Car Equivalents (PCEs) to account for their additional impacts on the system.

In addition, practitioners may adjust type and location of detection, timing parameter settings, and target lengths of turn lanes and auxiliary lanes to accommodate the queue needs of these larger vehicles.

3.4.4 Pedestrians

Pedestrians are the most vulnerable class of roadway users. Counting pedestrians is the first step to ensuring their needs are incorporated into the signal design and operations. This information is necessary to help practitioners develop signal timing and design pedestrian cross walks and refuge islands. Practitioners should also consider the environment in which an intersection is located. An area lacking in sidewalks may still have pedestrians to be accommodated at an intersection. This information can be collected during the intersection counts and should include the size of pedestrian groups, their frequency, and their walking speed.



Exhibit 3-2. Pedestrians crossing at a signal

Source: PBIC Image Library Alpena, Michigan, Dan Burden, 2006.

<http://www.pedbikeimages.org/pubdetail.cfm?picid=1019>

3.4.5 Bicyclists

Practitioners can also capture bicyclists' information during intersection counts. Bicyclists using crosswalks should be included in the pedestrian count.

3.4.6 Speed Study of Each Approach

ITE recommended practices for calculating clearance intervals requires assessing approach speeds. ITE recommends using the 85th and 15th percentile speeds for this purpose. Practitioners should also perform a "spot speed" survey for each approach. These surveys can be done manually using radar or automatically using counting technology. This information is also used to determine dilemma zone concerns.⁽⁴⁴⁾



Exhibit 3-3. Pennsylvania Ave., Washington, DC
Source: Google

3.4.7 Knowledge of the Region

Warrant analysis covers the basic reasons for installing a signal; however, a signal should also support the overall function of a regional transportation network. Signalized intersections offer the most benefits when installed at major street junctions. Signals should almost always enhance through movements of any major street while balancing access to minor streets and pedestrians. Practitioners should be aware that many mid-size cities and counties have identified key intersections in their long range transportation plan. These planning documents are often a small part of a larger planning effort that combines both transportation engineering and a vision for the community's future. Signals can also support completing connections between large industrial sites, mixed use developments, schools, and emergency services.



Exhibit 3-4. Pennsylvania Ave., Washington, DC
Source: Matthew Myers, 2011

3.5 TRAFFIC SIGNAL WARRANTS

Practitioners perform engineering studies of planned signalized intersections to predict their immediate and future impacts. The basis of every engineering study concerning signals is the set of warrants found in the MUTCD. The warrants are part of the basic principles in the MUTCD that govern the design and use of traffic control devices. In addition, Code of Federal Regulations (CFR) 655.603 adopts the MUTCD as the National standard for all traffic control devices installed on any street, highway, bikeway, or private road open to public travel (see definition in Section 1A.13). When a State or Federal agency manual or supplement is required, that manual or supplement shall be in substantial conformance with the National MUTCD.

3.5.1 What Do the Warrants Constitute?

The warrants represent the basic areas an engineer's analysis should cover: intersections where users have difficulty maneuvering through the intersection due to high mainline volumes; drivers trying to cross streets with inadequate gaps; and pedestrians trying to cross large expanses of pavement.

3.5.2 Volume Warrants

Warrant 1: Eight-Hour Vehicular Volume

Warrant 1, the Eight-Hour Vehicular Volume Warrant, is one of the most widely used and familiar warrants. It is a count of the number of entering vehicles at an intersection in an 8-hour period. The practitioner will review the operations of a "typical" day at the intersection. Overall, satisfying this warrant indicates that a signal can be a reasonable investment towards improving the overall efficiency and safety of the intersection.

The engineer will find two conditions under this warrant. The warrant is satisfied when one of the conditions is met. Condition A indicates that the total number of entering vehicles from every approach causes undue delay, and condition B is satisfied when an imbalance occurs between the major and minor route, causing undue delay to motorists entering from minor roads.

This warrant should cause the practitioner to ask "What is the typical day or week for this intersection?" For example, high-use recreational areas, such as a lake or shopping mall, are different than a city arterial serving large subdivisions.

Right-turning Vehicles. One question often asked by practitioners is, "How should we count right turning vehicle traffic?" Many times this movement is unimpeded and does not contribute to the approach delay or other operational deficiencies of the intersection. The engineer, through their judgment, may subtract the volume of right-turning vehicles from the warrant analysis, especially those turning from the side street. Practitioners should consult the policies of the local governing agency responsible for the intersection for possible details concerning right-turning vehicles.

Left-turning Vehicles – Major Approach. In some cases, major approach left turns may queue past the available storage and reduce the capacity of the approach. In this situation the engineer should consider using a heavy left turn off of the major approach to satisfy the minor approach volume. This is an example in which engineering judgment is necessary throughout a warrant analysis to determine if signaling an intersection will improve the overall operations and safety of the intersection.

Warrant 2: Four-Hour Volume and Warrant 3: Peak Hour Volume

Both of these warrants address unusually high, short duration side street traffic volumes. Practitioners should take care when using these warrants. Many types of businesses generate these volumes at any given time. In most cases, this would not constitute justification for installing

a signal. In fact, some agencies place additional emphasis on making sure these warrants are used sparingly compared to Warrant 1.

3.5.3 Specialty Conditions

Warrant 4: Pedestrian Volume

This warrant is similar in application to the previous warrants. The data necessary are major street traffic volume and pedestrian volume, and the warrant is satisfied either for four hours or a single peak hour.

Many regions of the United States have recently placed a higher emphasis on non-motorized travel. However, many arterials were built to standards that created barriers to non-motorized users. Many cities now create networks focused on non-motorized travel. Signalizing intersections for pedestrians supports these networks. Agencies and practitioners implement treatments to improve the pedestrian safety, such as enhanced crosswalks using medians and signing. Agencies may also implement other available alternatives to traditional traffic signals, such as Pedestrian Hybrid Beacons (also known as High Intensity Activated Crosswalks (HAWKs)). Additional information on the Pedestrian Hybrid Beacon is available on the FHWA Office of Safety website at:

http://safety.fhwa.dot.gov/provencountermeasures/fhwa_sa_12_012.htm.

As more communities focus their efforts on non-motorized travel, facilities more widely support bicyclists and pedestrians. Bicyclists should be counted as either vehicles or pedestrians depending on how they enter the intersection. In a community with high bicycle use, practitioners will likely encounter both at an intersection.

Warrant 5: School Crossing

This warrant is similar to Warrant 4, but deals specifically with school age pedestrians. Installing a signal can eliminate the barrier created by a busy and wide intersection that pedestrians find difficult to cross safely. Practitioners are asked to measure the frequency of adequately sized gaps in traffic flow that permit the average group of school age children cross the major street. The warrant is met if no gaps occur.

The engineer should be aware of any policies or procedures the agency has in place for school crossings, such as requiring an adult crossing guard to supervise the crosswalk. Also, these signals may “rest” in green for the majority of the day, which can cause issues for drivers who do not expect them to change. Adding advance signing helps increase drivers’ awareness when the signal is active during selected hours of the day. Pedestrian hybrid signals, mentioned previously, are an alternative to traditional signals. The city of Tucson, Arizona has been successful with these types of treatments.

Warrant 6: Coordinated Signal System

Practitioners may need to use a signal to platoon traffic flow down a major road, improving the overall effectiveness of a signalized corridor. The MUTCD warns that this warrant should not be used if the intersection spacing is less than 1,000 ft. Warrant 6 is not widely used

For signal coordination purposes, the spacing between signals should range from ¼ to ½ mile. Signal spacing less than 1,000 ft is difficult to coordinate.

Warrant 7: Crash Experience

Practitioners must analyze the intersection’s crash history as part of the engineering study. Many practitioners focus on the threshold listed in this warrant. Signals can provide some safety benefits under the right situations, but other crash types at the intersection can increase dramatically, especially rear end crashes. Often right angle crashes will decrease, but these crash types will not be completely eliminated.

Information related to assessing the impact of a traffic signal can be found in the following resources:

- Highway Safety Manual
- States Strategic Highway Safety Plans
- Crash Modification Factors (CMF) Clearinghouse website

These resources can help practitioners develop a focused, data-driven approach to reducing the severity of roadway crashes; screening the roadway network for intersections to review; quantifying safety impacts associated with modifying existing signalized intersections; and/or establishing the installation of a new signal.

Warrant 8: Roadway Network

An efficient and safe network of transportation options requires significant effort by metropolitan planning organizations, regional planning commissions, cities, counties, and State DOTs. Increased travel demand due to regional growth necessitates change. Traffic control at arterial and other major roadway intersections requires maintaining adequate levels of user service. These organizations may have conducted preliminary studies to determine which intersections should be signalized intersections or roundabouts. Practitioners who are evaluating future traffic impacts due to signals should seek out this information from these organizations.

Warrant 9: Intersection near a Grade Crossing

Practitioners must ensure that drivers and other road users are able to clear railroad tracks to prevent any conflicts from approaching trains. The figures used in this warrant offer the practitioner guidance and information on factors related to buses, tractor-trailers, and frequency of trains per day. Figure 4C-9 from the MUTCD is one of the figures related to this warrant. This warrant addresses any intersection within 140 feet of a railroad track.

Figure 4C-9. Warrant 9, Intersection Near a Grade Crossing (One Approach Lane at the Track Crossing)

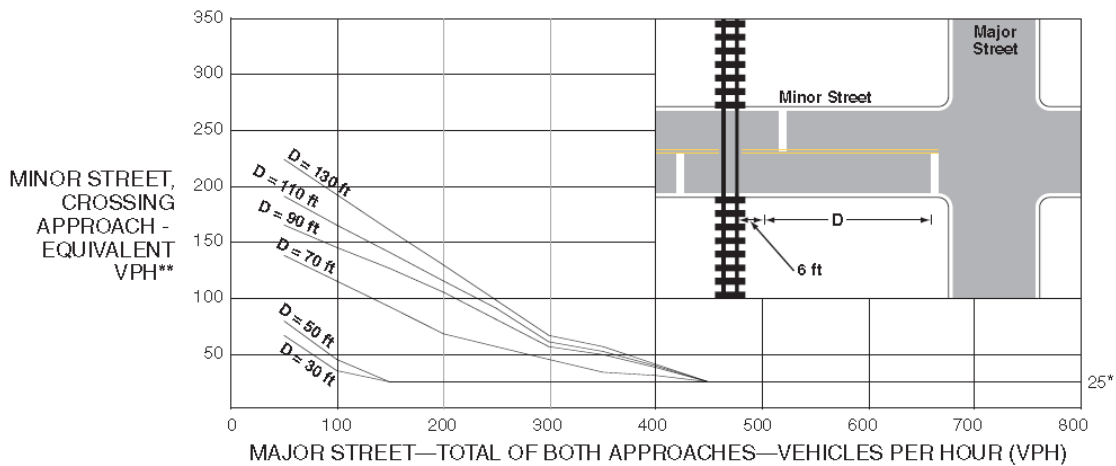

* 25 vph applies as the lower threshold volume
 ** VPH after applying the adjustment factors in Tables 4C-2, 4C-3, and/or 4C-4, if appropriate

Exhibit 3-5. Warrant 9: Intersection near a Grade Crossing.

Source: MUTCD, 2009

Preemption control shall be provided at any signal near railroad tracks installed under this warrant, and any other signalized intersection that regularly queues traffic onto a set of tracks.

3.6 WHEN IS NOT SIGNALIZING AN INTERSECTION THE RIGHT DECISION?

This is one of the perplexing questions a practitioner and the general public may ask. The MUTCD acknowledges the importance of engineering judgment. The warrants represent best practice, but a signal can dramatically change traffic patterns. Signalized intersections should complement a transportation network, even if it is only an isolated signal. Corridors with closely or oddly spaced signals are difficult to time effectively and can cause a premature decline of the network.

CHAPTER 4

GEOMETRIC DESIGN

TABLE OF CONTENTS

4.0	GEOMETRIC DESIGN	4-3
4.1	Number of Intersection Legs	4-4
4.2	Channelization	4-5
4.3	Horizontal and Vertical Alignment.....	4-10
4.4	Corner Radius	4-12
4.5	Sight Distance	4-14
	4.5.1 Stopping Sight Distance.....	4-14
	4.5.2 Decision Sight Distance	4-14
	4.5.3 Intersection Sight Distance	4-15
4.6	Pedestrian Treatments.....	4-16
	4.6.1 Curb Ramp Design	4-17
	4.6.2 Detectable Warning Surfaces	4-20
4.7	Bicycle Facilities.....	4-20
4.8	Transit Facilities	4-22

LIST OF EXHIBITS

4-1	Intersection functional boundaries	4-3
4-2	A large corner radius that impacts pedestrian safety	4-3
4-3	Potential conflicts at intersections with three and four legs	4-4
4-4	Photograph of a six-leg intersection	4-5
4-5	This raised median restricts left-turn egress movements from a driveway located between two intersections	4-6
4-6	Single point urban intersection (SPUI) with pavement marking delineation for turning movements	4-6
4-7	Various right-turn treatments may be used, depending on the speed environment.....	4-7
4-8	Providing a dedicated left-turn lane reduces potential rear end collisions between left-turning and through vehicles, increasing the capacity of the approach for both left and through traffic.....	4-8
4-9	The photo shows how double and triple left-turn lanes can be used to accommodate high-priority movements	4-9
4-10	Pedestrian refuge and bicyclist wayfinding.....	4-9
4-11	Intersection angle increases both the intersection width and pedestrian crossing distance	4-12
4-12	Intersection skew.	4-12
4-13	Design values for stopping sight distance	4-14
4-14	Design values for decision sight distance for selected avoidance maneuvers	4-15
4-15	A pedestrian grade separation treatment restricts sight distance of the traffic signal as motorists approach the intersection.	4-15
4-16	Intersection sight distance	4-16
4-17	Curb ramp components.	4-18
4-18	Examples of preferred designs	4-19
4-19	Examples of acceptable curb ramp designs.....	4-19
4-20	Examples of designs prohibited by 2010 ADAAG	4-19

4-21	This crosswalk design incorporates the use of detectable warning surfaces into the curb ramps to facilitate navigation by a visually impaired pedestrian	4-20
4-22	MUTCD diagram of right-turn lane bicycle accommodation.....	4-21
4-23	Transit facility in Santa Barbara, CA.....	4-22

4.0 GEOMETRIC DESIGN

This chapter presents geometric design guidelines for signalized intersections based on a review of technical literature and current design policy in the United States.

Geometric design of a signalized intersection involves the functional layout of travel lanes, curb ramps, crosswalks, bike lanes, and transit stops in both horizontal and vertical dimensions. Exhibit 4-1 illustrates the functional boundaries of a signalized intersection.

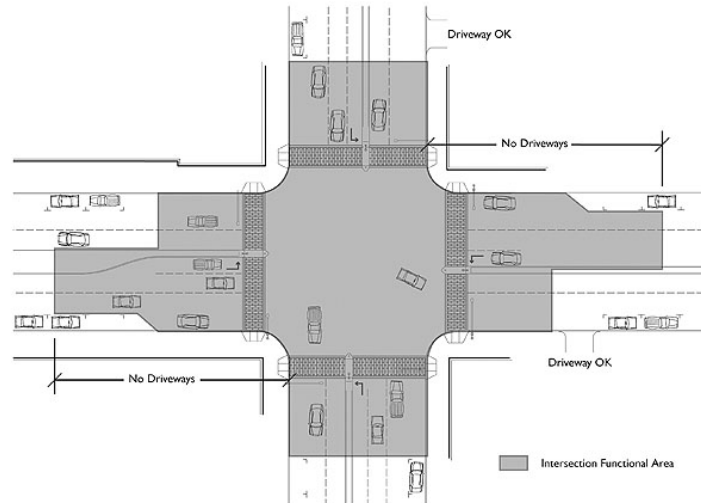

Exhibit 4-1. Intersection functional boundaries.

Source: "Intersection Design Guidelines," Institute of Transportation Engineers, <http://www.ite.org/css/online/DWUT10.html>

Geometric design profoundly influences roadway safety; it shapes road user expectations and defines how to proceed through an intersection where many conflicts exist. In addition to safety, geometric design influences the operational performance for all road users. Minimizing impediments, reducing the need for lane changes and merge maneuvers, and minimizing the required distance to traverse an intersection all improve intersection safety and operational efficiency.

All possible road users' (see Chapter 2) needs must be considered to achieve optimal safety and operational levels at an intersection. When road user groups' design objectives conflict, the practitioner must carefully examine the needs of each user, identify the tradeoffs associated with each element of geometric design, and make decisions with all road user groups in mind. For instance, practitioners may design corner radii to accommodate large vehicles. However, these larger radii would be detrimental to pedestrian safety due to the increase in walking distances and the increase in speed of turning vehicles. Exhibit 4-2 shows a typical example of this situation.



Exhibit 4-2. A large corner radius that impacts pedestrian safety.

Source: PBIC Image Library, Dan Burden

This chapter addresses the following topics:

- Number of intersection approaches.
- Principles of channelization.
- Horizontal and vertical alignment.
- Corner return radius access control.

- Sight distances.
- Pedestrian treatments.
- Curb ramp design.
- Detectable warnings.
- Bicycle facilities.
- Transit facilities.

4.1 NUMBER OF INTERSECTION LEGS

The complexity of an intersection increases as the number of approach legs to the intersection increases. Exhibit 4-3, below, shows the number and type of conflicts that occur at intersections with three and four legs, respectively. Exhibit 4-4 shows a complex intersection with six approach legs. The number of potential conflicts for all users increases substantially at intersections with more than four legs. Note that many potential conflicts, including crossing and merging conflicts, can be managed (but not eliminated) at a signalized intersection by separating conflicts in time.

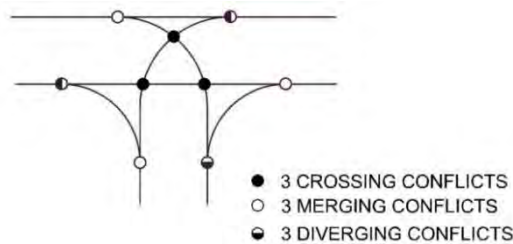

(a) Three-leg intersection.

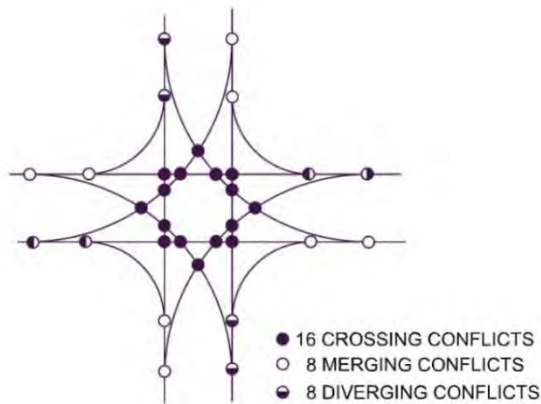

(b) Four-leg intersection.

Exhibit 4-3. Potential conflicts at intersections with three and four legs.



Exhibit 4-4. Photograph of a six-leg intersection.
Source: Google 2012

4.2 CHANNELIZATION

A primary goal of intersection design is to limit and/or reduce the severity of potential road user conflicts. Basic principles of intersection channelization that can reduce conflicts are described below.⁽⁴⁵⁾

1. **Discourage undesirable movements.** Designers can utilize corner radii, raised medians, or traffic islands to prevent undesirable or wrong-way movements. Examples include:

- Restricting left turns from driveways or minor streets based on safety or operational concerns.
- Designing channelization to discourage wrong way movements onto freeway ramps, one-way streets, or divided roadways.
- Designing approach alignment to facilitate intuitive movements.

Exhibit 4-5 shows how a raised median can be used to restrict undesirable turn movements within the influence of signalized intersections.



Exhibit 4-5. This raised median restricts left-turn egress movements from a driveway located between two intersections.

Source: Google 2012

2. **Define desirable paths for vehicles.** The approach alignment to an intersection as well as the intersection itself should present the roadway user with a clear definition of the proper vehicle path. This is especially important at locations with complex geometry or traffic patterns such as highly skewed intersections, multi-leg intersections, offset-T intersections, and intersections with very high turn volumes. Clear definition of vehicle paths can minimize lane changing and avoid “trapping” vehicles in the incorrect lane. Avoiding these undesirable effects can improve both safety and traffic flow at an intersection. Exhibit 4-6 shows how pavement markings can be applied to delineate travel paths.



Exhibit 4-6. Single point urban intersection (SPUI) with pavement marking delineation for turning movements.

Source: Google 2012

3. **Encourage safe speeds through design.** Effective intersection design promotes desirable speeds to optimize intersection safety. The appropriate speed will vary based on the use, type, and location of the intersection. On high-speed roadways with no pedestrians, practitioners may want to promote higher speeds for turning vehicles to remove turning vehicles from the through traffic stream as quickly and safely as possible. This can be accomplished with longer, smooth tapers and larger corner radii. On low-speed roadways or in areas with pedestrians, practitioners may want to promote lower turning speeds. This can be accomplished with smaller turning radii, narrower lanes, and/or channelization features. These are illustrated in Exhibit 4-7.

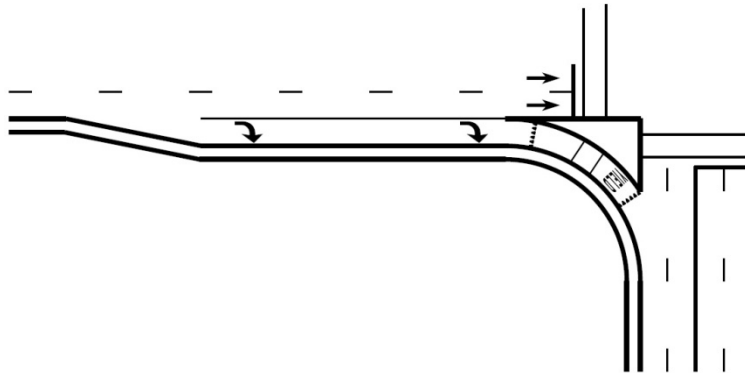

(a) Higher speed design

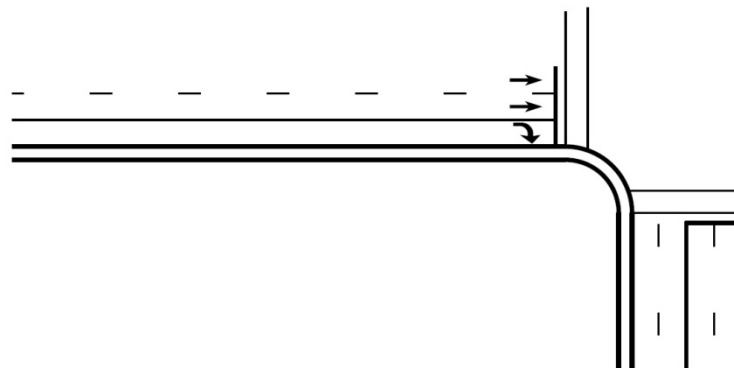

(b) Lower speed design

Exhibit 4-7. Various right-turn treatments may be used, depending on the speed environment.

Chapter 11 contains information pertaining to individual movements such as right- and left-turn lanes, including details concerning storage, multiple turn lanes, and warrants.

4. **Separate points of conflict where possible.** Separation of conflict points can ease the driving task while improving both the capacity and safety at an intersection. The use of exclusive turn lanes, channelized right turns, and raised medians as part of an access control strategy are all effective ways to separate vehicle conflicts. Exhibit 4-8 illustrates how the addition of a left-turn lane can reduce conflicts with through vehicles traveling in the same direction.

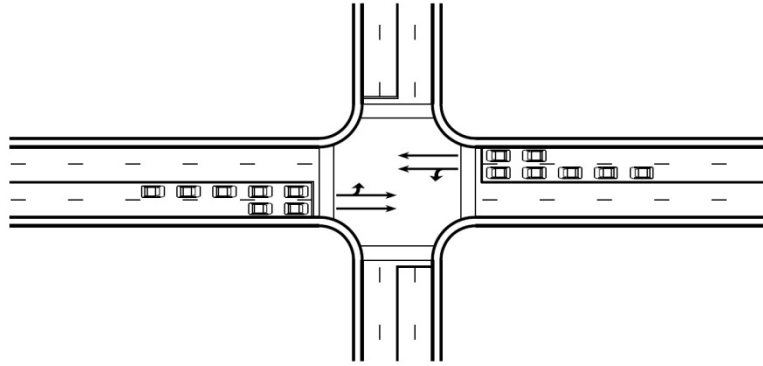

(a) Major street with shared left-through lane causes through vehicles to queue behind left-turning vehicles.

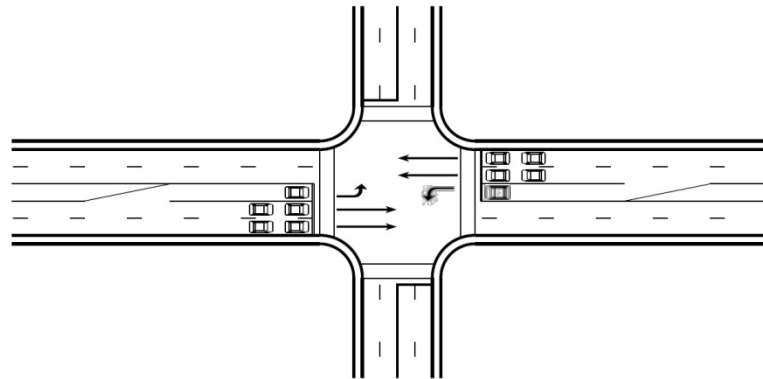

(b) Major street with dedicated left-turn lane removes left-turning vehicles from the paths of through vehicles.

Exhibit 4-8. Providing a dedicated left-turn lane reduces potential rear end collisions between left-turning and through vehicles, increasing the capacity of the approach for both left and through traffic.

5. Facilitate the movement of high-priority traffic flows. Accommodating high-priority movements at intersections addresses both drivers' expectations and intersection capacity. The highest movement volumes at an intersection, define the highest priority movements, although practitioners may also consider route designations and functional classification of intersecting roadways. In low density suburban and rural areas, it may be appropriate to give priority to motor vehicle movements; however, in some urban locations, pedestrians and bicyclists at times may be the highest priority users of the road system. Exhibit 4-9 shows an intersection where double and triple left-turn lanes are used to facilitate high-volume turning movements. Information concerning when these treatments are warranted can be found in Chapter 11.



Exhibit 4-9. The photo shows how double and triple left-turn lanes can be used to accommodate high-priority movements.
Source: Google 2012

6. **Facilitate the desired traffic control scheme.** The signalized intersection design should allow the agency to accommodate changing traffic patterns throughout the life of the intersection. Practitioners should ensure that intersection signs and markings are clearly understood and support correct driver decisions. Other equipment at the intersection should not block sight distance and should facilitate preventive maintenance by field personnel. Practitioners should design for simultaneous left-turning movements and potential u-turning movements. Operational impacts and the design of pedestrian facilities should be taken into account during the intersection's design.

7. **Accommodate decelerating, slow, or stopped vehicles outside higher speed through traffic lanes.** Speed differentials between vehicles in the traffic stream are a primary cause of traffic crashes. Speed differentials at intersections are inherent as vehicles decelerate to facilitate turning. The provision of exclusive left- and right-turn lanes can improve safety by removing slower moving turning vehicles from the higher speed through-traffic stream and reducing potential rear-end conflicts. In addition, through movements may experience lower delay and fewer queues.



Exhibit 4-10. Pedestrian refuge and bicyclist way finding.
Source: Steven Vance, 2010.

8. Provide safe refuge and way finding for bicyclists and pedestrians. Intersection design must consider non-motorist roadway users' needs. Intersection channelization can provide refuge and/or reduce the exposure distance for pedestrians and bicyclists within an intersection without limiting vehicle movement. Practitioners should also consider using raised medians, traffic islands, and other pedestrian-friendly treatments during the design process. Way finding may also be an issue, particularly at intersections with complicated configurations. Practitioners can address this through pavement marking and signing, as shown in Exhibit 4-10.

In locations where the horizontal or vertical alignment obscures raised or flush channelization or markings, practitioners may need to extend the limits of channelization or use other methods to call the attention of road users. For example, should the limits of raised channelization begin at the crest of a vertical curve, it should be extended to give motorists ample time to perceive and react to its presence. In an instance where a right-turn lane taper begins within the outside of a horizontal curve, the channelization or marking may be slightly exaggerated to indicate the presence of the tapered area.

4.3 HORIZONTAL AND VERTICAL ALIGNMENT

The approach to a signalized intersection should promote awareness of the intersection by providing the required stopping sight distance in advance of the intersection. This area is critical as the approaching driver or bicyclist begins to focus on the tasks associated with navigating the intersection.

Drivers' or bicyclists' expectations on approaches to an intersection could be violated under the following conditions, and mitigation efforts should be considered:

- Approach grades to an intersection of greater than 3 percent.
- Intersections located along a horizontal curve of the intersecting road.
- Intersection tables (including sidewalks) with a cross slope exceeding 2 percent.

The angle of the intersection of two roadways can influence both the safety and operational characteristics of an intersection. Heavily angled intersections not only affect the nature of conflicts, but they produce larger, open pavement areas that can be difficult for drivers to navigate and pedestrians to cross. Such large intersections can also be more costly to build and maintain.

Undesirable operational and safety characteristics of skewed intersections include:

- Difficulty accommodating large vehicle turns. Additional pavement, channelization, and right-of-way may be required. The increased pavement area poses potential drainage problems and gives smaller vehicles more opportunity to "wander" from the proper path. Enhanced pavement marking or color-treated pavement can sometimes address this issue.
- Vehicles crossing the intersection are more exposed to conflicts. This requires longer change and clearance intervals and increased lost time, which reduces the capacity of the intersection.
- Longer pedestrian and bicyclist exposure to vehicular traffic. Longer pedestrian intervals may be required, which may have a negative impact on the intersection's capacity.
- Pedestrians with visual disabilities may have difficulty finding their way to the other side of the street when crossing.
- Driver confusion may be more likely at skewed crossings. Woodson, Tillman, and Tillman found that drivers are more positive in their sense of direction when roadways are at right angles to each other.⁽⁴⁶⁾ Conversely, drivers become more confused as they traverse curved or angled streets.

Angled intersections tend to have more frequent right-angle type crashes associated with poor sight distance. AASHTO policy and many State design standards permit angled intersections between 60 to 90 degrees.⁽³⁾ NCHRP Report 500, Volume 12 (Signalized Intersections) recommends 75 degrees or greater to avoid the issues related older drivers, turning right on red, and judging gaps for left-turn maneuvers.

Gattis and Low conducted research to identify constraints on the angle of a left-skewed intersection as it is affected by a vehicle body limiting a driver's line-of-sight to the right.⁽⁴⁷⁾ Their findings suggest that if roadway engineers are to consider the limitations created by vehicle design, a minimum intersection angle of 70 to 75 degrees will offer an improved line-of-sight. FHWA's *Highway Design Handbook for Older Drivers and Pedestrians* recommends intersection angles of 90 degrees for new intersections where right-of-way is not a constraint, and angles of not less than 75 degrees for new facilities or redesigns of existing facilities where right-of-way is restricted.⁽¹⁵⁾

Practitioners should strive to design approaches to intersect at or near right angles. Exhibit 4-11 shows how an angled intersection approach can increase the distance to clear the intersection for pedestrians and vehicles.

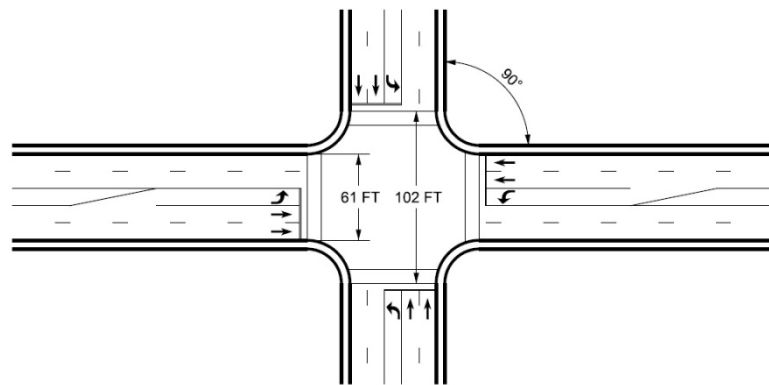

(a) Intersection angle at 90 degrees (i.e., no skew)

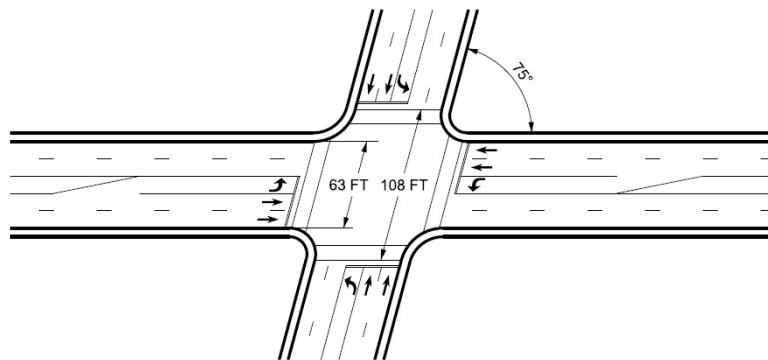

(b) Intersection angle at 75 degrees (i.e., 15-degree skew)

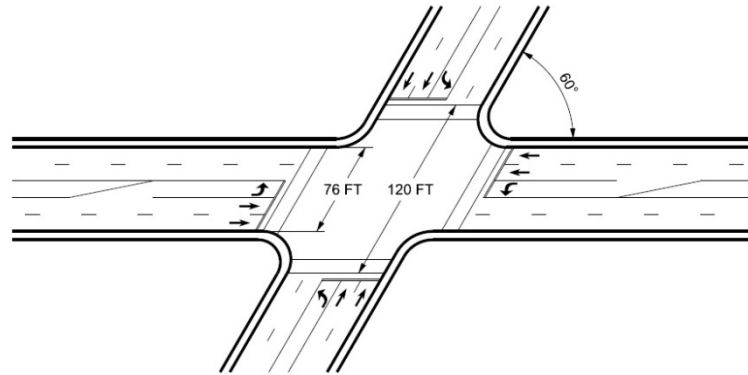

(c) Intersection angle at 60 degrees (i.e., 30-degree skew).

Exhibit 4-11. Intersection angle increases both the intersection width and pedestrian crossing distance.

It should be noted that the intersection angle and intersection skew, by definition, are complimentary angles. The HSM shows that intersection skew is measured from orthogonal, as shown in Exhibit 4-12.

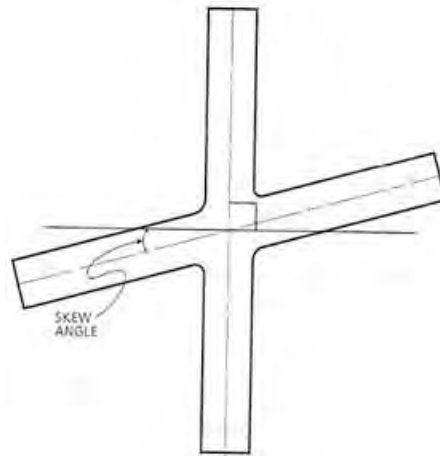

Exhibit 4-12. Intersection skew.

4.4 CORNER RADIUS

Appropriately designed intersection corners accommodate all users. Practitioners should select corner radii and curb ramp design based upon pedestrian crossing and design vehicle needs at the intersection. In general, pedestrian crossings should be as near to perpendicular to the flow of traffic as practical with no intermediate angle points. This keeps pedestrian crossing time and exposure to a minimum, which may allow for more efficient operation of the signal. It also aids visually impaired pedestrians in their way finding task by eliminating changes in direction that may not be detectable.

Practitioners should design corner radii to accommodate the turning path of a design vehicle to avoid encroaching on pedestrian facilities and opposing lanes of travel. Section 4.6.1 addresses curb ramp design in greater detail.

Larger intersection curb radii have disadvantages for pedestrians. Larger radii increase pedestrian crossing distance and the speeds of turning vehicles, creating increased exposure risks. This can be particularly challenging for pedestrians with impaired vision. Large radii also reduce the corner storage space for pedestrians, move pedestrians out of the driver's line of sight, and make it more difficult for pedestrians to see vehicles. On the other hand, smaller radii limit the speeds of turning vehicles and may reduce the operational efficiency of an arterial intersection. A curb that protrudes into the turning radius of the design vehicle can cause vehicles to drive over and damage the curb, as well as increase the potential of hitting a pedestrian standing at the curb.⁽⁴⁸⁾

Factors that influence the selection of appropriate corner radii include the following:

- **Design vehicle.** Selection of a design vehicle should be based on the largest vehicle type that will regularly use an intersection. This can be represented as a standard passenger car, motor home, single-unit truck, bus or semi-trailer. The AASHTO *Green Book* describes representative design vehicles parameters. Practitioners should select an appropriate design vehicle based on the existing and anticipated type of use and the tradeoffs involved with design and spatial impact, and with input from stakeholders and the public. They should select the largest class of vehicle that uses the facility on a regular as the design vehicle. It should represent a cost-effective choice for the project and be appropriate for its context. Use of the facility by the design vehicle should be both a measurable (i.e., over 0.5 percent) and reasonably predictable percentage of the average daily traffic.⁽⁴⁹⁾ Often, agency policy will mandate a design vehicle, regardless of vehicle mix. In certain instances, more than one design vehicle may be appropriate, depending on traffic patterns. There may be instances where it is necessary to consider flush radii instead of raised curbs. By incorporating flush radii, vehicles with large turning radii can be accommodated without modifications to curbed sections. However, not all situations are ideal for flush radii; practitioners should consider the volume and type of non-motorized transportation and locations of intersection infrastructure.
- **Angle of intersection.** Large intersection skew angles necessitate non-matching corner radii, as well as very large or very small radii to accommodate the skew.
- **Pedestrians and bicyclists.** In areas of high pedestrian and bike use, smaller radii are desirable to reduce turning speeds and decrease the distance for pedestrians and bikes to cross the street.
- **Constraints.** Multi-centered curves or simple curves with tangent offsets may better match the turn path of the design vehicle and reduce required right-of-way. Additional pavement may be added to either curbed or flush radii to serve as a truck apron.
- **Encroachment.** A designer must consider whether a turning vehicle's wheel path or swept path should encroach into adjacent lanes (same direction), flush islands that separate traffic, or even into opposing lanes. This concept is important in both right- and left-turn maneuvers. The curb return radii imposed on raised median islands may affect the ability to maintain speed and safely make left turns for motorists leaving or arriving at the approach. Traffic signal infrastructure located within the radius of a right turn maneuver may be damaged due to encroaching vehicles.
- **Intersection size.** Corner radius influences the overall width of the intersection. While larger radii allow for use by vehicles with larger turning radii, it may increase the crossing distance for pedestrians and lengthen overall intersection delay.

4.5 SIGHT DISTANCE

Drivers' ability to see the road ahead and other intersection users is critical to safe and efficient use of all roadway facilities, especially signalized intersections. Stopping sight distance, decision sight distance, and intersection sight distance are particularly important at signalized

intersections. It is imperative that drivers be given sufficient distance to perceive, recognize, and react to the presence of traffic control elements such as traffic signal indications, pavement markings, and signing, in addition to the possibility of queued vehicles and the need to maneuver into auxiliary lanes prior to the intersection.

4.5.1 Stopping Sight Distance

Stopping sight distance is the roadway distance required for a driver to perceive and react to an object in the roadway and to brake to a complete stop before reaching that object. Designers should provide sufficient stopping sight distance to road users throughout the intersection and on each entering and exiting approach. Exhibit 4-13 gives recommended stopping sight distances for design, as computed from the equations provided in the AASHTO policy.⁽³⁾

Exhibit 4-13. Design values for stopping sight distance.

Speed (km/h)	Computed Distance* (m)	Design Distance (m)	Speed (mph)	Computed Distance* (ft)	Design Distance (ft)
20	18.5	20	15	76.7	80
30	31.2	35	20	111.9	115
40	46.2	50	25	151.9	155
50	63.5	65	30	196.7	200
60	83.0	85	35	246.2	250
70	104.9	105	40	300.6	305
80	129.0	130	45	359.8	360
90	155.5	160	50	423.8	425
100	184.2	185	55	492.4	495
110	215.3	220	60	566.0	570
120	248.6	250	65	644.4	645

* Assumes 2.5 s perception-braking time, 11.2 ft/s² (3.4 m/s²) driver deceleration

Source: American Association of State Highway and Transportation Officials (AASHTO). *A Policy on Geometric Design of Highways and Streets*. Washington, DC: AASHTO, 2011.

Practitioners should calculate stopping sight distance using an assumed height of driver's eye of 3.5 ft and an assumed height of object of 2.0 ft.⁽³⁾

4.5.2 Decision Sight Distance

Decision sight distance is “the distance needed for a driver to detect an unexpected or otherwise difficult-to-perceive information source or condition in a roadway environment that may be visually cluttered, recognize the condition or its potential threat, select an appropriate speed and path, and initiate and complete the maneuver safely and efficiently.”^(3, p. 115) Decision sight distance at intersections applies to situations where vehicles must maneuver into a particular lane in advance of the intersection (e.g., alternative intersection designs using indirect left turns).

Decision sight distance varies depending on whether the driver is to come to a complete stop or make some kind of speed, path, or direction change. Decision sight distance also varies depending on the environment—urban, suburban, or rural. Exhibit 4-14 gives recommended values for decision sight distance, as computed from equations in the AASHTO policy.⁽³⁾

Exhibit 4-14. Design values for decision sight distance for selected avoidance maneuvers.

U.S. Customary (ft)					
Speed (mph)	A	B	C	D	E
30	220	490	450	535	620
35	275	590	525	625	720
40	330	690	600	715	825
45	395	800	675	800	930
50	465	910	750	890	1030
55	535	1030	865	980	1135
60	610	1150	990	1125	1280
65	695	1275	1050	1220	1365

Avoidance Maneuver A: Stop on rural road, time (t) = 3.0 s.

Avoidance Maneuver B: Stop on urban road, t = 9.1 s.

Avoidance Maneuver C: Speed/path/direction change on rural road, t = 10.2 s to 11.2 s.

Avoidance Maneuver D: Speed/path/direction change on suburban road, t = 12.1 s to 12.9 s.

Avoidance Maneuver E: Speed/path/direction change on urban road, t = 14.0 s to 14.5 s.

Source: American Association of State Highway and Transportation Officials (AASHTO). *A Policy on Geometric Design of Highways and Streets*. Washington, DC: AASHTO, 2011.

4.5.3 Intersection Sight Distance and Line of Sight

The distance drivers without right-of-way at signalized intersections require to perceive and react to the presence of traffic signal indications, conflicting vehicles, and pedestrians is the intersection sight distance. Horizontal and vertical sight distance must also be maintained such that roadway users have an adequate line-of-sight to traffic control elements as they approach the intersection. Any overhead structure could cause a sight obstruction to nearby traffic signal heads. Practitioners should take care to design the structure and/or modify traffic control devices such that overhead structures do not obstruct approaching road users' view of traffic signals (and other elements like signing). Exhibit 4-15 shows an example where an overhead walkway obstructs the line-of-sight approaching a signalized intersection.



Exhibit 4-15. A pedestrian grade separation treatment restricts sight distance of the traffic signal as motorists approach the intersection.

Source: Synectics Transportation Consultants, Inc.

Practitioners should refer to the *AASHTO Green Book* for a complete discussion of intersection sight distance requirements.⁽³⁾ Intersection sight distance at signalized intersections is generally simpler than at stop-controlled intersections. The following criteria should be met:

- The first vehicle stopped on an approach should be visible to the first driver stopped on each of the other approaches.
- Vehicles making permissive movements (e.g., permissive left turns, right turns on red, etc.) should have sufficient sight distance to select gaps in oncoming traffic.
- Permissive left turns should satisfy the case for left turns from the major road.
- Right turns on red should satisfy the case for a stop-controlled right turn from the minor road.

However, the sight distance needed for stop-controlled intersections should always be maintained for signalized intersections in the event that traffic signals are installed to flash for emergency situations or during instances of power failure where the traffic signal indications are dark.

Intersection sight distance is traditionally measured through the determination of a sight triangle. This triangle is bound by a length of roadway defining a limit away from the intersection on each of the two conflicting approaches and by a line connecting those two limits. Intersection sight distance should be measured using an assumed height of driver's eye of 3.5 ft and an assumed object height of 3.5 ft.⁽³⁾ The area within the triangle is referred to as the sight triangle, and any object at a height above the elevation of the adjacent roadways that would obstruct the driver's view should be removed or lowered, if practical. Such objects may include buildings, parked vehicles, highway structures, roadside hardware, hedges, trees, bushes, un-mowed grass, tall crops, walls, fences, and terrain itself. Exhibit 4-16 illustrates intersection sight distance triangles that should be designed and maintained for all signalized intersections.

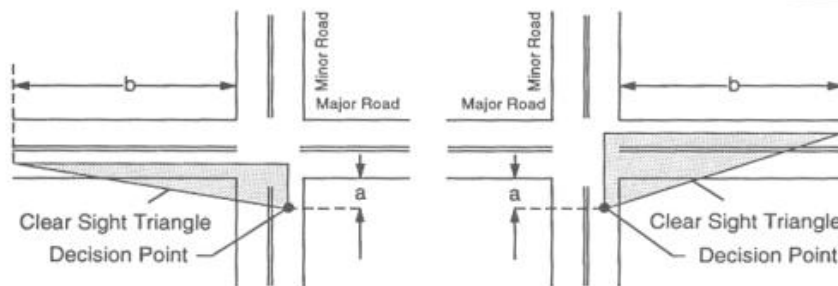

Exhibit 4-16. Intersection sight distance.

Source: Modified from the American Association of State Highway and Transportation Officials (AASHTO) publication *Policy on Geometric Design of Highway and Streets*, 5th Edition, 2004.

4.6 PEDESTRIAN TREATMENTS

It is the policy of the USDOT to “incorporate safe and convenient walking and bicycling facilities into transportation projects,” which is accomplished by working with State and local agencies that receive Federal-aid funding to plan, design and implement these features.⁽¹⁹⁷⁾ Furthermore, in 2008, the FHWA Office of Safety included walkways on its list of Proven Safety Countermeasures, recognizing their significant safety benefits.⁽¹⁹⁸⁾ Therefore, practitioners should provide for pedestrian facilities at all intersections in urban and suburban areas, and at any intersection with known or expected pedestrian activity. This is especially important for signalized intersections, since additional equipment is needed to accommodate pedestrians.

In general, practitioners should design the pedestrian facilities of an intersection with the most challenged users in mind, those pedestrians with mobility or visual impairments. The resulting design will serve all pedestrians well. The *Proposed Accessibility Guidelines for Pedestrian Facilities in the Public Right-of-Way* provides technical requirements and advisory information pertaining to the design, construction, and alteration of facilities such that they are made accessible to and usable by individuals with disabilities. The guidelines take into consideration three laws that require newly constructed and altered facilities to be accessible to individuals with disabilities: the Americans with Disabilities Act, Section 504 of the Rehabilitation Act, and the Architectural Barriers Act.⁽⁵⁴⁾ Therefore, providing pedestrian facilities that are accessible is not merely a matter of best practice, it is also the law.

Pedestrians may face a number of disincentives to walking, including centers and services located far apart, physical barriers and interruptions along pedestrian routes, perceptions that routes are unsafe due to motor vehicle conflicts or crime, and esthetically unpleasing routes.⁽⁵⁰⁾

Certain key elements of pedestrian facilities that practitioners should incorporate into their design are listed and described below.^(Adapted from 51)

- **Pedestrian route.** Ensure the routes and crossings are free of barriers, obstacles, and hazards. Ensure curb ramps, transit stops (where applicable), equipment such as pushbuttons, etc., are well located and meet accessibility standards.
- **Exposure to traffic.** Clearly indicate where crossings should occur and the actions pedestrians are expected to take at crossing locations. Limit exposure to conflicting traffic by minimizing the crossing distance as much as practical, ensure the crosswalk is a direct continuation of the pedestrian's travel path and provide refuges where advantageous.
- **Roadside features.** Provide a separation buffer between the nearest vehicular travel lane and the pedestrian route. Keep corners free of obstructions to provide enough room for pedestrians waiting to cross. Design corner radii to ensure that vehicles do not encroach into pedestrian areas.
- **Visibility and conspicuity.** Strive to design facilities so that pedestrians and traffic are mutually visible by maintaining adequate lines of sight between drivers and pedestrians, especially at crosswalks. When intersection lighting is provided, arrange the lighting to achieve positive contrast of pedestrians.
- **Level of service.** Provide appropriate and regular intervals for crossings and minimize wait time for pedestrians.

4.6.1 Curb Ramp Design

Curb ramps provide access for people who use wheelchairs and scooters. Curb ramps also help people with strollers, luggage, bicycles, and other wheeled objects negotiate the intersection. The basic components of a curb ramp, including ramp, landing, detectable warning, flare, and approach, are diagrammed in Exhibit 4-17. The *Proposed Accessibility Guidelines for Pedestrian Facilities in the Public Right-of-Way* reflects the technical requirements for curb ramps as stated in the ADA and ABA Accessibility Guidelines (ADAAG). The ADAAG requires that curb ramps be provided wherever an pedestrian route crosses a curb, which includes crosswalks at new and retrofitted signalized intersections.⁽³⁶⁾ While curb ramps increase access for mobility-impaired pedestrians, they can decrease access for visually impaired pedestrians by removing the vertical curb face that provides an important tactile cue. This tactile cue is instead provided by a detectable warning surface (DWS) placed at the bottom of the ramp, which provides information on the boundary between the sidewalk and roadway. More information about DWS can be found later in this chapter.

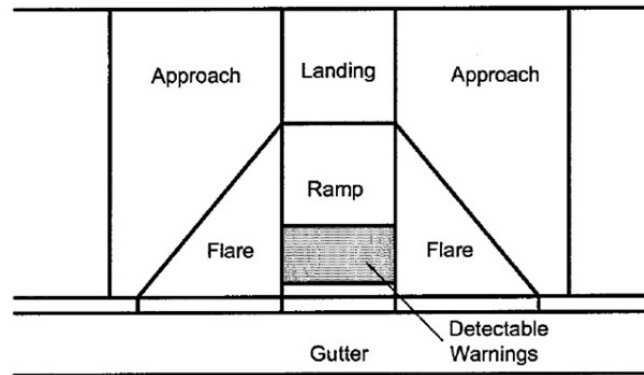
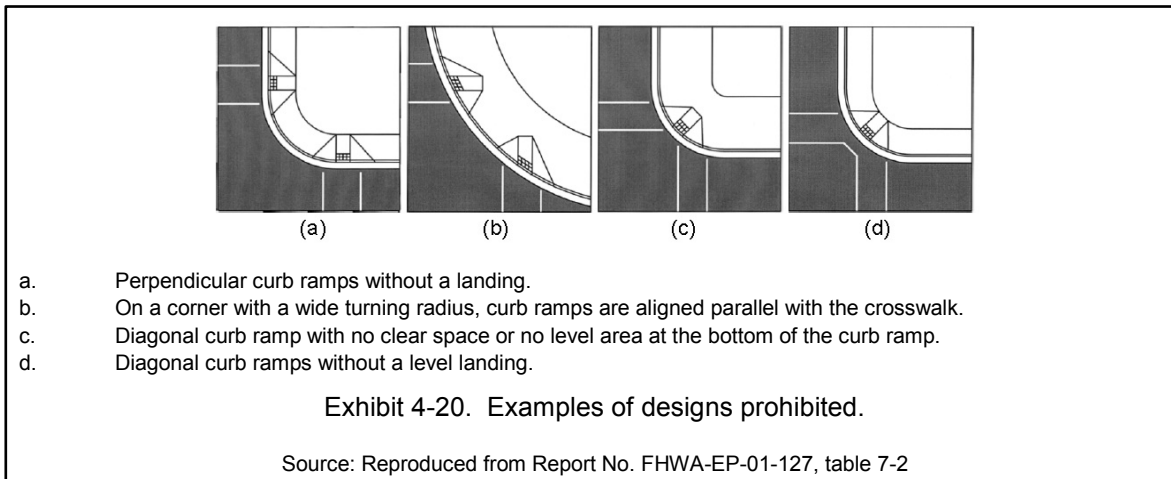
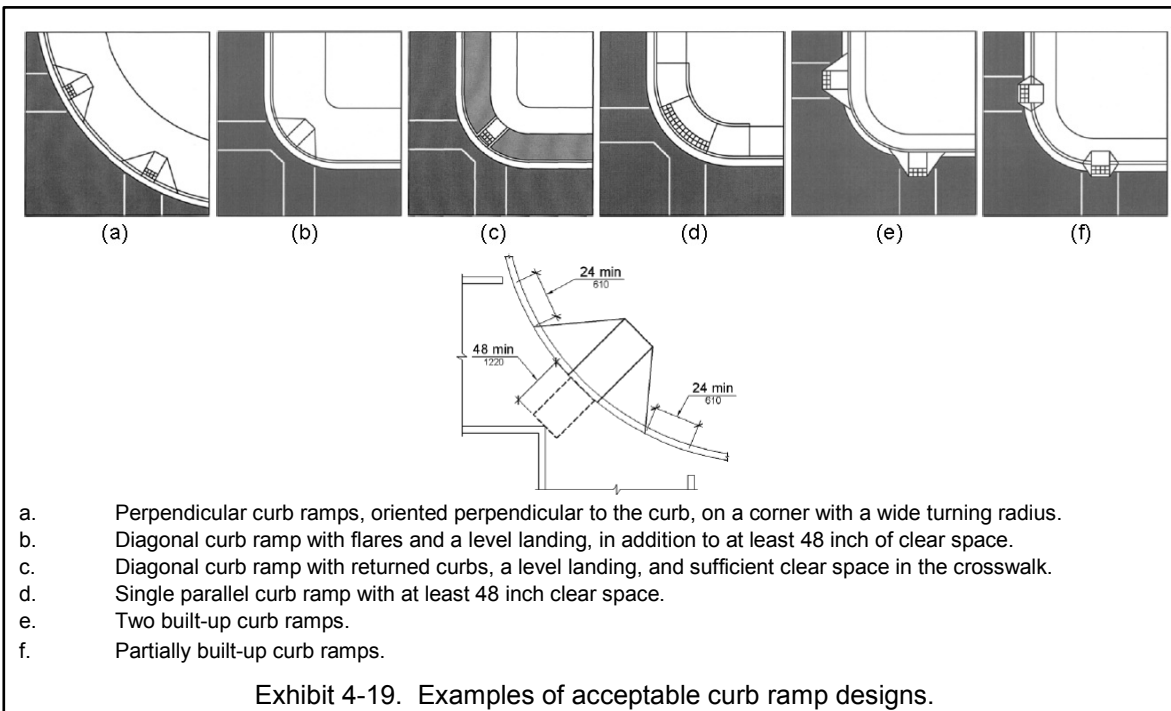
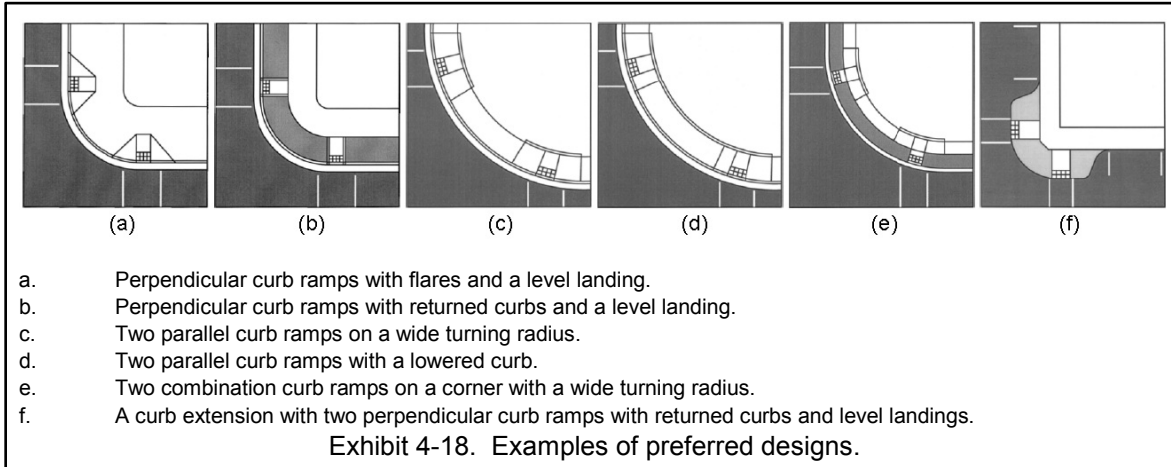

Exhibit 4-17. Curb ramp components

The AADAG provides designers with *Survey Form 4: Curb Ramps* to help in development of accessible curb ramps that meet the requirements of the AADAG, available at <http://www.access-board.gov/adaag/checklist/CurbRamps.html>. Designers may also use FHWA's *Designing Sidewalks and Trails for Access, Part 2: Best Practices Design Guide*, as a source of recommended fundamental practices for curb ramp design, along with the rationale behind each practice.⁽³⁷⁾ A designer can apply these principles in designing intersections in a wide variety of circumstances.

Exhibits 4-18, 4-19, and 4-20 provide examples of three categories of typical curb ramp treatments used at signalized intersections: those that should be implemented wherever possible ("preferred designs"), those that meet minimum accessibility requirements but are not as effective as the preferred treatments ("acceptable designs"), and those that are inaccessible and therefore should not be used in new or retrofit designs ("inaccessible designs"). Additional guidance and design details can be found in the source document.⁽³⁷⁾



4.6.2 Detectable Warning Surfaces

ADAAG and PROWAG require that a detectable warning surface (DWS) be provided at the bottom of curb ramps and within the refuge of any medians and islands (defined in the ADAAG as “hazardous vehicle areas”) to provide tactile cues to individuals with visual impairments so they can determine where the pedestrian route crosses traffic.⁽³³⁾ Detectable warning surfaces consist of a pattern of truncated domes built in or applied to walking surfaces. The domes provide a distinctive surface detectable by cane or underfoot. This surface alerts visually impaired pedestrians of the presence of the vehicular travel way. They also provide physical cues to assist pedestrians in detecting the boundary from sidewalk to street where curb ramps and blended transitions are devoid of other tactile cues typically provided by a curb face.

At the face of a curb ramp and within the refuge area of any median island, a detectable warning surface should be applied, as shown in Exhibit 4-21. The U.S. Access Board and FHWA encourage the use of the design pattern and application found in the 2011 PROWAG.



Exhibit 4-21. This crosswalk design incorporates the use of detectable warning surfaces into the curb ramps to facilitate navigation by a visually impaired pedestrian.

Source: Lee Rodegerdts, 2003

4.7 BICYCLE FACILITIES

Some intersections have on-street bicycle lanes or off-street bicycle paths entering the intersection. When this occurs, intersection design should accommodate the needs of bicyclists in safely navigating such a large and often complicated intersection. Some geometric features that should be considered include:

- Bike lanes and bike lane transitions between through lanes and right-turn lanes. Widths are typically 4 ft when curb and gutter are not present and 5 feet when the lane is adjacent to parking, from the face of the curb or guardrail.⁽²⁶⁾
- Left turn bike lanes.
- Median refuges with a width to accommodate a bicycle: 6 ft = poor; 8 ft = satisfactory; 10 ft = good.^(26, p. 52)

The interaction between motor vehicles and bicyclists at interchanges with merge and diverge areas is especially complex. Some signalized intersections also have merge and diverge areas due to free right turns or diverted movements. AASHTO recommends that “[i]f a bike lane or route must traverse an interchange area, these intersection or conflict points should be designed to limit the conflict areas or to eliminate unnecessary, uncontrolled ramp connections to urban roadways.”⁽²⁶⁾

Figure 9C-4. Example of Bicycle Lane Treatment at a Right Turn Only Lane

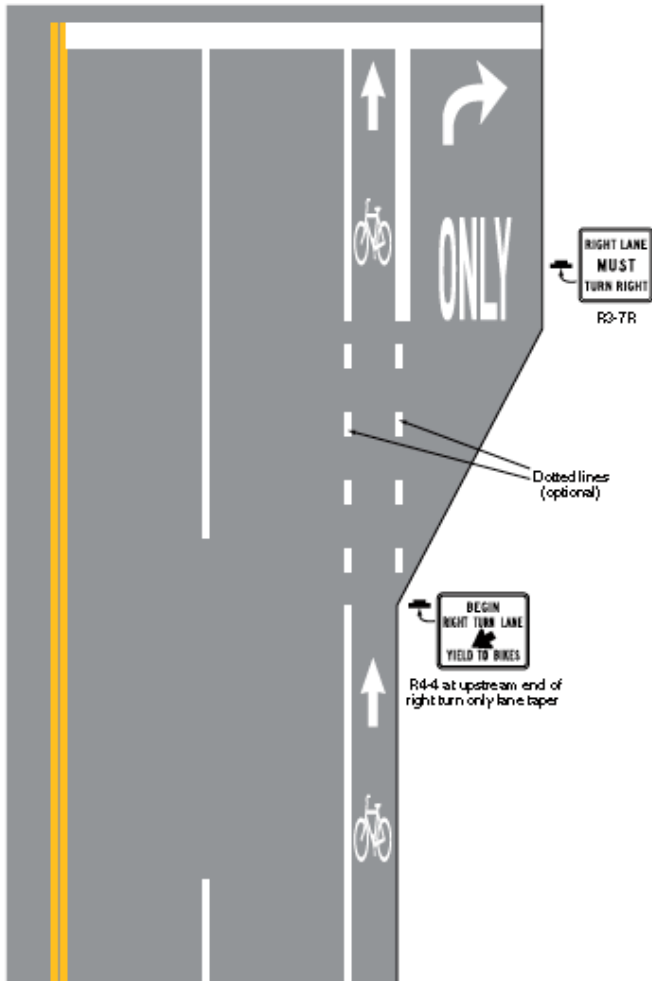

Exhibit 4-22. MUTCD diagram of right-turn lane bicycle accommodation
Source: 2009 MUTCD, Figure 9C-4.

4.8 TRANSIT FACILITIES

Transit facilities near intersections are commonplace in urbanized areas and occur in some rural areas. The placement of the bus stop can impact the safety and operational performance of the intersection. A discussion of transit facilities is included in Section 9.3 of Chapter 9, Intersection-Wide Treatments.



Exhibit 4-23. Transit facility in Santa Barbara, CA
Source: PBIC Image Library, Dan Burden, 2006

CHAPTER 5

TRAFFIC SIGNAL DESIGN AND ILLUMINATION

TABLE OF CONTENTS

5.0	TRAFFIC DESIGN AND ILLUMINATION	5-3
5.1	Traffic Signal Phasing	5-3
5.1.1	“Permissive-Only” Left-Turn Phasing	5-4
5.1.2	“Protected-Only” Left-Turn Phasing	5-6
5.1.3	Protected-Permissive Left-Turn Phasing	5-7
5.1.4	Split Phasing	5-11
5.1.5	Prohibited Left-Turn Movements	5-12
5.1.6	Right-Turn Phasing	5-12
5.2	Vehicle and Pedestrian Displays	5-13
5.2.1	Vehicle Displays	5-13
5.2.2	Pedestrian Displays	5-17
5.2.3	Pedestrian Hybrid Beacons	5-18
5.3	Traffic Signal Pole Layout	5-20
5.4	Traffic Signal Controller and Cabinet	5-21
5.4.1	Physical Location of Equipment	5-21
5.5	Detection Devices	5-22
5.5.1	Vehicle Detection	5-22
5.5.2	Pedestrian Detection	5-24
5.6	Traffic Signal Control Type	5-25
5.7	Basic Signal Timing Parameters	5-25
5.7.1	Vehicle Timing—Green Interval	5-26
5.7.2	Vehicle Timing—Detector Inputs	5-27
5.7.3	Vehicle Timing—Vehicle Clearance	5-29
5.7.4	Pedestrian Timing	5-29
5.7.5	Vehicle Timing—Cycle Length	5-31
5.8	Signing and Pavement Marking Design	5-31
5.9	Illumination Design	5-34
5.9.1	Illuminance	5-35
5.9.2	Veiling Illuminance	5-35

LIST OF EXHIBITS

5-1	Standard NEMA ring-and-barrier structure	5-4
5-2	Typical phasing diagram for “permissive-only” left-turn phasing	5-5
5-3	Possible signal head arrangements for “permissive-only” left-turn phasing	5-6
5-4	Typical phasing diagram for “protected-only” left-turn phasing	5-7
5-5	Possible signal head arrangements for “protected-only” left-turn phasing	5-7
5-6	Typical phasing diagram for protected-permissive left-turn phasing	5-8
5-7	Possible signal head and signing arrangement for protected-permissive left-turn phasing	5-8
5-8	Illustration of the yellow trap	5-10
5-9	Common signal head arrangement for split phasing	5-12
5-10	Typical phasing diagram illustrating a right-turn overlap	5-13
5-11	Examples showing five optional signal head locations	5-15
5-12	Pedestrian signal indications	5-18
5-13	Pedestrian hybrid beacon	5-19
5-14	Sequence for a PHB	5-19
5-15	Advantages and disadvantages of various configurations for displaying vehicle signal indications	5-20

5-16	Location of advanced vehicle detectors	5-23
5-17	Illustration of maximum green functionality	5-27
5-18	Illustration of variable initial feature	5-28
5-19	Pedestrian intervals	5-30
5-20	Example of advance street name sign for two closely spaced intersections.....	5-32
5-21	Example of signing for a left-hand lane drop	5-32
5-22	Example of advance overhead signs and pavement markings indicating lane use for various destinations	5-33
5-23	Example of pavement legends indicating destination route numbers ("horizontal signing").....	5-34
5-24	Recommended illuminance for the intersection of continuously lighted urban streets.....	5-36
5-25	RP-8-00 guidance for roadway and pedestrian/area classification for purposes of determining intersection illumination levels	5-37

5.0 TRAFFIC SIGNAL DESIGN AND ILLUMINATION

This chapter addresses traffic signal hardware and software—the infrastructure that controls the assignment of right-of-way for all intersection users, including vehicles, pedestrians, emergency vehicles, transit operators, trucks, and light-rail transit vehicles at locations where conflicts or hazardous conditions exist. The proper application and design of the traffic signal is a key component in improving the safety and efficiency of the intersection.

This chapter presents an overview of the fundamental principles of traffic signal design and illumination as they apply to signalized intersections. The topics discussed include:

- Traffic signal control types.
- Traffic signal phasing.
- Vehicle and pedestrian detection.
- Traffic signal pole layout.
- Traffic signal controllers.
- Basic signal timing parameters.
- Signing and pavement marking.
- Illumination.

5.1 TRAFFIC SIGNAL PHASING

The MUTCD defines a signal phase as the right-of-way, yellow change, and red clearance intervals in a cycle that are assigned to an independent traffic movement or combination of traffic movements.⁽¹⁾ Signal phasing is the sequence of individual signal phases or combinations of signal phases within a cycle that define the order in which various pedestrian and vehicular movements are assigned the right-of-way. The MUTCD provides rules for determining controller phasing, selecting allowable signal indication combinations for displays on an approach to a traffic control signal, and determining the order in which signal indications can be displayed.

Signal phasing at many intersections in the United States makes use of a standard National Electrical Manufacturers Association (NEMA) ring-and-barrier structure, shown in Exhibit 5-1. This structure organizes phases to prohibit conflicting movements (e.g., eastbound and southbound through movements) from timing concurrently, while allowing non-conflicting movements (e.g., northbound and southbound through movements) to time together. Most signal phasing patterns in use in the United States can be achieved through the selective assignment of phases to the standard NEMA ring-and-barrier structure.

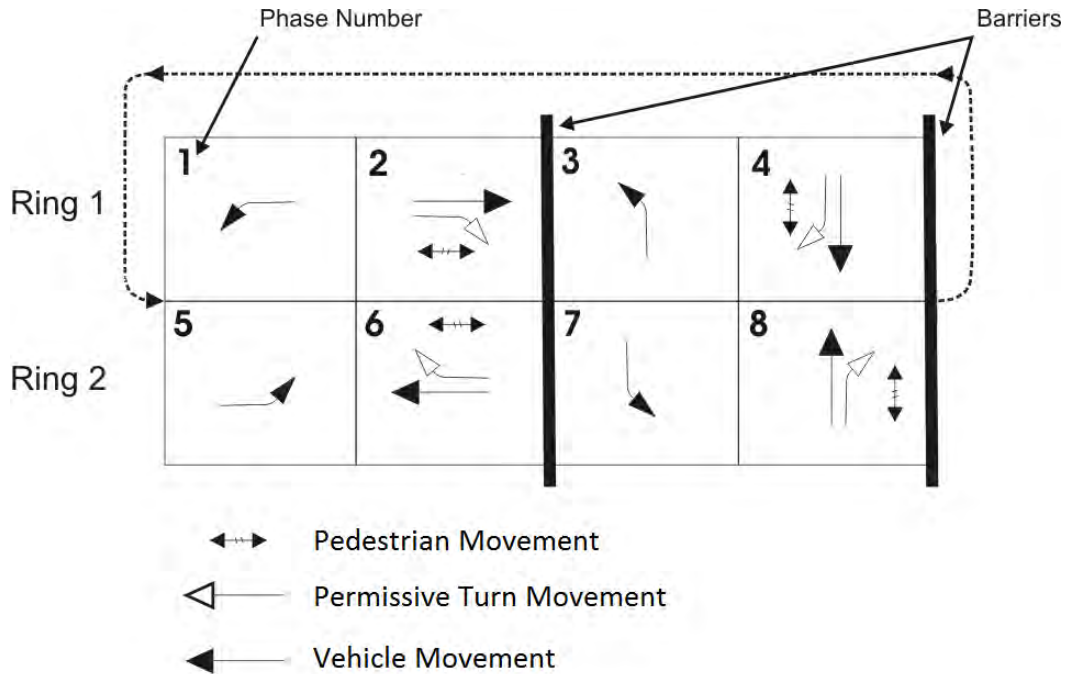

Exhibit 5-1. Standard NEMA ring-and-barrier structure.

Depending on the complexity of the intersection, two to eight phases are typically used, although most controllers provide far more phases to serve complex intersections or sets of intersections. Pedestrian movements are typically assigned to parallel vehicle movements.

Developing an appropriate phasing plan begins with determining the left-turn phase type at the intersection. The most basic form of control for a four-legged intersection is “permissive only” control, which allows drivers to make left turns after yielding to conflicting traffic and pedestrians and provides no special protected interval for left turns. As a general rule, practitioners should keep the number of phases to a minimum because each additional phase in the signal cycle reduces the time available to other phases, and each phase has its own startup delay time.

Provision of a separate left-turn lane, while not required, is recommended when providing a separate left-turn phase. Left-turn lanes increase operational efficiency by providing storage space where vehicles can await an adequate gap without blocking other traffic movements at the intersection. Left-turn lanes also increase the safety of an intersection by reducing rear-end and left-turn crashes. In most cases, the development of a signal phasing plan should involve an engineering analysis of the intersection. Several software packages are suitable for selecting an optimal phasing plan for a given set of geometric and traffic conditions for both individual intersections and for system optimization.

Practitioners must consider all intersection users during the development of a phasing plan, including pedestrians, bicyclists, transit vehicles, older drivers, and children. For example, on wide roadways pedestrian timing may require timing longer than what is required for vehicular traffic, which may have an effect on the operation analysis. The presence of older pedestrians or children may require a longer pedestrian clearance interval based on their slower walking speeds.

5.1.1 “Permissive-Only” Left-Turn Phasing

“Permissive-only” (also called “permitted-only”) phasing allows two opposing approaches to time concurrently, with left turns allowed after motorists yield to conflicting traffic and pedestrians. Exhibit 5-2 illustrates one possible implementation of this phasing pattern. Note that the two

opposing movements could be run in concurrent phases using two rings; for example, the eastbound and westbound through movements shown in Exhibit 5-2 could be assigned as phase 2 and phase 6, respectively.

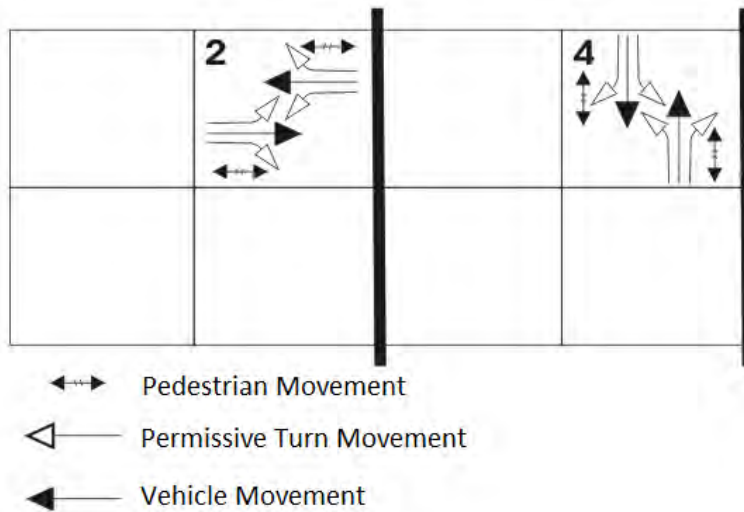

Exhibit 5-2. Typical phasing diagram for “permissive-only” left-turn phasing.

For most high-volume intersections, "permissive-only" left-turn phasing is generally not practical for major street movements because safety will be compromised in such situations, including left-turn safety. Minor side street movements, however, may function acceptably using “permissive-only” left-turn phasing, provided that traffic volumes are low enough to operate efficiently and safely without additional left-turn protection.

“Permissive-only” displays are signified most commonly in one of two ways. In the first case, if there is not an exclusive signal head assigned to a left-turn movement; instead, a three-section head with a circular green, circular yellow, and circular red is used. In this case, no regulatory sign is required.

In the second case, if there is a traffic signal head aligned with an exclusive left-turn lane, a three-section head with a flashing yellow arrow, steady yellow arrow, and steady red arrow is used.

As traffic volumes increase at the intersection, the number of adequate gaps to accommodate left-turning vehicles on the permissive indication may result in safety concerns at the intersection. Exhibit 5-3 shows common signal head arrangements that implement “permissive-only” phasing; refer to the MUTCD for other configurations.

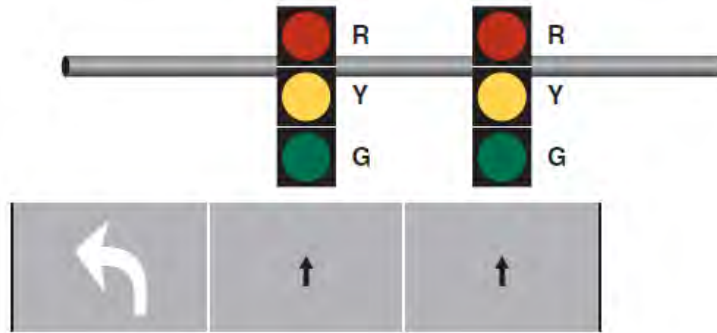

(a) Permissive left-turn phasing using three-section signal heads over the through lanes only.

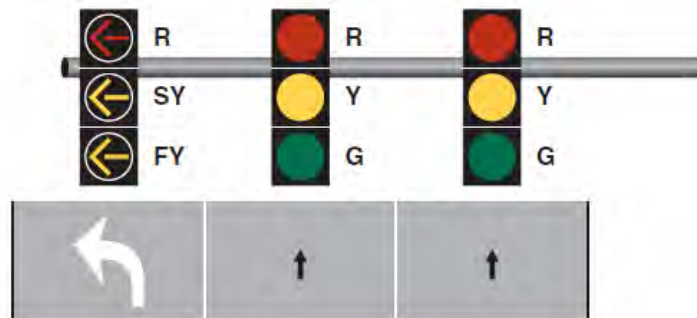

(b) Permissive left-turn phasing using three-section signal heads over the through lanes and a three-section signal head over the left turn lane.

Exhibit 5-3. Possible signal head arrangements for “permissive-only” left-turn phasing
(Source: 2009 MUTCD)

5.1.1 “Protected-Only” Left-Turn Phasing

“Protected-only” phasing consists of providing a separate phase for left-turning traffic and allowing left turns to be made only on a green left arrow signal indication, with no pedestrian movement or vehicular traffic conflicting with the left turn. As a result, left-turn movements with “protected-only” phasing have a higher capacity than those with “permissive-only” phasing due to fewer conflicts. However, under lower volume conditions, this phasing scheme can cause an increase in delay for left-turning drivers. Exhibit 5-4 illustrates this phasing pattern. Typical signal head and associated signing arrangements that implement “protected-only” phasing are shown in Exhibit 5-5; refer to the MUTCD for other configurations. Chapter 11 of this document provides guidance on determining the need for protected left turns.

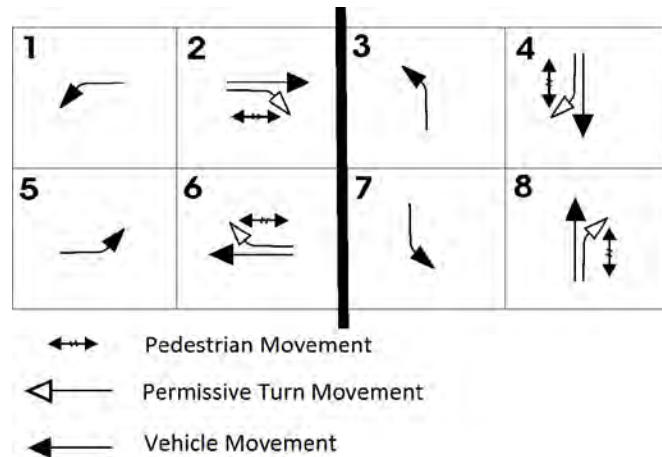

Exhibit 5-4. Typical phasing diagram for “protected-only” left-turn phasing.

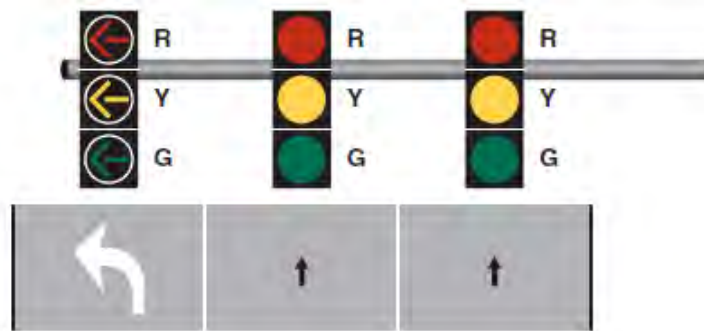

Exhibit 5-5. Possible signal head arrangement for “protected-only” left-turn phasing
(Source: 2009 MUTCD)

5.1.2 Protected-Permissive Left-Turn Phasing

A combination of protected and permissive left-turn phasing is referred to as protected-permissive left-turn (PPLT) operation. Exhibit 5-6 illustrates this phasing pattern. The 2009 MUTCD allows two different signal phasing techniques for this type of operation. The first is when the left-turn lane and the adjacent through lane share the same signal head. Exhibit 5-7(a) shows a typical signal head and associated signing arrangement that implements this type of protected-permissive phasing (refer to the MUTCD for other configurations).

The second phasing technique involves a separate signal head provided exclusively for a left-turn movement. In this case, the flashing yellow arrow is used for the permissive portion of the left-turn movement. Exhibit 5-7(b) shows a typical signal head and associated signing arrangement that implements this type of protected-permissive phasing (refer to the MUTCD for other configurations).

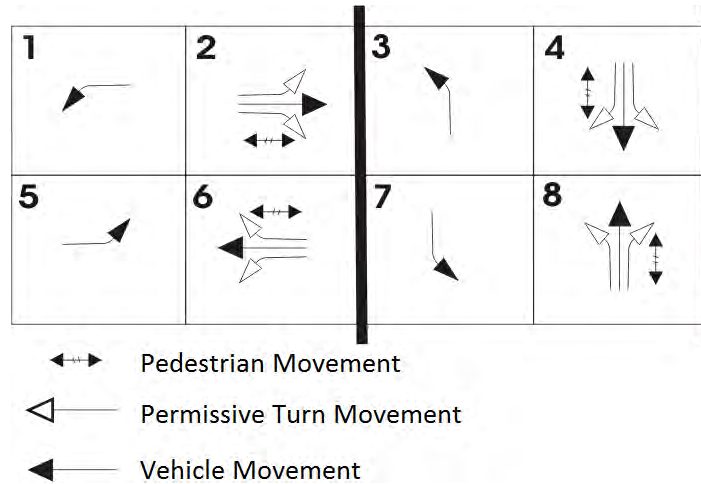
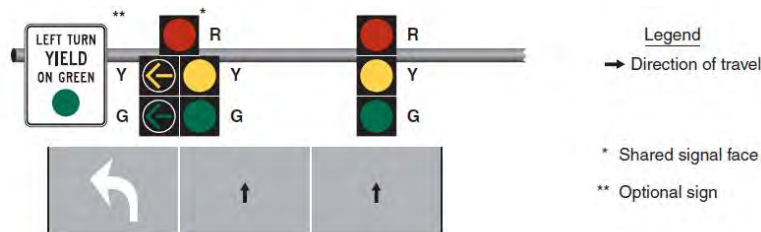
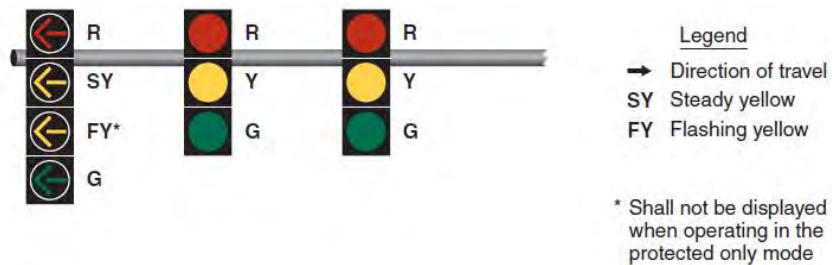

Exhibit 5-6. Typical phasing diagram for protected-permissive left-turn phasing.



(a) Protected-permissive left-turn phasing using a five-section head located directly above the lane line that separates the exclusive through and exclusive left-turn lane, along with an accompanying optional sign.



(b) Protected-permissive left-turn phasing using a five-section signal head located directly above the exclusive left-turn lane.

Exhibit 5-7. Possible signal head and signing arrangement for protected-permissive left-turn phasing.

Source: 2009 MUTCD

Observed improvements in signal progression and efficiency combined with driver acceptance have led to expanded usage of PPLT over the years. PPLT signals offer operational advantages when compared to “protected-only” operation. In protected-permissive phasing, consideration can be given to when in the cycle the protected left-turn movement is given. Where

both protected left-turn movements on opposing approaches operate before the permissive phase, it is known as lead-lead operation. Conversely, where the permissive phases operate before the protected left-turn movements on opposing approaches, it is known as lag-lag operation. Lead-lag operation involves a protected left-turn movement on one approach, while the opposite left-turn movement experiences a permissive left-turn. They include the following (adapted with additions by the authors):⁽⁵⁶⁾

- Average delay per left-turn vehicle is reduced.
- Protected green arrow time is reduced.
- There is potential to omit a protected left-turn phase.
- Arterial progression can be improved, particularly when special signal head treatments are used to allow lead-lag phasing.

The primary disadvantage of the permissive phase is an increased potential for vehicle-vehicle and vehicle-pedestrian conflicts. Younger and older drivers especially have difficulties interpreting the sufficient gap distance need to safety make permissive left turns. The use of permissive phasing also leaves pedestrians without a protected walk phase.

The controller phasing for protected-permissive mode is the most complicated phasing because of the safety implications created by the potential of a “yellow trap” occurring.

For ordinary lead-lead operations where both protected left-turn phases precede the permissive phases, the yellow trap does not occur, as both permissive phases end concurrently. However, this problem can occur when a permissive left turn is opposed by a lagging protected left turn. In this type of operation (known as lag-permissive), the yellow display seen by a left-turning driver is not indicative of the display seen by the opposing through driver. The opposing through display might remain green when the yellow signal indication is displayed to the permissive left-turn movement. A driver who turns left believing that the opposing driver has a yellow or red display when the opposing driver has a green display may be making an unsafe movement. Exhibit 5-8 illustrates this yellow trap.

Drivers who encounter this trap have entered the intersection on a permissive green waiting to make a left turn when sufficient gaps occur in opposing through traffic. If the absence of gaps in opposing through traffic requires them to make their turn during the yellow change or red clearance interval, they may be “stranded” in the intersection because of the absence of gaps and because the opposing through movement remains green. More importantly, they may incorrectly presume that the opposing through traffic is being terminated at the same time that the adjacent through movement is being terminated. Therefore, they may complete their turn believing that the opposing vehicles are slowing to a stop when in fact the opposing vehicles are proceeding into the intersection with a circular green signal indication.

There are options to eliminate the yellow trap situation. The first, and arguably best, option is the flashing yellow arrow operation for the permissive left-turn movement that became allowable with the 2009 MUTCD.

However, there may be circumstances in which that option is not feasible. If that is the case, the phase sequence at the intersection can be restricted to simultaneous leading (lead-lead) or lagging (lag-lag) left-turn phasing. However, it should be noted that under very light side street volumes, the leading left-turn phase can be activated such that it operates like a lagging left turn. This can be prevented using detector switching or a diode in the controller cabinet.

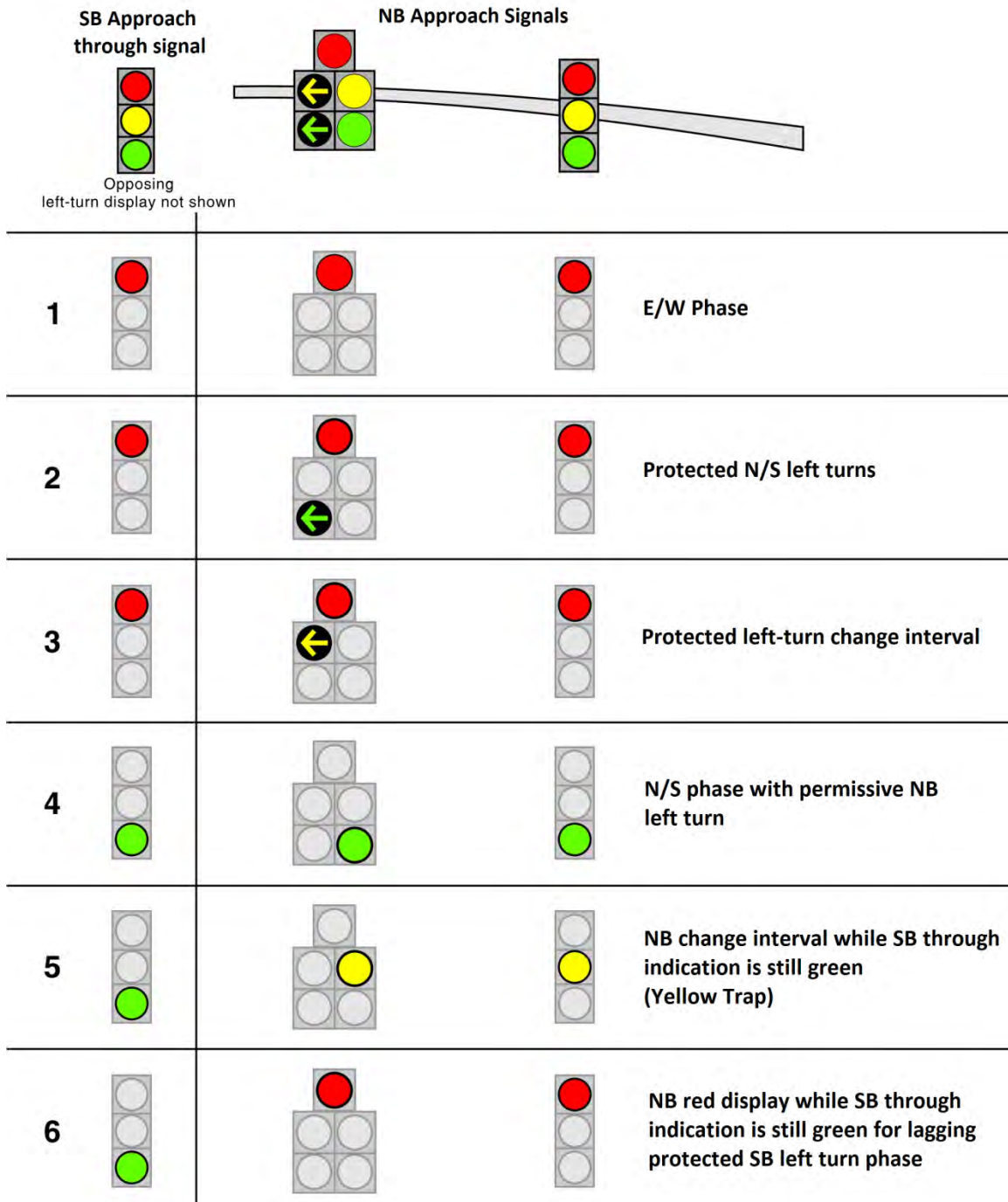

Exhibit 5-8. Illustration of the yellow trap.

5.1.3 Split Phasing

Split phasing consists of having two opposing approaches timed consecutively rather than concurrently (i.e., all movements originating from the west followed by all movements from the east). Split phasing can be implemented in a variety of ways, depending on signal controller capabilities and how pedestrian movements are treated.

Because of the inefficiency of a split phasing operation, it should only be considered after other operational methods or geometric solutions have been considered. In general, a new intersection should not be designed such that split phasing will be required. However, the following conditions could indicate that split phasing might be an appropriate design choice:

- **Multiple Turn Lanes.** There is a need to accommodate multiple turn lanes on an approach, but sufficient width is not available to provide separate lanes. Therefore, a shared through/left lane is required. Practitioners should perform an operational analysis to ensure this option is superior to a single turn lane option under various phasing scenarios.
- **Varied Traffic Volumes.** The left-turn lane volumes on two opposing approaches are approximately equal to the through traffic lane volumes, and the total approach volumes are significantly different on the two approaches. Under these somewhat unusual conditions, split phasing may prove more efficient than conventional phasing.
- **Offset Approach Issues.** A pair of opposing approaches is physically offset such that the opposing left turns could not proceed simultaneously or a permissive left turn could not be expected to yield to the opposing through movement.
- **Geometry.** The geometry of the intersection is such that the paths of opposing left turns would not be forgiving of errant behavior by turning motorists.
- **Crash History.** The safety experience indicates an unusual number of crashes (usually sideswipes or head-on collisions) involving opposing left turns. This may be a result of unusual geometric conditions that impede visibility of opposing traffic.
- **Lane Usage.** A pair of opposing approaches each has only a single lane available to accommodate all movements, and the left turns are heavy enough to require a protected phase.
- **Discrepant Demand.** One of the two opposing approaches has heavy demand and the other has minimal demand. Under this condition, the signal phase for the minimal approach would be skipped frequently and the heavy approach would function essentially as the stem of a T-intersection.

The MUTCD does not provide a standard method for indicating split phasing at an intersection. The methods vary considerably depending on what type of phasing sequence has been used. Exhibit 5-9 shows one way to implement split phasing that does not require the use of additional signs. It involves using a four-section head displaying both a circular green and a green left-turn arrow simultaneously.

However, additional measures are needed when the left-turn arrow would conflict with a concurrent pedestrian phase.⁽⁵⁷⁾

- A special logic package can suppress the green arrow display when serving the pedestrian phase.
- A static sign indicating “LEFT TURN YIELD TO PEDS ON GREEN (symbolic circular green)” located next to the leftmost signal head for emphasis.
- A blankout sign indicating “LEFT TURN YIELD TO PEDS” activated when the conflicting vehicular and pedestrian phases run concurrently.

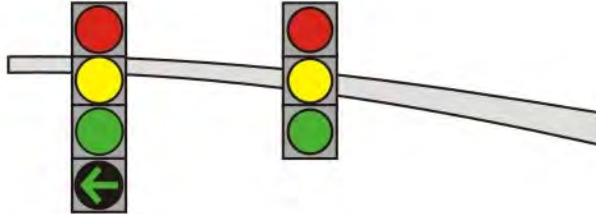

Exhibit 5-9. Common signal head arrangement for split phasing.

5.1.4 Prohibited Left-Turn Movements

Prohibiting left-turn movements at the intersection is an alternative to providing a left-turn phase. Under this scenario, left-turning drivers must divert to another facility or turn in advance of or beyond the intersection via a geometric treatment such as a jug handle or a downstream median U-turn. Left turns can be prohibited on a full- or part-time basis. The amount of traffic diverted, effects on transit routes, the adequacy of the routes likely to be used, and community impacts are all important issues to consider when investigating a turn prohibition. FHWA's Alternative Intersections and Interchanges Informational Report discusses a variety of treatments for redirecting left turns.⁽⁵⁸⁾

5.1.5 Right-Turn Phasing

Practitioners may control right-turn phasing in a permissive or protected manner with different configurations depending on the presence of pedestrians and the lane configurations at the intersections.

Right turns can operate on overlap phases to increase efficiency for the traffic signal. An overlap is a set of outputs associated with two or more phase combinations. As described earlier, practitioners can assign various movements to a particular phase. In some instances, right-turn movements operating in exclusive lanes can be assigned to more than one phase that is not conflicting. In this instance, a right turn is operated at the same time as the left turn, as shown in Exhibit 5-10. The overlap forms a separate movement deriving its operation from its assigned phases (also called parent phases); for example, overlap A (OL A) is typically assigned to phase 2 (the adjacent through phase) and phase 3 (the non-conflicting left-turn phase from the cross street).

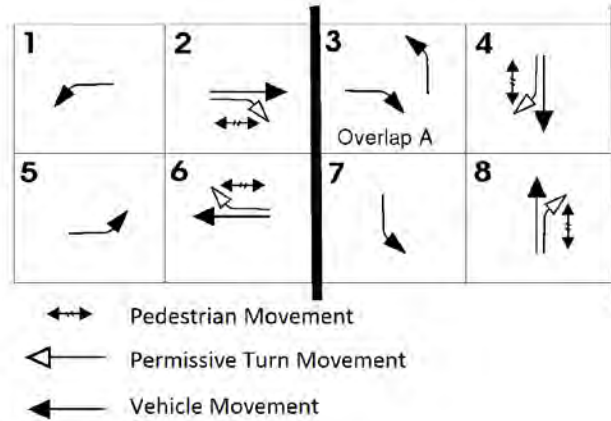

Exhibit 5-10. Typical phasing diagram illustrating a right-turn overlap.

A five-section head with a combination of circular and arrow indications is more commonly used. Note that the MUTCD requires the display of a yellow change interval between the display of a green right-turn arrow and a following circular green display that applies to the continuing right-turn movement on a permissive basis. This yellow change interval is necessary to convey the change in right-of-way from fully protected during the green arrow to requiring a yield to pedestrians and other vehicles during the circular green. This can be implemented by assigning the right-turn arrows to the same phase as the non-conflicting left-turn phase on the cross street and the circular indications to the same phase as the adjacent through movement. With the introduction of the flashing yellow arrow, there are numerous possibilities for signaling a right-turn overlap phase. Refer to MUTCD Sections 4D.22 through 4D.24.⁽¹⁾

This type of operation increases efficiency by providing more green time to this right-turn movement, but may compromise the intersection's usability for visually impaired pedestrians. The transition from the protected right-turn movement on the green arrow to the permissive right-turn movement on the circular green masks the sound of the adjacent through vehicles. This makes it difficult for visually impaired pedestrians to hear when the adjacent through vehicles begin to move, which is used as an audible cue for crossing the street. Therefore, the use of accessible pedestrian signals to provide an audible indication of the start of the pedestrian phase may be needed to restore this cue.

Practitioners should note that a right-turn overlap may conflict with drivers making a legal U-turn on the concurrent (and protected) left-turn phase (in other words, both drivers are facing a green arrow for their movement). This conflict can be resolved by either prohibiting drivers from making a U-turn (R3-4, Sec. 2B.18) on that approach or by installing a U-TURN YIELD TO RIGHT TURN sign (R10-16, Sec. 2B.53) near the left-turn signal face.

5.2 VEHICLE AND PEDESTRIAN DISPLAYS

Signal displays can be generally categorized into those for vehicles and those for pedestrians. The following sections discuss each type.

5.2.1 Vehicle Displays

Practitioners should evaluate the location of signal heads based on visibility requirements and type of signal display. While MUTCD requirements govern signal head placement for signal displays (discussed in the previous section), local policies typically determine the specific signal head placement.

When designing signal head placement, practitioners should consider the following in addition to the minimum requirements described in the MUTCD:

- Consistency with other intersections in the area.
- Geometric design issues that could confuse a driver.
- A high percentage of vehicles on one or more approaches that block lines of sight, including trucks and vans.
- The width of the intersection.
- The turning paths of the vehicles.

The 2009 MUTCD recommends that on high-speed approaches (85th percentile greater than 45 mph) or on approaches with three or more through lanes that the primary number of signal displays equal the number of through lanes. These signal displays should be installed over the center of each lane. With the advent of light emitting diode (LED) signal displays, the power requirements for additional signal displays is not significant.

At large signalized intersections, the use of additional signal heads may enhance the safety and operation of the intersection. Exhibit 5-11 shows a typical intersection design with five types of optional heads:

Optional Head #1: A near-right-side head that provides an advanced head at wide intersections as well as a supplemental head for road users unable to see the signal heads over the lanes due to their position behind large vehicles (trucks, etc.).

Optional Head #2: An extra through head that supplements the overhead signal heads. This head provides an indication for vehicles that might be behind large vehicles and may be more visible than the overhead signal head when the sun is near the horizon.

Optional Head #3: An extra left-turn head that guides left-turning vehicles across a wide intersection as they turn. It also improves visibility for vehicles behind large vehicles and for times of day when the sun nears the horizon.

Optional Head #4: A near-left-side head that provides an advance indication a curve in the road upstream of the intersection hampers visibility.

Optional Head #5: This head provides a display in direct view of a right-turn lane and provides a right-turn overlap phase in conjunction with the non-conflicting left-turn phase on the cross street. The head should contain either three circular indications or be a five-section head with three circular indications and two right-turn arrows due to the concurrent pedestrian crossing.

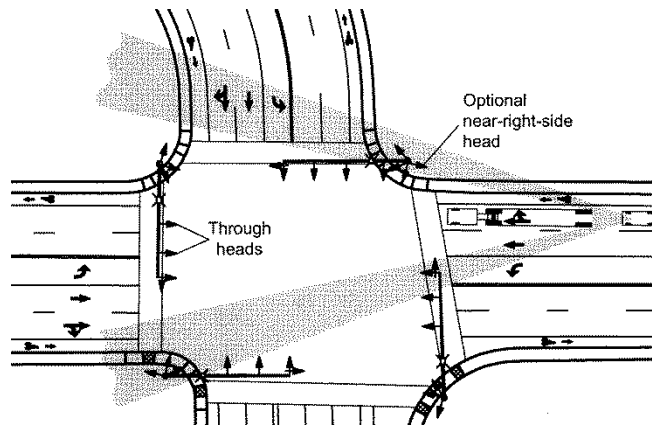

(a) Optional Head #1: Near-side head for through vehicles.

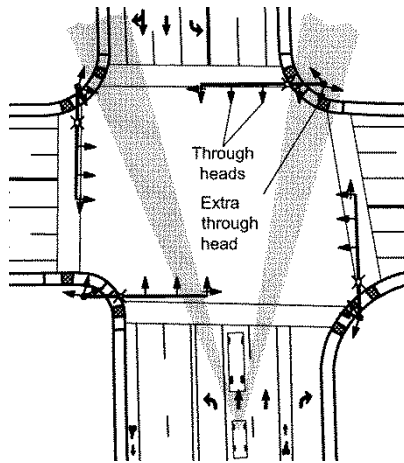

(b) Optional Head #2: Far-side supplemental head for through vehicles.

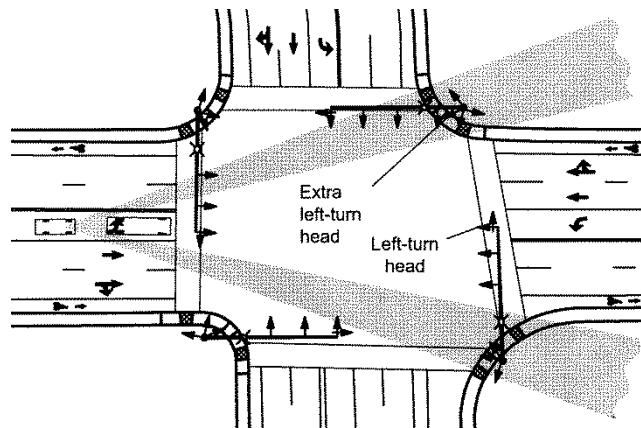

(c) Optional Head #3: Far-side supplemental head for left-turning vehicles.

Exhibit 5-11. Examples showing five optional signal head locations.

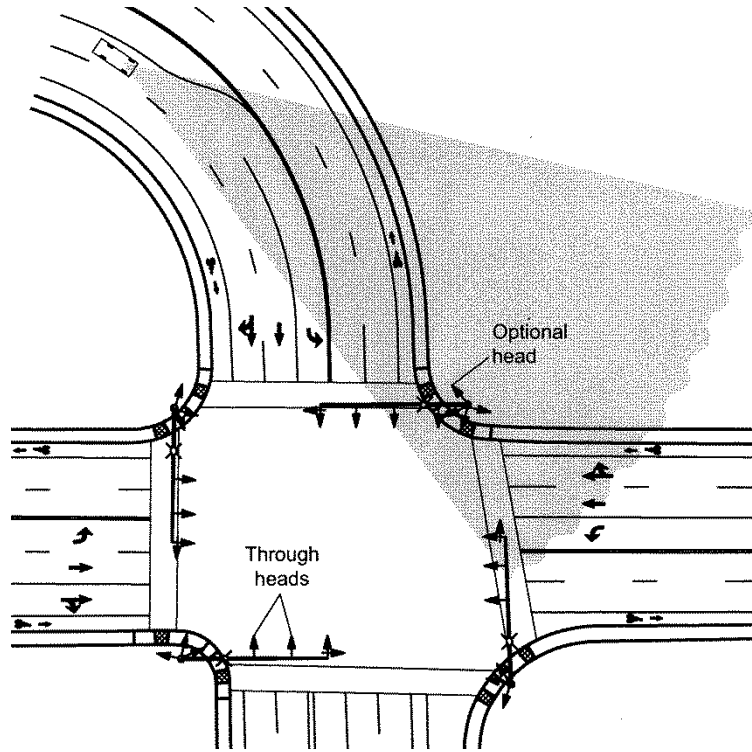

(d) Optional Head #4: Near-side head on curving approach.

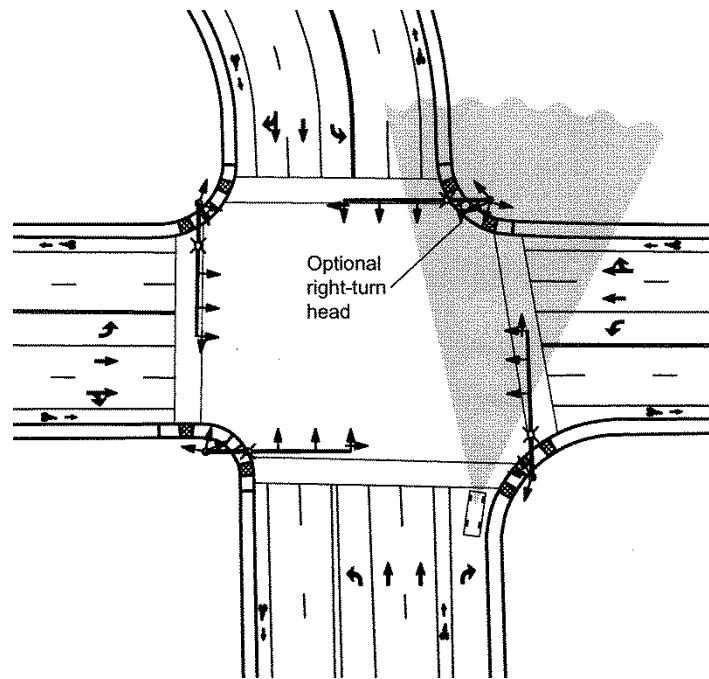

(e) Optional Head #5: Far-side head for right-turning vehicles.

Exhibit 5-11 (cont'd). Examples showing five optional signal head locations.

5.2.2 Pedestrian Displays

According to section 4E.03 of the 2009 MUTCD, pedestrian signal heads shall be used in conjunction with vehicular traffic control signals under any of the following conditions:⁽¹⁾

- If a traffic control signal is justified by an engineering study and meets Warrant 4, Pedestrian Volume, or Warrant 5, School Crossing (see MUTCD Chapter 4C).
- If an exclusive signal phase is provided or made available for pedestrian movements in one or more directions, with all conflicting vehicular movements being stopped.
- At an established school crossing at any signalized location.
- Where engineering judgment determines that multiphase signal indications (as with split-phase timing) would tend to confuse or cause conflicts with pedestrians using a crosswalk guided only by vehicular signal indications.

Pedestrian signals should be used under the following conditions:

- If it is necessary to assist pedestrians in making a reasonably safe crossing or if engineering judgment determines that pedestrian signal heads are justified to minimize vehicle-pedestrian conflicts.
- If pedestrians are permitted to cross a portion of a street – such as to or from a median of sufficient width for pedestrians to wait – during a particular interval but are not permitted to cross the remainder of the street during any part of the same interval.
- If no vehicular signal indications are visible to pedestrians, or if the vehicular signal indications that are visible to pedestrians starting or continuing a crossing provide insufficient guidance for them to decide when it is reasonably safe to cross, such as on one-way streets, at T-intersections, or at multiphase signal operations.

The MUTCD provides specific guidance on the type and size of pedestrian signal indications (Section 4E.04). As noted in the MUTCD, all new pedestrian signals shall use the UPRAISED HAND (symbolizing DON'T WALK) and WALKING PERSON (symbolizing WALK) indications, shown in Exhibit 5-12. The pedestrian displays shall be mounted so that the bottom of the pedestrian signal display housing (including mounting brackets) is no less than 7 ft and no more than 10 ft above sidewalk level.⁽¹⁾

The 2009 MUTCD approves the use of pedestrian countdown displays. The countdown displays the number of seconds remaining in the pedestrian change interval. Section 4E.07 of the MUTCD requires them to be used on all crosswalks where the pedestrian change interval is more than 7 seconds.

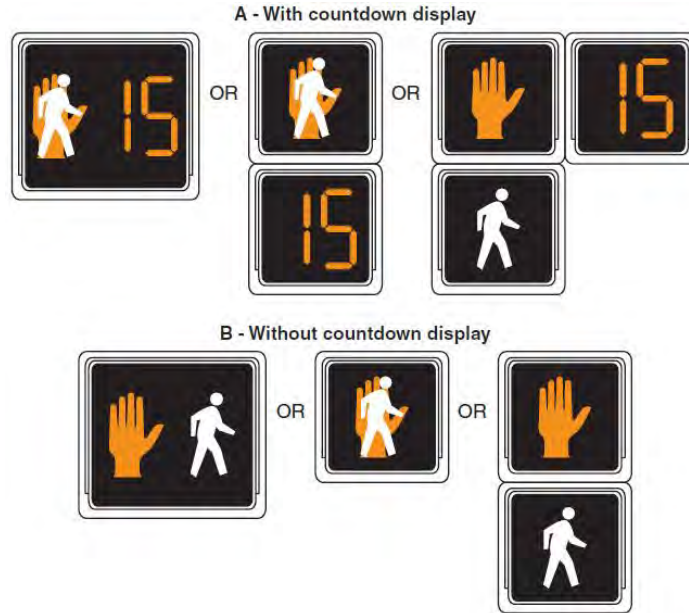

Exhibit 5-12. Pedestrian signal indications.
Source: 2009 MUTCD

Some signalized intersections have factors that may make them difficult for pedestrians who have visual disabilities to cross safely and effectively. As noted in the MUTCD (Section 4E.09), these factors include:⁽¹⁾

- Increasingly quiet cars.
- Right-turn overlaps (which mask the sound of the beginning of the through phase).
- Continuous right-turn movements.
- Complex signal operations (e.g., protected-permissive phasing, lead-lag phasing, or atypical phasing sequences).
- Wide streets.
- Unusual intersection geometrics.

To address these challenges, accessible pedestrian signals have been developed to provide information to the pedestrian in a nonvisual format, such as audible tones, verbal messages, and/or vibrating surfaces. Details on these treatments can be found in the MUTCD⁽¹⁾ and in several references sponsored by the U.S. Access Board and the National Cooperative Highway Research Program (NCHRP).^{(59), (60), (61)}

5.2.3 Pedestrian Hybrid Beacons

The 2009 edition of the MUTCD approved the optional use of pedestrian hybrid beacons (PHB) as a traffic control device. A pedestrian hybrid beacon is a special type of traffic control device used to warn and control traffic at an unsignalized location to assist pedestrians in crossing a street or highway at a marked crosswalk. Chapter 4F of the MUTCD describes the design and operation of these devices in more detail. The PHB in the MUTCD is based on a design previously known as a HAWK signal, developed in Tucson, Arizona.



Exhibit 5-13. Pedestrian hybrid beacon.
Source: FHWA Office of Safety

Although the PHB has been technically defined as a beacon and not a traffic signal, it may still require enabling legislation, which depends directly on a given State's laws concerning signals and what motorists are expected to do when approaching a "dark" signal. Many States require drivers to come to a full and complete stop at a dark signal. The presumption is that in this case, there has been a power outage at the intersection. However, in most States, a dark beacon does not require a motorist to stop, nor would a dark PHB.

The sequence of the PHB is illustrated in Exhibit 5-15.

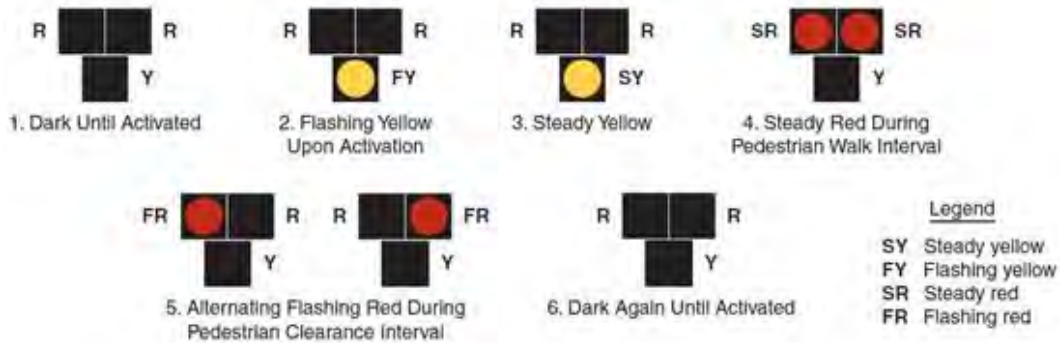

Exhibit 5-14. Sequence for a PHB.
Source: 2009 MUTCD

5.3 TRAFFIC SIGNAL POLE LAYOUT

Three primary types of signal configurations display vehicle signal indications:

- Mast arms.
- Span-wire configurations. Box span-wire design is preferred to diagonal design for new installation.
- Pedestal or post-mounted signal displays.

Exhibit 5-15 identifies the advantages and disadvantages of each configuration.

Advantages	Disadvantages
Mast arm vehicle signal <ul style="list-style-type: none"> • Provides more precise signal head placement • Lower maintenance costs • Many pole esthetic design options 	<ul style="list-style-type: none"> • More costly than span wire • Mast arm lengths can limit use and be extremely costly for some large intersections
Span wire vehicle signal <ul style="list-style-type: none"> • Can accommodate large intersections • Flexibility in signal head placement • Lower initial cost than mast arms 	<ul style="list-style-type: none"> • Higher maintenance costs • Wind and ice can cause problems • May be considered aesthetically unpleasing • Visibility not as good as a mast arm
Pedestal (post-mounted) vehicle signal <ul style="list-style-type: none"> • Low cost • Less impact on view corridors • Lower maintenance costs • Esthetics • Good for supplemental signals 	<ul style="list-style-type: none"> • Difficult to meet MUTCD visibility requirements, particularly at large signalized intersections

Exhibit 5-15. Advantages and disadvantages of various configurations for displaying vehicle signal indications.

In addition to providing support for the optimal location of vehicle and pedestrian signal indications, signal poles need to be located carefully to address the following issues:

- Pedestrian walkway and ramp locations.
- Pedestrian pushbutton locations, unless separate pushbutton pedestals are provided.
- Clearance from the travel way.
- Available right-of-way and/or public easements.
- Overhead utility conflicts, as most power utilities require at least 10 ft clearance to power lines.
- Underground utilities, as most underground utilities are costly to relocate and therefore will impact the location of signal pole foundations.

The MUTCD,⁽¹⁾ the ADAAG,⁽³⁶⁾ and the AASHTO *Roadside Design Guide*⁽⁶²⁾ all contain guidance regarding the lateral placement of signal supports and cabinets. Generally, signal poles should be placed as far away from the curb as practically possible, not conflict with the pedestrian walking paths, and be located for easy access to the pushbuttons by all pedestrians. In some circumstances, it may be difficult or undesirable to locate a single pole that adequately serves both pedestrian ramps and provides adequate clearances. In these cases, one or more pedestals with the pedestrian signal heads and/or pushbuttons should be considered to ensure visibility of the pedestrian signal heads and accessibility to the pushbuttons.

5.4 TRAFFIC SIGNAL CONTROLLER AND CABINET

The traffic controller is the brain of the intersection. Most of the early electro-mechanical controllers have been replaced by solid state controllers across the country. Solid state controllers consist of the NEMA type controllers, Type 170 controllers, ATC Type 2070 controllers, and Advanced ATC controllers. Modern controllers can perform the basic functions needed at typical signalized intersections and have additional capabilities. These include the ability to communicate with other vendor software using standardized communication protocol called National Transportation Communication for ITS Protocol (NTCIP), ability to provide transit priority, control diamond interchanges, etc.

NEMA TS-1 is the first generation of NEMA controllers using discrete solid state electronics interface to the controller field-wiring back panel. TS-1 defines what the controller must do and defines the interface between the controller and the cabinet. Software is built into the controller and is not accessible by others. The newer version, TS-2, is similar to the TS-1 in the way the functionality is defined. However TS-2 specifies a cabinet bus interface unit (BIU) using RS-485 with Synchronous Data Link Control protocol (SDLC) to connect the controller, malfunction management unit (MMU), the detection system, and the back panel. The use of BIU interface reduces the complexity of signal controller cabinet. There are two types of TS-2 controllers. TS-2 Type 1 controller is a pure TS-2 controller whereas TS-2 Type 2 controller can be retrofitted into a TS-1 cabinet.

About the same time the TS-1 specifications were developed, the California Department of Transportation, City of Los Angeles, New York State Department of Transportation, and FHWA developed an open-architecture microcomputer for traffic control. This architecture facilitated the use of software developed by a third party, and the user has access to the software.

The California Department of Transportation led the development of the ATC Type 2070 architecture due to advancements in communications and processors. Model 2070 employs the open-architecture to facilitate the installation of aftermarket processors and other devices in the controllers. The 2070 controller can be placed either in a cabinet for a Type 170 controller or a NEMA controller with the right modules. Like Type 170 controller, software is provided by a third party.

Finally, the Advanced ATC type controller is the second generation of ATC controller with a single-board computer that provides a standard physical and electrical interface to all the other components in the controller.

5.4.1 Physical Location of Equipment

In locating the controller cabinet, consider the following:

- It should not interfere with sight lines for pedestrians or right-turning vehicles.
- It should be in a location less likely to be struck by an errant vehicle and not impeding pedestrian circulation, including wheelchairs and other devices that assist mobility.
- A technician at the cabinet should be able to see the signal indications for two approaches while standing at the cabinet.
- The cabinet should be located near the power source.
- The cabinet location should afford ready access by operations and maintenance personnel, including consideration for where personnel would park their vehicle.

5.5 DETECTION DEVICES

The detectors (or sensors) inform the signal controller of the presence, movement and/or occupancy of motor vehicles, pedestrians, or bicycles at a defined location: the upstream approach to, or downstream side of, an intersection. The signal controller can then use this information to perform its functions, such as allocate the amount of green time, select timing plans, and order signal phases.

5.5.1 Vehicle Detection

Vehicle detectors typically function as presence, pulse (advanced), or system (data). A detector may have more than one function. The detector location, relative to the intersection, often indicates its primary function: presence detectors are located in close proximity to the stop line; pulse detectors are located upstream, well in advance of the intersection; and system detectors are typically located midblock or just downstream of the intersection.

- *Presence* detectors alert the controller to waiting vehicles during the red interval and calls for additional green time (passage or extension) for moving vehicles during the green interval.
- *Pulse* detectors extend the green signal indication for approaching vehicles. Pulse detectors are often placed on high speed approaches to reduce the risk of motorists encountering a yellow signal indication within the dilemma zone. During the red interval, pulse detection of each vehicle can incrementally adjust green time above the 'minimum green' controller setting to ensure servicing of the developed queue.
- *System* detectors collect data such as speed, volume, occupancy, and/or queue information for the purpose of timing plan selection (when in traffic responsive operation), real-time adaptive control, and timing plan overrides. An example of override activation would be to order a special timing plan to prevent off-ramp, vehicle spillback onto an expressway when the off-ramp, queue detector is occupied.

Detectors are placed either in-roadway or over the roadway surface. The performance of in-roadway detectors such as inductive loops, magnetic, and magnetometer detectors depends upon the quality of the installation, proximity to the vehicle, and the condition of the pavement structure. These detectors are designed to be insensitive to inclement weather but are subject to disruption of service due to pavement milling, utility cuts, and pavement movement. The main disadvantage of in-roadway detection is the disturbance to the roadway surface and exposure of personnel to traffic during installation and maintenance. Over roadway detectors, such as video detection and digital matrix radar, are generally auto-programmable, multi-lane, and multi-functional. Digital matrix radar detectors are insensitive to weather, continuously track vehicles in the zone, and require little maintenance. Factors affecting the performance of video detection are often related to the camera lens and mounting: wind, fog, shadows, occlusion, etc. Newer types of detection feature remote monitoring and troubleshooting. Out of service or unreliable vehicle detection results in unused green time, diminished dilemma zone protection, omitted phases, poor optimization, and driver frustration. The FHWA *Traffic Detector Handbook* includes further discussion on detector technology.

The dilemma zone is that portion of the approach where a driver seeing a yellow indication must make a decision whether to stop safely or to proceed through the intersection. Hence, the minimum stopping distance usually dictates dilemma zone. The actual distances vary by jurisdictional policies. Practitioners should review these policies before designing the traffic signal and detector system. The typical location for advance detectors is based on stopping sight distance, as shown in Exhibit 5-16. The stopping distance can be computed for both the average stopping condition as well as the probability ranges for stopping. For higher speed approaches (45 mph or greater) and to account for the desired probability of stopping, pulse or advanced detection should be used. More detailed information on detector placement, including the results of several calculation methods, can be found in FHWA's *Manual of Traffic Detector Design*.⁽⁵⁸⁾

Exhibit 5-16. Location of advanced vehicle detectors.

Speed	Calculated Stopping Distance	Single Detector Setback	Multiple Detector Setback	
			10% Probability of Stopping	90% Probability of Stopping
20 mph	72.2 ft	70 ft	—	—
25 mph	104.4 ft	105 ft	—	—
30 mph	140.8 ft	140 ft	—	—
35 mph	182.9 ft	185 ft	102 ft	254 ft
40 mph	231.0 ft	230 ft	122 ft	284 ft
45 mph	283.8 ft	*	152 ft	327 ft
50 mph	341.9 ft	*	172 ft	353 ft
55 mph	406.3 ft	*	234 ft	386 ft

* Use multiple detectors or volume-density modules.

Source: Reference 63 (table 4-3); Reference 64 (table 7-1);

Proper settings of the detector equipment can help fine tune operations and safety improvements at a signalized intersection. Both the detection equipment and the traffic signal controller are typically capable of adjusting the outputs from the detector and/or inputs to the controller. A few of the more common programmable features are lock, delay, extend, and switch.

- A **Lock** (Y or N) retains the call placed on the controller during the red signal indication for the phase even though a vehicle moves outside the detection zone. The lock feature is useful on left-turn lanes where a vehicle may creep forward while waiting on the protected left-turn green signal indication.
- A **Delay** (in seconds) can be set on turning lane detection where permissive turns are allowed in order to give vehicles time to select a safe gap to complete their turn, without placing the call to the controller for the protected left turn phase.
- An **Extend** (in seconds) holds the call upon the controller for a defined period of time after the vehicle leaves the zone of detection.
- A **Switch** dynamically changes the assignment of a vehicle detector to a different vehicle phase during a specific portion of the cycle length. For example, a heavy side street volume of left turners might benefit from unused green time from a lighter volume adjacent through movement. Switching moves the detector call from the left-turn phase (phase 7, protected lefts) to the adjacent through movement phase (phase 4, throughs & permissive lefts) during the through movement green time to accommodate more left turners. If switching were not used (as in this example), absent of a vehicle detection for phase 4 or 8 (side street throughs), then the side street protected left-turn phase would max out, cross the barrier, and return to the next phase to be served on the main street (see Exhibit 5-6).

When selecting the type of detection for new signalized intersections or as a replacement for detection at existing signalized intersections, the following considerations may be made:

- Is detection of multiple user groups required (i.e., motorists, pedestrians, motorcycles, etc.)?
- Is the detection proprietary or is it compatible with various/existing interfaces?
- Is the detection reliable and does it have a good reputation?
- What is the expected life of the detection?
- Will the detection require changes in existing infrastructure?

- Does the detection have the capability to be located where its repair will not require interrupting traffic? Are alternatives available that won't require the interruption of traffic flow?
- Will repairs need to be accomplished by contract or in-house?
- How do environmental conditions affect the detection (e.g., wind, ice, glare, occlusion, shadowing, and fog may limit the capabilities of some video and above-roadway detection)? Is there potential for accelerated wear and tear of equipment due to weather (freeze, thaw, heat) or pavement movement or failure?
- Does the detection have other capabilities aside from traffic detection (i.e., volume and classification counts, occupancy, etc.)? Compared with other methods of data collection, is this method reliable?
- What is the fail-safe condition for detected fault? Does the system have a diagnostic or alert system due to fault?
- If in-roadway detection is used, in what type of surface will the detection be installed (i.e., concrete, old asphalt, gravel, etc.)? Will future pavement surface maintenance affect its operation, temporarily (work zone during construction) or permanently?
- Will the detection require boring or trenching?
- What are the initial and lifecycle costs? Does the detection have ongoing regular maintenance costs?
- Do the detector equipment specifications match the stated operational and safety needs?

5.5.2 Pedestrian Detection

Pedestrian detection at actuated signals is typically accomplished through the use of pedestrian push buttons. Accessible pedestrian signal detectors, or devices to help pedestrians with visual or mobility impairments activate the pedestrian phase, may be pushbuttons or other passive detection devices. For pushbuttons to be accessible, they should be placed in accordance with the guidance in the MUTCD (Sections 4E.08, 4E.09).⁽¹⁾

- Unobstructed and adjacent to a level all-weather surface to provide access by a wheelchair with a wheelchair-accessible route to the ramp.
- Within 5 ft of the crosswalk extended.
- If possible, between 1.5 and 6 ft from edge of curb. If physical constraints make this impractical, locate no more than 10 ft off the edge of the curb, shoulder, or pavement.
- Parallel to the crosswalk to be used.
- Separated from other pushbuttons by a distance of at least 10 ft.
- Mounted at a height of at least 3.5 ft and no more than 4.0 ft above the sidewalk.

Types of passive detection devices include, but are not limited to, video and infrared camera systems. Pedestrian detection can be helpful for assigning right-of-way when installed at locations with high demands of both pedestrian and vehicle volumes. As one form of transportation demand increases over another, the detection can instruct the signal controller to give precedence to the higher demand. Pedestrian detection may also allow for detection of users that will require extended walk times. Alternative methods of pedestrian detection, including infrared and microwave detectors, are emerging. Additional information on these devices can be found in FHWA's *Pedestrian Facilities User Guide—Providing Safety and Mobility*.⁽³⁸⁾

5.6 TRAFFIC SIGNAL CONTROL TYPE

Traffic signals operate in pre-timed, semi-actuated, or actuated mode based on the presence and operations of detectors. Pre-timed signals operate with fixed cycle lengths and green splits, and in turn can operate either in isolation or coordination with adjacent traffic signals. Pre-timed coordinated signals can feature multiple timing plans with different cycle, split, and offset values for different periods of the day. Pre-timed control is ideally suited to closely spaced intersections where traffic volumes and patterns are relatively consistent on a daily or day-of-week basis.⁽⁶⁶⁾

Actuated signals vary the amount of green time allocated to each phase based on traffic demand; these signals can operate either in a fully actuated or semi-actuated mode. Actuated control provides variable lengths of green timing for phases that are equipped with detectors. The time for each movement depends on the characteristics of the intersection and timing parameters which are based on demand at the intersection.

An intersection that is fully actuated does not have a fixed cycle length; the durations of all phases are dependent on either vehicle actuations on their approaches or on maximum green times. An intersection that is under semi-actuated control typically has detectors on the minor street and on the major street left turns, but not on the major street through movements. The signal controller dwells or rests in the major street through phases and services the minor movements (i.e., minor streets and major street left-turns) upon demand. The intersection does not have a fixed cycle length.

An actuated signal can also work in coordination with other nearby traffic signals. A coordinated signal with actuated phases (actuated-coordinated) operates similarly to an intersection under semi-actuated control. The major street through phases are usually not actuated, the minor movements (including major street left turns) are actuated, and the intersection operates with a fixed cycle length. By fixing the major street movements, the coordination creates a “green band” for traffic to move smoothly through multiple adjacent intersections. This green band can be increased if unused green time is available from the other movements; it can be given to the major street through movement to further improve coordination. This unused time can also be shared with other movements as desired by the practitioner.

Some agencies have implemented more advanced traffic control plans using additional detection or adaptive control plans. Traffic responsive systems typically include additional “system detectors” between signals to provide more information to the system. Volume thresholds for a set of sensors are pre-determined by the traffic engineer to invoke specific cycles, splits, and offset combinations. This information can be used to help the controller choose the most appropriate plans for the current situations. Adaptive control has been used to improve traffic congestion and reduce delay using conventional signal control systems. Adaptive signal control technology continuously adjusts the signal timing (including modifying cycle lengths) beyond what is done by fully actuated or actuated-coordinated control by responding to changing traffic patterns. Adaptive control can distribute green times equitably to all traffic movements, improve travel time reliability and prolong the effectiveness of a traffic signal timing plan.

5.7 BASIC SIGNAL TIMING PARAMETERS

Signal operation and timing have a significant impact on intersection performance. Controllers have a vast array of inputs that permit tailoring of controller operation to the specific intersection. This section provides guidance for determining basic timing parameters.

The development of a signal timing plan should address all user needs at a particular location, including pedestrians, bicyclists, transit vehicles, emergency vehicles, automobiles, and trucks. For the purposes of this section, signal timing is divided into two elements: pedestrian timing and vehicle timing.

5.7.1 Vehicle Timing—Green Interval

Ideally, the length of the green display should be sufficient to serve the demand present at the start of the green phase for each movement and should be able to move groups of vehicles, or platoons, in a coordinated system. At an actuated intersection, the length of the green interval varies based on inputs received from the detectors. Minimum and maximum green times for each phase are assigned to a controller to provide a range of allowable green times. Detectors are used to measure the amount of traffic and determine the required time for each movement within the allowable range.

In pre-timed operations, minimum green and maximum green are equal. The green interval should meet the driver expectancy requirements, pedestrian requirements, and the requirements to clear the expected queue at the stop line. When the detector is at the stop line, the minimum green time should meet driver expectancy requirements and pedestrian requirements.⁽¹⁾ The minimum green is generally set to approximately 5 to 15 seconds based on the type of street and the type of movement to meet driver expectancy.

When the detector is located upstream of the stop line, the minimum green must meet the additional requirement to clear the vehicles queued between the stop line and the detector nearest the stop line. Consider an intersection with the following properties: average vehicle spacing is 25 ft per vehicle, initial start-up time is 2 s, and vehicle headway is 2 s per vehicle. For an approach with a detector located 100 ft from the stop line, the minimum green time is $2 + (100 \text{ ft} / 25 \text{ ft} \times 2) = 10 \text{ s}$.

The maximum green time is the maximum limit to which the green time can be extended for a phase in the presence of a call from a conflicting phase. Exhibit 5-17 illustrates the functionality of maximum green timer. The maximum green timer begins when a call is placed on a conflicting phase. The phase is said to "max-out" if the maximum green time is reached even if actuations have been received that would typically extend the phase.

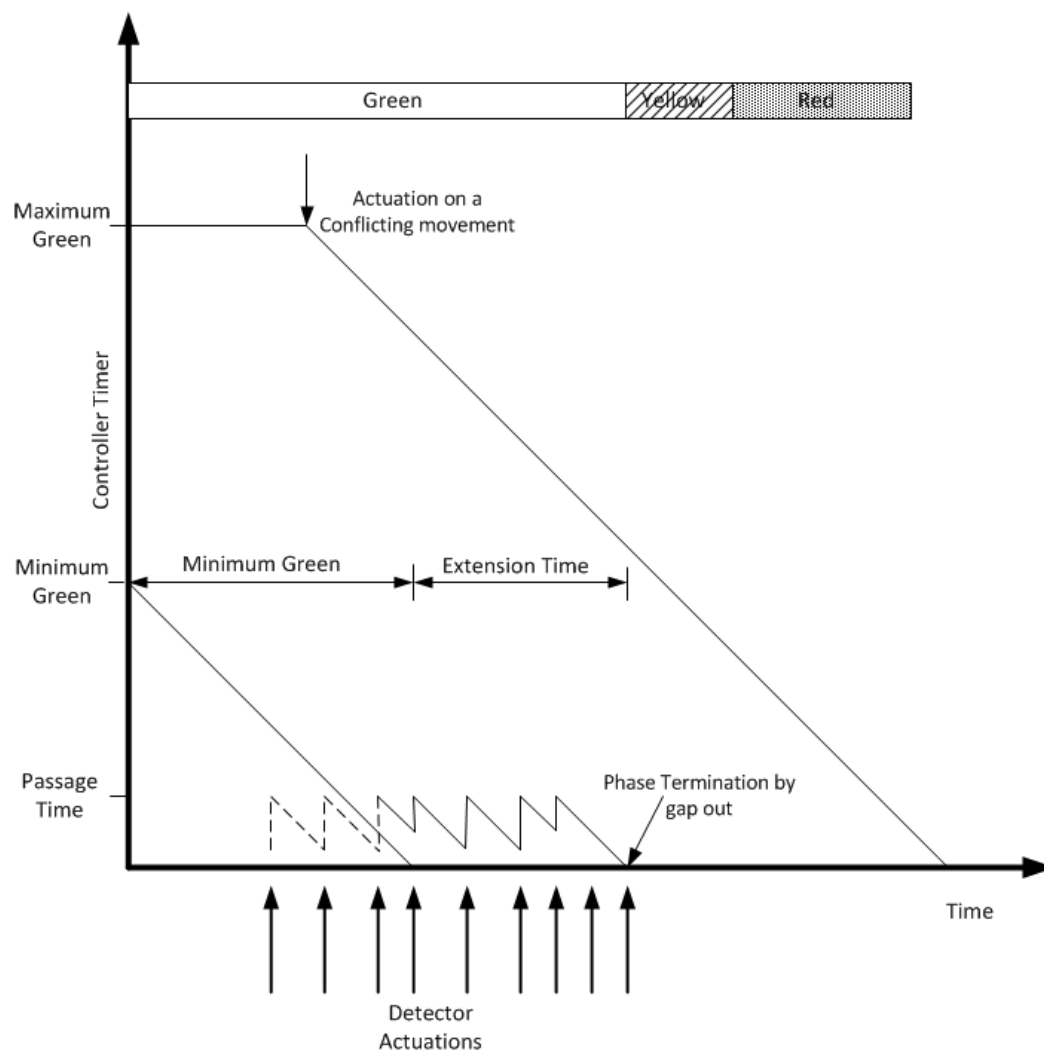

Exhibit 5-17. Illustration of maximum green functionality.

5.7.2 Vehicle Timing—Detector Inputs

One advantage of actuated control is its capacity to adjust timing parameters based on vehicle or pedestrian demand. The detectors and the timing parameters allow the signal to respond to varied flow throughout the day. For pedestrians, detectors are located for convenient access; for vehicles, detector spacing is a function of travel speed and the characteristics of the street. The operation of the signal is highly dependent on detector inputs. More information about detector features and settings for various detector configurations can be found in the FHWA *Traffic Detector Handbook*.⁽⁶³⁾

Volume-density timing is used to improve the efficiency of intersection operation. A gap-reduction feature called *variable initial* is used to improve intersection efficiency on approaches where the detectors are not at the stop line (presence detection) but a distance upstream of the stop line (advance or pulse detection). Variable initial, as illustrated in Exhibit 5-18, alleviates the need to provide a large minimum green to clear all vehicles stored between the stop line and the detector and thus improves intersection efficiency during low volume conditions. Another volume density feature called gap reduction uses gap timers to reduce the allowable gap time the longer the signal is green. This type of timing makes the signal less likely to extend the green phase the longer the signal is green. A typical setting for a volume-density controller is to have the passage

gap set to twice the calculated gap time to ensure the phase does not gap out too early. The minimum gap time might be set to less than the calculated gap time on multiple lane approaches, depending on the characteristics of the intersection.

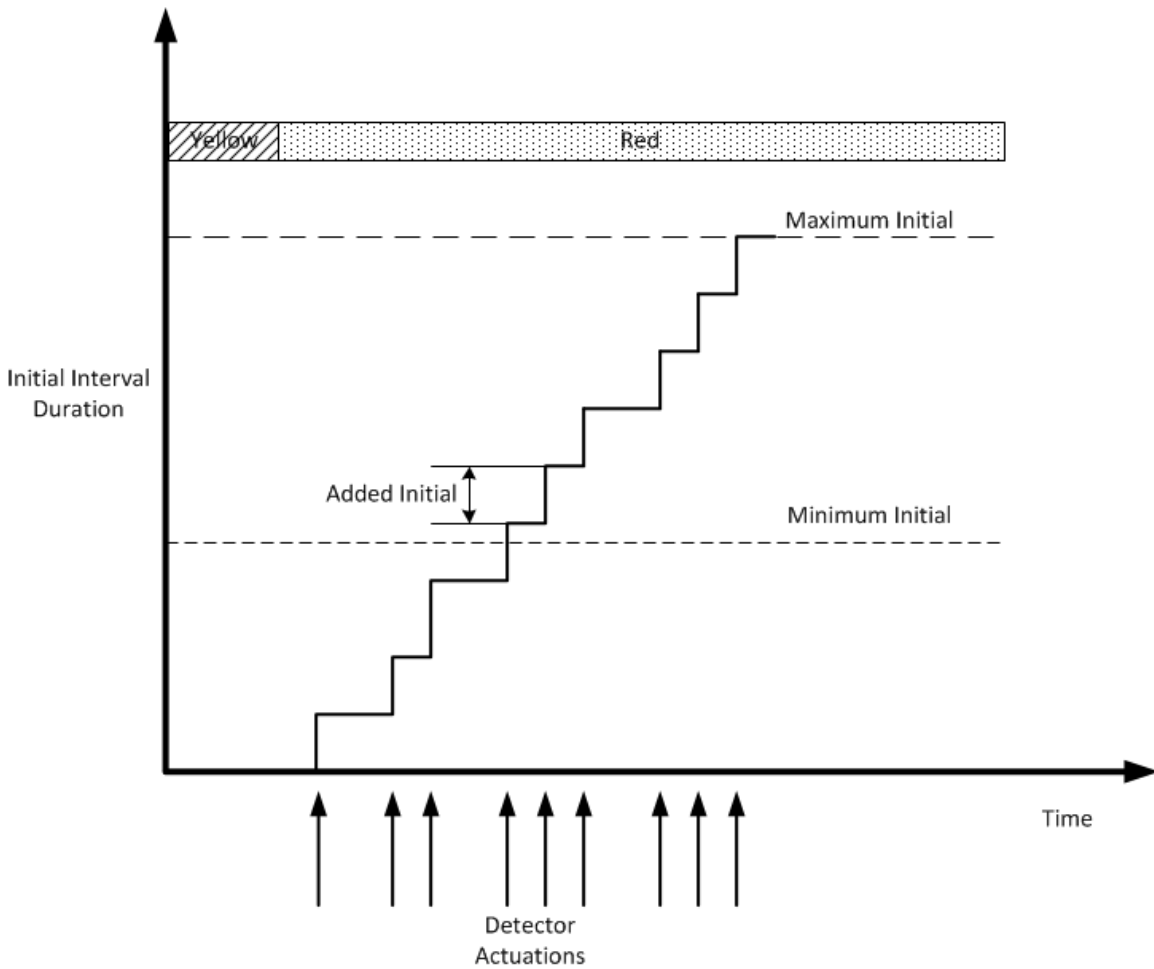

Exhibit 5-18. Illustration of variable initial feature.

Signal timing parameters may provide an opportunity to maximize the efficiency of the intersection. Signal timing parameters control how quickly the phase ends once traffic demand is no longer present. When coordination timings are used, the unused green time can be assigned to the coordinated phase or divided amongst the other phases, but should not exceed the split time.

5.7.3 Vehicle Timing—Vehicle Clearance

The vehicle clearance interval consists of the yellow change and red clearance intervals. The recommended practice for computing the vehicle clearance interval is the ITE formula (reference 56, equation 11-4), given in equation 2 (to use with metric inputs, use 1 m = 0.3048 ft):

$$CP = t + \frac{V}{2a + 64.4g} + \frac{W + L}{V} \quad (\text{U.S. Customary})$$

where: CP = change period (s)
 t = perception-reaction time of the motorist (s); typically 1
 V = speed of the approaching vehicle (ft/s)
 a = comfortable deceleration rate of the vehicle (ft/s²); typically 10 ft/s²
 W = width of the intersection, curb to curb (ft)
 L = length of vehicle (ft); typically 20 ft
 g = grade of the intersection approach (%); positive for upgrade, negative for downgrade

For change periods longer than 5 seconds, a red clearance interval is typically used. Some agencies use the value of the third term as a red clearance interval. The MUTCD does not require specific yellow or red intervals, but provides guidance that the yellow change interval should be approximately 3 to 6 seconds and that in most cases the red clearance interval should not exceed 6 seconds (Section 4D.26).⁽¹⁾ Note that because high-volume signalized intersections tend to be large and frequently on higher speed facilities, their clearance intervals are typically on the high end of the range. These longer clearance intervals increase loss time at the intersection and thus reduce capacity.

The topic of yellow and red clearance intervals has been much debated in the traffic engineering profession. At some locations, the yellow clearance interval is either too short or set improperly due to changes in posted speed limits or 85th percentile speeds. This is a common problem and frequently causes drivers to brake hard or to run through the intersection during the red phase. Because not all States follow the same law with regard to what is defined as "being in the intersection on the red phase," local practice for defining the yellow interval varies considerably.

Longer clearance intervals may cause drivers to enter the intersection later, breeding disrespect for the traffic signal. Wortman and Fox conducted a study that showed that the time of entry of vehicles into the intersection increased due to a longer yellow interval.⁽⁶⁷⁾ NCHRP 705 showed mixed results for the extension of the yellow change interval and the yellow/red change interval. It showed positive results on all crash types when the red change interval was extended.

5.7.4 Pedestrian Timing

Pedestrian timing requirements include a WALK interval and a pedestrian change (flashing upraised hand) interval. The WALK interval varies based upon local agency policy. The MUTCD recommends a minimum WALK time of 7 seconds, although WALK times as low as 4 seconds may be used if pedestrian volumes and characteristics do not require a 7-second interval (section 4E.06).⁽¹⁾ The WALK interval gives pedestrians adequate time to perceive the WALK indication and depart the curb before the pedestrian change (flashing upraised hand) interval begins.

In downtown areas, longer WALK times are often appropriate to promote walking and serve pedestrian demand. School zones and areas with large numbers of elderly pedestrians also warrant consideration and the display of WALK times in excess of the minimum WALK time.

The MUTCD states that the pedestrian clearance time should allow a pedestrian crossing in the crosswalk to leave the curb and travel to at least the far side of the traveled way or to a median of sufficient width for pedestrians to wait. The MUTCD uses a walk speed of 3.5 ft/s for determining crossing times.^(Error! Bookmark not defined.) However, FHWA pedestrian design guidance

recommends a lower speed if needed to accommodate users who require additional time to cross the roadway, and in particular a lower speed in areas where there are concentrations of children and or elderly persons. Pedestrian clearance time is calculated using equation 1:

$$\text{Pedestrian Clearance Time} = \frac{\text{Crossing Distance}}{\text{Walking Speed}}$$

where: Pedestrian Clearance Time is in seconds
 Crossing Distance is measured from the near curb to at least the far side of the traveled way or to a median; and
 Walking Speed is 3.5 ft/s as indicated above.

Pedestrian clearance time is accommodated during either a combination of pedestrian change (upraised hand) interval time and yellow change and red clearance time or by pedestrian change (upraised hand) interval time alone. At high-volume locations, it may be necessary as a tradeoff for vehicular capacity to use the yellow change interval as part of satisfying the calculated pedestrian clearance time. According to the 2009 MUTCD,⁽¹⁾ a buffer interval illustrating a steady UPRaised HAND symbolizing DON'T WALK shall be displayed following the pedestrian change interval for at least 3 seconds prior to the release of any conflicting vehicular movement. The pedestrian intervals are illustrated in Exhibit 5-19.

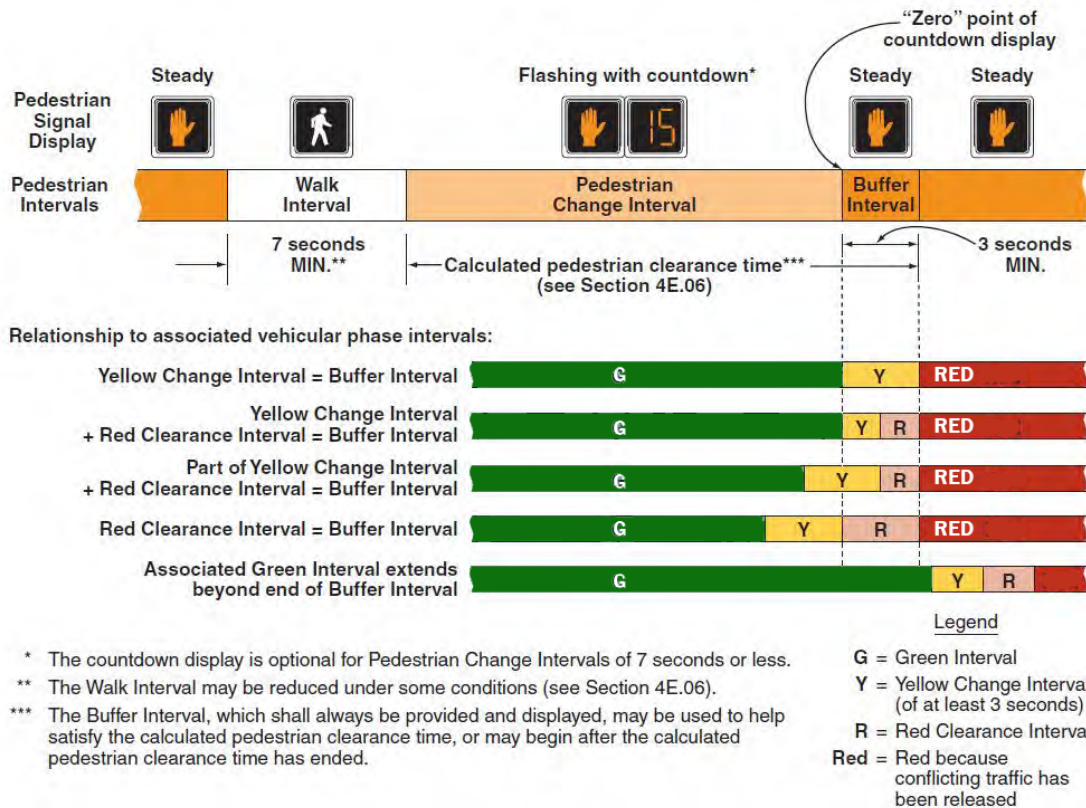

Exhibit 5-19. Pedestrian intervals.
 Source: 2009 MUTCD

Practitioners should also consider the impact of longer pedestrian intervals on vehicular green time and overall cycle lengths. Consideration should be given to the volume of pedestrians, the pedestrian walk speed used to calculate the pedestrian interval, and the volume and turn movements of vehicular traffic.

5.7.5 Vehicle Timing—Cycle Length

For isolated, actuated intersections, cycle length varies from cycle to cycle based on traffic demand and signal timing parameters. For coordinated intersections, a background cycle length is used to achieve consistent operation between consecutive intersections. In general, shorter cycle lengths are preferable to longer ones because they result in less delay and shorter queues. However, the need to accommodate multiple pedestrian movements across wide roadways, coupled with complex signal phasing and minimum green requirements to accommodate signal progression in multiple directions, may sometimes require the use of even longer cycle lengths. Wherever possible, such use should be limited to peak traffic periods only.

In general, cycle lengths for conventional, four-legged intersections should not exceed 120 seconds, although larger intersections may require longer cycle lengths of 140 to 150 seconds. Some busy intersections even operate at 180-second cycle lengths. Longer cycle lengths generally result in increased delay and queues to all users, particularly minor movements.

5.8 SIGNING AND PAVEMENT MARKING DESIGN

Signs and pavement markings are important elements of signalized intersection design. Because of the complexity of driver decisions, particularly at large signalized intersections, special attention to signing and pavement markings can maximize the safety and efficiency of the intersection. At signalized intersections, these traffic control devices serve several key functions, including:

- Advance notice of the intersection.
- Directional route guidance.
- Lane use control, including indications of permissive or prohibited turning movements.
- Regulatory control of channelized right turn movements (e.g., through the use of YIELD signs).
- Delineation and warning of pedestrian crossing locations.
- Delineation and warning of bicycle lane locations.

The MUTCD is the primary reference for use in the design and placement of signs and pavement markings.⁽¹⁾ Additional resources include State supplements to the MUTCD and reference materials such as ITE's *Traffic Control Devices Handbook* (TCDH)⁽⁶⁸⁾ and *Traffic Signing Handbook*.⁽⁶⁹⁾

Designing effective signing and pavement markings, particularly at high-volume signalized intersections, often requires thinking beyond standard drawings of typical sign and pavement marking layouts at intersections. High-volume signalized intersections typically have more lanes than most intersections. They may have redirected or restricted turning movements. They often join two or more designated routes (e.g., State highways) that require directional guidance to the user. They also are frequently located in urban areas where other intersections, driveways, and urban land use create visibility conflicts. The following questions, adapted from the ITE *Traffic Signing Handbook*,⁽⁶⁹⁾ represent a basic thought process recommended for engineers to follow when developing a sign layout at an intersection:

1. **From a given lateral and longitudinal position on the roadway, what information does the user need, both in advance and at the intersection?** At signalized intersections, is information on lane use provided at the intersection? Is advance street name information ("XX Street, Next Signal," etc.) and (if appropriate) route number directional signing provided in advance of the intersection? Exhibit 5-20 gives an example of an advance sign that provides street names for the next two signalized intersections.



Exhibit 5-20. Example of advance street name sign for two closely spaced intersections.

2. **Are there any on- or off-road conditions that would violate driver expectancy?** Lane drops and right-hand exits for left turns are both examples where driver expectancy is violated and should be addressed with signing. Exhibit 5-21 shows an example of signing used to advise motorists of a dropped lane at an upcoming intersection.



Exhibit 5-21. Example of signing for a left-hand lane drop.

3. **Is a specific action required by a road user?** If the road user needs to be in an appropriate lane in advance of an intersection to make a movement at the intersection, signing and corresponding pavement markings should convey this message to the user. Exhibit 5-22

provides an example of overhead signs and pavement markings used to assist drivers in selecting the proper lane on the approach to a signalized intersection.



Exhibit 5-22. Example of advance overhead signs and pavement markings indicating lane use for various destinations.

4. **Are signs located so that the road user will be able to see, comprehend, and attend to the intended message?** Signs must be simple enough to easily comprehend and attend to before the driver receives the next message. This requires adequate sign size, sign spacing, and attention to the number of elements on each sign. Additional signing enhancements, consistent with the principles of sign and message spreading (separating overlapping or numerous route signs onto two installations to improve comprehension and readability), may include the use of overhead signs in advance of large intersections and/or large retro-reflectORIZED or internally illuminated overhead signs (including street name signs) at the intersections.
5. **For what part of the driver population is the sign being designed?** Have the needs of older drivers or nonlocal drivers been accommodated? This may require the use of larger lettering or sign illumination.
6. **Does the sign “fit in” as part of the overall sign system?** Signing at an intersection needs to be consistent with the overall sign layout of the connecting road system. For example, the consistent use of guide signs is helpful to freeway users in identifying the appropriate exit. Similar consistency is needed on arterial streets with signalized intersections.

Pavement markings also convey important guidance, warnings, and regulatory lane-use information to users at signalized intersections. In addition to delineating lanes and lane use, pavement markings clearly identify pedestrian crossing areas, bike lanes, and other areas where driver attention is especially important. Where in-pavement detection is installed for bicycles and motorcycles, appropriate markings should be painted to guide these vehicles over the portion of the loop that will best detect them.

Several supplemental pavement markings are particularly useful at large signalized intersections. For example, the use of lane line extensions (dotted white lines) into the intersection can be a helpful tool where the intersection is so large that the alignment of through

or turning lanes between entering the intersection and exiting the intersection could be confused. This can occur, for example, where multiple turn lanes are provided, where the through lane alignments make a curve through the intersection, or where the receiving lanes at an intersection are offset laterally from the approach lanes. In addition, pavement legends indicating route numbers and/or destinations in advance of the intersection (i.e., “horizontal signage”) may be used to supplement signing for this purpose, as shown in Exhibit 5-23.



Exhibit 5-23. Example of pavement legends indicating destination route numbers (“horizontal signage”).

5.9 ILLUMINATION DESIGN

As noted in the *American National Standard Practice for Roadway Lighting (RP-8-00)*, “[t]he principal purpose of roadway lighting is to produce quick, accurate, and comfortable visibility at night. These qualities of visibility may safeguard, facilitate, and encourage vehicular and pedestrian traffic... [T]he proper use of roadway lighting as an operative tool provides economic and social benefits to the public including:

- (a) Reduction in night accidents, attendant human misery, and economic loss.
- (b) Aid to police protection and enhanced sense of personal security.
- (c) Facilitation of traffic flow.
- (d) Promotion of business and the use of public facilities during the night hours.⁽⁷⁰⁾

Specifically with respect to intersections, the document notes that “[s]everal studies have identified that the primary benefits produced by lighting of intersections along major streets is the reduction in night pedestrian, bicycle and fixed object accidents” (Section 3.6.2).⁽⁷⁰⁾ With respect to signalized intersections, roadway lighting can play an important role in enabling the intersection to operate at its best efficiency and safety. The highest traffic flows of the day (typically the evening peak period) may occur during dusk or night conditions where lighting is critically important, particularly in winter for North American cities in northern latitudes.

The document includes three different criteria for roadway lighting: illuminance, luminance, and small target visibility (STV). These are described as follows:

- Illuminance is the amount of light incident on the pavement surface from the lighting source.

- Luminance is the amount of light reflected from the pavement toward the driver's eyes. The luminance criterion requires more extensive evaluation. Because the reflectivity of the pavement surfaces constantly changes over time, it is difficult to accurately estimate this criterion.
- Small target visibility is the level of visibility of an array of targets on the roadway. The STV value is determined by the average of three components: the luminance of the targets and background, the adaptation level of adjacent surroundings, and the disability glare.

5.9.1 Illuminance

The two principal measures used in the illuminance method are light level and uniformity ratio. Light level represents the intensity of light output on the pavement surface and is reported in units of lux (metric) or footcandles (U.S. Customary). Uniformity represents the ratio of either the average-to-minimum light level (E_{avg}/E_{min}) or the maximum-to-minimum light level (E_{max}/E_{min}) on the pavement surface. The light level and uniformity requirements are dependent on the roadway classification and the level of pedestrian night activity.

The basic principle behind intersection lighting is that the amount of light on the intersection should be proportional to the classification of the intersecting streets and equal to the sum of the values used for each separate street. For example, if Street A is illuminated at a level of x and Street B is illuminated at a level of y , the intersection of the two streets should be illuminated at a level of $x+y$. RP-8-00 also specifies that if an intersecting roadway is illuminated above the recommended value, then the intersection illuminance value should be proportionately increased. If the intersection streets are not continuously lighted, a partial lighting system can be used. RP-8-00 and its annexes should be reviewed for more specific guidance on partial lighting, the specific calculation methods for determining illuminance, and guidance on the luminance and STV methods.⁽⁷⁰⁾

Exhibit 5-24 presents the recommended illuminance for the intersections within the scope of this document located on continuously illuminated streets. Separate values have been provided for portland cement concrete road surfaces (RP-8-00 Road Surface Classification R1) and typical asphalt concrete road surfaces (RP-8-00 Road Surface Classification R2/R3).

Exhibit 5-25 presents the roadway and pedestrian area classifications used for determining the appropriate illuminance levels in exhibit 5-26. RP-8-00 clarifies that although the definitions given in exhibit 5-25 may be used and defined differently by other documents, zoning bylaws, and agencies, the area or roadway used for illumination calculations should best fit the descriptions contained in exhibit 5-25 (section 2.0, p. 3).⁽⁷⁰⁾

5.9.2 Veiling Luminance

Stray light from light sources within the field of view produces veiled luminance. This stray light is superimposed in the eye on top of the retinal image of the object of interest, which alters the apparent brightness of that object and the background in which it is viewed. This glare, known as disability glare, reduces a person's visual performance and thus must be considered in the design of illumination on a roadway or intersection.⁽⁷⁰⁾ Exhibit 5-24 shows the maximum veiling luminance required for good intersection lighting design.

Exhibit 5-24. Recommended illuminance for the intersection of continuously lighted urban streets.

Pavement Classification ¹	Roadway Classification	Average Maintained Illuminance at Pavement			Uniformity Ratio (Eavg/Emin) ³	Veiling Luminance Ratio (Lvmax/Lavg) ⁴
		Pedestrian/Area Classification				
		High (lux (fc) ²)	Medium (lux (fc) ²)	Low (lux (fc) ²)		
R1	Major/Major	24.0 (2.4)	18.0 (1.8)	12.0 (1.2)	3.0	0.3
	Major/Collector	20.0 (2.0)	15.0 (1.5)	10.0 (1.0)	3.0	0.3
	Major/Local	18.0 (1.8)	14.0 (1.4)	9.0 (0.9)	3.0	0.3
	Collector/Collector	16.0 (1.6)	12.0 (1.2)	8.0 (0.8)	4.0	0.4
	Collector/Local	14.0 (1.4)	11.0 (1.1)	7.0 (0.7)	4.0	0.4
	Local/Local	12.0 (1.2)	10.0 (1.0)	6.0 (0.6)	6.0	0.4
R2/R3	Major/Major	34.0 (3.4)	26.0 (2.6)	18.0 (1.8)	3.0	0.3
	Major/Collector	29.0 (2.9)	22.0 (2.2)	15.0 (1.5)	3.0	0.3
	Major/Local	26.0 (2.6)	20.0 (2.0)	13.0 (1.3)	3.0	0.3
	Collector/Collector	24.0 (2.4)	18.0 (1.8)	12.0 (1.2)	4.0	0.4
	Collector/Local	21.0 (2.1)	16.0 (1.6)	10.0 (1.0)	4.0	0.4
	Local/Local	18.0 (1.8)	14.0 (1.4)	8.0 (0.8)	6.0	0.4

¹ R1 is typical for portland cement concrete surface; R2/R3 is typical for asphalt surface.

² fc = footcandles

³ Eavg/Emin = Average illuminance divided by minimum illuminance

⁴ Lvmax/Lavg = Maximum veiling luminance divided by average luminance.

Source: Reference 70, table 9 (for R2/R3 values); R1 values adapted from table 2.

Exhibit 5-25. RP-8-00 guidance for roadway and pedestrian/area classification for purposes of determining intersection illumination levels.

Roadway Classification	Description	Average Daily Vehicular Traffic Volumes (ADT)¹
Major	That part of the roadway system that serves as the principal network for through-traffic flow. The routes connect areas of principal traffic generation and important rural roadways leaving the city. Also often known as "arterials," thoroughfares," or "preferentials."	More than 3,500
Collector	Roadways servicing traffic between major and local streets. These are streets used mainly for traffic movements within residential, commercial, and industrial areas. They do not handle long, through trips.	1,500 to 3,500
Local	Local streets are used primarily for direct access to residential, commercial, industrial, or other abutting property.	100 to 1,500

Pedestrian Conflict Area Classification	Description	Possible Guidance on Pedestrian Traffic Volumes²
High	Areas with significant numbers of pedestrians expected to be on the sidewalks or crossing the streets during darkness. Examples are downtown retail areas, near theaters, concert halls, stadiums, and transit terminals.	More than 100 pedestrians/hour
Medium	Areas where lesser numbers of pedestrians use the streets at night. Typical are downtown office areas, blocks with libraries, apartments, neighborhood shopping, industrial, older city areas, and streets with transit lines.	11 to 100 pedestrians/hour
Low	Areas with very low volumes of night pedestrian usage. These can occur in any of the cited roadway classifications but may be typified by suburban single family streets, very low density residential developments, and rural or semirural areas.	10 or fewer pedestrians/hour

Notes: ¹ For purposes of intersection lighting levels only.

² Pedestrian volumes during the average annual first hour of darkness (typically 18:00-19:00), representing the total number of pedestrians walking on both sides of the street plus those crossing the street at non-intersection locations in a typical block or 656 ft section. RP-8-00 clearly specifies that the pedestrian volume thresholds presented here are a local option and should not be construed as a fixed warrant.

Source: Reference 70, sections 2.1, 2.2, and 3.6

Part II

Analysis Methods

Part II includes a description of safety analysis methods (chapter 6) and operational analysis methods (chapter 7) that can be used in the evaluation of a signalized intersection. The chapters in part II provide the reader with the tools needed to determine deficiencies of a signalized intersection and areas for improvement and mitigation. The findings from part II should be used to identify applicable treatments in part III.

CHAPTER 6

SAFETY ANALYSIS METHODS

TABLE OF CONTENTS

6.0	SAFETY ANALYSIS METHODS	6-3
6.1	Qualitative Approach.....	6-4
6.2	Quantitative Approach	6-6
6.3	Network Screening or Selection of an Intersection.....	6-6
6.3.1	Average Crash Frequency	6-7
6.3.2	Crash Rate	6-8
6.3.3	Critical Rate.....	6-8
6.3.4	Equivalent Property Damage Only (EPDO) Average Crash Frequency.....	6-9
6.3.5	Relative Severity Index	6-9
6.3.6	Excess Predicted Average Crash Frequency Using Safety Performance Functions	6-10
6.3.7	Excess Expected Average Crash Frequency with Empirical Bayes Adjustment.....	6-10
6.3.8	Summary.....	6-11
6.3.9	Case Study.....	6-12
6.4	Diagnosis	6-14
6.4.1	Step 1 – Conduct Safety Data Review	6-14
6.4.2	Step 2 – Assess Supporting Documentation	6-16
6.4.3	Step 3 – Assess Field Conditions	6-17
6.4.4	Define Problem Statement(s).....	6-28
6.4.5	Case Study.....	6-20
6.5	Selecting Countermeasures.....	6-27
6.5.1	Case Study.....	6-30
6.6	Economic Appraisal	6-32
6.6.1	Step 1 – Estimate Benefits of Countermeasures	6-32
6.6.2	Step 2 – Estimate Costs of Countermeasures.....	6-34
6.6.3	Step 3 – Evaluate Cost Effectiveness of Countermeasures	6-34
6.6.4	Case Study.....	6-34
6.7	Project Prioritization	6-35
6.7.1	Case Study.....	6-36
6.8	Safety Effectiveness Evaluation.....	6-37
6.8.1	Before-After Study with Comparison Group	6-37
6.8.2	Before-After Study with Empirical Bayes	6-37

LIST OF EXHIBITS

6-1	Road safety management process	6-4
6-2	Societal crash costs and EPDO weights	6-9
6-3	Common methods of assessing safety at a location	6-11
6-4	Top 10 ranked signalized intersections in a county.....	6-13
6-5	Example Problem Statements	6-19
6-6	Possible taxonomy for crash type classification	6-20
6-7	Study intersection	6-21
6-8	Lane configuration of the study intersection	6-22
6-9	Crashes in the study intersection from 2006 to 2010, by severity.....	6-22
6-10	Crashes at the study intersection from 2006 to 2010, by impact type.....	6-23

6-11	Crash frequencies in terms of crash impact types and road surface conditions	6-23
6-12	Crash frequencies in terms of crash impact types and light conditions.....	6-24
6-13	Crash diagram for the intersection of Street A and Road B	6-25
6-14	Field investigation findings.....	6-26
6-15	Problem statements.....	6-27
6-16	Crash types commonly identified, possible causes, and associated treatments	6-29
6-17	Proposed long list of countermeasures	6-30
6-18	Societal crash cost estimates by crash severity	6-33
6-19	Example calculation of safety benefit of adding a right-turn lane	6-34
6-20	Summary of benefit-cost analysis.....	6-35
6-21	Priority ranking of selected countermeasures	6-36

6.0 SAFETY ANALYSIS METHODS

In addition to operational needs, it is important for signalized intersections to operate safely. Intersections constitute of a small portion of the National Highway System. However, intersection related crashes constitute more than 20 percent of fatal crashes.⁽⁷¹⁾ In some cases a signal is even installed for safety reasons (e.g., severe angle crashes at a stop-controlled intersection). As a result, the safety performance of signalized intersections is as important as the operational performance of these intersections. Signalized intersections must be systematically and continuously monitored throughout their life.

Historically, safety practitioners have identified intersections with the highest number of crashes in a specified time period and focused their efforts and resources at those intersections. This reactive approach can be effective in addressing a small number of high-crash locations.

During the past two decades, road agencies have started to recognize the challenges associated with a highly reactive approach to road safety.⁽⁷¹⁾

The paradigm shift from a reactive approach to road safety (i.e., only investigate locations with high crash frequency) to also incorporating a proactive approach (i.e., incorporate road safety in all stages of a roadway cycle) occurred in conjunction with the development of analytical tools by researchers and practitioners. These tools can be categorized into qualitative and quantitative tools.

Qualitative approaches are often used when enough historical data is not available or when an intersection is in the planning or design stage. A Road Safety Audit (RSA) is one of the qualitative approaches. The RSA is a formal safety performance examination of an existing or future road or intersection by an independent audit team.

Quantitative approaches have been mostly collected in the Highway Safety Manual (HSM), published by AASHTO in 2010.⁽¹¹⁾ The HSM presents a systematic approach for a road safety management process. The road safety management process shown in Exhibit 6-1 can be applied to one road entity (e.g., an intersection) or a network (e.g., all signalized intersections in a jurisdiction). This road safety management process starts with network screening in which the main goal is identification of road locations likely to benefit the most from safety improvements. The underlying assumption is that road design attributes often play a significant contributory role in crash occurrence. In network screening, the safety performance of each individual location is compared with the safety performance of similar locations in a jurisdiction to identify whether the safety performance of the subject location is acceptable.

The next step in the road safety management process is diagnosis. This step examines the contributing factors of crashes for locations identified in the network screening process to determine the cause and prepare for the identification of treatments in the next steps.

Countermeasure selection and economic appraisal constitute the next steps in the road safety management process. This involves the selection of treatments potentially able to address the safety issues identified in the diagnosis step. In the course of this selection process, more than one countermeasure with the potential to mitigate the problem is often identified. A subsequent economic appraisal will evaluate all options for all problem locations in order to ensure that the countermeasures are economically viable. In the prioritization of countermeasure projects, the objective is to maximize benefits in terms of crash reductions subject to budget restrictions. Safety effectiveness evaluation involves monitoring implemented improvements to assess their safety effectiveness. The information obtained in this step is extremely valuable for prospective studies so that practitioners can make informed decisions about the effectiveness of each countermeasure.

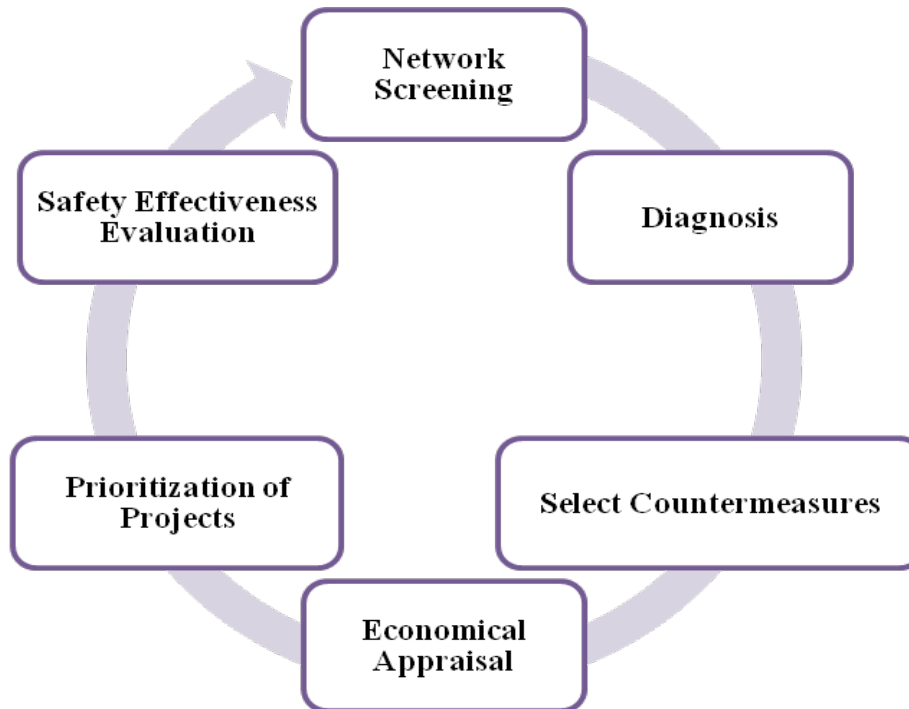

Exhibit 6-1. Road safety management process.⁽⁷²⁾

The road safety management process is a continuous process demanding significant resources from road authorities, particularly jurisdictions which constitute large geographic areas (e.g., State agencies). The process requires an extensive amount of data, which should be collected annually. Consequently, road authorities automated the road safety management process as much as possible to increase the efficiency of their road safety programs. In response to this increasing need of road authorities, AASHTO released *SafetyAnalyst* in 2009. *SafetyAnalyst* is a software package that consists of four modules containing six analytical tools, and these analytical tools correspond to the six steps of the road safety management process outlined above.

6.1 QUALITATIVE APPROACH

Qualitative approaches to road safety are important tools that can help a traffic engineer to have a better understanding of the safety issues at signalized intersections. These techniques are especially helpful in circumstances in which the intersection is in the planning or design stage and sufficient operational data (to quantitatively identify the safety problems) or historical data (e.g., collision, volume, etc.) data about the subject intersection is not available. Different qualitative techniques are used by traffic engineers including:

- Positive guidance review.
- Driver behavior observation.
- Human factors review.
- Conflict analysis.
- Surrogate measures such as time to collision using traffic simulation models (e.g., Surrogate Safety Analysis Model (SSAM)).

The above techniques can be used independently or as part of a formal RSA process.

An RSA can be used in any phase of project development, from planning and preliminary engineering to design and construction, regardless of the size of the project. RSAs applied early in the planning and preliminary (functional) design of roads offer the greatest opportunity for benefit. As design progresses into detailed design and construction, changes that may improve safety performance typically become more difficult, costly, and time consuming to implement.

An RSA audit team consists of a multidisciplinary group of experts who review the intersection from different perspectives, such as safety, design, traffic operations, law enforcement, maintenance, etc. The level of success that can be achieved in using the RSA process is highly dependent on the knowledge, skills, experience, and attitudes of the auditors. The team should be able to review project data critically, get the most from the field visits, and engage in the kind of dialogue that leads to the identification of road safety issues. It is important to ensure that a local contact person is included in the audit team.

RSA process includes the following steps:

- **Step 1:** Identify intersection to be audited.
- **Step 2:** Select RSA team.
- **Step 3:** Conduct a pre-audit meeting to review project information.
- **Step 4:** Perform field observations under various conditions.
- **Step 5:** Conduct audit analysis and prepare report of findings.
- **Step 6:** Present audit findings to project owner/design team.
- **Step 7:** Project owner/design team prepares formal response.
- **Step 8:** Incorporate findings into the project when appropriate.

When conducting the field investigation component of an RSA of an existing signalized intersection, the following elements are reviewed:

Conformance, Consistency, and Condition

- Relating to intersection and approach geometrics and geometric characteristics, traffic control devices (traffic signals, signing, pavement markings etc.), illumination and delineation devices, safety devices (guide rail systems, end treatments, crash cushions etc.), and all other roadway features present within the roadway environment on the day of the field investigation, including physical evidence of road user collisions.

Intersection and Approach Geometrics and Geometric Characteristics

- Layout and “readability” (perception) by drivers.
- Horizontal and vertical alignment (visibility all for road users - sight distance review as required).
- Cross-section, lane configuration, and lane continuity.
- Driveway/side street accessibility.
- Access management and corner clearance.
- Active transportation/vulnerable road user facilities (walkability, bicycling, and mobility restricted).
- Alternate mode facilities (e.g. transit).

Traffic Signals

- Visibility and conspicuity of signal displays on approach to and at the intersection (including a sufficient number of indications, recommended one per lane over each lane).

- Placement of signal heads (horizontal and vertical; within the drivers cone of vision).
- Operations (vehicular volumes, level of service, queue lengths, volume/capacity etc.).

Signing

- Advance intersection signing (warning, lane use).
- Advance and turn-off roadway identification signing (lane use, route guidance).
- Signing at the intersection (regulatory and guide).

Pavement Markings

- Proper lane line and edge line markings based on intended lane uses.
- Transverse markings as appropriate (stop lines, horizontal signing, and supplemental legends/symbols).

Illumination and Delineation Devices

- Roadway illumination and luminaire poles.
- Reflective guidance devices (guide posts, post mounted delineators, etc.).

Roadside Features

- Guide rail systems, end treatments, and crash cushions (within the roadway clear zone).
- Potential unprotected roadway and/or roadside hazards.

Site Operations and Road User Interactions

- Road user operations and interactions from the perspective of all users (pedestrians, bicyclists, motorcycles, trucks, buses, automobiles etc.).
- Human factors (positive guidance principles).
- Traffic speed and classification.
- Traffic patterns and behavior from the perspective of all road users.

FHWA published RSA Guidelines in 2006 to help safety professionals conduct a valid and successful RSA. The Guidelines include an intersection-specific prompt list that could prove valuable in reviewing a signalized intersection.⁽⁷²⁾

6.2 QUANTITATIVE APPROACH

The road safety management process systematically identifies deficient locations from safety perspectives and addresses safety problems at these locations. The following sections detail the road safety management process.

6.3 NETWORK SCREENING OR SELECTION OF AN INTERSECTION

In selecting an intersection for a detailed safety analysis, the key questions are:

- What is the safety performance of the location in comparison with other similar locations?
- Is the safety performance at the location acceptable or not acceptable?

Selection of an intersection may be the result of a systemic network screening of all signalized intersections in a jurisdiction or a complaint received by the traffic engineer in a jurisdiction. This section briefly describes most commonly used techniques for selecting one or more intersections that may have potential for safety improvements. This section also highlights the advantages and disadvantages of these techniques. It should be noted that the poor safety performance of an intersection (i.e., a sudden spike in frequency of crashes) during a few months

or a year should not warrant selection of the intersection for detailed review, because it is likely that crash frequency will decrease in the next few months. This term is referred to as “regression to the mean.”

The crash history of a signalized intersection is the key indicator of its safety performance and is the focus of the remainder of this section. The network screening techniques for evaluating crash performance vary from basic to the complex. They may compare the safety performance of a single signalized intersection to another group of similar intersections or serve as a screening tool for sifting through a large group of sites and determining which site has the most promise for improvement.

Many jurisdictions carrying out a review of safety at a signalized intersection will usually have a crash database that provides information on the location, time, severity, and other circumstances surrounding each crash reported by police or the parties involved. Crash data in this form can provide the traffic engineer with a quick assessment of safety at a location. The crash data is critical to the overall road safety management process. As a result, it is important for the traffic engineer to fully understand the crash data processing practices in a jurisdiction. For example, it is important to know what types of crashes are non-reportable. It is also critical to know the methodology for assigning crashes to intersections. In some jurisdictions, intersection-related crashes are assigned to the legs of intersections, and in other jurisdictions these crashes are directly assigned to the intersections.

Once data are available, the most common method of network screening is to compare the crash history of each site to other similar locations. For signalized intersections, similar intersections should have the same number of approaches as the site being examined; sites with different traffic control devices and layouts can be expected to have differing levels of safety. Surrounding land use will also have a significant effect on crash frequency, with intersections in urban areas having a different crash profile than intersections in rural areas. Finally, comparisons with sites that are located in other jurisdictions may be tainted by differing crash reporting thresholds, enforcement, predominant land use, vehicle mix, road users, climatic conditions, or other unknown factors; results of such a comparison should be tempered with caution.

With these in mind, different methods of using crash data to conduct network screening and assess safety performance of a site are discussed in the following sections, highlighting their benefits and drawbacks. The different methods to be discussed are:

- Average annual crash frequency.
- Crash rate.
- Critical rate.
- Equivalent property damage only (EPDO) average crash frequency.
- Excess predicted average crash frequency using safety performance functions (SPFs).
- Excess expected average crash frequency with empirical Bayes adjustment.

Chapter 4 of the HSM provides details of the above methods. Also, the HSM provides additional techniques for network screening. However, the techniques provided in this Guide are the most commonly used techniques in practice.

6.3.1 Average Crash Frequency

Traditionally, traffic engineers used (and many still use) a frequency-based method of identifying and evaluating the safety of a site.^{(71),(73)} Past average annual observed crash frequencies at a site over a certain time period may be used to compare and rank the site against crash frequencies at a reference group (i.e., a group of locations with similar characteristics). Many jurisdictions produce a top 10 list of the intersections producing the highest average crash frequency in their jurisdictions and concentrate all of their efforts at reducing crashes at these sites.

The average crash frequency method may also be used to screen candidate sites for improvements. The average crash frequency at the site may be compared to the average crash frequency for the reference population to calculate a potential for improvement.

The study period is often 3 to 5 years in safety analyses. Relatively short periods of time, such as one year of crash data, are not recommended as the basis for a safety intervention. Because crashes are relatively rare events, a high crash frequency in any given year at a particular intersection may be simply a random fluctuation around a much lower long-term average at the site. In the next year or series of years, the crash frequency may drop without any safety intervention at all. This phenomenon is referred to as regression to the mean. Regression to the mean may be minimized by using data collected over a longer period of time (3 to 5 years) when evaluating the site. Site selection based on multiple years of crash data will provide a truer picture of the crash profile of the intersection and avoid errors that can result from looking at crash history over a short period.

Apart from regression to the mean, there are several other disadvantages to using crash frequency as the sole means of evaluating safety at a site. First, a high crash frequency may not necessarily mean that a site is truly in need of safety improvement. It is known that sites with higher volumes will have a higher crash frequency than sites with lower volumes. Therefore, sites ranked simply by crash frequency will invariably end up with higher volume sites at the top of the list. Second, the method does not address the severity of crashes at the site. Failing to consider severity may result in the identification of sites with high numbers of minor crashes, while ignoring sites with fewer but more severe crashes. The approach results in a failure to identify sites at which the public has greater risk of injury or death.

6.3.2 Crash Rate

The crash rate method improves upon the average crash frequency in that it normalizes the frequency of crashes with the exposure, as measured by traffic. Crash rates are calculated by dividing the total crash frequency for a period of time by the estimated average annual daily traffic (AADT) of vehicles entering from all approaches in that time period. Crash rate provides an improved yardstick for comparison between sites. As with average crash frequency, a crash rate for an intersection undergoing a safety assessment may be compared to similar intersections (signalized, same number of legs, same range in AADT). The intersection may be ranked to produce a top 10 list, or a threshold value may be used above which a detailed safety analysis is warranted. Using a crash rate will account for the effect that volume has on crash frequency.

However, using a simple crash rate to screen locations has several disadvantages. First, using a crash rate to rank sites that have different volumes requires the assumption that crash frequency and volume have a linear relationship, but research suggests that this is not the case. Lower volume sites tend to experience a higher crash rate. Ignoring this fact means that low volume sites may appear less safe than their higher volume counterparts. Second, crash rates, as with crash frequency, do not consider crash severity. Sites with a high crash rate may have relatively few severe (fatal and injury) crashes. Last, as crash rates are calculated from crash frequency, which fluctuates around a long-term average and experiences regression to the mean, a site might be ranked high on a list due to a recent period with an unusually higher number of crashes. If crash rates are being used to screen out candidate sites for safety improvements, it is recommended that a study period between 3 to 5 years be selected.

6.3.3 Critical Rate

The critical crash rate method has been widely used among traffic engineers. In this method, the observed crash rate at a site is compared with a critical crash rate unique to each site. The critical crash rate for a site is a function of the average crash rate of a reference group associated with the site, the traffic volume of the site, and a desired level of confidence. In this method, sites where the crash rates exceed the critical rate require further detailed analysis in the diagnosis step, which is the next step of the road safety management process.

The critical crash rate method is more robust than using average crash frequency or crash rate alone, as it provides a means of statistically testing how different the crash rate is at a site when compared to a reference group. The desired level of confidence may vary depending on the preference of the user.

Disadvantages of using this method are that it still does not consider the severity of the crashes and assumes that traffic volume and crashes have a linear relationship. In addition, this approach does not consider regression to the mean.

6.3.4 Equivalent Property Damage Only (EPDO) Average Crash Frequency

In the above discussion, sites were considered for further analysis if the crash frequency and rate were particularly high. As indicated, a weakness with these methods is not considering the severity of the crashes involved. The crash severity method considers the distribution of crash severity for each site under consideration. A typical approach is through the use of the EPDO score. It attaches greater importance, or weight, to crashes resulting in a serious injury or a fatality, lesser importance to crashes resulting in a moderate or slight injury, and the least importance to property-damage-only crashes.

The HSM suggests using the ratio of the societal cost of crashes over the societal cost of PDO crashes as weighting factors to calculate an EPDO score for each site. Exhibit 6-2 shows the suggested societal crash costs and EPDO weight factors by the HSM.

Severity	Cost	Weight
Fatal (K)	\$4,008,900	542
Injury (A/B/C)	\$82,600	11
PDO (O)	\$7,400	1

Exhibit 6-2. Societal crash costs and EPDO weights.⁽⁷¹⁾

Depending on local considerations, the above weighting system may be modified to reflect actual values in terms of cost, such as property damage, lost earnings, lost household production, medical costs, and workplace costs. A comparison with similar intersections (signalized, same number of legs, same range of AADT) may be done by calculating the EPDO score for similar sites to the one being considered. The EPDO score will explicitly consider the severity breakdown of crashes, providing greater weight to fatal and injury crashes over PDO crashes. The traffic engineer should be aware, however, that because the severity of a crash is associated with higher speeds, signalized intersections on roads with a higher operating speed, such as in a rural location, will likely have a higher EPDO score than those in urban areas. This may result in a bias that emphasizes higher speed locations. In addition, as with rankings based on crash frequency and rate, regression to the mean will be an issue if the study period chosen is short.

6.3.5 Relative Severity Index

Monetary crash costs are assigned to each crash type and the total cost of all crashes is calculated for each site. An average crash cost per site is then compared to an overall average crash cost for the site's reference population. The overall average crash cost is an average of the total costs at all sites in the reference population. The resulting Relative Severity Index (RSI) performance measure shows whether a site experiences higher crash costs than the average for other sites with similar characteristics. Strengths of this method include the simplicity of the analysis and the consideration of collision type and crash severity. Weaknesses include lack of Regression-to-the-Mean bias or traffic volume considerations. This type of analysis can also overemphasize locations with a small number of severe crashes depending on weighting factors, and it can prioritize low-volume, low-collision sites.

6.3.6 Excess Predicted Average Crash Frequency Using Safety Performance Functions

In this technique for network screening, average crash frequency at a site is compared with a predicted average crash frequency, obtained from an SPF. If the observed average crash frequency exceeds the predicted average crash frequency at a site, the site is flagged for further analysis. The SPF equation presents the mathematical relationship between crash frequency and volume for a reference group (e.g., 4-leg signalized intersections in a jurisdiction). When crash frequency and volume are plotted, an equation can be developed that is represented by a curve that is the best fit possible through the various points. Generally, SPFs demonstrate that the expected number of crashes increases as traffic volume increases.

The advantages of this method are more accurately calculating the potential for safety improvement and acknowledging the complex, non-linear relationship between crash frequency and volume. Disadvantages are that this method is relatively complex and still does not acknowledge the random variation of crashes.

As part of the HSM, SPFs for intersections have been developed based on data obtained from a number of states in the U.S. Chapter 10, 11, and 12 of the HSM include these SPFs. The SPFs in the HSM were classified based on the surrounding area land-use (i.e., rural, suburban, and urban), geometric configuration of intersections (i.e., 3-leg and 4-leg), traffic control device of intersections (i.e., traffic signal and stop control), and functional classification of the main roadway.

It is advisable to develop SPFs for intersections in each jurisdiction based on the local intersection characteristic (e.g., number of approaches, traffic control device, and adjacent land-use). Road agencies require intersection characteristic data, traffic volume in the form of entering AADT volumes, and crash data. The traffic volume data and crash data need to be available for 3 to 5 years for each location. It should be noted that SPFs can be borrowed from similar jurisdictions (jurisdictions with the same network characteristics, traffic characteristics, weather conditions, driver population, and driving behavior).

6.3.7 Excess Expected Average Crash Frequency with Empirical Bayes Adjustment

Each of the above methods only considers past crash history, either by ranking and selecting a candidate site for further crash analysis or by determining whether a particular intersection under study has a crash problem. Using crash history alone is flawed because the frequency of crashes from year to year will randomly fluctuate about a long-term average (regression to the mean). Improved methods have evolved that identify high-risk sites that may benefit from remedial treatment(s), particularly the empirical Bayes (EB) method. Many jurisdictions are already employing the EB method.

The EB method calculates expected crash frequencies through a combination of observed and predicted crash frequencies. The predicted crash frequencies are derived through the development of an SPF.

The pivotal concept upon which contemporary methods for conducting proper road safety evaluations depend is the EB method. It is superior to traditional methods because it:

- Considers regression to the mean.
- Produces more stable and precise estimates of safety.
- Allows for estimates over time of expected crashes.

In case of a network screening for the entire jurisdiction, excess expected average crash frequency is calculated for all intersections in the study area. Expected crash frequency is the difference between the expected collision frequency and the predicted collision frequency, which is obtained from the SPF. The predicted collision frequency represents the overall safety performance of similar intersections. If a site has positive excess, it shows that the site has a potential for safety improvement and merits further detailed investigation. In a network screening exercise, sites are ranked based on their excess crash frequency. The same approach can be used to identify whether further analysis is warranted for a specific intersection.

6.3.8 Summary

The above section detailed various methods of assessing the safety of a location through consideration of its crash history and comparison with other similar sites. Care must be taken to ensure that the site is being compared with sites that should have a similar level of safety (i.e., sites with a traffic signal and the same number of legs). Methods such as crash frequency and crash rate may provide a simple and quick way of diagnosing a potential safety problem, but should be used with caution. The traffic engineer may consider using the critical rate method or the EPDO average crash frequency method as these provide a more balanced assessment of safety. Developing an SPF, either on its own or for use in applying to the EB method, is a much more sophisticated method of evaluating safety at a site. Given the availability of SPFs in many jurisdictions in the U.S. and Canada, as well as through the HSM, road agencies are encouraged to use the excess expected average crash frequency with EB adjustment methodology for network screening. Exhibit 6-3 presents a summary of the relative merits and drawbacks of each method.

Method	Advantages	Disadvantages
Average crash frequency	Simple to use Easy for the public to understand	Biased toward high-volume sites Does not consider exposure Severity not considered Regression to the mean not addressed
Crash rates	Simple to use Considers exposure	Biased toward low-volume sites Requires volume data Assumes crashes and volume have linear relationship Severity not considered Regression to the mean not addressed
Critical rate	Relatively simple Considers exposure Applies a recognized statistical method	Requires volume data Assumes crashes and volume have linear relationship Severity not considered Regression to the mean not addressed
Equivalent property damage only average crash frequency	Relatively simple Considers crash severity	Does not account for exposure May overemphasize sites with a low frequency of severe crashes depending on weighting factors used Regression to the mean not addressed
Excess predicted average crash frequency using safety performance	More accurate Considers exposure Acknowledges that crashes and volume have a nonlinear relationship	Requires volume data Regression to the mean not addressed Labor intensive Difficult for public to conceptualize
Excess expected average crash frequency with empirical Bayes adjustment	Most accurate Considers exposure Acknowledges that crashes and volume have a nonlinear relationship Addresses regression to the mean	Requires volume data Difficult for public to conceptualize

Exhibit 6-3. Common methods of assessing safety at a location.

6.3.9 Case Study

The purpose of this case study is to show the application of the network screening step of the road safety management process. This case study will be completed throughout this chapter as other steps of the road safety management process are described.

A County has conducted network screening using the excess expected average crash frequency with EB adjustment methodology for all signalized intersections within the county. Exhibit 6-4 shows the results of the network screening for the top 10 intersections that have been ranked based on Potential for Safety Improvement (PSI). The PSI is the difference between expected crashes (obtained from the EB method) and predicted crashes (obtained from SPFs).

This table is a typical output of a network screening exercise. The county then chooses to further analyze these intersections to address potential safety issues. As a case study, the first intersection presented in this exhibit STREET A @ ROAD B will be further analyzed and referred to throughout this chapter.

Rank	Description	Average AADT Major	Average AADT Minor	Intersection Type	Traffic Control	Study Period (Years)	Total Observed Crashes	Total Predicted Crashes	Total Expected Crashes	Potential for Safety Improvement (PSI)
1	STREET A @ ROAD B	27299	11341	4-legged	Signalized	5	90	52.337	87.610	35.273
2	STREET G @ ROAD H	30584	2935	4-legged	Signalized	5	42	19.599	38.568	18.969
3	STREET P @ ROAD Q	27154	3258	4-legged	Signalized	5	38	19.672	35.201	15.529
4	STREET R @ ROAD S	36966	5045	4-legged	Signalized	5	47	33.884	45.757	11.873
5	STREET A @ ROAD D	8132	4711	4-legged	Signalized	5	26	11.920	22.772	10.852
6	STREET E @ ROAD F	39732	8639	4-legged	Signalized	5	64	54.090	63.390	9.300
7	STREET G @ ROAD Q	52765	18028	4-legged	Signalized	5	122	115.747	121.814	6.067
8	STREET R @ ROAD H	27815	3773	4-legged	Signalized	5	28	22.414	27.237	4.823
9	STREET C @ ROAD D	38180	4506	4-legged	Signalized	5	37	31.683	36.465	4.782
10	STREET C @ ROAD F	32025	25576	4-legged	Signalized	5	113	109.720	112.897	3.177

Exhibit 6-4. Top 10 ranked signalized intersections in a county.

6.4 DIAGNOSIS

The previous section discussed different tools used to select a candidate intersection for a safety evaluation. At a certain point, the traffic engineer will conclude, based on past crash history, that there is a safety concern and a significant potential for safety improvement at the location in question. It should be noted that some traffic engineers may have completely bypassed the entire first step of this process (in determining a candidate intersection for safety improvements) because they have been asked to carry out a safety analysis of an intersection due to:

1. Safety complaints or concerns raised by others (other departments, local politicians, the public).
2. Planned reconstruction that would make it worthwhile to carry out a safety evaluation and improvements.
3. Identified operational deficiencies.

This section will discuss how the traffic engineer may correctly diagnose what types of safety problems/issue may be present at an intersection. Diagnosis of a particular safety concern can then lead to appropriate countermeasures.

The following four-step process can be used to diagnose safety problems at a site:

- Step 1 – Conduct Safety Data Review.
- Step 2 – Assess Supporting Documentation.
- Step 3 – Assess Field Conditions.
- Step 4 – Define Problem Statement(s).

The above process is consistent with the recommendations of Chapter 5 of the HSM.

6.4.1 Step 1 – Conduct Safety Data Review

In conducting a safety diagnosis at a signalized intersection, the traffic engineer seeks to understand any patterns in the crash data and identify contributing factors of crashes within the functional boundary of the intersection.

The safety data review can be conducted in three stages:

1. Assemble crash data.
2. Describe crash statistics.
3. Summarize crashes by location.

Assemble Crash Data

Crash data used for diagnosing safety at a signalized intersection should represent 3 to 5 years of crash data. It should include all crashes reported as occurring at or related to the intersection's influence zone. The relationship of crashes to intersections is often expressed in the Model Minimum Uniform Crash Criteria (MMUCC) Guideline⁽⁷⁴⁾ in "Relation to Junction."

Most agencies have electronic databases from which the following characteristics of crashes associated with the subject intersection can be extracted:

- Crash identifiers such as date, time of day, and time.
- Severity: which is often represented in the KABCO scale, defined as follows:
 - K-Fatal injury: an injury that results in death.
 - A-Incapacitating injury: any injury, other than a fatal injury, that prevents the injured person from walking, driving, or normally conducting the activities the person was capable of performing before the injury occurred.

- B-Non-incapacitating evident injury: any injury, other than a fatal injury or an incapacitating injury, that is evident to observers at the scene of the crash in which the injury occurred.
- C-Possible injury: any injury reported or claimed that is not a fatal injury, incapacitating injury, or non-incapacitating evident injury and includes claim of injuries not evident.
- O-No Injury/Property Damage Only (PDO).
- Crash Type.
 - Rear-end.
 - Sideswipe.
 - Angle.
 - Turning.
 - Head-on.
 - Fixed object.
- Direction of travel before crash.
- Sequence of events.
- Contributing circumstances:
 - Parties involved – vehicle only, pedestrian and vehicle, bicycle and vehicle.
 - Road condition at the time of the crash – dry, wet, snow, ice.
 - Lighting condition at the time of the crash – dawn, daylight, dusk, dark-lighted, dark-not lighted.
 - Weather condition at the time of the crash – clear, cloudy, fog, rain, snow, ice.
 - Impairments of parties involved – alcohol, drugs, fatigue.

If available, the original police reports should be used to gather anecdotal comments written by police officers at the crash scene and firsthand accounts of the crashes from involved parties and eyewitnesses.

Describe Crash Statistics

Once crash data for the intersection has been extracted from the database, it is important to identify patterns and potential contributing factors from the historical crash data. Three techniques are often used by practitioners to identify crash patterns and contributing factors of crashes in a safety diagnosis exercise:

1. Develop visualization tools – graphs and charts can assist the traffic engineer in visualizing crash frequencies in terms of various crash attributes.
2. Conduct a crash cluster analysis – the crash cluster analysis process involves a manual screening of crash attributes. In this type of analysis, the object is to identify crash clusters for each crash attribute, such as crash impact type, road surface condition, lighting condition, etc.
3. Conduct over-representation analysis – over-representation analysis is used to determine whether the proportion of a characteristic found at a specific intersection is the same as that found in a group of similar sites. Identification of abnormal trends can lead toward possible solutions. To ensure that the determination of overrepresentation is valid, appropriate statistical techniques should be employed. The chi-square method is one of the methods for identifying over-representation at a site. The HSM refers to this analysis as “Specific Crash Types Exceeding Threshold Proportion,” and details of this technique can be found in Chapter 4 of the HSM.

The crash characteristics should be reviewed for over-representation through comparison with crash characteristic information representing the typical experience of a signalized intersection. Examples of questions that can be answered by the above three techniques to identify over-representations or patterns in the crash attributes are highlighted below.

An examination of crash pattern by season, day of week, or time of day may be helpful in finding patterns that relate to the general travel patterns of road users passing through the intersection. Seasonal patterns, indicating a higher-than-expected proportion of crashes occurring during a particular time of year, may coincide with an influx of unfamiliar drivers to an area—as may be the case in resort areas and/or areas with a significant number of tourist attractions. Day of week and time of day patterns should be examined. Morning/afternoon weekday over-representation may suggest crash patterns related to commuting traffic (coinciding with the morning and afternoon rush hours). A late night/early morning/weekend overrepresentation may suggest problems with drunk drivers.

Over-representation in crash severity will highlight a location that has an unusually high proportion of fatal and/or injury crashes. A higher proportion of fatal and/or injury crashes may suggest a problem with higher operating speeds.

Summarize Crashes by Location

The end product of the descriptive crash statistics will be a set of characteristics identified as being over-represented. The next step is to relate the patterns and over-represented characteristics of crashes to a particular approach. A crash diagram can be used to create such relationship. A crash diagram is a two-dimensional plan view representation of the crashes that have occurred at a site within a given time period. In a crash diagram, each crash type is represented by combinations of arrows and symbols. Exhibit 6-6 shows proposed symbols for classification of various crash types.

6.4.2 Step 2 – Assess Supporting Documentation

The main goal of this step is to gather and review documented information or personal opinion about the site. This information can be gathered from previous studies relevant to the subject intersection, complaints filed with the road agency by residents, or consultation with the authorities who have local knowledge about the study area. This is an important step in which the crash patterns can be studied in the context of the past changes in the study area. For example, an increase in pedestrian crashes in the past 3 years can be correlated with the opening of a new school in the vicinity of the subject intersection 3 years ago.

The HSM suggests that the following types of information may be useful as supporting documentation to the diagnosis of safety problems at a site:

- Current traffic volumes for all travel modes.
- As-built construction plans.
- Relevant design criteria and pertinent guidelines.
- Inventory of field conditions (e.g. traffic signs, traffic control devices, number of travel lanes, posted speed limits, etc.).
- Relevant photos.
- Maintenance logs.
- Recent traffic operations or transportation studies conducted in the vicinity of the site.
- Land use mapping and traffic access control characteristics.
- Historic patterns of adverse weather.
- Records of public comments or complaints on transportation issues.
- Roadway improvement plans in the site vicinity.
- Anecdotal information about travel through the site.

Appendix 5B of the HSM provides a list of questions and data to consider when reviewing past site documentations.

6.4.3 Step 3 – Assess Field Conditions

To supplement the analysis and diagnosis using crash data, a site visit or series of site visits should be undertaken. Before initiating site visit(s), the study team should be aware of:

- Whether certain crash characteristics were over-represented based on the analysis of crash over-representation.
- Which areas within the intersection's sphere of influence are showing unusual clusters of crashes.
- If available, what operational problems have been identified as part of the operational analysis.

The purpose of the site visit is to gather additional information that can aid in pinpointing potential underlying cause or causes of the abnormal crash patterns (Exhibit 6-6). The site visit should be undertaken to:

- Observe driver/road user behavior during the following conditions:
 - Peak and off-peak periods.
 - Evening/night (as necessary).
 - Wet weather (as necessary).
 - Weekend and special events (as necessary).
- Photograph relevant features. Consideration may be given to using video recording to capture each intersection approach from the driver's perspective.
- Review the site from the perspective of all users, including motorists, pedestrians, and bicyclists. This includes observing motorist, bicyclist, and pedestrian circulation and identifying origins and destinations in the vicinity.
- Check for physical evidence of crashes or near-crashes, such as vehicle damage to street furniture, signs and other objects near the roadway, skid marks on the intersection approaches, and tire marks on the shoulder or ground adjacent to the roadway.
- Conduct a conformance/consistency check: an assessment of signs and traffic control, markings, delineation, geometry and street furniture to ensure standard application and consistency and that all traffic control devices are in conformance with local, State, and Federal standards.

One of the key tasks the study team will wish to conduct during the site visit is a positive guidance review.⁽⁹⁾ A positive guidance review uses an in-depth knowledge of human factors and the driving task to screen roadways for:

- Information deficiencies.
- Expectancy violations.
- Workload issues.

Each of the above may contribute to the occurrence of driver error and crashes.

Information deficiencies occur when information that the driver needs to carry out the driving task safely is missing. An example may be inadequate signing/pavement marking for a designated right-turn lane that traps drivers intending to proceed straight. Attempts to move over to the through lane can cause queuing and possible rear-end and sideswipe conflicts.

Expectancy violations occur when a driver encounters a traffic control or roadway design that conflicts with his or her expectations. The traffic engineer should structure expectancies about treatments at similar locations.⁽⁷⁵⁾ The key to effective expectancy structuring is uniformity and standardization.

Standard devices that are inconsistently applied can create expectancy problems for drivers. A prime example of this is the use of a left-hand exit amidst a series of right-hand exits. Positive guidance seeks to address this expectancy violation through clearly communicating to the driver that a left-hand exit is ahead.

Workload issues occur when the driver is bombarded with too much information, increasing the likelihood of error. This may occur at an intersection with an abundance of signing, pavement markings, traffic signals, and pedestrian and bicycle activity. All of the above may be further complicated if the operating speed on the approaches is high, giving the driver even less time to sort through and comprehend what to do to get safely through the intersection and on to the intended destination. The traffic engineer should seek to reduce the complexity of the information the driver receives at the intersection or to spread information by using advance signs.

Although positive guidance techniques are generally applied to the driving task, these concepts and tools can easily be considered from the perspective of all road users. Positive guidance is a holistic approach treating the roadway, the vehicle, and the driver as a single, integrated system. It recognizes drivers as the information gatherers and decision-makers within the system and focuses attention on assuring that they get the information they need, when they need it, in a form they can understand, in time to make rapid, error-free decisions and take appropriate actions. Creating and sustaining a supportive information environment on the roadway is the goal of positive guidance.

In conducting a positive guidance review, the analyst attempts to view the roadway through the eyes of an average driver, postulating what the driver's perceptions, interpretations, expectations, and actions might be. This is done to formulate theories and possible explanations regarding the cause or causes of previous or potential conflicts and/or crashes.

Positive guidance normally focuses on low-cost, information-oriented improvements that can be implemented quickly, either as solutions in and of themselves or as interim improvements until a more definitive solution can be achieved. It may also identify the need for additional investigation, in the form of conventional engineering analysis, to support theories regarding the contributory causes of crashes, and to justify mitigation measures.

Appendix 5C of the HSM provides a process required for preparation for a field assessment undertaking, and Appendix 5D of the HSM provides a field review checklist for signalized intersections.

It should be noted that an RSA, which was described in the qualitative approach for safety review of signalized intersections, always includes a field review for existing intersections (obviously a field review is not possible for intersections in planning and design stages). The process for conducting an RSA field review described in this section can be followed.

6.4.4 Define Problem Statement(s)

A set of one or more clear problem statements should be developed. The problem statement(s) are developed on the basis of the crash analysis (i.e., evidence of over-representation among a crash subgrouping) and should be supported through the site visit and any further analysis. The problem statement should correlate crash patterns observed with potential contributing factors.

The problem statement helps clearly define safety concerns at the location. Circumstances associated with these safety concerns may be mentioned along with possible causal factors. The problem statement may be multifaceted and encompass the physical and/or operational attributes of the intersection, road user behavior and/or actions, environment and/or temporal conditions, as well as transitory or peripheral events. In many instances, the study team will identify several problems or issues.

Example problem statements are given in Exhibit 6-5.

Problem Statement #1

Rear-end crashes and crashes occurring between 3 and 6 p.m. are over-represented. The crash diagram shows that almost all of these occur on the westbound approach. Based on the site visit, the initial problem statement is that these are occurring due to:

- Lack of traffic signal visibility for westbound drivers.
- Movement into and out of a commercial driveway on the near side of the intersection.
- A polished pavement surface on this approach.
- Glare from the afternoon sun.

Problem Statement #2

Fatal and injury crashes were over-represented, and four fatal or injury crashes involved pedestrians. The crash diagram indicates that all occurred on the southwest corner of the intersection and are related to the right-turn lane channelization. Based on the site visit and subsequent further analysis, the initial problem statement is that these are occurring due to:

- The design of the right-turn channelization operating under YIELD control, which contributes to excessive driver speed.
- Drivers failing to yield to pedestrians.
- The presence of a bus shelter that partially blocks the view of the crosswalk.

Exhibit 6-5. Example problem statements.

















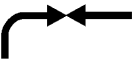
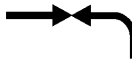



			
REAR END	HEAD ON	SIDESWIPE, SAME DIRECTION	SIDESWIPE, OPPOSITE DIRECTION
			
OVERTAKING	RIGHT TURN, REAR END	RIGHT TURN, ONCOMING	LEFT TURN, ONCOMING
			
LEFT TURN, REAR END	LEFT TURN, OPPOSING THRU	RIGHT ANGLE	RIGHT TURN, SIDESWIPE
			
THROUGH WITH RIGHT	LEFT TURN, SIDESWIPE	THROUGH WITH LEFT	LEFT AND RIGHT TURN, SIDESWIPE
			
SINGLE VEHICLE WITH PARKED CAR	SINGLE VEHICLE WITH OTHER THAN PARKED CAR	VEHICLE WITH PEDESTRIAN	VEHICLE WITH BICYCLE
			
BICYCLE WITH PEDESTRIAN	OTHER		

Exhibit 6-6. Possible taxonomy for crash type classification.

6.4.5 Case Study

The purpose of this case study is to show the application of the diagnosis step of the road safety management process.

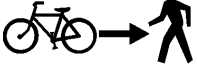
The intersection of Street A and Road B (shown in Exhibit 6-7) was ranked first in the network screening exercise of all 4-leg signalized intersection in the county, as shown in the previous section. It

was identified that the potential for safety improvement is 35.3 crashes per a 5 year period. The intersection characteristics include:

Geometric Characteristics

Street A (a major east-west arterial roadway), immediately east of Road B, is essentially flat and straight vertically and horizontally; to the west of Road B, Street A contains a horizontal curve and vertical curve. The vertical curve exists immediately west and in advance of the intersection, resulting in a vertical crest for eastbound approaching road users. Road B (a minor north-south arterial roadway) is essentially flat and straight on the approach to Street A.

Traffic Control

The intersection contains two mast arm-mounted primary signal displays for the through movements and a secondary signal display for the left-turning movements on all approaches. The signals are both horizontally and vertically located within the required mounting field of view, as per the FHWA MUTCD. The signal displays contain three-section, vertically arranged signal bulbs comprised of circular red, yellow, and green indications and are positioned over the appropriate lanes based on FHWA MUTCD 2009 guidance.⁽¹⁾

Signing

Regulatory speed limit signs are present on all approaches to the intersection. Street name signs both for Street A and Road B are present on the primary signal pole for all approaches (far right quadrant of the intersection). Advance street name signing is present on both northbound and southbound approaches to the intersection. Signal ahead warning signs are present on the northbound and southbound approaches to the intersection. The signs are all located appropriate distances upstream of the intersection.



Exhibit 6-7. Study intersection.
Source: Google, 2012

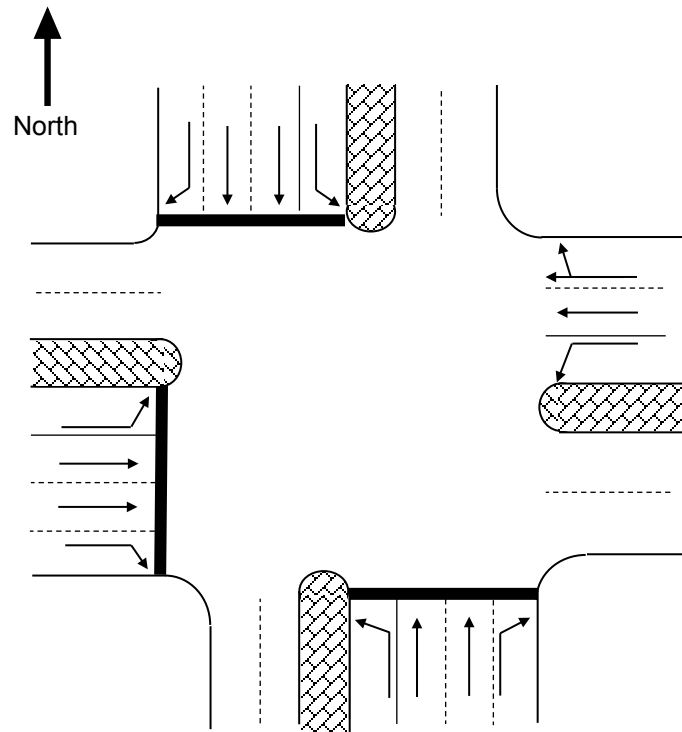

Exhibit 6-8. Lane configuration of the study intersection.

Step 1 – Safety Data Review

Assemble Crash Data

The County has provided crashes for the period of 2006 to 2010 to the traffic engineer. Exhibit 6-9 provides a summary of crashes in terms of severity, and Exhibit 6-10 shows the same crashes in terms of their impact type.

Crash Severity	Year					Total
	2006	2007	2008	2009	2010	
Fatal/Injury	3	10	8	1	3	25
PDO	10	15	18	14	8	65
Total	13	25	26	15	11	90

Exhibit 6-9. Crashes in the study intersection from 2006 to 2010, by severity.

Row Labels	2006	2007	2008	2009	2010	Grand Total
Angle	2	2	3	2	1	10
Rear End	6	14	14	8	5	47
Sideswipe	1	3	3	1	2	10
Turning	4	6	6	4	3	23
Grand Total	13	25	26	15	11	90

Exhibit 6-10. Crashes at the study intersection from 2006 to 2010, by impact type.

Descriptive crash statistics

Exhibit 6-11 shows crash frequencies in terms of crash types and road surface condition. Based on this exhibit, a significant number of rear-end and turning movement crashes have been identified at this intersection. There is also potential concern regarding the number of crashes during wet and slippery road surface conditions. However, to confirm whether such a problem exists, the proportions of road surface condition crashes at this intersection should be compared to similar intersections (over-representation analysis).

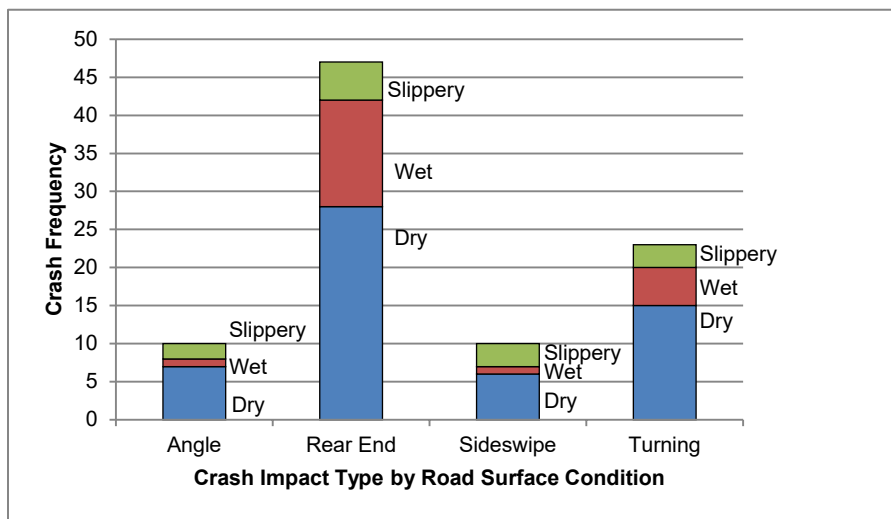

Exhibit 6-11. Crash frequencies in terms of crash impact types and road surface conditions.

Exhibit 6-12 shows crash frequencies in terms of crash impact types and light condition. This exhibit shows that most crashes occur during daylight. There might be some concerns related to turning movement crashes during dark hours of days. To be confident about these findings, an over-representation analysis should be conducted.

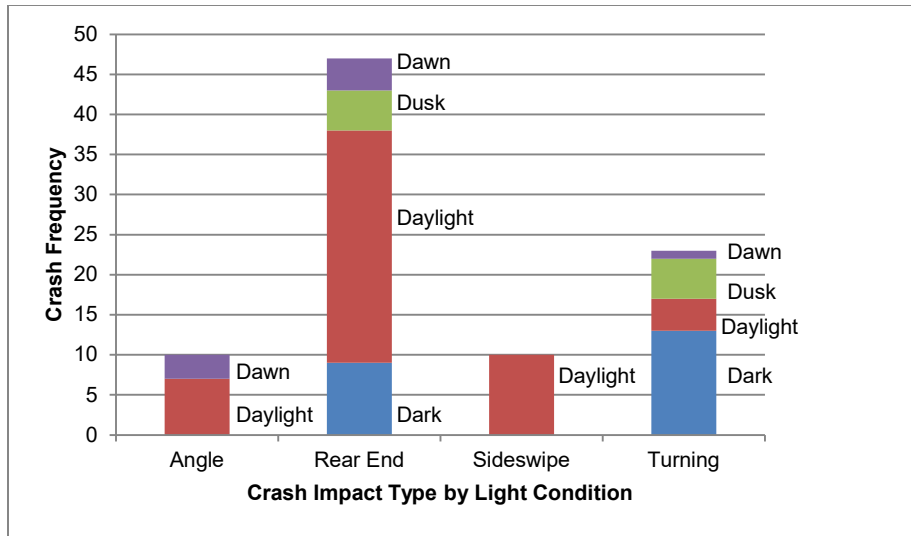

Exhibit 6-12. Crash frequencies in terms of crash impact types and light conditions.

The results of the proportional analysis (over-representation analysis) showed that the following crash attributes are over-represented at the study intersection:

- Angle crashes.
- Rear-end crashes.
- Turning movement crashes.
- Wet road surface condition.

Summarizing Crashes by Location

Exhibit 6-13 illustrates the crash diagram associated with the study area. In this diagram the crashes reviewed in the previous stage are related to each approach of the intersection. Different crash impact types are shown with different symbols. The number shown beside each crash cluster shows the number of crashes per each cluster. Red arrows in this diagram represent the at-fault vehicles. The crash diagram shows that most turning movements have occurred between eastbound left-turning vehicles and westbound through vehicles. Rear-end crash clusters dominantly exist on east and west approaches of the intersection. Angle crashes have occurred between southbound through vehicles and westbound through vehicles.

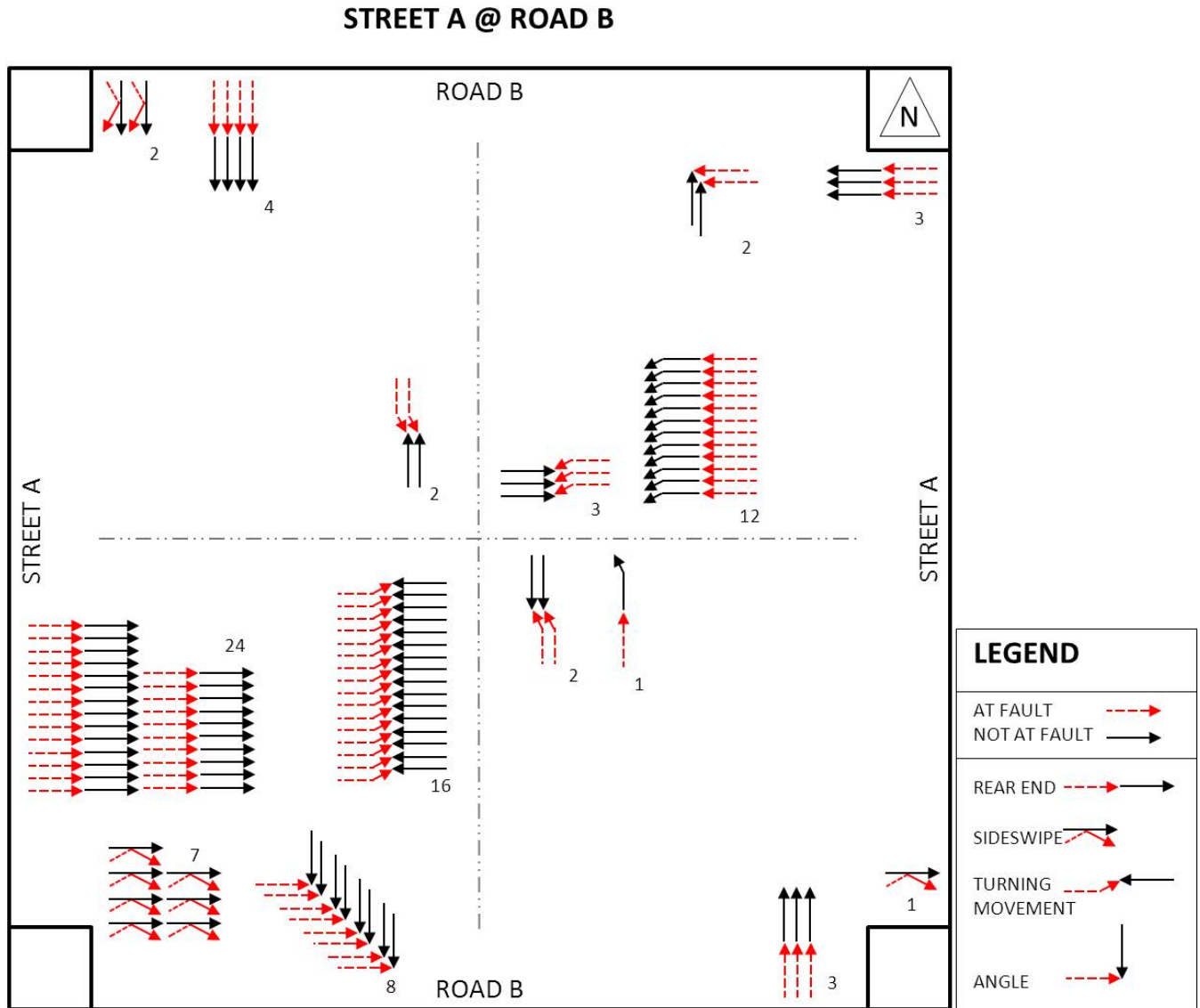

Exhibit 6-13. Crash diagram for the intersection of Street A and Road B.

Step 2 – Assess Supporting Documentation

- Speed limit on all approaches to the intersection is 35 mph.
- Entering AADT of the intersection is 53,866.
- The County has indicated that the following guidelines and manuals are relevant in this study:
 - The geometric design guideline pertinent to the study is the AASHTO Green Book – A Policy on Geometric Design of Highways and Streets.
 - All signing and other traffic control devices must conform to the latest edition of the MUTCD.
- Consultation with the County’s traffic engineer revealed that the westbound left-turning vehicles have capacity challenges.

Step 3 – Assess Field Conditions

Exhibit 6-14 presents the findings of the field investigation. The field visit consisted of peak and off-peak visits as well as visits during day light and dark lighted.

Location	Findings
Street A, just west of and on approach to Road B	<ul style="list-style-type: none"> • Signal displays are inconspicuous on approach (signal bulbs are dull, and back plates are inconspicuous at night). • Vertical crest curve in advance of intersection – stopping sight distance measured and is inadequate. • Exclusive eastbound right-turn exit lane exists; however, no exclusive turn lane signs exist. Due to vertical crest curve, it is difficult to determine the lane configuration on intersection approach for drivers. • Polished and worn pavement surface on intersection approach. • The street name sign at the intersection is being obscured by auxiliary signal pole for opposing direction. • No advance street name signs exist on intersection approach. • No advance intersection ahead warning signs exist on intersection approach • Road user interactions (eastbound): red light running; high travel speeds (well in excess of posted speed limit); uncertain maneuvers made by road users, potentially due to non-present advance notice (signage); conflicts (near-misses) between eastbound road users, potentially leading to rear-end type as well as eastbound left-turning with westbound through-turning movement type crashes.
Street A @ Road B	<ul style="list-style-type: none"> • Road user interactions (westbound): conflicts (near-misses) between westbound left-turning and through-bound road users (potentially leading to rear-end type crashes).

Exhibit 6-14. Field investigation findings.

Step 4: Define Problem Statement

Exhibit 6-15 summarizes problem statements associated with the intersection of Street A and Road B. The crash patterns and over-represented crashes identified in Step 1 of the diagnosis process are correlated with potential contributing factors identified through assessment of supporting documents and assessment of field conditions.

Crash Attributes	Problem Statement
<p>Angle: Eastbound through at fault, with southbound through movements.</p> <p>Rear-end: Westbound through at fault, with westbound left-turn movements.</p> <p>Turning movement: Eastbound left-turn at fault, with westbound through movements.</p> <p>Rear-end: Westbound through at fault, with westbound left-turn movements.</p> <p>Wet Road Surface Conditions: Westbound through vehicles contributing to rear-end crashes.</p>	<p><u>Street A just west of, and on approach to, Road B</u></p> <ul style="list-style-type: none"> • Signal displays are inconspicuous on approach (signal bulbs are dull, and back plates are inconspicuous at night). • Vertical crest curve in advance of intersection – stopping sight distance measured and is inadequate. • Exclusive eastbound right-turn exit lane exists, however, no exclusive turn lane signs exist. Due to vertical crest curve, it is difficult to determine the lane configuration on intersection approach. • Polished and worn pavement surface on intersection approach. • The street name sign at the intersection is being obscured by auxiliary signal pole for opposing direction. • No advance street name signs exist on intersection approach. • No advance intersection ahead warning signs exist on intersection approach. • Road user interactions (eastbound): red light running; high travel speeds (well in excess of posted speed limit); uncertain maneuvers made by road users, potentially due to non-present advance notice (signing); conflicts (near-misses) between eastbound road users, potentially leading to rear-end type as well as eastbound left-turning with westbound through-turning movement type crashes, <p><u>Street A @ Road B</u></p> <ul style="list-style-type: none"> • Road user interactions (westbound): conflicts (near-misses) between westbound left-turning and through-bound road users (potentially leading to rear-end type crashes).

Exhibit 6-15. Problem statements.

6.5 SELECTING COUNTERMEASURES

After diagnosis, the next step in the road safety management process is countermeasure selection. The end product of the diagnosis process is one or more problem statements in which a crash pattern is related to a number of potential contributing factors. The objective of the countermeasure selection step is to develop countermeasures to address the contributing factors identified as part of the diagnosis step.

Countermeasures include all measures likely to decrease the frequency or severity of crashes identified as exhibiting an abnormal pattern (over-representation).

In Part III of this guide, the reader will find countermeasures (treatments) organized into five broad groups:

- System-wide treatments (Chapter 8).
- Intersection-wide treatments (Chapter 9).
- Approach treatments (Chapter 10).
- Individual movement treatments (Chapter 11).

For each treatment, there are references to possible crash groups that are likely to be positively affected through a treatment's implementation. At signalized intersections, the following crash patterns are most commonly identified:

- Rear-end crashes.
- Angle crashes.
- Left-turn or right-turn movement crashes.
- Nighttime crashes.
- Wet pavement crashes.
- Crashes involving pedestrians and bicyclists.

Exhibit 6-16 presents possible contributing factors and countermeasures for each of these types, along with the appropriate chapter.

The material presented in this section provides a range of options that could be selected, but is not fully comprehensive. It is not possible to develop a complete list of all potential crash treatments, because new tools and techniques for improving traffic safety are constantly being developed and adopted. It is important that the study team not limit itself to existing lists or tables of treatments. The team should consider a wide range of treatments (including those based on local practice) that may be beneficial, particularly when the crash pattern identified represents a unique situation.

Over the course of the above crash diagnostic analysis, site visits, and field analysis, the traffic engineer may have identified treatments that are of little cost and undoubtedly beneficial to improving safety at the intersection. Such treatments may relate to repairing sidewalks, removing sight obstructions, reapplying faded pavement markings, and relocating or adding new signs. These may be implemented without going through the process described below.

Crash Type	Possible Contributing Factors	Possible Treatment Group (Chapter)
Rear-end crashes	<ul style="list-style-type: none"> Sudden and unexpected slowing or stopping when motorists make left turns in and out of driveways along corridor. 	<ul style="list-style-type: none"> Median treatments (Chapter 8)
	<ul style="list-style-type: none"> Sudden and unexpected slowing or stopping when motorists make right turns in and out of driveways along corridor. 	<ul style="list-style-type: none"> Access management (Chapter 8)
	<ul style="list-style-type: none"> Too much slowing and stopping along corridor due to turbulent traffic flow. 	<ul style="list-style-type: none"> Change signal control from pre-timed to actuated (Chapter 9)
	<ul style="list-style-type: none"> Too much slowing and stopping along intersection approaches due to traffic-control issues. Drivers caught in intersection during red phase due to inadequate traffic control or inadequate change and clearance interval. Traffic signal not conspicuous or visible to approaching drivers, causing sudden and unexpected slowing or stopping movements. 	<ul style="list-style-type: none"> Change signal control from pre-timed to actuated (Chapter 9) Red light camera enforcement (Chapter 10)
	<ul style="list-style-type: none"> Sudden and unexpected slowing or stopping due to inadequate intersection capacity. 	<ul style="list-style-type: none"> Change signal control from pre-timed to actuated (Chapter 9) Individual movement treatments (Chapter 11)
Angle crashes	<ul style="list-style-type: none"> Drivers caught in intersection during red phase due to inadequate traffic control or inadequate change and clearance interval. Traffic signal not conspicuous or visible to approaching drivers, causing drivers to get caught in intersection during red phase. Drivers caught in intersection during red phase due to inadequate warning/inability to stop. 	<ul style="list-style-type: none"> Modify change and clearance intervals (Chapter 9) Increase size of signal; Add supplemental signal heads; Provide backplates (Chapter 10)
Left-turn crashes	<ul style="list-style-type: none"> Intersection cannot accommodate left-turn movements safely. 	<ul style="list-style-type: none"> Add single or multiple left-turn lane (Chapter 11) Restrict turns (Chapter 11)
Nighttime related Crashes	<ul style="list-style-type: none"> Poor nighttime visibility or light. Poor sign visibility. Inadequate channelization or delineation. Inadequate maintenance. Excessive speed. Inadequate sight distance. 	<ul style="list-style-type: none"> Provide or upgrade illumination (Chapter 9) Add channelizing islands (Chapter 10)
Wet pavement related crashes	<ul style="list-style-type: none"> Slippery pavement Inadequate pavement markings Inadequate maintenance Excessive speed 	<ul style="list-style-type: none"> High visibility crosswalks. (chapter 9) Improve pavement surface. (chapter 10)
Crashes or conflicts involving bicyclists and pedestrians	<ul style="list-style-type: none"> Either the intersection cannot safely accommodate the pedestrians and/or bicyclists, or motorists are failing to see or yield to their movements. 	<ul style="list-style-type: none"> Pedestrian, bicycle, and/or transit improvements (Chapter 9)

Exhibit 6-16. Crash types commonly identified, possible causes, and associated treatments.

The practitioner should generate a list of countermeasures (some of which may have been identified in this guide) that are based on local practice or are representative of a unique situation identified at the intersection through the diagnosis step. Before conducting the economic appraisal of each countermeasure, it is advisable to screen the countermeasures to narrow the options for the economic appraisal step.

The practitioner should generate a list of countermeasures (some of which may have been identified in this guide) that are based on local practice or are representative of a unique situation identified at the

intersection through the diagnosis step. Before conducting the economic appraisal of each countermeasure, it is advisable to screen the countermeasures to narrow the options for the economic appraisal step.

One method of screening proposed countermeasure is to develop a matrix where each treatment is given a score within different categories based on the consensus among study team members. The individual score categories may be as follows:

- **Overall Feasibility:** How feasible would it be to implement the countermeasure? Would it involve a significant amount of work, time and/or coordination with police, maintenance staff, transportation planners, or the public? Straightforward treatments get positive scores. Difficult-to-implement countermeasures get negative scores.
- **Impact on Traffic Operations:** Is the countermeasure expected to improve the flow of traffic within the intersection influence area? Countermeasures that would improve traffic operations score positive. Countermeasures that would degrade traffic operations score negative.
- **Consistency with Local Practice:** Is the countermeasure consistent with local practice? Countermeasures that are familiar to the public and have known benefits score positive. Countermeasures that are unfamiliar and are largely untested score negative.

Scoring each countermeasure allows the study team to quickly determine which treatments are expected to have a positive or negative effect on the intersection. The long list of potential countermeasures then can be reduced to a short list of viable countermeasures. Based on a threshold score decided upon among the study team, the countermeasures may then be screened and those scoring poorly may be discarded.

6.5.1 Case Study

For the case study presented in the diagnosis step, Exhibit 6-17 shows a list of countermeasures proposed for the study intersection that can potentially address safety problems identified in the problem statements.

Countermeasure	Description
Heighten conspicuity of the signal displays for eastbound intersection-approaching road users.	<p>This countermeasure involves installation of devices to heighten the conspicuity of the signal displays for road users approaching the intersection along Road B. The following treatments are recommended:</p> <ul style="list-style-type: none"> • Install new signal bulbs and ensure they are conspicuous to intersection-approaching road users. • Install the recommended one signal per lane over each lane. • Install yellow retroreflective sheeting border on the eastbound traffic signal display back plates.⁽⁷⁶⁾
Address stopping sight distance issues on eastbound approach to the intersection.	<p>Low-Cost Solution:</p> <p>This countermeasure involves installation of warning signage to heighten awareness of the sight distance issue on the intersection approach. The following treatments are recommended:</p> <ul style="list-style-type: none"> • Install either a "SIGNAL AHEAD" warning sign or a "BE PREPARED TO STOP" warning sign to heighten awareness of the presence of the

Countermeasure	Description
	<p>intersection on approach.</p> <p>High-Cost Solution:</p> <p>This countermeasure involves re-design and reconstruction of the vertical curvature of the roadway to ensure the stopping sight distance on approach to the intersection is met.</p>
Enhance presence of lane designation on eastbound approach to the intersection.	<p>This countermeasure involves the installation of lane designation signs and markings for exclusive eastbound right-turn lane to ensure lane designation is evident to intersection-approaching road users.</p>
Pavement friction test and potential follow-on construction work.	<p>This countermeasure involves conducting a friction test of the existing pavement surface. An empirical test of the friction properties of the pavement could determine if additional friction should be added to the pavement surface. Increasing pavement friction may assist road users' ability to maneuver during events leading up to a potential collision, particularly eastbound rear-end collisions.</p>
Installation/Relocation of street name signs	<p>This countermeasure involves enhancing the conspicuity of the standard street regulatory name sign for Road B by increasing the size of the sign and relocating it to a position over the curb-through lane on the signal mast arm.</p>
Further enhance the presence of Road B on approach along Street A.	<p>This countermeasure involves installation of signage to better inform approaching road users of the downstream condition and the subject signalized intersection so that they can make appropriate decisions about lanes, etc., and can enter with caution due to the existing issue with vertical geometry.</p> <p>Advance street name sign for Road B on eastbound approach.⁽⁷⁷⁾</p> <p>Conspicuity enhancement of the standard street regulatory name sign for Road B through increasing the size of the sign and relocating it to a position over the curb-through lane on the signal mast arm.</p>
Install INTERSECTION AHEAD warning sign.	<p>This countermeasure involves the installation of an INTERSECTION AHEAD warning sign to provide appropriate advance notice of the downstream condition to eastbound intersection-approaching road users.</p>
Install a westbound left-turn lane.	<p>This countermeasure involves the installation of a westbound left-turn lane at the intersection to remove westbound left-turning road users from the stream of through traffic.</p>

Exhibit 6-17. Proposed long list of countermeasures.

6.6 ECONOMIC APPRAISAL

Economic appraisals identify whether the countermeasures identified in the previous step of the road safety management process have larger benefits than their costs. The economic appraisal quantifies countermeasures' benefits in terms of their safety impacts. The ability to evaluate the safety impacts of a countermeasure is paramount to implementing an intersection improvement plan. Information is needed on whether the treatment under consideration is effective in reducing crashes. Most treatments proposed in Part III of this guide have some published material that provides a quantitative estimate of effectiveness. For other treatments in Part III, no research was found that provided any quantifiable estimate of safety benefits. Before any further consideration as to the applicability of a treatment can occur, the study team will need to decide whether they have a quantifiable estimate of the expected results of a treatment available. If they do, they can proceed with the steps described below. If not, they should carefully consider whether the treatment should be implemented.

The economic appraisals include three steps:

- Step 1: Estimate benefits of countermeasures.
- Step 2: Estimate costs of countermeasures.
- Step 3: Evaluate cost effectiveness of countermeasures.

6.6.1 Step 1 – Estimate Benefits of Countermeasures

To estimate the benefits of safety improvement projects (countermeasures), crash modification factors (CMF) are utilized. CMF is a term that is widely used in road safety engineering. A CMF is the ratio of expected crash frequency at a location with a countermeasure divided by the expected crash frequency at the location without the countermeasure. If the expected crash frequency with a treatment is 9 and the expected crash frequency without the treatment is 12, then the CMF is $9/12 = 0.75$.

Some jurisdictions have developed reference lists of CMFs to help them choose an appropriate treatment for an intersection improvement plan. In some cases, very little or no documentation exists showing how these CMFs were derived. Some State authorities are currently using CMFs developed from in-house projects; others use CMFs developed by other transportation authorities or based on published research. FHWA has developed the CMF Clearinghouse,⁽⁷⁸⁾ which houses a Web-based database of CMFs along with supporting documentation to help traffic engineers identify the most appropriate countermeasure for their safety needs. It is a live database in which new CMFs are added as they become available through research. The CMF clearinghouse has adopted a star rating to represent the quality of each CMF. A 5-star CMF represents a CMF that has been developed using a valid statistical methodology.

Part III of this guide reports study findings from a variety of sources. These findings reported a change in crash frequency or crash rate as part of a cross-sectional study, a before-after study, or by more sophisticated methods. Each study finding was reviewed in terms of:

- The reasonableness of the values presented.
- The year of the study.
- The general integrity of the study in terms of crash data used, methodology, and sample size.
- The country of origin.

In general, findings that appeared unreasonable, outdated, used overly simplistic methods, or were based on research carried out outside of North America (unless no other finding was available for the treatment in question) were discarded. The results are presented as the expected change in crash frequency, expressed as a percentage. A study finding of 50 percent means that there is expected to be a reduction of 50 percent in the number of crashes occurring after the application of the treatment the study finding describes. Each CMF or study finding in Part III of this guide is referenced. In applying a CMF or in finding ways to determine the expected outcome of implementing a treatment, the user is urged to review the source material from which the CMF or study finding was derived in order to determine its applicability to his or her specific project. Readers may wish to use their own CMFs or the results of another study

finding known to them should they believe that it is more accurate or better reflects conditions occurring at the location in question.

The target benefit of any countermeasure is a reduction in the frequency or severity of crashes. Assumptions regarding the potential benefit(s) of a countermeasure must be realistic. The crash frequency (or crash frequency of a specific group of crashes) cannot be driven below zero. To quantify the safety benefit of implementing a countermeasure, the estimated crash reduction that will be connected with the implementation of the countermeasure must be determined. If a countermeasure is successful in eliminating or reducing the severity of crashes that would have been expected without the countermeasure, then the benefits can be attributed to the countermeasure.

When two countermeasures are considered and each has a quantifiable safety benefit, a common way to express the combined safety benefit is to multiply both values. For example, countermeasure A might have a CMF of 0.90, and countermeasure B might have a CMF of 0.80. Combined, the two countermeasures should have an expected benefit of 0.72 (CMF A (0.90) x CMF B (0.80)).

Usually, countermeasures will only be effective when applied to a particular target group of crashes. For example, the installation of protected left-turn phasing on one approach should substantially reduce left-turn crashes involving that particular approach, but cannot be expected to affect left-turn crashes on any other approach.

Countermeasures can also have undesirable effects worth considering in evaluating their overall benefit. For example, the installation of right-turn channelization may reduce crashes involving right-turning vehicles and possibly rear-end crashes on a particular approach, but may increase crashes involving pedestrians. If the countermeasure is to be applied, both positive and negative consequences need to be considered.

The potential crash reduction from a countermeasure is determined by multiplying the expected number of crashes by the percentage reduction that the countermeasure is expected to have. The expected number of crashes (total or by severity) may be assumed to be the same as in the period before the countermeasure, but a much more refined method would be to develop an estimate of the expected number of crashes based on SPF curves or the EB method.

Placing an economic value on crashes by severity is a common practice in quantifying the safety benefits of a countermeasure. There are several ways of arriving at societal cost (such figures are available from FHWA and various State transportation agencies).

Calculating the safety benefit of a countermeasure means multiplying the expected crash reduction by severity (property damage, injury, and fatal) by applicable society cost figures. A means of expressing the calculation of the safety benefit of the countermeasure is as follows:

$$\text{Safety Benefit (\$)} = \Delta n_{PDO} \times C_{PDO} + \Delta n_I \times C_I + \Delta n_F \times C_F \quad (5)$$

- Where:
- Δn_{PDO} = Expected reduction in property-damage-only crashes
 - C_{PDO} = Societal costs of property-damage-only crashes
 - Δn_I = Expected reduction in injury crashes
 - C_I = Societal costs of injury crashes
 - Δn_F = Expected reduction in fatal crashes
 - C_F = Societal costs of fatal crashes.

Collision Type	Societal Crash Costs
Fatal (K)	\$4,008,900
Disabling Injury (A)	\$216,000
Evident Injury (B)	\$79,000
Fatal/Injury (K/A/B)	\$158,200
Possible Injury (C)	\$44,900
PDO (O)	\$7,400

Exhibit 6-18. Societal crash cost estimates by crash severity
Source: Table 7-1 of the Highway Safety Manual

As an example: a multilane signalized intersection has been diagnosed as having a safety problem associated with a particular approach. Adding a right-turn lane is being considered as a possible countermeasure. Calculation of the safety benefit involves determining the product of the yearly average number of crashes, the societal benefit, and the estimated reduction in crashes grouped by crash type (Exhibit 6-19). The total societal benefit is calculated to be \$104,948.

Crash Type	5-Year Total Before Treatment	Yearly Average Before Treatment	Estimated Reduction Due to Treatment	Estimated Yearly Average After Treatment	Unit Societal Benefit	Estimated Yearly Benefit of Treatment
Fatal/ Injury	8	1.6	40%	0.64	\$158,200	\$101,248
PDO	25	5.00	10%	0.50	\$7,4, 00	\$3,700
Total						\$104,948

Exhibit 6-19. Example calculation of safety benefit of adding a right-turn lane.

6.6.2 Step 2 – Estimate Costs of Countermeasures

The next step of economic appraisal is the estimation of implementation costs of projects (countermeasures). Similar to other roadway improvement projects, implementation costs of projects may include right-of-way acquisition, construction cost, utility relocation, environmental impacts, operation costs, maintenance costs, and the cost associated with planning and engineering.

The most important source for the implementation costs of projects is the local past experience of the road agency. The *SafetyAnalyst* software also has costs associated with a number of countermeasures built-in.

6.6.3 Step 3 – Evaluate Cost Effectiveness of Countermeasures

Once benefits and costs of road safety improvement projects are calculated, various methods for benefit-cost analysis practiced in engineering economy can be utilized to evaluate whether the projects are economically viable. In practice, net present worth and benefit-cost ratio are the most commonly used methods.

The benefits and costs estimated before are likely to occur in the future in different time spans. As a result, the present worth of benefits and costs are calculated using an average interest rate (discount rate). Then, the difference between the discounted costs and discounted benefits at the present year (net present worth) is calculated. A project with a net present worth greater than zero indicates a projects with benefits more than costs. These types of projects are economically viable.

In the benefit-cost ratio (BCR) method, first the present worth of benefits and costs are calculated. Then the ratio of present worth of benefits over present worth of costs is calculated. If the ratio is greater than 1.0, the project is economically justified.

The countermeasures which are found economically justified can be implemented to address the safety problems identified in the diagnosis step. However, the main challenge is that resources to implement all countermeasures are not available. As a result, the road agency needs to make a decision to identify which countermeasures should be implemented considering the scarce resources.

6.6.4 Case Study

Exhibit 6-20 summarizes the result of benefit-cost analysis. In this table, the countermeasures proposed in the countermeasure selection step are listed. CMFs associated with each countermeasure have been obtained from the CMF Clearinghouse. The original studies through which the CMFs were developed are cited as footnotes. No CMF was found for two of the countermeasures in Exhibit 6-20. Using the CMFs, crash reduction over a 5-year period was calculated. The crash reduction was converted to benefits using the societal cost of crashes shown in exhibit 6-20. Net present worth of benefits was calculated using a discount rate of 2%. Net present worth of total costs of projects was calculated. A life

cycle of 20 years was assumed for countermeasures. The BCR for countermeasures shows that all proposed countermeasures are economically justified.

The two countermeasures for which no CMF was found are recommended because both are low cost countermeasures and potentially have positive operational impacts.

Countermeasure	CMF	5-Year Total Crash Reduction After Countermeasure	Benefits (\$)	Total Cost (\$)	BCR
Heighten conspicuity of the signal displays for eastbound intersection-approaching road-users	0.85 for all crashes (all severities)	13.5	627,267	6,000	104.5
Address stopping sight distance issues on eastbound approach to the intersection	0.65 for angle crashes (all severities)	3.5	162,625	2,000	81.3
Pavement friction test and potential follow-on construction work	0.76 for all crashes (all severities)	21.6	1,003,627	60,000	16.7
Further enhance the presence of Road B, on approach along Street A	0.984 for all crashes (all severities)	1.44	66,909	2,000	33.5
Install "Intersection Ahead" warning sign	0.65 for all crashes (all severities)	3.5	162,625	2,000	81.3
Install a westbound left-turn lane	0.9 for all crashes (all severities)	9	418,178	280,000	1.5

CMF values developed from a variety of sources, including the Highway Safety Manual and the CMF Clearinghouse

Exhibit 6-20. Summary of benefit-cost analysis.

6.7 PROJECT PRIORITIZATION

In the previous steps of the road safety management process, one or more countermeasures for one or more intersections might be selected. One countermeasure or a combination of countermeasures can be referred to as one project. Now the traffic engineer and the road agency face the important decision of which project should be implemented first and which projects should be implemented at all, considering the limited available resources to maximize benefits to the public (i.e., have most safety improvements).

The following two simple methods can help prioritize projects ⁽⁷¹⁾:

- Ranking by economic effectiveness measures.
- Incremental benefit-cost analysis ranking.

The ranking by economic effectiveness methods is the simplest method for prioritization of projects. In this method, economically justified projects are ranking from high to low by any of the following measures:

- Net present worth.
- Projects costs.
- Monetary value of project benefits.

- Total number of crashes reduced.

Next, the agency may start the projects from the top of the list to the bottom. The main challenge associated with this method is that it ignores resource constraints and potential competing priorities.

In the incremental benefit-cost analysis ranking, the following steps are to be taken ⁽⁷¹⁾:

1. Calculate the BCR for each project.
2. Arrange projects with a BCR greater than 1.0 in increasing order based on their estimated cost. The project with the smallest cost is listed first.
3. Calculate the BCR for the incremental investment by dividing the difference between benefits of the first two ranked projects by the difference between costs of the first two ranked projects.
4. If the BCR for the incremental investment is greater than 1.0, the project with the higher cost is compared to the next project in the list. If the BCR for the incremental investment is less than 1.0, the project with the lower cost is compared to the next project in the list.
5. Repeat this process. The project selected in the last pairing is considered the best economic investment.

To produce a ranking of projects, the entire evaluation is repeated without the projects previously determined to be the best economic investment until the ranking of every project is determined.

6.7.1 Case Study

Exhibit 6-21 shows the priority ranking of countermeasures, which were selected as part of the countermeasure selection step shown in Exhibit 6-20. In this case study, ranking was performed based on the monetary value of project benefits. It should be noted that the road agency has to consider their budget constraints to identify all or some of the projects that can be implemented. Also, if the criteria for ranking changes based on the road agency strategic directions, the priority ranking will change. For example, if the ranking is performed based on total cost of the project, another ranked list is obtained.

Rank	Countermeasure	CMF	5-Year Total Crash Reduction After Countermeasure	Benefits (\$)	Total Cost (\$)	BCR
1	Pavement friction test and potential follow-on construction work	0.76 for all crashes (all severities)	13.5	627,267	6,000	104.5
2	Heighten conspicuity of the signal displays for eastbound intersection-approaching road-users	0.85 for all crashes (all severities)	3.5	162,625	2,000	81.3
3	Install a westbound left-turn lane	0.9 for all crashes (all severities)	21.6	1,003,627	60,000	16.7
4	Address stopping sight distance issues on eastbound approach to the intersection	0.65 for all crashes (all severities)	1.44	66,909	2,000	33.5
5	Install "Intersection Ahead" warning sign	0.65 for all crashes (all severities)	3.5	162,625	2,000	81.3
6	Further enhance the presence of Road B, on approach along Street A	0.984 for all crashes (all severities)	9	418,178	280,000	1.5

Exhibit 6-21. Priority ranking of selected countermeasures.

6.8 SAFETY EFFECTIVENESS EVALUATION

Safety effectiveness evaluation is the process of developing quantitative estimates of how a countermeasure, project, or a group of projects has affected crash frequencies or severities. The effectiveness estimate for a project or treatment is a valuable piece of information for future safety decision making and policy development.

Safety effectiveness evaluation may include:

- Evaluating a single project at a specific site to document the safety effectiveness of that specific project.
- Evaluating a group of similar projects to document the safety effectiveness of those projects.
- Evaluating a group of similar projects for the specific purpose of quantifying a CMF for a countermeasure.
- Assessing the overall safety effectiveness of specific types of projects or countermeasures in comparison to their costs.

Practitioners should conduct a before-after study to evaluate the safety effectiveness of any project. A before-after study compares crash frequencies at a site are before and after implementation of a treatment. The main challenge associated with conducting a before-after study is that a number of factors change at the subject site from the before to after period, in addition to the treatment. These factors may include a change in traffic volume, a change in weather conditions, and other unknown factors. As a result, it is critical to separate the safety changes associated with the treatment from the other factors that have changed from the before period to the after period through a valid before-after study.

In a before-after study, the collision frequencies at the treated sites in the after period are compared with collision frequencies at the same sites had the treatment not been implemented in the after period. Obviously, the collision frequencies had the treatment not been applied are not known. As a result, there are a number of techniques in the literature to predict the collision frequencies in the after period had the treatment not been applied. The following section identifies the commonly used techniques in road safety:

6.8.1 Before-After Study with Comparison Group

In this type of before-after study, a comparison group is selected comprising sites that have similar geometric and operational characteristics as the treatment sites. The number of sites in the comparison group is more than the treatment group. The rationale behind this technique is that all contributing factors that affect safety (i.e., traffic volume, weather, etc.) from the before period to the after period impact both the treatment group and the comparison group in the same way, and the only difference between the treatment sites and comparison sites is the treatment itself. In this method, collision frequency of the treatment group had the treatment not been applied is predicted by multiplying crash frequency of the treatment sites in the after period by the ratio of crash frequency of the comparison sites in the after period to the crash ratio of the comparison sites in the before period.

This method has been widely used in road safety. The only challenge associated with this method is that it does not consider the regression-to-the-mean phenomenon.

6.8.2 Before-After Study with Empirical Bayes

In this technique, instead of using a comparison group, the SPF developed for the reference group associated with the treatment sites is used to predict crash frequency at the treatment sites in the after period had the treatment not been applied. This technique is the preferred technique because it considers the regression-to-the-mean phenomenon.

The HSM provides more details on study design and methods for evaluation of safety effectiveness of countermeasures, and Ezra Hauer provides details on various methods for conducting a valid before-after study in road safety in his seminal book.⁽⁷⁹⁾

CHAPTER 7

OPERATIONAL ANALYSIS METHODS

TABLE OF CONTENTS

7.0	OPERATIONAL ANALYSIS METHODS.....	7-2
7.1	Operational Performance Measures	7-5
7.1.1	Automobile Methodology	7-6
7.1.2	Pedestrian Methodology	7-9
7.1.3	Bicycle Methodology	7-10
7.1.4	Multimodal Approach	7-11
7.2	Traffic Operations Elements	7-11
7.2.1	Traffic Volume Characteristics	7-11
7.2.2	Intersection Geometry.....	7-12
7.2.3	Signal Timing and Hardware Capabilities	7-12
7.3	General Considerations Sizing an Intersection.....	7-13
7.4	Critical Lane Analysis.....	7-14
7.5	HCM Operational Procedure for Signalized Intersections	7-17
7.6	Arterial and Network Signal Timing Models	7-18
7.6.1	Introduction	7-18
7.6.2	Developing a Macroscopic Simulation Model	7-18
7.7	Microscopic Simulation Models.....	7-19
7.7.1	Introduction	7-19
7.7.2	Developing a Microsimulation Model	7-19
7.8	Operational Performance Model Selection	7-20

LIST OF EXHIBITS

7-1	Still reproduction of a graphic from an animated traffic operations model	7-3
7-2	Overview of intersection traffic analysis models	7-4
7-3	Typical lane groups for analysis	7-6
7-4	Automobile LOS thresholds at signalized intersections.....	7-8
7-5	Effect of flow rate and detection design on max-out probability	7-9
7-6	Evaluation of circulation area based on pedestrian space	7-9
7-7	LOS criteria for pedestrian and bicycle modes	7-10
7-8	Planning-level guidelines for sizing an intersection	7-14
7-9	Graphical summary of the quick estimation method.....	7-15
7-10	V/C ratio threshold descriptions for the quick estimation method	7-16
7-11	Criteria for selecting a traffic analysis tool category	7-21

7.0 OPERATIONAL ANALYSIS METHODS

Chapter 6 described tools that can be used to assess safety performance at a signalized intersection. Evaluating a candidate treatment also usually requires assessing its performance from the perspective of traffic operations. This chapter will focus on measures for assessing operational performance and computational procedures used to determine specific values for those measures.

The relationships between safety performance and operational performance are difficult to define in general terms. Some intersection treatments that would improve safety might also improve operational performance, but others might diminish operational performance. Furthermore, the nature of safety and operational measures makes them difficult to combine in a way that would represent both perspectives.

Operational performance measures tend to be fewer in number and more easily related to site-specific conditions than are safety performance measures. The computations themselves are more amenable to deterministic models, and a wide variety of such models, mostly software-based, are available. Selection of a model for a specific purpose is generally based on the tradeoff between the difficulty of applying the model and the required degree of accuracy and confidence in the results. The degree of application difficulty is reflected in the required amount of site-specific data as well as the level of personnel time and training needed to apply the model and to interpret the results.

Recent user interface enhancements in the more advanced traffic model software products have made the products much easier to apply. Most can generate animated graphics displays depicting the movement of individual vehicles and pedestrians in an intersection (see Exhibit 7-1) and some allow for three-dimensional rendering. These enhancements have caused an increasing trend toward the use and acceptance of advanced traffic modeling techniques.

While the range of operational performance models is more or less continuous, it will be categorized into the following analysis levels for purposes of this discussion:

- Rules of thumb for intersection sizing.
- Critical lane analysis.
- The *HCM 2010* operational analysis procedure.⁽²⁾
- Arterial signal timing design and evaluation models.
- Microscopic simulation models.

These levels are listed in order of complexity and application difficulty, from least to greatest. Each analysis level will be discussed separately.

The process for evaluating the operational performance of an intersection remains unchanged regardless of the analysis level and the issues at hand. The analysis should begin at the highest level and should continue to the next level of detail until the key operations-related issues and concerns have been addressed in sufficient detail. Additional guidance for each level above can be found in the FHWA Traffic Analysis Tools Program website at <http://ops.fhwa.dot.gov/trafficanalysisistools/>.

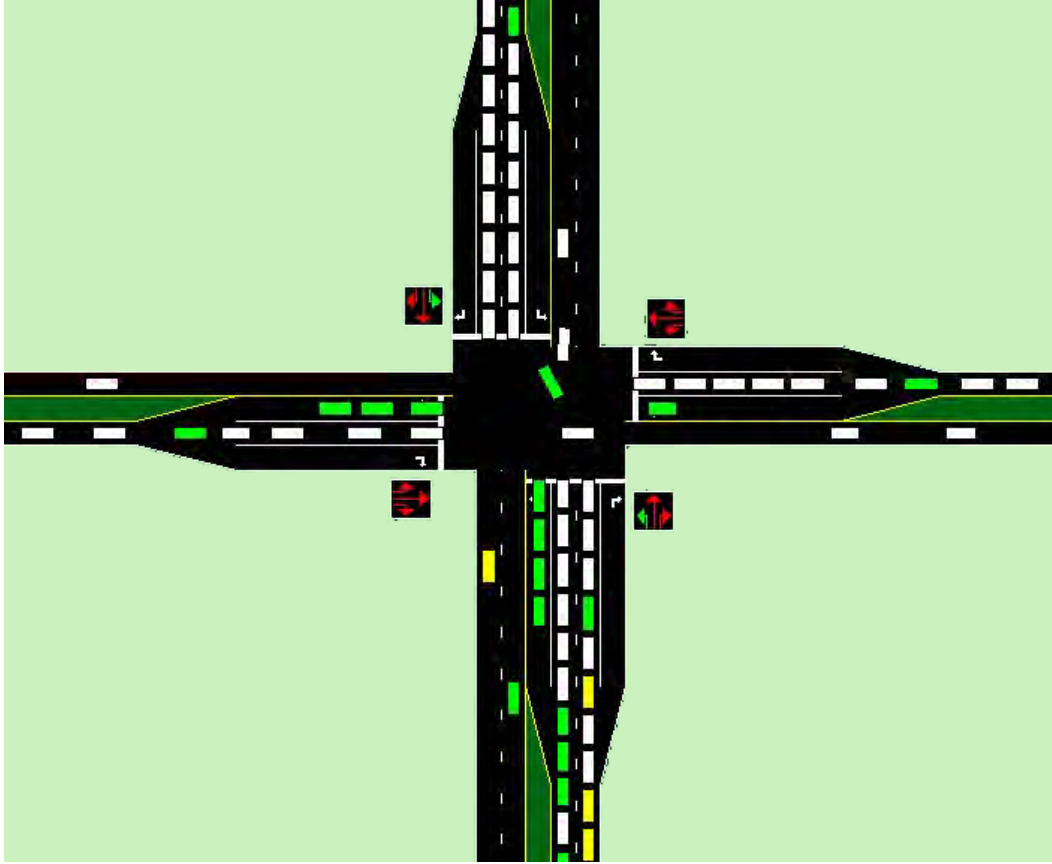

Exhibit 7-1. Still reproduction of a graphic from an animated traffic operations model.

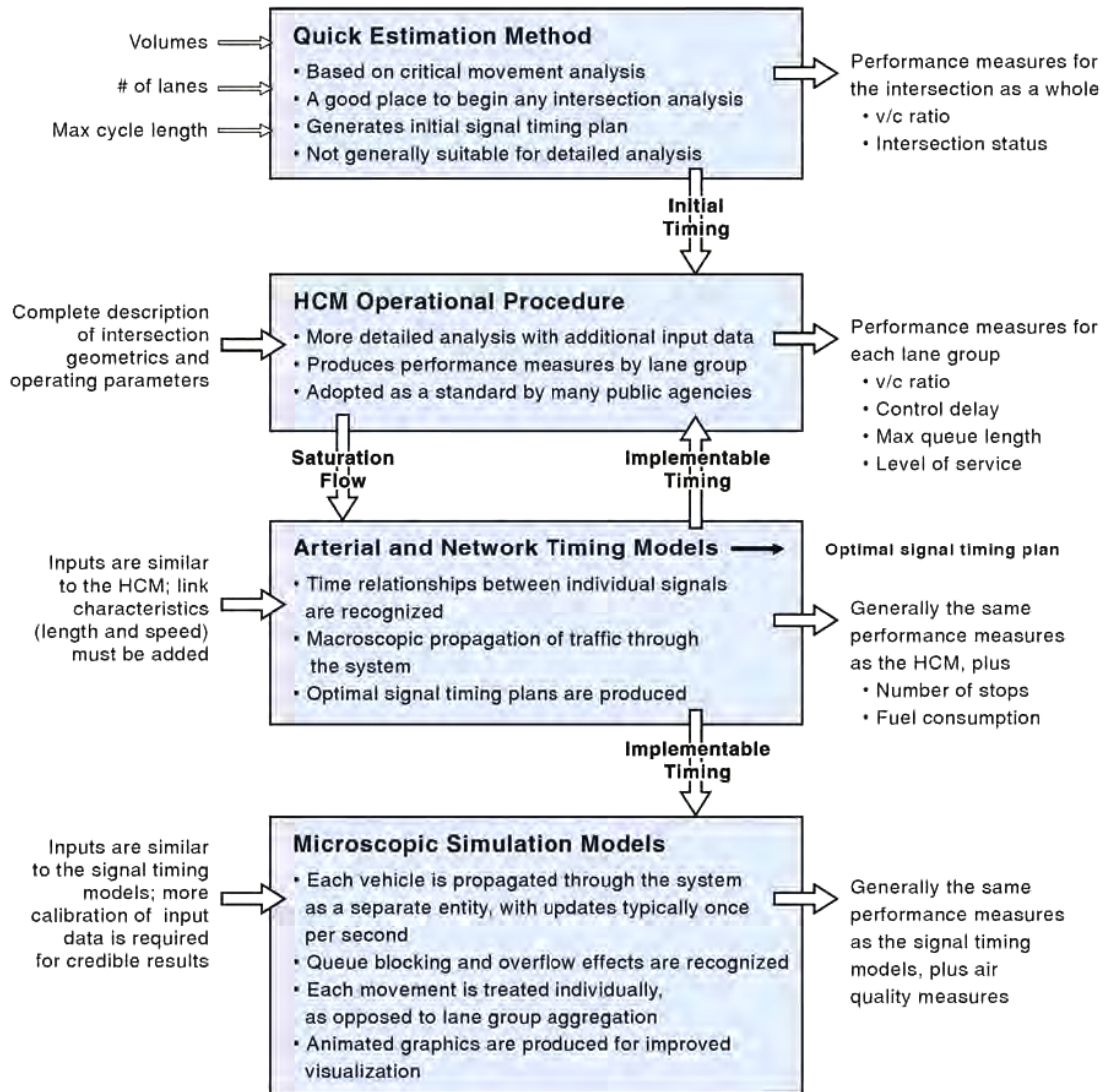

Exhibit 7-2. Overview of intersection traffic analysis models.

The ability to measure, evaluate, and forecast traffic operations is a fundamental element of effectively diagnosing problems and selecting appropriate treatments for signalized intersections. A traffic operations analysis should describe how well an intersection accommodates demand for all user groups. Traffic operations analysis can be used at a high level to size a facility and at a refined level to develop signal timing plans. This section describes key elements of signalized intersection operations and provides guidance for evaluating results.

In all analysis methods, especially those that involve modeling, it is important that any tools used are calibrated and validated for real-life field conditions to ensure credible analysis results. Data collected include entering traffic volume, turning movements, queue lengths, vehicle speed, and lane capacity. Modifications to the software tools may be necessary to accurately reflect field conditions. It is necessary to document all calibration adjustments to support credibility.

7.1 OPERATIONAL PERFORMANCE MEASURES

A signalized intersection's performance is described by the use of one or more quantitative measures that characterize some aspects of the service provided to specific road user groups. The *HCM 2010* introduces four road user groups: automobile, pedestrian, bicycle, and transit. In order to encourage users to consider all travelers on a facility when they perform analyses and make decisions, the *HCM 2010* integrates material on automobile and non-automobile modes.

Generally, three methodologies are used to evaluate the performance measures of signalized intersection operations. They are referred to as the automobile methodology, the pedestrian methodology, and the bicycle methodology. Each methodology addresses one possible travel mode through the intersection. A complete evaluation of intersection operation includes the separate examination of performance for all relevant travel modes. The performance measures associated with each travel mode are as follows:

- a) Automobile mode
 - Capacity and volume-to-capacity ratio.
 - Delay and Level of Service (LOS).
 - The back-of-queue and queue storage ratio.
 - Probability of phase termination by max out or force-off.
- b) Pedestrian mode
 - Corner and crosswalk circulation area.
 - Pedestrian delay.
 - Pedestrian LOS score.
- c) Bicycle mode
 - Bicycle delay.
 - Bicycle LOS score.

The *HCM 2010* evaluates the intersection operation by the concept of movement groups and lane groups.⁽²⁾ A separate movement group is established for (a) each turn movement with one or more exclusive turn lanes with no shared movements, and (b) the through movement inclusive of any turn movements that share a lane.

The movement group and lane group designations are very similar in meaning. In fact, their differences emerge only when a shared lane (such as a through lane that is also serving right turns) is present on an approach with two or more lanes.⁽²⁾ Thus, any shared lane is considered as a separate lane group, while an exclusive turn lane or lanes should be designated as another separate lane group. Similar to movement group definition, any lanes that are not exclusive turn lanes or shared lanes are combined into one lane group. These rules for movement group and lane group result in designation of different group possibilities for an intersection approach. Exhibit 7-3 presents some common movement groups and lane groups.⁽²⁾

Number of Lanes	Movements by Lanes	Movement Groups (MG)	Lane Groups (LG)
1	Left, thru., & right:	MG 1:	LG 1:
2	Exclusive left: Thru. & right:	MG 1: MG 2:	LG 1: LG 2:
2	Left & thru.: Thru. & right:	MG 1:	LG 1: LG 2:
3	Exclusive left: Exclusive left: Through: Through: Thru. & right:	MG 1: MG 2:	LG 1: LG 2: LG 3:

Exhibit 7-3. Typical lane groups for analysis.⁽²⁾

7.1.1 Automobile Methodology

The automobile methodology described in the *HCM 2010* is originally based on the results of NCHRP Project 3-28(2) study that formulated (a) the critical movement analysis procedure developed in the United States, Australia, Great Britain, and Sweden, and (b) the automobile delay estimation procedure, developed in Great Britain, Australia, and the United States. The updated procedures described in the *HCM 2010* are used to evaluate the associated automobile performance measures for signalized intersection.

7.1.1.1 Capacity and volume-to-capacity ratio

Capacity is defined as the maximum sustainable flow rate at which vehicles can pass through a given point in an hour under prevailing conditions; it is often estimated based on assumed values for saturation flow, and width of lanes, grades, and lane use allocations, as well as signalization conditions. Under the *HCM 2010* procedure, intersection capacity is measured for critical lane groups (those lane groups that have the highest volume-to-capacity ratios). Critical intersection volume-to-capacity ratios are based on flow ratio for the critical phase. A critical phase is one phase of a set of phases that occur in sequence and whose combined flow ratio is the largest for the signal cycle. Rules for determining critical flow ratio and critical path are further explained in *HCM 2010*.

Research conducted as part of the 1985 HCM showed that the capacity for the critical lanes at a signalized intersection was approximately 1,400 vehicles per hour.⁽⁸⁰⁾ This capacity is a planning-level estimate that incorporates the effects of loss time and typical saturation flow rates. Studies conducted in the State of Maryland have shown that signalized intersections in urbanized areas have critical lane volumes upwards of 1,800 vehicles per hour.⁽⁸¹⁾

The volume-to-capacity (v/c) ratio, also referred to as degree of saturation, represents the sufficiency of an intersection to accommodate the vehicular demand. A v/c ratio less than 0.85 generally indicates that adequate capacity is available and vehicles are not expected to experience significant queues and delays. As the v/c ratio approaches 1.0, traffic flow may become unstable, and delay and queuing conditions may occur. Once the demand exceeds the

capacity (a v/c ratio greater than 1.0), traffic flow is unstable and excessive delay and queuing is expected. Aside from the excessive demand, there are other factors that may contribute to cycle failure as well (e.g., influence of pedestrians, poor signal timing, incidents, etc.). Under these conditions, vehicles may require more than one signal cycle to pass through the intersection (known as a cycle failure). For design purposes, a v/c ratio between 0.85 and 0.95 generally is used for the peak hour of the horizon year (generally 20 years out). Over-designing an intersection should be avoided due to negative impacts to all users associated with wider street crossings, the potential for speeding, land use impacts, and cost.

Delay

Delay is defined in the *HCM 2010* as “the additional travel time experienced by a driver, passenger, bicyclist, or pedestrian beyond that is required to travel at the desired speed.”⁽²⁾ The signalized intersection chapter (Chapter 18) of the *HCM 2010* provides equations for calculating control delay, the delay a motorist experiences that is attributable to the presence of the traffic signal and conflicting traffic. This includes time spent decelerating, in the queue, and accelerating. Expectation of delay at a signalized intersection is different than at an unsignalized intersection.

The control delay equation comprises three elements: uniform delay, incremental delay, and initial queue delay. The primary factors that affect uniform delay are lane group volume, lane group capacity, cycle length, and effective green time. Two factors that account for incremental delay are (a) the effect of random and cycle-by-cycle fluctuations in demand that occasionally exceed capacity, and (b) a sustained oversaturation during the analysis period, when the aggregate demand exceeds the aggregate capacity. The third component of the control delay illustrates the delay due to an initial queue, as a result of unmet demand in the previous time period.

The Back-of-queue and Queue Storage Ratio

Practitioners should evaluate vehicle queuing, an important performance measure, as part of all signalized intersections analyses. Vehicle queue estimates help determine the amount of storage required for turn lanes and whether spillover occurs at upstream facilities (driveways, unsignalized intersections, signalized intersections, etc.). Queues that extend upstream from an intersection can spill back into and block upstream intersections, causing side streets to begin to queue back. The back-of-queue is the maximum backward extent of queued vehicles during a typical cycle. This back-of-queue length depends on the arrival pattern of vehicles and the number of vehicles that do not clear the intersection during the previous cycle.⁽²⁾ Approaches that experience extensive queues also may experience an over-representation of rear-end collisions. Vehicle queues for design purposes are typically estimated based on the 95th percentile queue that is expected during the design period. This is the length at which 95 percent of lane queues are less than in a given study period.

The queue storage ratio represents the proportion of the available queue storage distance that is occupied at the point in the cycle when the back-of-queue position is reached.⁽²⁾ If this ratio exceeds 1.0, then the storage space will overflow and queued vehicles may block other vehicles from moving forward.

Volume 3 of the *HCM 2010* provides procedures for calculating back-of-queue length and the queue storage ratio. In addition, all known simulation models provide ways of obtaining queue estimates.

Level of Service (LOS)

Level of Service (LOS) is a grading-scale based descriptor that attempts to relate relative operational quality (based on certain measures of effectiveness) to that of driver perception in a simple fashion. Control delay is used as the basis for determining LOS for an intersection or a single approach. Delay thresholds for the various LOS are given in Exhibit 7-4.

Typically LOS is reported on an A through F scale, with Level A being the best LOS and Level F being the worst. While the A through F scale seems fairly straightforward, the quantifiable measures of effectiveness (MOEs) used to derive the “grading scale” are derived from empirical data.

For signalized intersections, control delay (in seconds) is the MOE for the LOS scale (note that the grade thresholds for signalized intersections are different than for stop-controlled intersections). However, there are other MOEs that are important in characterizing the operations of signalized intersections, including v/c ratio and intersection utilization. Furthermore, while it is common for weighted averages to be used in describing overall intersection operation, it is often the case where one or more specific movements, lane groups, or approaches may be operating poorly, but be masked by the overall average. Also, when intersections are operating at capacity (i.e., LOS F) and beyond, only close analysis of the various MOEs will allow for distinctions to be made among different alternatives. Finally, it should be noted that safety is not reflected or implied in LOS.

Exhibit 7-4. Automobile LOS thresholds at signalized intersections.⁽²⁾

Control Delay per Vehicle (seconds per vehicle)	LOS by V/C Ratio	
	≤1	>1
≤ 10	A	F
> 10-20	B	F
> 20-35	C	F
> 35-55	D	F
> 55-80	E	F
> 80	F	F

LOS has historically been given high emphasis by practitioners due to its relative ease of explanation, but it is a crude measure at best. The language of LOS (A-F scale) is easily understood, regardless of the background MOEs used or their accuracy in actually determining the operation of the intersection.

Probability of Phase Termination by Max-out or Force-off

For actuated and semi-actuated operation, the maximum green time is the maximum limit to which the green time can be extended for a phase in the presence of a call from a conflicting phase. The maximum green time begins when a call is placed on a conflicting phase. The phase is allowed to “max-out” if the maximum green time is reached even if actuations have been received that would typically extend the phase. However, the safety benefit of green extension can be negated if the phase is extended to its maximum duration (i.e., maximum-green setting). The probability of termination by “max-out” is dependent on flow rate in the subject phase and the “maximum allowable headway.” Exhibit 7-5 illustrates the relationship between max-out probability, maximum allowable headway, maximum green, and flow rate for actuated and semi-actuated operation. For coordinated operation, the main street phase will receive its entire split time (effectively a force-off) regardless of calls on conflicting phases.

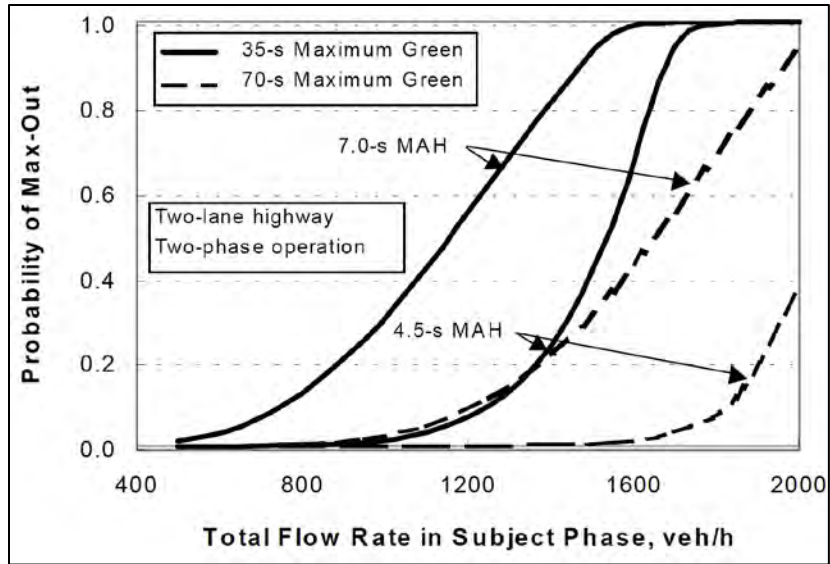

Exhibit 7-5. Effect of flow rate and detection design on max-out probability.
 Source: Bonneson, J. et al, *Intelligent Detection-Control System for Rural Signalized Intersections*, FHWA/TX-03/4022-2, 2002.

7.1.2 Pedestrian Methodology

This section describes the methodology for evaluating the performance of a signalized intersection in terms of its service to pedestrians.

Corner and Crosswalk Circulation Area

The corner and crosswalk circulation area are used to evaluate the circulation area provided to pedestrians while they are waiting at the corner or crossing the crosswalk, respectively. Exhibit 7-6 can be used to evaluate intersection performance from a circulation-area prospective in terms of space available to the average pedestrian.⁽²⁾

Exhibit 7-6. Evaluation of circulation area based on pedestrian space.⁽²⁾

Pedestrian Space (ft ² per pedestrian)	Description
>60	Ability to move in desired path, no need to alter movements
> 40-60	Occasional need to adjust path to avoid conflicts
> 24-40	Frequent need to adjust path to avoid conflicts
> 15-24	Speed and ability to pass slower pedestrian restricted
> 8-15	Speed restricted, very limited ability to pass slower pedestrian
≤ 8	Speed severely restricted, frequent contact with other users

The critical parameter for the analysis of circulation area at the street corner and crosswalk is the product of available time and space with pedestrian demand, which combines the physical design constrains (i.e., available space) and signal operation (i.e., available time). This parameter is referred to as the “time-space” available for pedestrian circulation.⁽²⁾ Circulation time-space and pedestrian circulation area are estimated based on intersection and pedestrian signal phasing settings, pedestrian flow rates in different directions, and physical characteristics of the sidewalks. Chapter 18 of the *HCM 2010* provides the detailed procedure for calculating street corner and crosswalk circulation area.

Pedestrian Delay

In the *HCM 2010* (Chapter 18), pedestrian delay at a signalized intersection while crossing the major street is determined based on effective walk time and cycle length. The delay computed in this step can be used to make judgments about pedestrian compliance. Research indicates that pedestrians become impatient when they experienced delay in excess of 30 seconds per pedestrian. In contrast, it is reported that pedestrians are very likely to comply with signal indicators if their expected delay is less than 10 seconds per pedestrian.⁽²⁾

Pedestrian LOS Score

Historically, the HCM has used a single performance measure as the basis for defining LOS. However, in the *HCM 2010*, the LOS is separated for automobile and non-automobile modes. Based on traveler perception research for pedestrians and bicyclists, it was found that a wide variety of factors should be considered in assessing the quality of service for non-automobile road users. Therefore, a methodology for evaluating each mode was developed to mathematically combine various factors into a score. Exhibit 7-7 presents the range of scores associated with each LOS for pedestrian and bicycle travel modes.

Exhibit 7-7. LOS criteria for pedestrian and bicycle modes.⁽²⁾

LOS Score	LOS
≤ 2.00	A
> 2.00 – 2.75	B
> 2.75 – 3.50	C
> 3.50 – 4.25	D
> 4.25 – 5.00	E
> 5.00	F

The pedestrian LOS score for the intersection is calculated based on a number of factors, such as traffic counts during a 15-min period, 85th percentile speed on the major street, pedestrian delay when traversing, and number of right-turn channelizing islands along crosswalk. The detailed calculations of pedestrian LOS score are presented in the *HCM 2010* (Chapter 18). Finally, the pedestrian LOS is determined from Exhibit 7-7 by using the calculated pedestrian LOS score. As discussed above, LOS is a crude measure of pedestrian operational efficiency and is often overused by designers.

7.1.3 Bicycle Methodology

This section describes the methodology for evaluating the performance of a signalized intersection in terms of its service to bicyclists. This section replicates the procedure from Chapter 18 of the *HCM 2010*.

Bicycle Delay

The *HCM 2010* provides an analysis procedure for assessing the delay for bicycles at signalized intersections where there is a designated on-street bicycle lane on at least one approach or a shoulder that can be used by bicyclists as a bicycle lane.

Many countries have reported a wide range of capacities and saturation flow rates for bicycle lanes at signalized intersections. The *HCM 2010* recommends the use of a saturation flow rate of 2,000 bicycles per hour as an average value achievable at most intersections. This rate assumes that right-turning motor vehicles yield the right-of-way to through bicyclists. Where aggressive right-turning traffic exists, this rate may not be achievable and local observations are recommended to determine an appropriate saturation flow rate.

Using the default saturation flow rate of 2,000 bicycles per hour, the capacity of the bicycle lane and control delay at a signalized intersection can be computed, based on effective green time for the bicycle lane, and cycle length.

At most signalized intersections, the only delay to bicycles is caused by the signal itself because bicycles have right-of-way over turning motor vehicles. Where bicycles are forced to weave with motor vehicle traffic or where bicycle right-of-way is disrupted due to turning traffic, additional delay may be incurred. Bicyclists tend to have about the same tolerance for delay as pedestrians.

Bicycle LOS Score

Following the same methodology as pedestrian mode, bicycle LOS score is first calculated based on physical characteristics of the intersection, traffic flow rate, and the proportion of on-street occupied parking. The detailed calculations of bicycle LOS score are presented in the *HCM 2010* (Chapter 18). Finally, the bicycle LOS is determined from Exhibit 7-7 by using the calculated bicycle LOS score. As discussed above, LOS is a crude measure of pedestrian operational efficiency and is often overused by designers.

7.1.4 Multimodal Approach

In the *HCM 2010*, there are no stand-alone analyses for pedestrians, bicyclists, and transit users. Instead, the HCM encourages performing multimodal analysis of non-automobile modes on a specific facility of urban streets, such as a signalized intersection, in addition to automobile analysis. The *Transit Capacity and Quality of Service Manual (TCQSM)*, recognized as the companion of *HCM 2010*, extensively covers the analysis of the transit mode. Therefore, the *HCM 2010* now addresses the transit mode only with respect to multimodal analysis of urban streets.⁽²⁾

7.2 TRAFFIC OPERATIONS ELEMENTS

The following sections will describe signalized intersection operations as a function of the following three elements and discuss their effects on operations.

1. Traffic volume characteristics.
2. Roadway geometry.
3. Signal timing and hardware capabilities.

7.2.1 Traffic Volume Characteristics

The traffic characteristics used in an analysis can play a critical role in determining intersection treatments. Over-conservative judgment may result in economic inefficiencies due to the construction of unnecessary treatments or an oversized intersection, while the failure to account for certain conditions (such as a peak recreational season) may result in facilities that are inadequate and experience failing conditions during certain periods of the year.

An important element of developing an appropriate traffic profile is distinguishing between traffic demand and traffic volume. For an intersection, traffic demand represents the arrival pattern of vehicles, while traffic volume is generally measured as the number of vehicles that pass through the intersection over a specific period of time. In the case of overcapacity or constrained situations, the traffic volume typically does not reflect the true demand on an intersection because vehicles are queued upstream. In these cases, the user should develop a demand profile by measuring vehicle arrivals upstream of the overcapacity or constrained approach. The difference between arrivals and departures represents the vehicle demand that does not get served by the traffic signal. This volume should be accounted for in the traffic operations analysis.

Traffic volume at an intersection may also be less than the traffic demand due to an overcapacity condition at an upstream or downstream signal. If the constraint is upstream, traffic

volumes would be metered at that location and “starve” the demand at the subject intersection; if the constraint is downstream, traffic could spill back to the subject intersection and impede traffic flow. These effects are often best accounted for using a microsimulation analysis tool.

7.2.2 Intersection Geometry

The geometric features of an intersection influence the service volume or amount of traffic an intersection can process. A key measure used to establish the supply of an intersection is saturation flow, which is similar to capacity in that it represents the number of vehicles that traverse a point per hour. However, saturation flow is reported assuming the traffic signal is green the entire hour. By knowing the saturation flow and signal timing for an intersection, one can calculate the capacity (capacity = saturation flow times the ratio of green time to cycle length). Saturation headway is determined by measuring the average time headway between vehicles that discharge from a standing queue at the start of green, beginning with the fourth vehicle.⁽²⁾ Saturation headway is expressed in time (seconds) per vehicle.

Saturation flow rate is simply determined by dividing the average saturation headway into the number of seconds in an hour (3,600) to yield units of vehicles per hour. The *HCM 2010* uses a default ideal saturation flow rate of 1,900 vehicles per hour. Ideal saturation flow assumes the following:

- 12-ft wide travel lanes.
- Through movements only.
- Even lane utilization,
- Level grades.
- No curbside impedances
- No pedestrians/bicyclists.
- No central business district influences.

The *HCM 2010* provides adjustment factors for non-ideal conditions to estimate the prevailing saturation flow rate. Saturation flow rate can vary in time and location and has been observed to range between 1,500 and 2,000 passenger cars per hour per lane.⁽²⁾ Given the variation that exists in saturation flow rates, local data should be collected where possible to improve the accuracy of the analysis.

Practitioners should evaluate existing or planned intersection geometry to determine features that may impact operations and that require special consideration.

7.2.3 Signal Timing and Hardware Capabilities

The signal timing of an intersection also plays an important role in its operational performance. Key factors include:

- **Effective green time.** Effective green time represents the amount of usable time available to serve vehicular movements during a phase of a cycle. It is equal to the displayed green time minus startup lost time. The effective green time for each phase is generally determined based on the proportion of volume in the critical lane for that phase relative to the total critical volume of the intersection. If not enough green time is provided, vehicle queues will not be able to clear the intersection, and cycle failures will occur. If too much green time is provided, portions of the cycle will be unused, resulting in inefficient operations and frustration for drivers on the adjacent approaches.

- **Change and clearance interval.** The change and clearance interval represents the amount of time needed for vehicles to safely clear the intersection. It includes the yellow change and red clearance intervals and is primarily set based on the speed of approaching vehicles and the width of the intersection. The effect of the change and clearance interval on capacity is dependent upon the lost time.
- **Lost time.** Lost time represents the unused portion of a vehicle phase. Lost time occurs twice during a phase: at the beginning when vehicles are accelerating from a stopped position, and at the end when vehicles decelerate in anticipation of the red indication. Longer lost times reduce the amount of effective green time available and thus reduce the capacity of the intersection. Wide intersections and intersections with skewed approaches or unusual geometrics typically experience greater lost times than conventional intersections.
- **Cycle length.** Cycle length determines how frequently during the hour each movement is served. It is a direct input, in the case of pre-timed or coordinated signal systems running on a common cycle length, or an output of vehicle actuations, minimum and maximum green settings, and clearance intervals. Cycle lengths that are too short do not provide adequate green time for all phases and result in cycle failures. Longer cycle lengths can result in increased delay and queues for all users, and may result in disobedience of the traffic signal and other aggressive driving behavior.
- **Phasing.** The phasing plan is based on the treatment of each left turn (protected, permitted, or protected-permitted). The number of phases at a signalized intersection, which is directly correlated with its treatment of left turns, impacts the operating capacity of the intersection as it affects effective green time for each movement.
- **Signal Technology.** Technology can play a significant role in the operating capacity of a signalized intersection. A pre-timed signal, which provides a fixed amount of green time to each intersection approach independent of actual traffic demand, is the simplest form of operation. Actuated signals rely on vehicle detection technology and generally operate more efficiently by extending signal phases when continuous demand is present and skipping phases that would not be servicing any vehicles. The most advanced signal technology, called adaptive signal control, uses sensors to read current traffic conditions and modify signal timings based on real-time information.
- **Progression.** Progression is the movement of vehicle platoons from one signalized intersection to the next. A well-progressed or well-coordinated system moves platoons of vehicles so that they arrive during the green phase of the downstream intersection. When this occurs, fewer vehicles arrive on red, and vehicle delays, queues, and stops are minimized. A poorly coordinated system moves platoons such that vehicles arrive on red, which increases the delay and queues for those movements beyond what would be experienced if random arrivals occurred.
- **Detector Technology.** Use of detector features and settings can impact operations positively or negatively. Employing features such as delay, lock, or switch can improve service to waiting or approaching vehicles and streamline intersection operations. Factors such as volumes, phasing, geometry, and driver characteristics (aggressive or passive) will help influence if and how detector settings are used, and how the controller receives those inputs.

7.3 GENERAL CONSIDERATIONS FOR SIZING AN INTERSECTION

This first level of analysis does not use formal models or procedures; instead, it relies on past experience and rules of thumb to offer a very coarse approximation. In spite of its obvious limitations, this approach can be used to size an intersection and determine appropriate lane configurations. Guidelines for determining intersection geometry at the planning level are shown in Exhibit 7-8.

Exhibit 7-8. Planning-level guidelines for sizing an intersection.

Geometric Property	Comment
Number of lanes⁽²⁾	As a general suggestion, enough roadway lanes should be provided to prevent a lane from exceeding 450 vehicles per hour. Mainline facilities that are allocated the majority of green time may accommodate higher volumes. Other elements that should be considered in the sizing of a facility include the number of upstream/downstream lanes, lane balance, signal design elements, pedestrian/bicycle effects, right-of-way constraints, and safety implications.
Exclusive left-turn lanes⁽²⁾	The decision to provide an exclusive left-turn lane should generally be based on the volume of left-turning and opposing traffic, intersection design, and safety implications. Exclusive left-turn lanes should be investigated when a left-turn volume exceeds 100 vehicles per hour. Dual left-turn lanes could be considered when the left-turn volume exceeds 300 vehicles per hour. On some facilities, left-turn lanes may be desirable at all locations regardless of volume.
Exclusive right-turn lanes⁽²⁾	The provision of right-turn lanes reduces impedances between lower speed right-turning vehicles and higher speed left-turning or through vehicles. Separating right turns also reduces the green time required for a through lane. Safety implications associated with pedestrians and bicyclists should be considered. In general, a right-turn lane at a signalized intersection should be considered when the right-turn volume and adjacent through lane volume each exceeds 300 vehicles per hour.
Left-turn storage bay length⁽³⁾	Storage bays should accommodate one and one-half to two times the average number of left-turn arrivals during a cycle.

7.4 CRITICAL LANE ANALYSIS

Critical lane analysis (CLA) is usually applied at the planning stage and represents the highest of the four levels of operational performance models.

The Quick Estimation Method (QEM) can be carried out by hand, although software implementation is much more productive. The computations themselves are somewhat complex, but the minimal requirement for site-specific field data (traffic volumes and number of lanes) allows the QEM to remain a simple procedure. While the level of output detail is simplified in comparison to more data-intensive analysis procedures, the QEM provides a useful description of the operational performance by answering the following questions:

- What are the critical movements at the intersection?
- Is the intersection operating below, near, at, or above capacity?
- Where are the capacity improvements needed?

The requirement for site-specific data is minimized through the use of assumed values for most of the operating parameters and by a set of steps that synthesizes a “reasonable and effective” operating plan for the signal. Exhibit 7-9 illustrates the various steps involved in conducting a QEM analysis, and Exhibit 7-10 identifies the various thresholds for the v/c ratio.

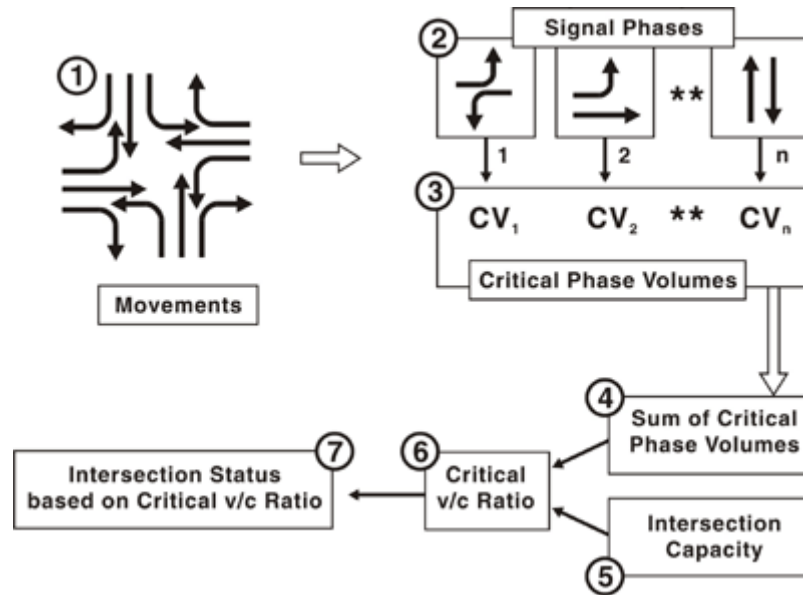

Exhibit 7-9. Graphical summary of the quick estimation method.

Step 1 – Identify movements to be served and assign hourly traffic volumes per lane. This is the only site-specific data that must be provided. The hourly traffic volumes are usually adjusted to represent the peak 15-minute period. The number of lanes must be known to compute the hourly volumes per lane.

Step 2 – Arrange the movements into the desired signal phasing plan. The phasing plan is based on the treatment of each left turn (protected, permitted, etc.). The actual left-turn treatment may be used, if known. Otherwise, the likelihood of needing left-turn protection on each approach will be established from the left-turn volume and the opposing through traffic volume.

Step 3 – Determine the critical volume per lane that must be accommodated on each phase. Each phase typically accommodates two non-conflicting movements. This step determines which movements are critical. The critical lane volume determines the amount of time that must be assigned to the phase on each signal cycle.

Step 4 – Sum the critical phase volumes to determine the overall critical volume that must be accommodated by the intersection. This is a simple mathematical step that produces an estimate of how much traffic the intersection needs to accommodate.

Step 5 – Determine the maximum critical volume that the intersection can accommodate. This represents the overall intersection capacity.

Step 6 – Determine the critical v/c ratio, which is computed by dividing the overall critical volume by the overall intersection capacity, after adjusting the intersection capacity to account for time lost due to starting and stopping traffic on each cycle. The lost time will be a function of the cycle length and the number of protected left turns.

Step 7 – Determine the intersection status from the critical volume-to-capacity ratio. The status thresholds are given in Exhibit 7-10.

Exhibit 7-10. V/C ratio threshold descriptions for the quick estimation method.⁽²⁾

Critical Volume-to-Capacity Ratio	Assessment
< 0.85	Intersection is operating under capacity. Excessive delays are not experienced.
0.85-0.95	Intersection is operating near its capacity. Higher delays may be expected, but continuously increasing queues should not occur.
0.95-1.0	Unstable flow results in a wide range of delay. Intersection improvements will be required soon to avoid excessive delays.
> 1.0	The demand exceeds the available capacity of the intersection. Excessive delays and queuing are anticipated.

Understanding the critical movements and critical volumes of a signalized intersection is a fundamental element of any capacity analysis. A CLA should be performed for all intersections considered for capacity improvement. The usefulness and effectiveness of this step should not be overlooked, even for cases where more detailed levels of analysis are required. The CLA procedure gives a quick assessment of the overall sufficiency of an intersection. For this reason, it is useful as a screening tool for quickly evaluating the feasibility of a capacity improvement and discarding those that are clearly not viable.

Some limitations of CLA procedures in general, and the QEM in particular:

- No provision exists for the situation in which the timing requirements for a concurrent pedestrian phase (such as for crossing a wide street) exceed the timing requirements for the parallel vehicular phase. As a result, the CLA procedure may underestimate the green time requirements for a particular phase.
- A fixed value is assumed for the overall intersection capacity per lane. Adjustment factors are not provided to account for differing conditions among various sites, and there is no provision for the use of field data to override the fixed assumption.
- Complex phasing schemes such as lagging left-turn phases, right-turn overlap with a left-turn movement, exclusive pedestrian phases, leading/lagging pedestrian intervals, etc., are not considered. Significant operational and/or safety benefits can sometimes be achieved by the use of complex phasing.
- Lost time is not directly accounted for in the CLA procedures. Therefore, the effect of longer change and clearance intervals cannot be directly accommodated with this procedure.
- The synthesized operating plan for the signal does not take minimum green times into account, and therefore may not be readily implemented as a part of an intersection design. The HCM specifically warns against the use of the QEM for signal timing design.
- Performance measures (e.g., control delay, LOS, and back of queue) are not provided.

For these reasons, it will be often necessary to examine the intersection using a more detailed level of operational performance modeling.

7.5 HCM OPERATIONAL PROCEDURE FOR SIGNALIZED INTERSECTIONS

For many applications, performance measures such as vehicle delay, LOS, and queues are desired. These measures are not reported by the CLA procedures, but are provided by macroscopic-level procedures such as the HCM operational analysis methodology for signalized intersections. This procedure is represented as the second analysis level in Exhibit 7-2. Macroscopic-level analyses provide results over multiple cycle lengths based on hourly vehicle demand and service rates. HCM analyses are commonly performed for 15-minute periods to accommodate the heaviest part of the peak hour.

The HCM analysis procedures provide estimates of saturation flow, capacity, delay, LOS, and back of queue by lane group for each approach. Exclusive turn lanes are considered as separate lane groups. Lanes with shared movements are considered a single lane group. Lane group results can be aggregated to estimate average control delay per vehicle at the intersection level.

The increased output detail compared to the CLA procedure is obtained at the expense of additional input data requirements. A complete description of intersection geometrics and operating parameters must be provided. Several factors that influence the saturation flow rates (e.g., lane width, grade, parking, pedestrians) must be specified. A complete signal operating plan, including phasing, cycle length, and green times, must be developed externally. As indicated in Exhibit 7-2, an initial signal operating plan may be obtained from the QEM, or a more detailed and implementable plan may be established using a signal timing model that represents the next level of analysis. Existing signal timing may also be obtained from the field.

In addition to the signalized intersection procedure, the HCM also includes procedures to estimate the LOS for bicyclists, pedestrians, and transit users at signalized intersections. These have been discussed previously in this chapter.

The *HCM 2010* provides a more detailed analysis procedure than previous editions as it now has improved methods for calculating delays and queues as well as for analyzing intersections with actuated signals.

Known limitations of the HCM analysis procedures for signalized intersections exist under the following conditions:

- Available software products that perform HCM analyses generally do not accommodate intersections with more than four approaches.
- The analysis may not be appropriate for alternative intersection designs.
- The effect of queues that exceed the available storage bay length is not treated in sufficient detail, nor is the backup of queues that block a stop line during a portion of the green time.
- Driveways located within the influence area of signalized intersections are not recognized.
- The analysis does not explicitly account for travel lanes added just upstream or dropped just downstream of the intersection.
- The effect of arterial progression in coordinated systems is recognized, but only in terms of a coarse approximation.
- Heterogeneous effects on individual lanes within multilane lane groups (e.g., downstream taper, freeway on-ramp, driveways) are not recognized.

If any of these conditions exist, it may be necessary to proceed to the next level of analysis.

7.6 ARTERIAL AND NETWORK SIGNAL TIMING MODELS

7.6.1 Introduction

Arterial and network signal timing models are also macroscopic in nature. They do, however, deal with a higher level of detail and are more oriented to operational design than the HCM. Most of the macroscopic simulation models for signalized intersections are designed to develop optimum signal timing along an arterial. These models are usually used to improve progression between intersections. The effect of traffic progression between intersections is treated explicitly, either as a simple time-space diagram or a more complex platoon propagation phenomenon. In addition, these models can explicitly account for pedestrian actuations at intersections and their effect on green time for affected phases.

These models attempt to optimize some aspect of the system performance as a part of the design process. The two most common optimization criteria are quality of progression as perceived by the driver, and overall system performance, using measures such as stops, delay, and fuel consumption. As indicated in Exhibit 7-2, the optimized signal timing plan may be passed back to the HCM analysis or forward to the next level of analysis, which involves microscopic simulation.

While the signal timing models are more detailed than the HCM procedures in most respects, they are less detailed when it comes to determining the saturation flow rates. The HCM provides the computational structure for determining saturation flow rates as a function of geometric and operational parameters. On the other hand, saturation flow rates are generally treated as input data by signal timing models. The transfer of saturation flow rate data between the HCM and the signal timing models is therefore indicated in Exhibit 7-2 as a part of the data flow between the various analysis levels.

7.6.2 Developing a Macroscopic Simulation Model

Arterial and network models represent traffic flow by considering traffic stream characteristics like speed, flow and density and their relationship to each other. These macroscopic models do not track individual vehicles and their interactions, but rather employ equations of known traffic flow behavior on the roadway facility being analyzed. Versions of these models have been designed for specific types of facilities, but their application is usually limited to those unique applications (such as unconventional or alternate design configurations). Macroscopic analysis models are also limited by the inability of the embedded models to accurately model oversaturated conditions. Specifically, signalized intersection models have some limitations in estimating the delay experienced, number of stops, and queue length in oversaturated conditions. Some arterial and network model developers have attempted to overcome these issues by varying flow levels and performing input/output flow checks at intersections. However, the typical practice is to apply microscopic simulation models if the effects and extent of arterial or network congestion need to be analyzed.

Macroscopic models require the following four types of data to be collected.

- Traffic data comprising traffic volumes and turning movement counts are typically collected in 15-minute increments and usually the peak one hour count and the peak 15-minute count within that one hour will be identified as input data into the model. These counts are made for periods of interest within a day, which typically includes the AM peak, PM peak, and off-peak periods.
- Geometric data such as the number of lanes and lane assignment at the intersection, as well as turn bay presence and length.
- Phasing data that can be implemented will depend on existing geometry, signal head locations and configurations, and the signal controller's capabilities.
- Requirements of pedestrians and other intersection users like rail and transit will have a significant impact on signal timing.

The additional detail present in the signal timing models overcomes many of the limitations of the HCM for purposes of operational analysis of signalized intersections. It will not generally be necessary to proceed to the final analysis level, which involves microscopic simulation, unless complex interactions take place between movements or additional outputs, such as animated graphics, are considered desirable.

7.7 MICROSCOPIC SIMULATION MODELS

7.7.1 Introduction

For cases where individual cycle operations and/or individual vehicle operations are desired, a microscopic-level analysis should be considered to supplement the aggregate results provided by the less detailed analysis levels. Microscopic analyses are performed using one or more of an increasing range of available microsimulation software products. Microsimulation analysis tools are based on a set of rules used to propagate the position of vehicles from one time step (usually each second) to the next. Rules such as car following, lane changing, yielding, response to signals, etc., are an intrinsic part of each simulation software package. The rules are generally stochastic in nature; in other words, there is a random variability associated with multiple aspects of driver decision-making in the simulated environment. Some simulation models can explicitly model pedestrians, enabling the analyst to study the impedance effects of vehicles on pedestrians and vice versa.

Microscopic models produce similar measures of effectiveness as their macroscopic counterparts, although minor differences exist in the definition of some measures. Microscopic model results typically include pollutant discharge measures. Interestingly, one of the most important measures, capacity, is notably absent from simulation results because the nature of simulation models does not lend itself to capacity computations. Rather than being a model input, capacity is an outcome produced by the driver behavior rules intrinsic to the model and the modeler's calibration adjustments to realistically replicate field conditions.

Microscopic simulation models also can be used to identify a condition's duration, and can account for the capacity and delay effects associated with known system-wide travel patterns. Because microscopic models track the behavior of individual vehicles within a given roadway environment, they are often more realistic in representing traffic flow and queuing propagation under congested conditions than macroscopic tools. As a result, output measures of effectiveness for congested networks from microsimulation models are often more representative than those produced by macroscopic methods or tools.

Microscopic simulation tools can be particularly effective for cases where intersections are located within the influence area of adjacent signalized intersections and are affected by upstream and/or downstream operations. In addition, graphical simulation output may be desired to verify field observations and/or provide a visual description of traffic operations for an audience. Several modern simulation tools allow analysts to render their roadway network simulation in two or three dimensions, allowing the model to serve not only its analytical purpose but also as a demonstration and public involvement tool.

7.7.2 Developing a Microsimulation Model

In the past, the level of effort involved with developing a microscopic simulation network was greater than that of a macroscopic analysis, and significantly greater than a CLA. However, recently there have been significant strides in modeling tool integration and user interface development. Some macroscopic intersection analysis tools currently feature conversion utilities to generate a draft input file for a microsimulation model, or even feature the developer's own microsimulation model as part of an integrated traffic analysis and modeling suite. Like the HCM operational procedure, microscopic simulation tools require a fully specified signal-timing plan that must be generated externally; however, in the case of an integrated signal optimization and microsimulation modeling suite of tools, alternative timing plans can be developed and modeled at the microscopic level with the literal "press of a button." Unlike the HCM, calibration effort

using field data is essential to the production of credible results. For this reason, the decision of whether to use a microscopic simulation tool should be made on a case-by-case basis, considering the resources available for acquisition of the software and for collecting the necessary data for calibrating the model to the intersection being studied. The typical steps in a successful microsimulation modeling effort include:

Step 1—Identify the scope of the model. For signalized intersections or arterials, this will include the subject intersection or roadway corridor and adequate length of roadway segments at the model boundaries to permit lane changing and full queue storage for signalized and unsignalized intersections (including driveways, etc.) in the model.

Step 2—Collect and organize field data. Data requirements include traffic volume data (either roadway directional counts and intersection turning movements counts, or roadway counts and origin-destination routing data, depending on model type), geometric data (road segment lengths and number of lanes, length and number of turn bays, etc.) and traffic control data (lane markings, signing, signals and their timing plans). Field performance measures such as arterial average speed or average queue lengths should also be collected, as these measures are commonly used for model calibration and validation.

Step 3—Develop the current condition, or base, model in the microsimulation tool. Note that almost all modern microsimulation models allow analysts to create their networks by “drawing” them over scaled background aerial photography, greatly reducing model development time.

Step 4—Verify that the model performs as observed in the field, correcting any logical or coding errors where present and re-running the model. Calibration adjustments to aspects of the driver behavior model(s) may be necessary to accurately reflect field conditions; all such adjustments must be documented.

Step 5—Validate the model. Microsimulation model validation is an essential step in producing credible results. Validation typically takes the form of statistical tests comparing average output from multiple runs of the microsimulation model and the same output measures collected in the field (see Step 2).

Step 6—Perform final current condition model runs and summarize output. The number of runs to perform in generating the final performance measures are affected by network size and performance variability, with larger networks and congested networks requiring more modeling runs to ensure statistically valid results. At least five (5) microsimulation modeling runs should be performed as a general rule, and the results averaged for presentation.

Step 7—Develop alternatives. Using the current/base model as a departure point, create a new version of the network for each set of alternative conditions requiring analysis. Ensure that the same calibration settings used in the validated, current condition model are used for all alternatives.

Step 8—Perform final runs of alternative model(s) and summarize output. As in Step 6, the number of final runs for each alternative is dependent on network size and performance variability. Typical practice is to perform the same number of runs of each alternative model as were conducted for the base model.

Step 9—Presentation and reporting. As with any analysis process, the final step in using microsimulation models is the presentation of output measures of performance and the assessment of alternatives based on those measures. The two- or three-dimensional renderings of the modeled network possible with modern microsimulation tools can be a valuable method for familiarizing professionals and the public with the modeling process and increasing audience confidence in both the tool and its results.

7.8 OPERATIONAL PERFORMANCE MODEL SELECTION

Situations vary widely based on a multitude of factors. Practitioners should strive to choose the right tool for their intersection needs. Often models can be combined in some way by practitioners to address their particular situation.

The first step is identification of the analytical context for the task: planning, design, or operations/construction. Seven additional criteria are necessary to help identify the analytical tools that are most appropriate for a particular project. Depending on the analytical context and the project's goals and objectives, the relevance of each criterion may differ. The criteria include:

1. Ability to analyze the appropriate **geographic scope** or study area for the analysis, including isolated intersection, single roadway, corridor, or network.
2. Capability of modeling various **facility types**, such as freeways, high-occupancy vehicle (HOV) lanes, ramps, arterials, toll plazas, etc.
3. Ability to analyze various **travel modes**, such as single-occupancy vehicle (SOV), HOV, bus, train, truck, bicycle, and pedestrian traffic.
4. Ability to analyze various **traffic management strategies and applications**, such as ramp metering, signal coordination, incident management, etc.
5. Capability of estimating **traveler responses** to traffic management strategies, including route diversion, departure time choice, mode shift, destination choice, and induced/foregone demand.
6. Ability to directly produce and output **performance measures**, such as safety measures (crashes, fatalities), efficiency (throughput, volumes, vehicle-miles of travel (VMT)), mobility (travel time, speed, vehicle-hours of travel (VHT)), productivity (cost savings), and environmental measures (emissions, fuel consumption, noise).
7. **Tool/cost-effectiveness** for the task, mainly from a management or operational perspective. Parameters that influence cost-effectiveness include tool capital cost, level of effort required, ease of use, hardware requirements, data requirements, animation, etc.

Exhibit 7-11 summarizes the criteria that may be considered for the selection of a tool category.

Analytical Context Planning, Design, or Operations/Construction						
1	2	3	4	5	6	7
Geographic Scope	Facility Type	Travel Mode	Management Strategy	Traveler Response	Performance Measures	Tool Cost-Effectiveness
What is your study area?	Which facility types do you want to include?	Which travel modes do you want to include?	Which management strategies should be analyzed?	Which traveler responses should be analyzed?	What performance measures are needed?	What operational characteristics are necessary?
<ul style="list-style-type: none"> ✦ Isolated Location ✦ Segment ✦ Corridor/ Small Network ✦ Region 	<ul style="list-style-type: none"> ✦ Isolated Intersection ✦ Roundabout ✦ Arterial ✦ Highway ✦ Freeway ✦ HOV Lane ✦ HOV Bypass Lane ✦ Ramp ✦ Auxiliary Lane ✦ Reversible Lane ✦ Truck Lane ✦ Bus Lane ✦ Toll Plaza ✦ Light-Rail Line 	<ul style="list-style-type: none"> ✦ SOV ✦ HOV (2, 3, 3+) ✦ Bus ✦ Rail ✦ Truck ✦ Motorcycle ✦ Bicycle ✦ Pedestrian 	<ul style="list-style-type: none"> ✦ Freeway Mgmt ✦ Arterial Intersections ✦ Arterial Mgmt ✦ Incident Mgmt ✦ Emergency Mgmt ✦ Work Zone ✦ Special Event ✦ APTS ✦ ATIS ✦ Electronic Payment ✦ RFX ✦ CVO ✦ AVCSS ✦ Weather Mgmt ✦ TDM 	<ul style="list-style-type: none"> ✦ Route Diversion <ul style="list-style-type: none"> - Pre-Trip - En Route ✦ Mode Shift ✦ Departure Time Choice ✦ Destination Change ✦ Induced/ Foregone Demand 	<ul style="list-style-type: none"> ✦ LOS ✦ Speed ✦ Travel Time ✦ Volume ✦ Travel Distance ✦ Ridership ✦ AVO ✦ V/C Ratio ✦ VMT/PMT ✦ VHT/PHT ✦ Delay ✦ Queue Length ✦ # Stops ✦ Crashes/ Duration ✦ TT Reliability ✦ Emissions/ Fuel Consump ✦ Noise ✦ Mode Split ✦ Benefit/Cost 	<ul style="list-style-type: none"> ✦ Tool Capital Cost ✦ Effort(Cost/ Training) ✦ Ease of Use ✦ Popular/Well-Trusted ✦ Hardware Requirement ✦ Data Requirement ✦ Computer Run Time ✦ Post-Processing ✦ Documentation ✦ User Support ✦ Key Parameters User Definable ✦ Default Values ✦ Integration ✦ Animation/ Presentation

Exhibit 7-11. Criteria for selecting a traffic analysis tool category.
Source: FHWA *Traffic Analysis Tools, Volume 2*, 2004.

Situations vary widely based on a multitude of factors. Practitioners should strive to choose the right tool for their intersection needs. Additional guidance is available from the *FHWA Traffic Analysis Tools* website at http://ops.fhwa.dot.gov/trafficanalysistools/tat_vol2/index.htm.

Part III

Treatments

Part III includes a description of treatments that can be applied to signalized intersections to mitigate an operational and/or safety deficiency. The treatments are organized as follows: System-Wide Treatments (Chapter 8), Intersection-Wide Treatments (Chapter 9), Approach Treatments (Chapter 10), and Individual Movement Treatments (Chapter 11). It is assumed that before readers begin to examine treatments in Part III, they will already have familiarized themselves with the fundamental elements described in Part I and the project process and analysis methods described in Part II.

CHAPTER 8

SYSTEM-WIDE TREATMENTS

TABLE OF CONTENTS

8.0	SYSTEM-WIDE TREATMENTS	8-3
8.1	Median Treatments	8-3
8.1.1	Description	8-3
8.1.2	Applicability	8-3
8.1.3	Key Design Features	8-3
8.1.4	Safety Performance	8-9
8.1.5	Operational Performance	8-9
8.1.6	Multimodal Impacts	8-9
8.1.7	Physical Impacts	8-10
8.1.8	Socioeconomic Impacts	8-10
8.1.9	Enforcement, Education, and Maintenance	8-10
8.1.10	Summary	8-11
8.2	Access Management	8-13
8.2.1	Description	8-13
8.2.2	Applicability	8-14
8.2.3	Design Features	8-14
8.2.4	Safety Performance	8-19
8.2.5	Operational Performance	8-20
8.2.6	Multimodal Impacts	8-20
8.2.7	Physical Impacts	8-20
8.2.8	Socioeconomic Impacts	8-20
8.2.9	Enforcement, Education, and Maintenance	8-21
8.2.10	Summary	8-21
8.3	Signal Coordination	8-22
8.3.1	Description	8-22
8.3.2	Applicability	8-23
8.3.3	Safety Performance	8-23
8.3.4	Operational Performance	8-23
8.3.5	Multimodal Impacts	8-24
8.3.6	Physical Impacts	8-24
8.3.7	Socioeconomic Impacts	8-24
8.3.8	Enforcement, Education, and Maintenance	8-25
8.3.9	Summary	8-25
8.4	Signal Preemption and/or Priority	8-25
8.4.1	Description	8-25
8.4.2	Emergency Vehicle Preemption	8-25
8.4.3	Railroad Preemption	8-26
8.4.3	Transit Vehicle Preemption	8-26
8.4.5	Applicability	8-27
8.4.6	Safety Performance	8-27
8.4.7	Operational Performance	8-27
8.4.8	Multimodal Impacts	8-27
8.4.9	Physical Impacts	8-27
8.4.10	Socioeconomic Impacts	8-28
8.4.11	Enforcement, Education, and Maintenance	8-28
8.4.12	Summary	8-28

LIST OF EXHIBITS

8-1	Issues associated with intersections with a narrow median	8-4
8-2	Issues associated with intersections with a wide median.....	8-5
8-3	Median pedestrian treatments	8-7
8-4	Pedestrian signal treatments where medians are present	8-8
8-5	This refuge island enables two-stage pedestrian crossings.....	8-9
8-6	Summary of issues for providing median treatments	8-12
8-7	Comparison of physical and functional areas of an intersection	8-14
8-8	Diagram of the upstream functional area of an intersection.....	8-15
8-9	Access points near signalized intersections	8-17
8-10	Access management requiring U-turns at a downstream signalized intersection.....	8-18
8-11	Access management requiring U-turns at an unsignalized, directional median opening.	8-18
8-12	Relative crash rates for unsignalized intersection access spacing	8-19
8-13	Summary of issues for providing access management.....	8-22
8-14	Selected findings of safety effects associated with signal coordination or progression ...	8-23
8-15	Summary of issues for providing signal coordination	8-25
8-16	Summary of issues for providing signal preemption and/or priority.....	8-28

8.0 SYSTEM-WIDE TREATMENTS

Treatments in this chapter apply to roadway segments located within the influence of signalized intersections and intersections affected by the flow of traffic along a corridor. These treatments primarily address safety deficiencies associated with rear-end collisions due to sudden accelerating/decelerating; turbulence involved with midblock turning movements from driveways or unsignalized intersections; and coordination deficiencies associated with the progression of traffic from one location to another. The following specific treatments are examined:

1. Median treatments.
2. Access management.
3. Signal coordination.
4. Signal preemption and/or priority.
5. Automated enforcement.

8.1 MEDIAN TREATMENTS

The median of a roadway is used for left turns, pedestrian refuge, restriction of or access to properties on the other side of the road, and separation of opposing directions of travel. These purposes can conflict, and each use should be considered when design changes are proposed. Medians can be either flush or raised, each having specific operational and safety characteristics that may lead to tradeoffs in either.

8.1.1 Description

Median design contributes to safe and efficient operation of corridors and intersections, especially left-turn and pedestrian movements. Specifically, width, height, length, and type are key factors in median design. The median provides a location for vehicles to wait for a gap in opposing traffic through which to turn; it also separates opposing directions of travel. Medians may also provide a refuge for pedestrians. Inappropriate median design may contribute to operational or safety problems related to vehicles turning left from the major road and vehicles proceeding through or turning left from the minor road and public or private entrances.

8.1.2 Applicability

Operational or safety issues that could be addressed by median design changes include spillover of left-turn lanes into the through traffic stream, rear-end or side-swipe crashes involving left-turning vehicles, inappropriate use of the median, and pedestrian crashes. Medians may also form an integral part of an overall access management plan, as discussed later.

8.1.3 Key Design Features

Width, height, length, channelization, end type, and pedestrian treatments are key features of a median design. The elements combine to provide storage for left-turning vehicles, guide turning vehicles through the intersection, and help pedestrians cross the street.

Median Width

Medians physically separate opposing directions of travel and provide a safety benefit by helping reduce occurrence of head-on collisions. It is possible that a median can be so narrow or so wide that its safety benefit is negated by operational or safety problems created by an inappropriate width, as shown in Exhibits 8-1 and 8-2.

- **Narrow medians:** Many problems associated with medians that are too narrow relate to unsignalized intersections upstream or downstream of the signalized intersection in question. These include vehicles stopping in the median at an angle instead of perpendicular to the major road, or long vehicles stopping in the median and encroaching on major road through lanes. Additionally, pedestrians can have difficulty at signalized intersections with medians that are too narrow. At large intersections with medians, pedestrians commonly cross the street in two stages. If the median width is too narrow, pedestrians may not have sufficient room to wait safely and comfortably. Also, there may be insufficient room to provide adequate ADA-compliant detectable warning surfaces and, in some cases, curb ramps.
- **Wide medians:** Just as medians that are too narrow can pose difficulties, overly wide medians also can be problematic. At signalized intersections, wide medians increase motor vehicle and bicycle clearance time, thus adding lost time and delay to the intersection. If pedestrians are expected to cross the entire intersection in one crossing, overly wide medians result in very long pedestrian clearance times, which often lead to excessively long cycle lengths.

Wide medians also can create visibility problems for signal displays, which often result in the use of two sets of signal indications: one mid-intersection, and one on the far side. Extremely wide medians can also cause driver confusion with respect to how motorists are to maneuver turns. Extra pavement marking, island delineation and/or signing may be needed to guide motorists. These factors increase the cost of construction and operation of the intersection.

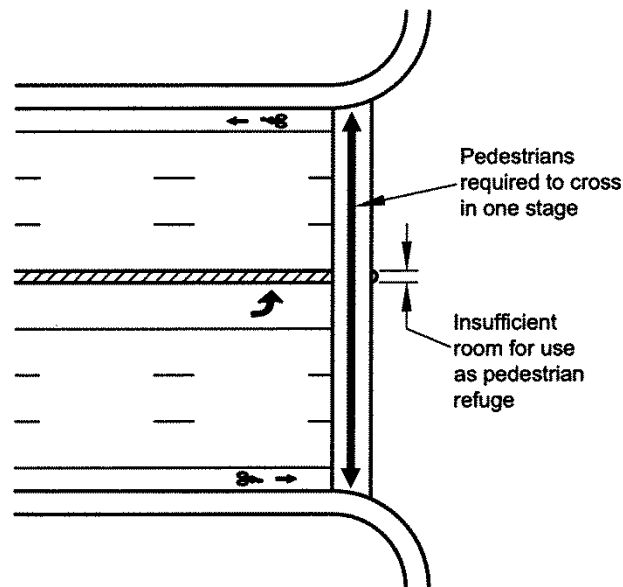

Exhibit 8-1. Issues associated with intersections with a narrow median.

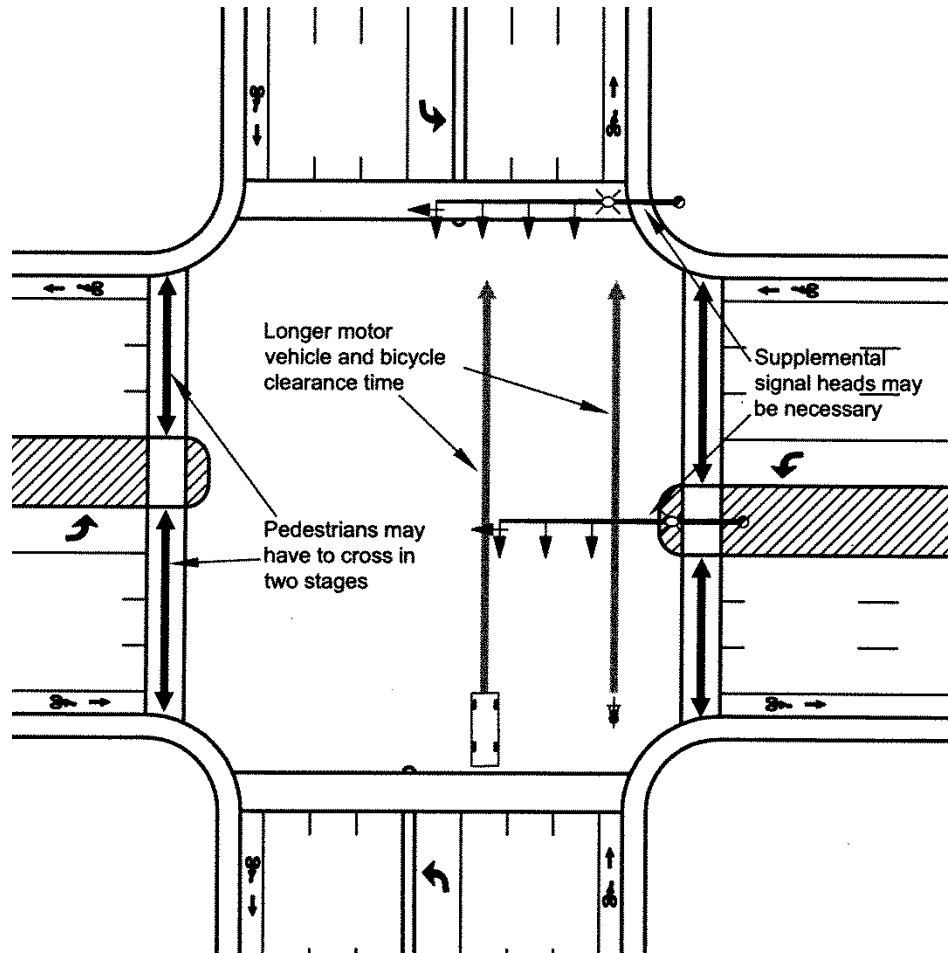

Exhibit 8-2. Issues associated with intersections with a wide median.

Median Channelization

The appropriateness of the use of raised or flush medians depends on conditions at a given intersection. Raised (curbed) medians should provide guidance in the intersection area but should not present a significant obstruction to vehicles. The design should be balanced between the desire for it to be cost effective to construct and maintain and for it to provide safe channelization. Raised medians may be delineated with reflectors, tape, or paint, in addition to the presence of lighting.

AASHTO recommends that flush medians are appropriate for intersections with:⁽³⁾

- Relatively high approach speeds.
- No lighting.
- Little development where access management will not be considered.
- No sign, signal, or luminaire supports in the median.
- Little/infrequent snowplowing operations.
- A need for left-turn storage space.
- Little or no pedestrian traffic.

Where left-turn lanes are provided in the median, raised medians should be used to separate left-turn and opposing through traffic on medians 14 to 16 ft wide or less. These raised medians should be 4 ft wide. Medians 18 ft wide or more should have a painted or physical divider that delineates the movements. It is also recommended that the left-turn lane be offset to provide improved visibility with opposing through traffic. This treatment is discussed in more detail in Chapter 11.

Median End Type

AASHTO provides the following guidance for median ends: ^(3, p. 701)

- Semicircular medians and bullet nose median ends perform the same for medians approximately 4 ft wide.
- Bullet-nose median ends are preferred for medians 10 ft or more wide.

A semicircle is an appropriate shape for the end of a narrow median. An alternative design is a bullet nose, which is based on the turning radius of the design vehicle. This design better guides a left-turning driver through the intersection because the shape of the bullet nose reflects the path of the inner rear wheel. The bullet nose, being elongated, better serves as a pedestrian refuge than does a semicircular median end.

Medians greater than 14 ft wide with a control radius of 40 ft (based on the design vehicle) should have the shape of flattened or squared bullets to provide channelization, though the length of the median opening will be controlled by the need to provide for cross traffic.

The median end controls the turning radius for left-turning vehicles. It can affect movement of vehicles using that leg of the intersection both to turn left from the approach and to depart from the intersection on that leg after turning left from the cross street. A median nose that does not significantly limit the turning radius will help turning vehicles proceed through the intersection at higher speeds. This could contribute to efficient vehicular operations but could also create additional safety issues for pedestrians, bicyclists, and through traffic on the opposing approach if permissive left turns are allowed.

Median Pedestrian Treatments

Careful attention should be given to pedestrian treatments at signalized intersections with medians, as these intersections tend to be larger than most. Two key treatments are discussed here: the design of the pedestrian passage through the median, and the design of the pedestrian signalization.

Pedestrian treatments at medians can be accommodated in two basic ways: a cut-through median, where the pedestrian path is at the same grade as the adjacent roadway; and a ramped median, where the pedestrian path is raised to the grade of the top of curb. Exhibit 8-3 shows the basic features and dimensions for each treatment. Note that if the median is too narrow to accommodate a raised landing of minimum width, a ramped median design cannot be used. If the median is so narrow that a pedestrian refuge cannot be accommodated, then the crosswalk should be located outside the median.

Cut-through and ramped medians both provide pedestrian refuge, but cut-through medians are susceptible to hold roadway drainage and resulting debris. If space allows for ramped medians, they can provide extra visibility to pedestrians by being vertically separated from the roadway. Both cut-through and ramped medians should be designed and operated in a way that provides visibility and conspicuity of pedestrians located in the median, as well as a line-of-sight from the median to roadway users. This is especially important when median landscaping is present. The landscaping must be maintained to provide pedestrians a line-of-sight over and around the landscaping and give motorists the opportunity to detect pedestrians in the median.

Per ADAAG, all curb ramps, including those at median crossings, must have detectable warnings. Further discussion of pedestrian treatments at medians can be found in FHWA's *Designing Sidewalks and Trails for Access: Part II.*⁽³⁷⁾

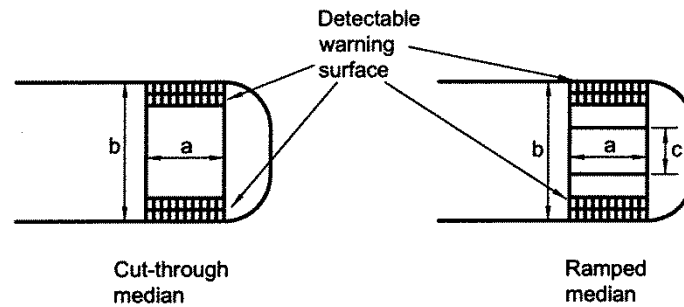

Key Dimensions: a: 915 mm (36 in) minimum, 1525 mm (60 in) preferred
 b: 1.22 m (48 in) minimum, 1.83 m (72 in) preferred for one-stage crossing; 1.83 m (72 in) minimum for two-stage crossing
 c: 1.22 m (48 in) minimum, 1.525 m (60 in) preferred

Exhibit 8-3. Median pedestrian treatments.⁽³⁷⁾

Exhibit 8-4 summarizes pedestrian signal treatments, which also depend on the width of the median.

- Narrow crossings providing no refuge require a one-stage crossing using a single set of pedestrian signal displays and detectors. For this option, pedestrian clearance time needs to accommodate crossing the entire roadway.
- Wide intersection crossings with ample room for pedestrians to wait in the median (and where it is advantageous to all users to cross in two stages) require separate pedestrian signal displays and detectors for each half of the roadway. Pedestrian clearance times are set independently for each half of the roadway, as shown in Exhibit 8-5.
- A third option is for crossings where part of the pedestrian population can be reasonably expected to cross in one stage, but others need two stages. For this option, pedestrian clearance time is set to accommodate crossing the entire roadway, but a supplemental pedestrian detector is placed in the median to accommodate pedestrians needing to cross in two stages.

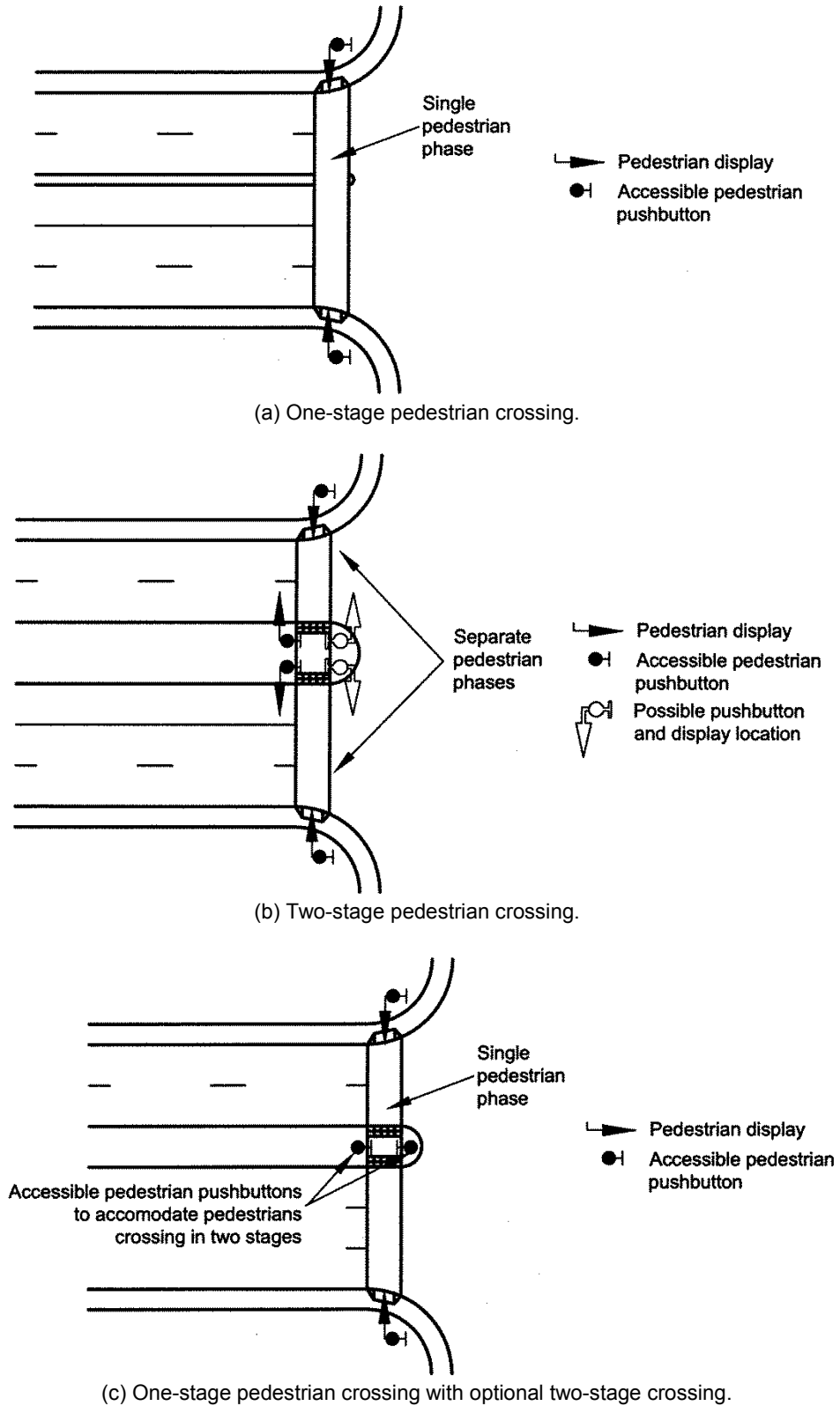

Exhibit 8-4. Pedestrian signal treatments where medians are present.



Exhibit 8-5. This refuge island enables two-stage pedestrian crossings.

Source: Michael Ronkin (*Safety Benefits of Raised Medians and Pedestrian Refuge Areas*, FHWA, 2010)

8.1.4 Safety Performance

Medians at intersections can provide safety benefits similar to medians between intersections. Introducing distance between opposing flows can decrease the frequency and severity of crashes. The presence of a raised median impacts motorists' ability to cross the opposing lanes, which can reduce head-on collisions. One report has shown that at urban and suburban intersections, multiple-vehicle crash frequency increases as median width increases for widths between 14 ft and 80 ft, unlike in rural areas where multiple-vehicle crash rates tend to be lower for wider medians.⁽⁸²⁾ The report also provided a summary of a study that found no statistically significant effect of median width on traffic delays and conflicts on medians between 30 ft and 60 ft wide.⁽⁸³⁾

One study found decreasing crash rates with increasing median widths.⁽⁸⁴⁾ A Michigan State University study found that Michigan's boulevard roadways experienced a crash rate half that of roadways with continuous center left-turn lanes.⁽⁸⁵⁾ A median width of 30 ft to 60 ft was found to be the most effective in providing a safe method for turning left.

The frequency of minor collisions and vehicle damage claims may increase when raised medians are present as a result of drivers misinterpreting their distance from the raised median.

8.1.5 Operational Performance

Simulation of signalized directional crossovers showed they operate better than other designs (specifically, an undivided cross section with a continuous center left-turn lane and a boulevard with bidirectional crossovers). The undivided cross section has larger delays for left-turning vehicles than do boulevard roadways, even for low turn volumes. The width of the median affects the storage capacity of the crossover, so a crossover in a narrow median may not function as well as a left-turn lane. The signalized crossovers functioned more efficiently (i.e., with less time to make a left-turn) than did stop-controlled crossovers.⁽⁸⁶⁾

Depending on the radius design, the presence of a raised median may impact the speed at which motorists can maneuver left turning movements. A less severe radius will allow for higher speeds of left-turning traffic, which can help clear intersections of traffic more quickly and reduce cycle lengths and delay, but may have adverse effects on pedestrian and bicycle users.

8.1.6 Multimodal Impacts

As noted previously, the width of the median (and the roadway in general) directly impacts the amount of time needed for pedestrians and bicycles to cross the roadway. Large intersections with no median or a median too narrow to provide a refuge force pedestrians to cross the entire

street in one stage. Therefore, provision of a median with at least enough width to accommodate a pedestrian can provide the option of crossing in one stage or two. This can be a significant benefit to elderly and disabled pedestrians who cross at speeds less than the typical 4 ft/s used to time pedestrian clearance intervals.

If the median is so wide that pedestrian crossings are operated in two stages, the sequence of the stages may increase crossing time significantly. For example, if the vehicle phases running parallel to the pedestrian crossing in question are split-phased and the sequence of the vehicle phases is in the same direction as the pedestrian, crossing time is similar to that of a single-stage crossing. On the other hand, the reverse direction will result in additional delay to the pedestrian in the median area as the signal cycles through all conflicting phases.

8.1.7 Physical Impacts

Improvements in the median should not affect the footprint of an intersection unless a roadway is widened to provide the median to use for left-turn lanes, pedestrian refuges, and so on.

8.1.8 Socioeconomic Impacts

The primary socioeconomic impact of medians at signalized intersections relates more to their effect on overall access within the corridor, discussed in Section 8.2. The frequency of minor collisions and vehicle damage claims will likely increase when raised medians are installed; sometimes drivers misinterpret their vehicle's distance from the raised median.

Landscaping can play an important esthetic role at the intersection itself. The appropriate use of landscaping can visually enhance a road and its surroundings. Landscaping may act as a buffer between pedestrians and motorists and reduce the visual width of a roadway, serving to reduce traffic speeds and providing a more pleasant environment.

Landscaping must be carefully considered at signalized intersections, otherwise it will prevent motorists from making left and right turns safely because of inadequate sight distances. Care should be taken to ensure that traffic signals and signs, pedestrian crossings, nearby railroad crossings, and school zones are not obstructed. Median planting of trees or shrubs greater than 2 ft in height should be well away from the intersection (more than 50 ft). No plantings having foliage between 2 ft and 8 ft in height should be present within sight distance triangles.

Low shrubs or plants not exceeding a height of 2 ft are appropriate on the approaches to a signalized intersection, either on the median, or along the edge of the roadway. These should not be allowed to overhang the curb onto the pavement nor interfere with the movement of pedestrians. All plantings should have adequate watering and drainage systems or be drought resistant. FHWA's report *Vegetation Control for Safety* provides additional guidelines and insight.⁽⁸⁷⁾

In addition to landscaping height considerations, AASHTO's Roadside Design Guide provides guidance to establish an enhanced lateral offset distance to signs, poles, trees, plants, and shrubbery located within the median. Specifically, the enhanced lateral offset is intended to provide an additional level of protection for roadway users at high-risk locations, such as at locations where lanes merge or at driveways and medians are present. The recommended enhanced lateral offset distance is 4 to 6 ft.

8.1.9 Enforcement, Education, and Maintenance

Flush medians introduce little in the way of unique enforcement or education issues for motor vehicles. However, the enforcement of signalized corridors with continuous raised medians will vary from corridors with median breaks or flush medians that allow enforcement to access both directions of traffic. Practitioners should coordinate with enforcement to discuss these concerns or find locations for median opening turnarounds or flush medians. Pedestrians may need assistance through the use of signs or other methods to make them aware of one-stage versus

two-stage crossings, particularly in communities that have both types of crossings at signalized intersections.

Typical maintenance procedures will apply to medians. However, consideration should be given for providing vertical guidance for snow removal operations on raised medians using delineation. The addition of a raised median will also result in a treatment located among roadway users that will require intermittent maintenance. Landscaping should be maintained so as not to obstruct sight distance.

8.1.10 Summary

Exhibit 8-6 summarizes issues associated with providing median treatments.

Exhibit 8-6. Summary of issues for providing median treatments.

Characteristic	Potential Benefits	Potential Liabilities
Safety	Introducing distance between opposing flows may allow for a reduction in the frequency and severity of certain crash types.	The frequency of minor collisions may increase when raised medians are present.
Operations	Signalized directional crossovers can operate more efficiently than unsignalized directional crossovers. Appropriately designed median radii can help raise speeds in turning movements and decrease intersection delay.	Narrow medians may create storage problems. For intersections where high pedestrian volumes are present, increased motorist speeds could negatively impact pedestrian safety.
Multimodal	Medians of moderate width can allow pedestrians to cross in one or two stages, depending on ability.	Overly wide medians may require all pedestrians to cross in two stages, significantly increasing pedestrian delay. Narrow medians may require long one-stage crossings.
Physical	None identified.	Changes to median width may have a substantial physical impact upstream and downstream of the intersection. Presence of a raised median requires additional roadway maintenance.
Socioeconomic	Landscaping may provide visual appeal.	Access control upstream or downstream of the intersection may create challenges. The frequency of vehicle damage claims may increase. Potential safety concern if the landscaping becomes a fixed object hazard or impedes sight distance.
Enforcement, Education, and Maintenance	None identified.	Education on the use of pedestrian push buttons in the median may be considered. Presence of a raised median and landscaping in the median will require maintenance. Enforcement methods may need to be addressed, depending on the presence of raised median between signals.

8.2 ACCESS MANAGEMENT

Practical experience and recent research indicate that controlling access on a roadway can positively impact traffic flow and safety. Access management is a key issue in planning and designing roadways so they perform according to their functional classification.

The topic of access management is growing and exceeds the space that this guide can provide. More information on access management can be found in a number of references, including AASHTO's *A Policy on Geometric Design of Highways and Streets*⁽³⁾; NCHRP 420: *Impacts of Access Management Techniques*⁽⁸⁸⁾; ITE's *Transportation and Land Development*⁽⁸⁹⁾; and TRB's *Access Management Manual*.⁽⁹⁰⁾ Many States also have extensive guidance on access management. This section focuses on the operational and safety effects of unsignalized intersections (both public streets and private driveways) located within the vicinity of signalized intersections.

8.2.1 Description

Access management plays an important role in the operation and safety of arterial streets needing both mobility of through traffic and access to adjacent properties. Studies have repeatedly shown that improvements in access management improve safety and capacity, and also that roadways with poor access management have safety and operations records worse than those with better control of access. Treatments to improve access management near intersections (within 250 ft upstream or downstream) include changes in infrastructure, geometry, or signing to close or combine driveways, provide turn lanes, or restrict or relocate turn movements.

TRB's *Access Management Manual* states that access management programs seek to limit and consolidate access along major roadways, while promoting a supporting street system and unified access and circulation systems for development. The result is a roadway that functions safely and efficiently for its useful life, and a more attractive corridor. The goals of access management are accomplished by applying the following principles⁽⁹⁰⁾:

- Provide a specialized roadway system.
- Limit direct access to major roadways.
- Promote intersection hierarchy.
- Locate signals to favor through movements.
- Preserve the functional area of intersections and interchanges.
- Limit the number of conflict points.
- Separate conflict areas.
- Remove turning vehicles from through-traffic lanes.
- Use non-traversable medians to manage left-turn movements.
- Provide a supporting street and circulation system.

For more information on Access Management, consider the following resources:

- AASHTO *A Policy on Geometric Design of Highways and Streets*
- ITE *Transportation and Land Development*
- Transportation Research Board's *Access Management Manual*
- FHWA's 2007 *Compendium of Access Management Tools*
- NCHRP 420: *Impacts of Access Management Techniques*
- NCHRP Synthesis 304: *Driveway Regulation Practices*
- NCHRP Synthesis 337: *Cooperative Agreements for Corridor Management*
- NCHRP Report 348: *Access Management Guidelines for Activity Centers*
- NCHRP Synthesis 351: *Access Rights*
- NCHRP Report 395: *Capacity and Operational Effects of Midblock Left-Turn Lanes*
- NCHRP Report 524: *Safety of U-Turns at Unsignalized Median Openings*
- NCHRP Report 548: *Median Intersection Design for Rural High-Speed Divided Highways*

Access management works best when combined with land use and zoning policies. Agencies can also regulate aspects of access management through geometric design and ingress/egress spacing.

8.2.2 Applicability

Examples of when to improve access management at an intersection include situations where through vehicles experience delay due to vehicles turning left or right into intersections, such as from major and minor streets (signalized and unsignalized) and from driveways, and when rear-end or angle crashes occur involving vehicles entering or leaving driveways.

8.2.3 Design Features

Practitioners should determine the functional area of the signalized intersection, as shown in Exhibit 8-7, to understand the upstream and downstream effects of a signalized intersection on access management. The functional area is larger than the physical area of the intersection because it includes several items, as shown in Exhibit 8-8.⁽⁹⁰⁾

- Distance $d1$: Distance traveled during perception-reaction time as a driver approaches the intersection, assuming 1.5 s for urban and suburban conditions and 2.5 s for rural conditions.
- Distance $d2$: Deceleration distance while the driver maneuvers to a stop upstream of the intersection.
- Distance $d3$: Queue storage at the intersection.
- Distance immediately downstream of the intersection so that a driver can completely clear the intersection before needing to react to something downstream (stopping sight distance is often used for this).

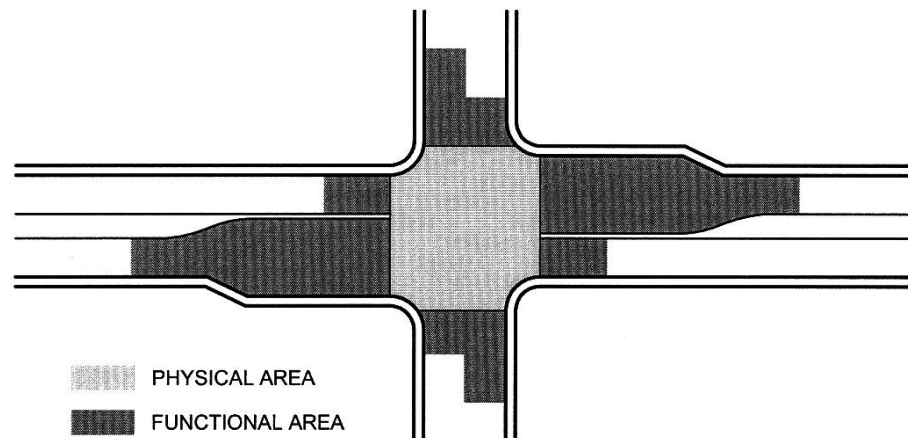

Exhibit 8-7. Comparison of physical and functional areas of an intersection.⁽⁹⁰⁾

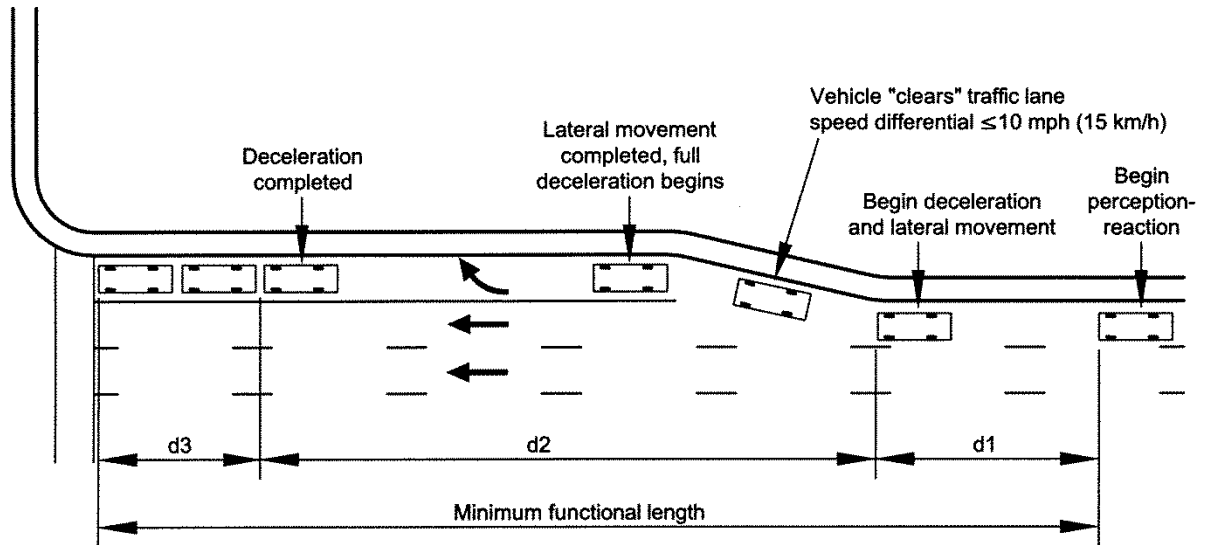

Exhibit 8-8. Diagram of the upstream functional area of an intersection.⁽⁹⁰⁾

Consider overlapping functional areas' varying levels of access when addressing two proximal signalized intersections. Exhibit 8-9 shows how the functional areas of nearby signalized intersections affect the location and extent of feasible access. Ideally, driveways with full access should be located outside of the functional areas of both signalized intersections. However, signalized intersections are often located close enough to each other that the downstream functional area of one intersection overlaps with the upstream functional area of the other. In these cases, there is no clear area between the two intersections where a driveway can operate without infringing upon the functional area of one of the signalized intersections. As such, practitioners should apply sound engineering judgment regarding where and if to allow a driveway. Some important considerations in the evaluation include:

- The volume and type of traffic using the driveway.
- The type of turning maneuvers that will be most prominent.
- The type of median present and potential conflicts with and proximity to other driveways.
- The types and severity of existing crashes in the vicinity.
- The volume of traffic on the major street.

Access points clear of only one of the two signalized intersections would likely perform best from a safety perspective if restricted to right-in, right-out operation. However, in urban areas, this may not always be practical or may create other problems at downstream intersections, so again it is important to apply sound engineering judgment. In some cases, the two signalized intersections may be so close together that any access would encroach within the functional area of the intersections. These situations are likely candidates for either partial or full access restriction. It is important to note that driveways should not be simply eliminated based on general guidelines but rather should be evaluated on a case-by-case basis with consideration of the broader system effects. When driveways are closed without any regard to the system effects, there is a high potential that the problem will be transferred to another location. Finally, as a general guideline, the functional area of an intersection is more critical along corridors with high speeds (45 mph or greater) and whose primary purpose is mobility. If the corridor has a two-way left-turn lane design and driveways are placed indiscriminately, there is a high likelihood for angle crashes, and safety becomes the driving factor.

Improvements to the current access to properties adjacent to an intersection area can be implemented by:

- Closing, relocating, or combining driveways.
- Restricting turning movements through the use of median treatments, using driveway treatments, and/or the installation of signing.

As discussed previously, where access is restricted, the redirection of driveway traffic needs to be considered. Two of the more typical options are:

- Require drivers to make a U-turn at a downstream, signalized intersection (Exhibit 8-10). This requires adequate cross-section width to allow the U-turn and sufficient distance to the downstream intersection to weave across the through travel lanes. In addition to increasing the traffic volumes at the signalized intersection, U-turns also decrease the saturation flow rate of the left-turn movement. These combined effects potentially decrease the available capacity at the signalized intersection if the affected left-turn movement is a critical movement at the intersection.
- Create a midblock opportunity for drivers to make an unsignalized U-turn maneuver via a directional median opening (Exhibit 8-11). A study in Florida evaluated the safety effect of these directional median openings on six-lane divided arterials with large traffic volumes, high speeds, and high driveway/side-street access volumes.⁽⁹¹⁾ This study found a statistically significant reduction in the total crash rate of 26.4 percent as compared with direct left turns.

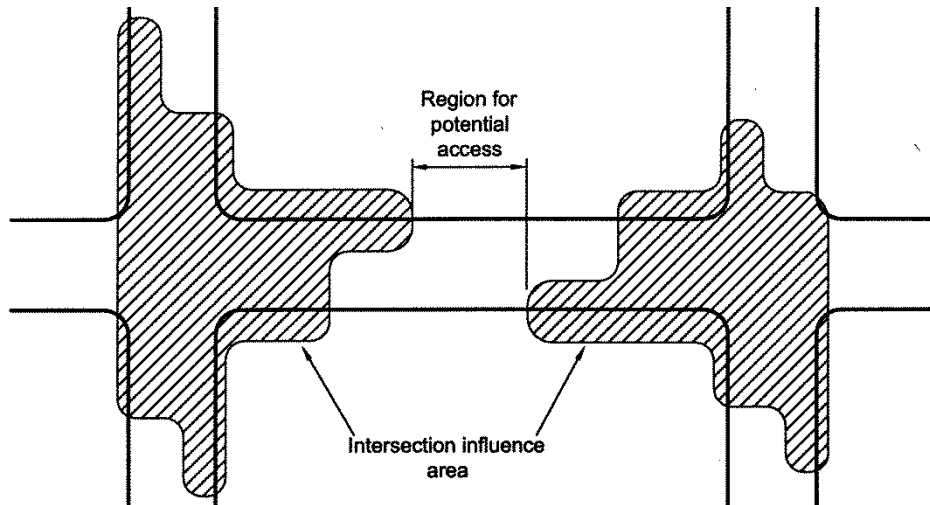

(a) Minimal amount of potential adverse effects due to adjacent signalized intersections.

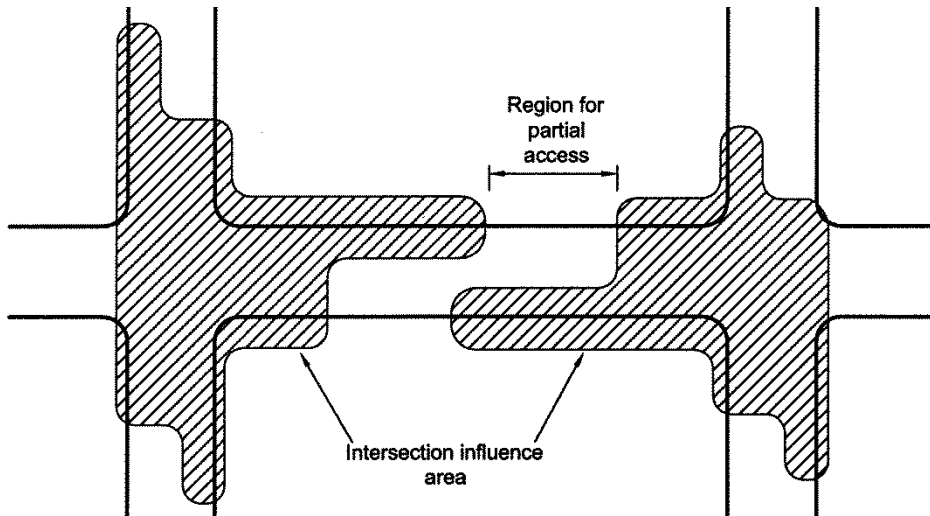

(b) Moderate amount of potential adverse effects due to adjacent signalized intersections.

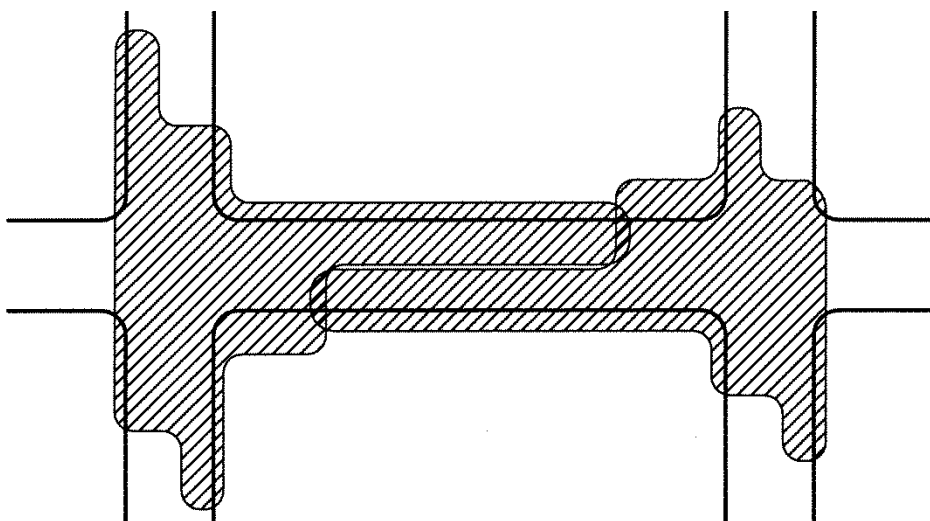

(c) Substantial amount of potential adverse effects due to adjacent signalized intersections.

Exhibit 8-9. Access points near signalized intersections. (adapted from 90, figure 8-15)

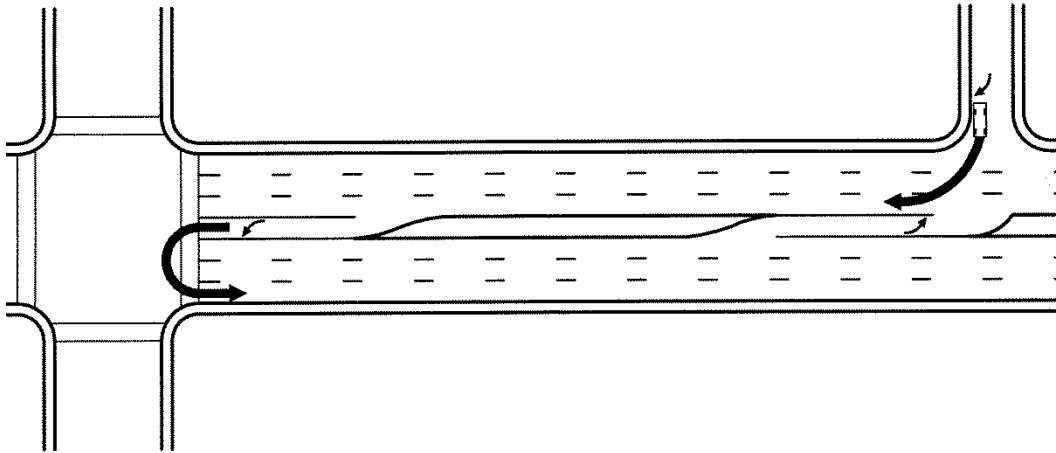

Exhibit 8-10. Access management requiring U-turns at a downstream signalized intersection.

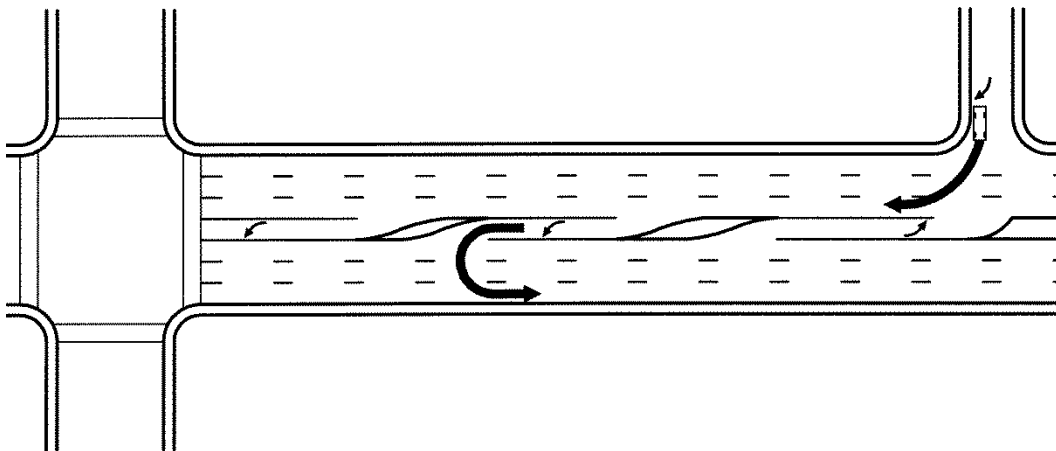

Exhibit 8-11. Access management requiring U-turns at an unsignalized, directional median opening.

Note that the conversion of an existing full-access point to right-in/right-out operation has both advantages and disadvantages. The advantages of right-in/right-out operation include:

- Removal of movements from the functional area of the signalized intersection. This reduces conflicts near the signalized intersection and improves capacity by minimizing discord in driver maneuvers.
- Better operation for the driveway. Eliminating left turns out of the driveway generally reduces delays for the driveway movements.

Disadvantages include:

- Increase in U-turn movements at signalized intersections or at other unsignalized locations. This may reduce the available capacity at the intersection and increase delay. This may also increase the potential for left-turn crashes at the location of the U-turn.
- Increase in arterial weaving. This may happen as the driveway movement attempts to get into position to make the U-turn.
- Potential for increased demand for left turns at other driveways serving the same property.

As with other access management treatments, involvement of property owners in the decision-making and design process is key to the success of the project.

8.2.4 Safety Performance

In general, an increase in the number of access points along a roadway correlates with higher crash rates. Specific relationships vary based on specific roadway geometry (lane width, presence or absence of turn lanes, sight distance, etc.) and traffic characteristics.

Exhibit 8-12 presents a summary of the relative crash rates for a range of unsignalized intersection access spacing. As can be seen, doubling access frequency from 10 to 20 access points per mile increases crash rates by about 40 percent. An increase from 10 to 60 access points per mile would be expected to increase crash rates by approximately 200 percent. Generally, each additional access point per mile along a four-lane roadway increases the crash rate by about 4 percent (see also references 92 and 93).

Exhibit 8-12. Relative crash rates for unsignalized intersection access spacing.*

Unsignalized Access Points Spacing**	Average Spacing***	Relative Crash Rate****
10 per mi	1056 ft	1.0
20 per mi	528 ft	1.4
30 per mi	352 ft	1.8
40 per mi	264 ft	2.1
50 per mi	211 ft	2.4
60 per mi	176 ft	3.0
70 per mi	151 ft	3.5

*Source: Reference 90, as adapted from 88.

**Total access connections on both sides of the roadway.

*** Average spacing between access connections on the same side of the roadway; one-half of the connections on each side of the roadway.

**** Relative to the crash rate for 10 access points per mi.

Removing or limiting access to restrict specific movements, such as right-in/right-out access, both have positive impacts to crash severity, congestion, and operational speeds. In *Safe Access is Good for Business*, FHWA states that where access is well-managed operating speeds are 15-20 mph higher. Restricting movements may require adding horizontal and vertical features, such as raised islands, which may contribute to an increase in fixed object crashes.⁽¹⁹⁹⁾

8.2.5 Operational Performance

Reducing access along an arterial street can improve traffic operations. For example, urban arterials with a high degree of access control function 30 to 50 percent better than the same facility with no control.⁽⁹⁴⁾ Improved access management also has been shown to improve LOS.⁽⁹⁵⁾ Controlling the flow of traffic through restricting and managing accesses can reduce delay.

Access points close to a signalized intersection can reduce the saturation flow rate of the signalized intersection. Research has determined that the amount of reduction depends on the corner clearance of the driveway, the proportions of curb-lane volume that enter and exit the driveway, and the design of the driveway itself.⁽⁹⁶⁾

However, as indicated earlier, practitioners should evaluate the impact of access control on the upstream and downstream intersections, which may experience a significant increase in U-turns or other types of turning movements. For example, eliminating left-turn movements and converting them to U-turns at signalized intersections could degrade arterial operational performance if adequate capacity to accommodate the turning movements at midblock access driveways exists, because less green time will be available for through traffic. This could substantially reduce capacity and increase delay at the signalized intersection.

8.2.6 Multimodal Impacts

Access treatments that reduce the number of driveways or restrict turning movements at driveways also reduce the number of potential conflicts for pedestrians and bicycles near a signalized intersection. In addition, a median treatment used as part of an overall access management strategy also provides the opportunity for a midblock signalized or unsignalized pedestrian crossing. Practitioners should evaluate whether the considered access treatments would result in a significant increase in operating speed on the facility, as increases in speed have a negative impact on both pedestrians and bicyclists that should be considered in the evaluation.

8.2.7 Physical Impacts

Several solutions exist for access management that can affect the footprint of the intersection area. The addition of U-turn lanes for property access will increase the roadway width of the intersection area. Turn restrictions may affect the physical size of an area if a vertical element is added to the intersection (for example a raised curb, median barrier, or flexible delineators used to prohibit left turns). In order for these not to present difficulties for pedestrians with mobility impairments, it may be necessary to provide a cut through.

8.2.8 Socioeconomic Impacts

Literature review indicates inconsistency in the socioeconomic effects of access management. Surveys conducted in Florida reported a relatively low rate of acceptance of access management: most drivers felt that the inconvenience of indirect movements offset the benefits to traffic flow and safety. Businesses also were unresponsive: 26 percent reported a loss in profits, and 10 to 12 percent reported a large loss.⁽⁹⁷⁾ Conversely, experience in Iowa indicates rapid growth in retail sales after access management projects were completed. An opinion survey conducted among affected motorists indicated that a strong majority supported all projects but one.⁽⁹⁵⁾ In *Safe Access is Good for Business*, FHWA states that, where access is managed properly, operating speeds are 15 to 20 mph higher, which yields an increased exposure to more potential customers. The publication also states that "before and after" studies of businesses in Florida, Iowa, Minnesota, and Texas along highways where access has been managed found that the vast majority of businesses do as well or better after the access management projects are completed.

The reactions of drivers, property owners, pedestrians, and others concerned with access to properties adjacent to intersections vary widely. Access management strategies should be

considered in the context of a roadway corridor with the approval and backing of those affected or if significant safety and operational enhancements can be achieved. A decrease in crashes and traveler delay from applying access management principles can result in considerable societal savings.

Redesign, relocation or closing of driveways should be part of a comprehensive corridor access-management plan. The optimal situation is to avoid driveway conflicts before they develop. This requires coordination with local land use planners and zoning boards in establishing safe development policies and procedures. Avoidance of high-volume driveways near congested or otherwise critical intersections is desirable.

Highway agencies should also understand the safety consequences of driveway requests. The power of a highway agency to modify access provisions is derived from legislation that varies in its provision from State to State. Highway agencies generally do not have the power to deny access to any particular parcel of land, but many do have the power to require, with adequate justification, relocation of access points. Where highway agency powers are not adequate to deal with driveways close to intersections, further legislation may be needed.

8.2.9 Enforcement, Education, and Maintenance

Periodic enforcement may be needed to ensure that drivers obey restrictions at driveways where such restrictions cannot be physically implemented with raised channelization, such as signed prohibitions. If raised channelization is used corridor-wide, it may be necessary to team with enforcement to provide openings for emergency turnarounds.

Education other than appropriate signing should not be needed when implementing changes to access unless major changes to access management are made along a corridor, requiring a fundamental shift in driver behavior.

8.2.10 Summary

Exhibit 8-13 summarizes issues associated with providing access management.

Exhibit 8-13. Summary of issues for providing access management.

Characteristic	Potential Benefits	Potential Liabilities
Safety	Fewer access points generally result in a lower crash rate along a corridor. Physical segregation of opposing traffic flows if barrier or curb is used as an access management strategy.	Turn restrictions may require adding horizontal and vertical features to driveways, which may contribute to an increase in fixed object crashes.
Operations	Fewer access points generally result in an increase in LOS and capacity.	An increased number of U-turns at a signalized intersection due to access management may reduce the overall capacity of the intersection. An increase in weaving as vehicles entering the highway attempt to turn left at signalized intersections.
Multimodal	Fewer access points reduce the number of potential conflicts for bicycles and pedestrians.	Potential increases in operating speed along the arterial may negatively impact safety relative to bicycle and pedestrian modes.
Physical	None identified.	Turn restrictions may require adding horizontal and vertical features to driveways.
Socioeconomic	Socioeconomic benefits are mixed, with some studies reporting economic improvement and others reporting economic losses. Societal cost savings attributed to decreased crashes and travel delay.	Both economic improvement and economic losses have been reported.
Enforcement, Education, and Maintenance	None identified when raised channelization is used.	Periodic enforcement may be needed where signs are used instead of raised channelization. May be necessary to educate motorists on access options if corridor wide improvements are made, and provide emergency turnarounds for enforcement. Additional costs may be incurred for maintenance with the installation of physical barriers preventing access.

8.3 SIGNAL COORDINATION

8.3.1 Description

The primary objective of signal coordination is smooth flow of traffic along an arterial, street, or a highway to improve mobility, safety, and fuel consumption. This can be achieved by synchronizing the signal timings at multiple intersections along a major street to improve traffic flow in one or more directional movements. Examples include arterial streets, downtown networks, and closely spaced intersections like diamond interchanges. Intersections should be coordinated when they are in close proximity to each other (i.e., 0.5 miles or less) and there is a significant amount of traffic on the street being coordinated.⁽⁶⁶⁾ Coordination can also improve travel time reliability; reduce travel time, stops and delay; and improve air quality.⁽²⁰¹⁾

Coordination also has other benefits. Drivers may have occasional difficulty making permissive turns at signalized intersections because of lack of acceptable gaps in the opposing through traffic. This can contribute to both operational and safety problems. Providing coordination can create platooning of through traffic, resulting in availability of more acceptable gaps to left-turning traffic. Increasing acceptable gaps can improve intersection capacity and safety.

8.3.2 Applicability

Signal coordination may be applicable for intersections where:

- Lack of coordination is causing unexpected and/or unnecessary stopping of traffic approaching from adjacent intersections.
- Congestion between closely spaced intersections is causing queues from one intersection to interfere with the operation of another.
- Rear-end conflicts/collisions are occurring due to the higher probability of having to stop at each light.

8.3.3 Safety Performance

Apart from its operational benefits, signal coordination reduces vehicle conflicts along corridors with coordinated traffic signals. This reduces the number of rear-end conflicts, as vehicles tend to move more in unison from intersection to intersection.

Studies have proven the effectiveness of signal coordination in improving safety. The ITE *Traffic Safety Toolbox: A Primer on Traffic Safety* cites two studies of coordinated signals with intersection crash frequencies that dropped by 25 and 38 percent.⁽⁹⁸⁾ One study showed a decrease in crash rates for midblock sections as well. A study on the effectiveness of traffic signal coordination in Arizona concluded that there is a small but significant decrease in crash rates on intersection approaches after signal coordination.⁽⁹⁹⁾ Crashes along the study corridor decreased 6.7 percent. Another study of the safety benefits of signal coordination carried out in Phoenix compared coordinated signalized intersections to uncoordinated signalized intersections citywide. The coordinated intersections were found to have 3 to 18 percent fewer total collisions, and 14 to 43 percent fewer rear-end collisions.⁽¹⁰⁰⁾

Exhibit 8-14 shows selected findings of safety benefits associated with signal coordination.

Treatment	Finding
Signal Coordination ⁽¹⁰⁰⁾	3 to 18% estimated reduction in all collisions along corridor 14 to 43% estimated reduction in rear-end collisions along corridor
Provide Signal Progression ⁽¹⁰¹⁾	10 to 20% estimated reduction in all collisions along corridor

Exhibit 8-14. Selected findings of safety effects associated with signal coordination or progression.

8.3.4 Operational Performance

The potential benefits of coordination directly relate to the traffic characteristics and spacing of intersections. Coordinated operation works best when traffic arrives in dense platoons. These platoons occur more frequently when the intensity of traffic volume between intersections increases and distance between intersections decreases, to a practical limit. Selection of the system cycle length defines the relationship that allows coordinated operations between the intersections, while the offset represents the difference in start or end times for the through green at adjacent intersections.

The primary parameters to implement coordination are cycle lengths, splits, offsets and phasing sequences. Coordination requires a fixed background cycle length for all intersections within a specific coordination plan. Selection of an appropriate cycle length for a system is crucial for two reasons. First, the cycle length should be able to service the expected vehicle and pedestrian demand on all movements by selecting the appropriate split (time allocated to service each movement). Second, the cycle length should facilitate good progression along the major

street. Coordination is then achieved by adjusting the offsets (a function of start or end of a major street green with respect to the start or end of major street green for the adjacent intersection). These offsets are fine-tuned in the field to ensure that any residual queues are cleared before the arrival of platoons for smooth progression. Finally, progression can sometimes be further improved by modifying the signal phasing for left turns (e.g., implementing a lead-lag sequence).

A key to success in signal coordination is the appropriate spacing of the signals. Signals within a half-mile (or sometimes even more if platooning can be maintained) of each other should be coordinated. Dispersion of platoons can occur if signals are spaced too far apart, resulting in inefficient use of signal coordination and loss of any operational benefit. Operations on cross streets may be negatively impacted. The Colorado Access Demonstration Project concluded that 0.5-mi spacing could reduce vehicle hours of delay by 60 percent and vehicle-hours of travel by over 50 percent compared with signals at one-quarter mile intervals with full median openings between signals.^(90, adapted from reference¹⁰²)

Grouping the signals into a system to be coordinated is an important aspect of the design of a progressive system. Factors that should be considered include geographic barriers, v/c ratios, and characteristics of traffic flow (random versus platoon arrivals). When systems operating on different cycle lengths are adjacent to or intersect each other, changes to provide a uniform cycle length appropriate for both systems should be considered so that the systems can be unified, at least for certain portions of the day.

Coordination is effective in improving throughput along a major thoroughfare. However, during oversaturated conditions the objective typically changes from providing progression to managing queues. The traffic engineer needs to identify the period of oversaturated conditions and select the appropriate cycle length, splits, offsets, and phasing sequences to ensure smooth movement of traffic under such conditions by management of queues.

Dependent on the spacing between signalized intersections, prevalence of certain movements, or a disparity in ideal cycle lengths of each signalized intersection, it may be beneficial to consider half or double cycles, respective of other cycle lengths that appear on the corridor. Double cycles allow an intersection to cycle twice as frequently as a major intersection, while half cycles have half the cycle length of a major intersection along the corridor. According to FHWA's *Traffic Signal Timing Manual*,⁽⁶⁶⁾ half cycles can often produce substantially lower delays at the minor intersections where double cycling is employed. However, it may become more difficult to achieve progression in both directions along the major arterial, which may result in more arterial stops than desired.

8.3.5 Multimodal Impacts

Progression along a transit route can reduce travel time and improve travel time reliability of transit vehicles. The transit agency should also play a role. They can design their stops appropriately with respect to traffic signals to take advantage of the progression being provided along the corridor.

8.3.6 Physical Impacts

Signal coordination may require overhead or underground installation of wire, fiber, or radio equipment if direct connection type of coordination is employed.

8.3.7 Socioeconomic Impacts

Signal coordination will also reduce fuel consumption, noise, and air pollution, by reducing the number of stops and delays. If traffic signals are retimed and maintained properly, we would see a reduction in harmful emissions (carbon monoxide, nitrogen oxides, and volatile organic compounds) of up to 22 percent.⁽²⁰²⁾ According to the Surface Transportation Policy Project, motor vehicles are the largest source of urban air pollution.⁽²⁰³⁾ In addition, the EPA estimates that vehicles generate 3 billion pounds of air pollutants annually.⁽²⁰⁴⁾

8.3.8 Enforcement, Education, and Maintenance

Signals working in coordination should reduce excessive speed, as motorists realize that they cannot “beat” the next traffic signal. Incidents of aggressive driving should be reduced as well.

Signal timing plans need to be updated as traffic volumes and patterns change. This should be factored into periodic maintenance of the traffic signal.

8.3.9 Summary

Exhibit 8-15 summarizes the issues associated with providing signal coordination.

Characteristic	Potential Benefits	Potential Liabilities
Safety	Fewer rear-end and left-turn collisions.	May promote higher speeds.
Operations	Improves traffic flow.	Usually longer cycle lengths.
Multimodal	May reduce pedestrian-vehicle conflicts.	May result in longer pedestrian delays due to longer cycle lengths.
Physical	No physical needs.	None identified.
Socioeconomic	Reduces fuel consumption, noise, and air pollution.	None identified.
Enforcement, Education, and Maintenance	May result in less need for speed enforcement.	Signal timing plans need periodic updating.

Exhibit 8-15. Summary of issues for providing signal coordination.

8.4 SIGNAL PREEMPTION AND/OR PRIORITY

8.4.1 Description

Signal preemption and signal priority are terms describing treatments for special needs (e.g., drawbridge, railroad crossing), special vehicle classes or vehicles with multiple users, relative to automobile traffic at the intersection. Signal preemption is the higher order of the two treatments and involves transferring the intersection’s signal controller into a special operating mode designed to clear the intersection, if necessary, and then service the special vehicle type or need. The two most common types of signal preemption are emergency vehicle preemption and railroad preemption.

Priority is defined as the preferential treatment of one vehicle class (such as a transit vehicle, emergency service vehicle, or a commercial fleet vehicle) over another vehicle class at a signalized intersection without causing the traffic signal controllers to drop from coordinated operations. Priority may be accomplished by a number of methods, including changing the beginning and end times of greens on identified phases, changing the phase sequence, or including special phases, all without interrupting the general timing relationship between specific green indications at adjacent intersections.

8.4.2 Emergency Vehicle Preemption

A specific vehicle often targeted for signal preemption is the emergency vehicle. Signal preemption allows emergency vehicles to disrupt a normal signal cycle to proceed through the intersection more quickly and under safer conditions. The preemption systems can extend the green on an emergency vehicle’s approach or replace the phases and timing for the whole cycle. The MUTCD discusses signal preemption, standards for the phases during preemption, and priorities for different vehicle types that might have preemption capabilities.⁽¹⁾

Several types of emergency vehicle detection technologies are available. These include the use of light, sound, pavement loops, radio transmission, and push buttons to detect vehicles approaching an intersection:

- Light—an emitter mounted on emergency vehicles sends a strobe light toward a detector mounted at the traffic signal, which is wired into the signal controller.
- Sound—a microphone mounted at the intersection detects sirens on approaching vehicles; the emergency vehicles do not need any additional equipment to implement signal priority systems.
- Pavement loop—a standard pavement loop connected to an amplifier detects a signal from a low frequency transponder mounted on the emergency vehicle.
- Push button—a hardwire system is activated in the firehouse and is connected to the adjacent signal controller.
- Radio—a radio transmitter is mounted on the vehicle and a receiver is mounted at the intersection.

Many of these systems have applications in transit-vehicle priority as well as signal preemption for emergency vehicles. Some jurisdictions use signs that alert drivers of a police pursuit in progress.

8.4.3 Railroad Preemption

When located in close proximity to rail-highway grade crossings, signalized intersections can use railroad preemption to ensure that vehicles safely clear the crossing prior to train arrival. Operation of the grade crossing's active warning devices (flashing lights or flashing lights with gates) can be synchronized with the traffic signal display such that any active vehicular or pedestrian phases that conflict with the phase(s) servicing the intersection leg with the grade crossing are safely terminated, and then the phase(s) clearing vehicles from the grade crossing are activated with sufficient time to clear the crossing before train arrival.

The signal initiating railroad preemption originates from the track circuit and train detection equipment provided by the railroad for actively-controlled grade crossings. Variations exist in the design of the preemption interconnect circuit and track detection and warning system, but all share the purpose of providing adequate warning time of train arrival to both approaching motorists and the traffic signal controller. In special cases, advance preemption is used to alert the traffic signal controller about the impending arrival of a train before the grade crossing's active warning system (i.e., flashing lights with or without gates) begins operation. Proper design of signal timing for preemption operation is covered in the ITE *Preemption of Traffic Signals Near Railroad Crossings: An ITE Recommended Practice*.⁽²⁰⁵⁾

8.4.4 Transit Vehicle Priority

Unlike preemption, traffic signal priority operates within the context of a signal's routine operational mode. Also, while the immediacy of preemption requests allows the shortening of pedestrian walk and clearance intervals, these changes to routine signal operation are not allowed with signal priority. A variety of methods can be used to provide priority to buses or light rail vehicles, including extending green on identified phases, altering phase sequences and including special phases without interrupting the coordination of green lights between adjacent intersections.⁽⁶⁶⁾

Several different technologies are available for generating a priority request for the transit vehicle on approach to a signalized intersection. Pavement loops and radio (which can also be used for emergency vehicle preemption) can be employed in transit detection and signal interconnection, and even train detection circuits for light rail transit can be used. One emerging technology uses global positioning system (GPS) technology in accordance with the transit agency's automatic vehicle location (AVL) system to transmit a priority request signal in

conjunction with a roadside reader near the signal controller or remotely using the Internet and communication between the transit and road authority. Whether a priority request is granted and can be accommodated by the traffic signal controller can be affected by the current controller state and whether or not the transit vehicle is behind schedule at the time the priority request is received.

8.4.5 **Applicability**

Preemption/priority is considered where:

- Normal traffic operations impede a specific vehicle group (i.e., emergency vehicles).
- Traffic conditions create a potential for conflicts between a specific vehicle group and general traffic.

8.4.6 **Safety Performance**

No known research addresses the safety implications of emergency vehicle preemption, although it is expected that the number of conflicting movements associated with an emergency vehicle having to run a red light would be reduced.

Installation of signal preemption systems for emergency vehicles decreases response times. A review of signal preemption system deployments in the United States shows decreases in response times between 14 and 50 percent for systems in several cities. In addition, the study reports a 70 percent decrease in crashes with emergency vehicles in St. Paul, MN, after deploying the system.⁽¹⁰³⁾

Signal preemption has also been considered for intersections at the base of a steep and/or long grade. These grades create a potentially dangerous situation if large trucks lose control and enter the intersection at a high speed. Preemption can reduce the likelihood of conflicts between runaway trucks and other vehicles.

8.4.7 **Operational Performance**

Preemption of signals by emergency vehicles will temporarily disrupt traffic flow. Congestion may occur, or worsen, before traffic returns to normal operation. Data gathered on signal preemption systems in the Washington, DC, metropolitan area suggested that once a signal was preempted, the coordinated systems took anywhere between half a minute to 7 minutes to recover to base time coordination. During these peak periods in more congested areas, vehicles experienced significant delays. Agency traffic personnel indicated that signal preemption seems to have more impacts on peak period traffic in areas where the peak periods extend over longer time periods than it does where peak periods are relatively short.⁽¹⁰³⁾

8.4.8 **Multimodal Impacts**

Priority for transit vehicles can enhance transit operations, reducing delays and allowing for a tighter schedule, with minimal impacts to pedestrians and bicyclists. A study in King County, Washington showed that transit signal priority coupled with signal timing optimization resulted in a 40 percent reduction in transit signal delay and a 35 to 40 percent reduction in travel time variability. In Portland, Oregon, transit signal priority improved travel time by 10 percent and reduced travel time variability by 19 percent.⁽²⁰⁶⁾

8.4.9 **Physical Impacts**

The key to success is ensuring that the preemption system works when needed by providing clear sight lines between emergency vehicles and detectors. Also, practitioners should ensure that vehicles from a variety of jurisdictions can participate in the signal preemption program.

Light-based detectors need a clear line of sight to the emitter on the vehicles; this line could become blocked by roadway geometry, vehicles, foliage, or precipitation. Also, systems from

different vendors may not interact well together. Other alarms, such as from nearby buildings, may be detected by a sound-based system.

8.4.10 Socioeconomic Impacts

Reduction in response time by emergency services and more predictable transit services benefit society. However, the costs, particularly when applied to an entire road network, can be significant.

8.4.11 Enforcement, Education, and Maintenance

Preemption directly benefits emergency vehicles, although most police agencies do not use signal preemption. Preempted signals that stop vehicles for too long may encourage disrespect for the red signal, although this has not been reported.

8.4.12 Summary

Exhibit 8-16 summarizes the issues associated with providing signal preemption and/or priority.

Characteristic	Potential Benefits	Potential Liabilities
Safety	Quicker response time for emergency vehicles. On steep grades, preemption could be used to minimize conflicts between runaway trucks and other vehicles.	None identified.
Operations	None identified.	Can be disruptive to traffic flow, particularly during peak hours.
Multimodal	Delay to transit vehicles and travel time variability is reduced.	None identified.
Physical	None identified.	Requires a clear line of sight between the emergency vehicle and the transmitter; other nearby radio systems may be affected or interfere.
Socioeconomic	Lower emergency service response time. More reliable transit service.	Can be costly.
Enforcement, Education, and Maintenance	Improves emergency vehicle response time.	None identified.

Exhibit 8-16. Summary of issues for providing signal preemption and/or priority.

CHAPTER 9

INTERSECTION-WIDE TREATMENTS

TABLE OF CONTENTS

9.0	INTERSECTION-WIDE TREATMENTS	9-3
9.1	Pedestrian Treatments.....	9-3
9.1.1	Reduce Curb Radius.....	9-4
9.1.2	Provide Curb Extensions	9-6
9.1.3	Modify Stop Line Location.....	9-8
9.1.4	Improve Pedestrian Signal Displays	9-10
9.1.5	Modify Pedestrian Signal Phasing	9-13
9.1.6	Grade-Separate Pedestrian Movements	9-15
9.1.7	High Visibility Crosswalks	9-17
9.2	Bicycle Treatments.....	9-18
9.2.1	Provide Bicycle Box	9-18
9.2.2	Provide Bike Lanes	9-19
9.3	Transit Treatments	9-21
9.3.1	Relocate Transit Stop	9-21
9.4	Traffic Control Treatments	9-23
9.4.1	Change Signal Control from Pre-Timed to Actuated	9-23
9.4.2	Modify Change and Clearance Intervals (Yellow and All-Red).....	9-26
9.4.3	Modify Cycle Length	9-29
9.4.4	Late Night/Early Morning Flash Removal	9-30
9.5	Street Lighting and Illumination.....	9-32
9.5.1	Provide or Upgrade Illumination.....	9-32
9.6	Remove Traffic Signal.....	9-35
9.6.1	Convert Signalized Intersection to a Roundabout	9-35
9.6.2	Convert Signalized Intersection to All-Way Stop Control	9-37

LIST OF EXHIBITS

9-1	A curb radius increase from 15 ft to 50 ft increases the pedestrian crossing distance from 62 ft to 100 ft, all else being equal	9-4
9-2	Summary of issues for curb radius reduction	9-6
9-3	Intersection with curb extension in South Haven, Michigan	9-7
9-4	Summary of issues for curb extensions.....	9-8
9-5	Benefits of Modifying Stop Line Location	9-9

9-6	Summary of issues for stop line alterations	9-10
9-7	Examples of countdown and animated eyes pedestrian signal displays.....	9-11
9-8	Safety effects associated with addition of pedestrian signals: selected findings	9-12
9-9	Summary of issues for pedestrian signal display improvements.....	9-12
9-10	Summary of issues for pedestrian signal phasing modifications	9-15
9-11	Summary of issues for pedestrian grade separation	9-17
9-12	Summary of issues for high visibility crosswalks	9-18
9-13	Summary of issues for providing a bicycle box	9-19
9-14	Summary of issues for providing bicycle lanes.....	9-20
9-15	Summary of issues for near-side/far-side transit stops	9-23
9-16	Summary of issues for providing signal actuation	9-25
9-17	Safety effects associated with modifying clearance intervals: selected findings.....	9-27
9-18	Summary of issues for modifying yellow/red clearance intervals	9-28
9-19	Summary of issues for cycle length modifications.....	9-30
9-20	Safety effects associated with removal of signal from late night/early morning flash mode: selected findings	9-31
9-21	Summary of issues for flash mode removal	9-31
9-22	Safety effects associated with providing illumination: Selected findings	9-33
9-23	Summary of issues for providing illumination	9-34
9-24	Safety effects associated with converting traffic signals to roundabouts: selected findings	9-35
9-25	Summary of issues for converting traffic signals to roundabouts	9-37
9-26	Safety effects associated with converting traffic signals to multi-way stop	9-37
9-27	Summary of issues for converting traffic signals to all-way stop control	9-38

9.0 INTERSECTION-WIDE TREATMENTS

This chapter discusses five groups of intersection-wide treatments:

- Pedestrian treatments.
- Bicycle treatments.
- Transit treatments.
- Traffic control treatments.
- Illumination.

9.1 PEDESTRIAN TREATMENTS

Accommodating pedestrians significantly affects the design and operations of a signalized intersection and should therefore be an integral part of the design process. Key actions to consider are:

- Protect crossing locations with a high number of pedestrians (where possible) from conflicting through traffic.
- Minimize crossing distances.
- Provide adequate crossing times.
- Locate pedestrian ramps within the crosswalk.
- Ensure pedestrian ramp location and design meet ADA requirements.
- Consider high visibility cross walk markings.

One common way to better accommodate pedestrians and improve their safety is to reduce their crossing distance. Reducing crossing distance decreases a pedestrian's exposure to traffic, which may be particularly helpful to pedestrians who are disabled or elderly. It also reduces the amount of time needed for the pedestrian phase, which reduces the delay for all other vehicular and pedestrian movements at the intersection. Three common methods of reducing pedestrian crossing distance are:

- Reducing curb radius
- Extending curbs.
- Providing median crossing islands.

Traffic engineers have also modified the location of the stop line and crosswalk to try to control where motorists stop on the intersection approach and where pedestrians cross.

Traffic control improvements directly applicable to pedestrians include:

- Improving the signal display to the pedestrian through the use of redundancy, including the use of pedestrian signals, accessible pedestrian signals, and enhancements to the pedestrian signal display.
- Modifying the pedestrian signal phasing.

Each of these treatments is discussed in the following sections; median crossing islands were addressed in Chapter 8.

9.1.1 Reduce Curb Radius

Description

A wide curb radius typically results in high-speed turning movements by motorists, increasing the opportunity for right-turning vehicle conflicts with pedestrians. Existing guidelines recommend reconstructing the turning radius to a tighter turn to reduce turning speeds, shorten the crossing distance for pedestrians, and improve sight distance between pedestrians and motorists. Exhibit 9-1 demonstrates that increasing the curb radius increases pedestrian crossing distance. Tighter turning radii are even more important where street intersections are not at right angles.⁽¹⁰⁴⁾

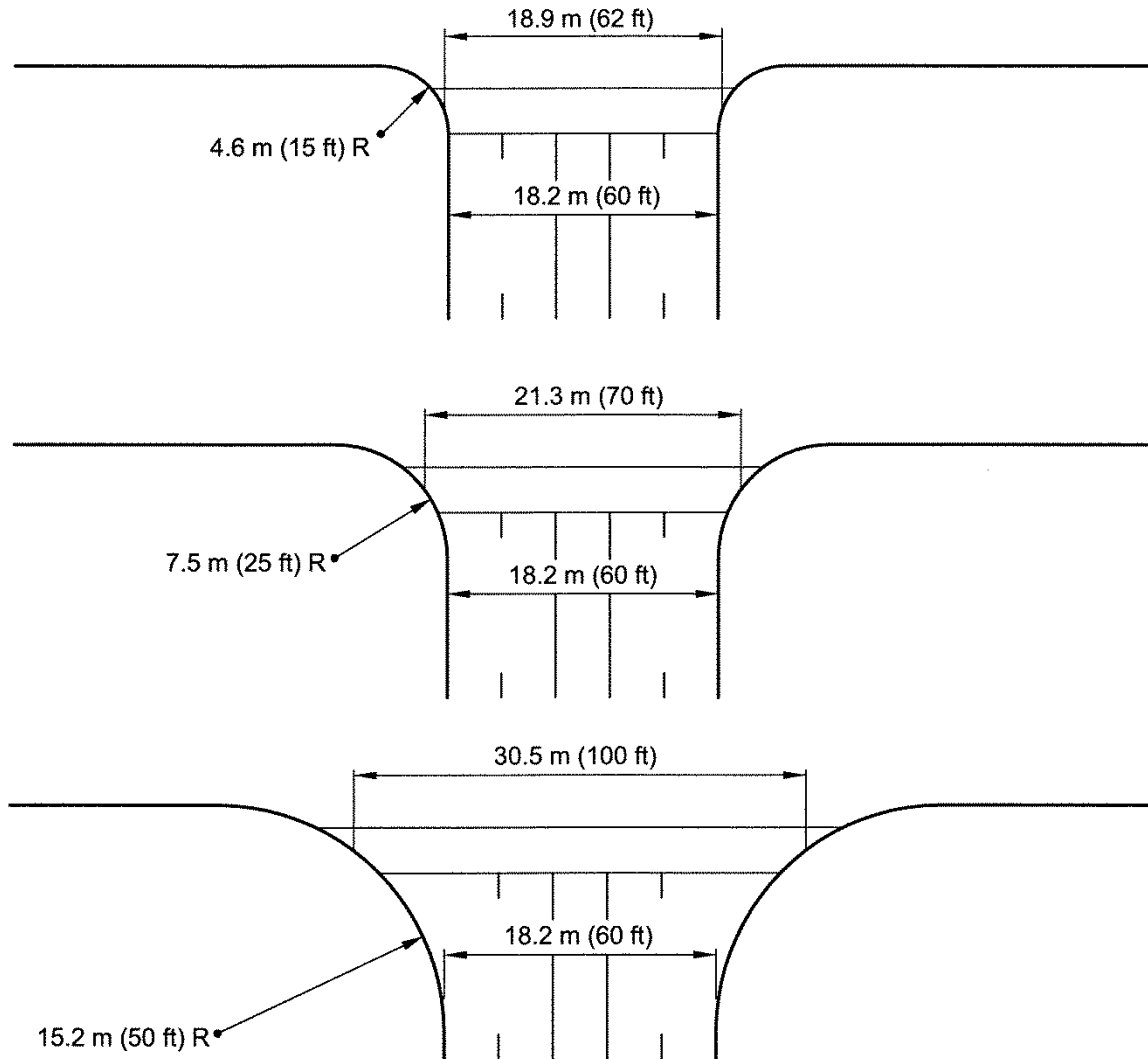

Exhibit 9-1. A curb radius increase from 15 ft to 50 ft increases the pedestrian crossing distance from 62 ft to 100 ft, all else being equal.

Applicability

Consider reducing the curb radii at any signalized intersection with pedestrian activity. Note that the need to accommodate the design vehicle may limit how much the curb radius can be reduced.

Safety Performance

Reducing the curb radius lowers the speed of right-turning vehicles and should reduce the frequency of pedestrian-vehicle collisions. Any remaining collisions will be less severe due to the lower speeds involved. Crash severity increases significantly between 20 and 40 mph.⁽¹⁰⁵⁾

However, vehicles turning right will be forced to decelerate more rapidly in attempting the right turn. This could lead to rear-end conflicts with through vehicles, particularly if a separate right-turn lane is not provided and the through movements have high speeds.

Operational Performance

Reducing pedestrian crossing distance via smaller curb radii reduces the amount of time needed to serve the pedestrian clearance time. This may result in shorter cycle lengths and less delay for all users. However, a curb radius reduction may reduce the capacity of the affected right-turn movement.

Multimodal Impacts

Pedestrians benefit from a shorter crossing distance and the reduced speed of right-turning vehicles.

Larger vehicles and transit may have difficulty negotiating the tighter corner, either swinging out too far into the intersection or having their rear wheels encroach the curb onto the sidewalk. Caution should be exercised in reducing curb radius if right-turning large trucks or buses are frequent users. It may be necessary to move the stop line locations on the roadway the trucks are turning into to allow them to briefly swing wide into the opposing lanes.

Physical Impacts

Reducing the curb radius reduces the size of the intersection and allows for additional space for landscaping or pedestrian treatments. Traffic signal equipment may need to be relocated.

Socioeconomic Impacts

Depending on the degree of improvement, low to moderate construction costs will be associated with the reconstruction of the curb radius.

Enforcement, Education, and Maintenance

The effectiveness of this treatment may be enhanced by police enforcement of drivers failing to come to a complete stop on a red signal when making a right turn and/or not yielding to pedestrians in the crosswalk.

Summary

Exhibit 9-2 summarizes issues associated with curb radius reduction.

Exhibit 9-2. Summary of issues for curb radius reduction.

Characteristic	Potential Benefits	Potential Concerns
Safety	Reduction in right-turning vehicle/pedestrian collisions. Fewer right-turn-on-red violations.	May increase right-turning/through vehicle rear-end collisions due to increased speed differential. Large vehicle off-tracking.
Operations	Less overall delay due to reduced time needed to serve pedestrian movement.	Reduction in capacity for affected right-turn movement.
Multimodal	Shorter crossing distance. Facilitates the use of two perpendicular ramps rather than a single diagonal ramp.	May be more difficult for large trucks and buses to turn right.
Physical	Reduces the size of the intersection.	None identified.
Socioeconomic	Low to moderate costs.	None identified.
Enforcement, Education, and Maintenance	None identified.	Enforcement of yielding to pedestrians may be necessary.

9.1.2 Provide Curb Extensions

Description

Curb extensions, also known as “bulbouts” or “neckdowns,” involve extending the sidewalk or curb line into the street, reducing the effective street width. These are often used for traffic calming on neighborhood streets, but the technique is applicable for higher volume signalized intersections. Curb extensions improve the visibility of the pedestrian crosswalk. They reduce the amount of roadway available for illegal or aggressive motorist activities such as failing to yield to pedestrians, making high-speed turns, and passing in the parking lane. It has also been observed that motorists are more inclined to stop behind the crosswalk at a curb extension, and that pedestrians are more inclined to wait on the curb extension than in the street. An example of a curb extension is shown in Exhibit 9-3.

Curb extensions provide multiple benefits:

- Improve crosswalk visibility
- Reduce pavement for high-speed turns and passing on right.
- Motorists are more likely to stop.
- Pedestrians are more likely to wait.

Application

This treatment applies to urban intersections with moderate to heavy pedestrian traffic and/or a history of pedestrian collisions. It would not be appropriate at high-speed rural intersections, and caution should be used at intersections with a high proportion of right-turning movements. Curb extensions can be used to terminate parking lanes; care should be exercised if they are used to terminate travel lanes.



Exhibit 9-3. Intersection with curb extension in South Haven, Michigan.
Photo credit: Jeff Shaw, Federal Highway Administration

Safety Performance

Reducing the pedestrian crossing distance and subsequent exposure of pedestrians to traffic should reduce the frequency of pedestrian collisions. A New York City study suggested that curb extensions appear to be associated with lower frequencies and severities of pedestrian collisions.⁽¹⁰⁶⁾ Curb extensions should also reduce speeds on approaches where they are applied.

Operational Performance

The operational performance effects of curb extensions are similar to those for reduced curb radii. The reduction in pedestrian crossing distance reduces the amount of time needed to serve the pedestrian clearance time. This may result in shorter cycle lengths and less delay for all movements. However, the reduced curb radius resulting from the curb extension may reduce the capacity of the affected right-turn movement. If a right-turn lane is present, the curb radius reduction should not impede through movements.

Because curb extensions are essentially a traffic-calming treatment, they will likely reduce speeds and possibly divert traffic to other roads; right-turn movements would be particularly affected by this treatment. Emergency services (fire, ambulance, and police) should be consulted if this treatment is being considered.

Multimodal Impacts

Pedestrians benefit greatly from the provision of curb extensions. The curb extension can greatly improve the visibility between pedestrians and drivers. In addition, the reduction in pedestrian crossing distance reduces pedestrian exposure and crossing time.

Bicycle movements and interactions with motor vehicles need to be considered in the design of any curb extensions.

Practitioners should use caution when considering this treatment along heavy truck routes. All types of trucks and transit vehicles, in particular those needing to turn right at the intersection, would be negatively affected by this treatment.

Physical Impacts

Drainage should be evaluated whenever curb extensions are being considered, as the curb extension may interrupt the existing flow line.

Socioeconomic Impacts

Costs associated with this improvement would be low to moderate.

Enforcement, Education, and Maintenance

No specific effects have been identified.

Summary

Exhibit 9-4 provides a summary of the issues associated with curb extensions.

Characteristic	Potential Benefits	Potential Concerns
Safety	Reduction in right-turning vehicle/pedestrian collisions. Fewer right-turn-on-red violations.	May increase right-turning/through vehicle rear-end collisions due to increased speed differential. Large vehicle off-tracking.
Operations	Less overall delay due to reduction in time needed to serve pedestrian movement.	May adversely affect operation if curb extension replaces a travel lane. Right-turn movements delayed. Emergency vehicles may be significantly delayed.
Multimodal	Shorter crossing distance. Facilitates the use of two perpendicular ramps rather than a single diagonal ramp. Better visibility between pedestrians and drivers.	May be more difficult for large trucks and buses to turn right.
Physical	None identified.	Drainage may be adversely affected.
Socioeconomic	Low to moderate costs.	None identified.
Enforcement, Education, and Maintenance	None identified.	None identified.

Exhibit 9-4. Summary of issues for curb extensions.

9.1.3 Modify Stop Line Location

Description

Visibility is a key consideration for determining the location of stop lines. The FHWA *Pedestrian Facilities Users Guide—Providing Safety and Mobility* suggests advance stop lines as a possible countermeasure.⁽³⁸⁾ At signalized pedestrian crossing locations, the vehicle stop line can be moved 15 to 30 ft further back from the pedestrian crossing than the standard 4 ft distance to improve visibility of through bicyclists and crossing pedestrians for motorists (and particularly truck drivers) who are turning right. Advanced stop lines benefit pedestrians, as the pedestrians and drivers have a clearer view and more time to assess each other's intentions when the signal phase changes, as shown in Exhibit 9-5.

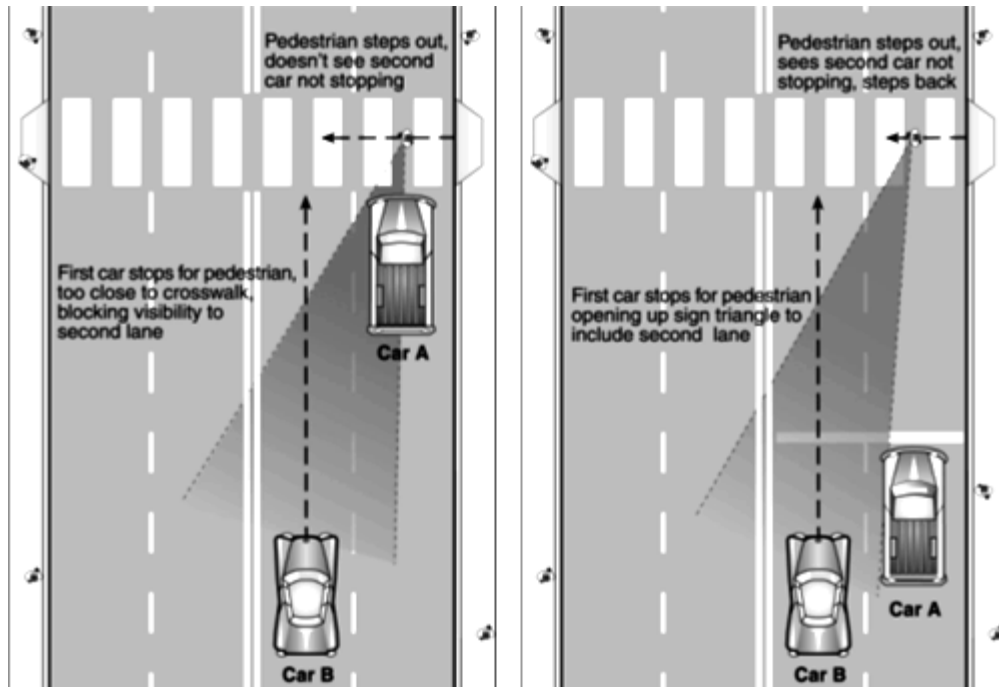

Exhibit 9-5. Benefits of Modifying Stop Line Location

Source: *Crossing Enhancements*, Pedestrian and Bicycle Information Center, www.walkinfo.org.

Applicability

Relocated stop lines may apply to intersections with frequent conflicts between pedestrians and adjacent right-turning vehicles, or a history of right-turn-on-red vehicle/pedestrian collisions.

Safety Performance

One evaluation study found that advance stop lines resulted in reduced right-turn-on-red conflicts with cross traffic; more right-turn-on-red vehicles also made complete stops behind the stop line. Another study determined that stop line relocation resulted in better driver compliance with the new location and increased elapsed time for lead vehicles entering the intersection. This may decrease the risk of pedestrian collisions involving left-turning vehicles^{(104),(108),(109)} However, placing the crosswalk at least 10 ft or more from the cross-street flow line or curb also provides more time for drivers to react for the presence of pedestrian crossing on the street they are about to enter.⁽¹¹⁰⁾

Operational Performance

Advance stop lines increase the clearance time for vehicles passing through the intersection. As a result, there may be an increase in lost time. If in-pavement stop line vehicle detectors are already installed at this signalized intersection, they may need to be replaced or modified.

Multimodal Impacts

Advance stop lines can better allow trucks entering the intersection from the side street to turn wide, thereby allowing smaller curb radii that are more pedestrian friendly.

Physical Impacts

No physical needs have been identified.

Socioeconomic Impacts

Minimal costs associated with stop line alterations.

Enforcement, Education, and Maintenance

Supplemental signing (e.g., STOP HERE with appropriately oriented downward pointing arrow) and enforcement of the relocated stop lines may be necessary.

Summary

Exhibit 9-6 summarizes the issues associated with stop line alterations.

Characteristic	Potential Benefits	Potential Concerns
Safety	Decreased risk of pedestrian collisions.	None identified.
Operations	None identified.	Increase in vehicular clearance time and lost time.
Multimodal	Facilitates turning movements of heavy trucks.	None identified.
Physical	No physical needs identified.	None identified.
Socioeconomic	None identified.	None identified.
Enforcement, Education, and Maintenance	Improved compliance.	None identified.

Exhibit 9-6. Summary of issues for stop line alterations.

9.1.4 Improve Pedestrian Signal Displays

Traffic signals should allow adequate crossing time for pedestrians and an adequate change and clearance interval based on walking speed. Pedestrian signal enhancements include:

- Separate pedestrian signals (WALK/DON'T WALK)
- Accessible pedestrian signals.
- Countdown displays.
- Animated eyes display.

Application

Chapter 5 provided guidance on the use of pedestrian signals and accessible pedestrian signals. Current thinking suggests that redundancy in information benefits all pedestrians. For example, sighted pedestrians may react more quickly to the WALK indication when provided an audible cue in addition to the pedestrian signal display. Therefore, accessible pedestrian signals may enhance the usability of the intersection for all pedestrians, not just those with visual impairments.

Countdown signals, shown in Exhibit 9-7(a), display the number of seconds remaining before the end of the flashing DON'T WALK interval. The WALKING PERSON symbol and flashing and steady UPRAISED HAND symbol still appear at the appropriate intervals. The countdown signals do not change the way a signal operates; they only provide additional information to the pedestrian. All pedestrian signal heads used at crosswalks where the pedestrian change interval is more than 7 seconds shall include a pedestrian change interval countdown display in order to inform pedestrians of the number of seconds remaining in the pedestrian change interval.⁽¹⁾

Another innovative pedestrian signal treatment is an animated eyes display, shown in Exhibit 9-7(b). The animated, LED signal head is used to prompt pedestrians to look for turning vehicles at the start of the WALK indication. The signal head includes two eyes that scan from left to right.

Animated eyes are included in the MUTCD for optional use with the pedestrian signal WALK indication.⁽¹⁾



(a) Countdown display.⁽¹¹¹⁾



(b) Animated eyes display.

Exhibit 9-7. Examples of countdown and animated eyes pedestrian signal displays.

Safety Performance

The available research does not provide a clear indication of the safety effects of installing pedestrian signals. One report suggests that installing pedestrian signals is associated with a 15 to 17 percent reduction in pedestrian collisions.⁽¹¹²⁾ However, a number of older studies found that pedestrian signalization does not improve safety.^{(113),(114)} Larger pedestrian signal heads were described in the literature as a treatment to enhance conspicuity, though no research on the effect on pedestrian safety was found.

Accessible pedestrian signals assist visually impaired pedestrians. Different devices generating audible messages (audible at pedestrian head or audible at push button), vibration at push button, and transmitted messages are in use.⁽¹¹⁵⁾ A recent study found a 75 percent reduction in the percentage of pedestrians not looking for threats and a similar reduction in conflicts at an intersection equipped with speakers providing messages prompting pedestrians to look for turning vehicles during the walk interval.⁽¹¹⁶⁾

Countdown displays may reduce vehicle-pedestrian conflicts resulting from pedestrians attempting to cross the intersection at inappropriate times. Some studies of these pedestrian countdown signals found no statistically significant reductions in pedestrian crash rates. The countdowns did result in a higher percentage of successful crossings by pedestrians (completed their crossing before conflicting traffic received the right-of-way).^{(110),(117),(118)} A 2005 study in San Francisco, California, indicated a reduction of up to 52 percent by converting to countdown signals.⁽¹¹⁹⁾

Results from studies of the use of animated-eye displays show increased pedestrian observation of traffic behavior and reductions in pedestrian/vehicle conflicts at a variety of intersection configurations.^{(116),(120)} The 2009 MUTCD allows for and provides a standard for its design (Section 4E.04).

Exhibit 9-8 presents the results of selected references involving the addition of pedestrian signals.

Treatment	Implication
Convert WALK / DON'T WALK pedestrian signals to countdown signals	52% reduction in pedestrian-related crashes.

Exhibit 9-8. Safety effects associated with addition of pedestrian signals: selected findings.⁽¹⁴⁷⁾

Operational Performance

These treatments should have a negligible effect on vehicle operations. Redundant visual and audible displays may reduce the delay pedestrians experience in initiating their crossing, which may reduce the delay for right-turning vehicles.

Multimodal Impacts

Some treatments described above are of specific benefit to people with visual disabilities, although all pedestrians are likely to benefit from redundancy. They should be considered when modifying intersections.

Apart from pedestrians, there are no specific impacts to other transportation modes.

Physical Impacts

No particular specific physical needs have been identified.

Socioeconomic Impacts

Pedestrian signals and the pedestrian signal enhancements described above have moderate costs.

Enforcement, Education, and Maintenance

As some of the treatments described above have not seen widespread use (e.g., the animated eyes display), some education on the meaning of the devices should be considered upon their introduction to the public.

Summary

Exhibit 9-9 summarizes the issues associated with pedestrian signal display improvements.

Characteristic	Potential Benefits	Potential Concerns
Safety	Give pedestrians improved awareness of traffic.	None identified.
Operations	None identified.	None identified.
Multimodal	All pedestrians, but especially visually impaired pedestrians, are likely to benefit.	None identified.
Physical	None identified.	None identified.
Socioeconomic	None identified.	Some enhancements are expensive.
Enforcement, Education, and Maintenance	None identified.	Education may be necessary.

Exhibit 9-9. Summary of issues for pedestrian signal display improvements.

9.1.5 Modify Pedestrian Signal Phasing

Description

In general, shorter cycle lengths and longer WALK intervals provide better service to pedestrians and encourage greater signal compliance. Pedestrian walking speeds generally range between 2.5 to 6.0 ft/s.⁽³⁾ The MUTCD uses a walk speed of 3.5 ft/s for determining crossing times (Page 497, Sect. 4E.06-07).⁽¹⁾ However, FHWA pedestrian design guidance recommends a lower speed to accommodate users who require additional time to cross the roadway, and in particular a lower speed in areas where there are concentrations of children and or elderly persons.^{(37),(38)} The *HCM 2000* indicates that if elderly persons constitute more than 20 percent of the total pedestrians, the average walking speed should be decreased to 3.0 ft/s.⁽²⁾

Three options beyond standard pedestrian signal phasing are:

- The leading pedestrian interval.
- The lagging pedestrian interval.
- The exclusive pedestrian phase.

A leading pedestrian interval entails retiming the signal splits so that the pedestrian WALK signal begins a few seconds before the vehicular green. While the vehicle signals are in “All Red,” this allows pedestrians to establish their presence in the crosswalk before the turning vehicles, thereby enhancing the pedestrian right-of-way.

A lagging pedestrian interval entails retiming the signal splits so that the pedestrian WALK signal begins a few seconds after the vehicular green for turning movement. The 2001 ITE guide, *Alternative Treatments for At-Grade Pedestrian Crossings*, indicates that this treatment is applicable at locations where there is a high one-way to one-way turning movement and works best where there is a dedicated right-turn lane.⁽¹¹⁰⁾ This benefits right-turning vehicles over pedestrians by giving the right turners a head start before the parallel crosswalk becomes blocked by a heavy and continuous flow of pedestrians.

An exclusive pedestrian signal phase allows pedestrians to cross in all directions at an intersection at the same time, including diagonally. It is sometimes called a “Barnes dance” or “pedestrian scramble.” Vehicle signals are red on all approaches of the intersection during the exclusive pedestrian signal phase. The objective of this treatment is to reduce vehicle turning conflicts, decrease walking distance, and make intersections more pedestrian-friendly. The 2001 ITE guide refers to research that indicates that leading intervals were more effective treatments than this scramble pattern.⁽¹¹⁰⁾

Application

Leading pedestrian phasing may be considered where:

- There is moderate to heavy pedestrian traffic.
- A high number of conflicts/collisions occur between turning vehicles and crossing pedestrians.

Lagging pedestrian phasing may be considered where:

- There is moderate to heavy pedestrian traffic.
- There is right-turn channelization that is heavily used by vehicles.
- A high number of conflicts/collisions occur between right-turning vehicles and crossing pedestrians.

Exclusive pedestrian phasing (scramble) may be considered where:

- There is heavy pedestrian traffic.
- Delay for vehicular turning traffic is excessive due to the heavy pedestrian traffic.
- There are a large number of vehicle-pedestrian conflicts involving all movements.

Note that for any of the three treatments, practitioners should use accessible pedestrian signals to give people with visual disabilities information regarding the walk phase in the absence of predictable surging traffic.

Safety Performance

Several studies have demonstrated that imposing leading pedestrian intervals significantly reduces conflicts for pedestrians.^{(106),(110),(121)} Crash analysis conducted at 26 locations with leading pedestrian intervals in New York City (based on up to 10 years of data) showed that leading pedestrian intervals have a positive effect on pedestrian safety, especially where there is a heavy concentration of turning vehicles. This evidently occurs regardless of pedestrian volume.

None of the studies of lagging pedestrian intervals considered the safety effect of this treatment.

Using exclusive pedestrian intervals that stop traffic in all directions has been shown to reduce pedestrian crashes by 50 percent in some locations (i.e., downtown locations with heavy pedestrian volumes and low vehicle speeds and volumes).^{(104),(122)}

Operational Performance

The leading pedestrian phase will increase delay at the intersection due to a loss in green time. A solution for the issue of loss of green time for vehicles when using a leading pedestrian interval is based on trading the leading pedestrian interval seconds at the beginning of the cycle for seconds at the end of the cycle. This causes all movements to receive less green time, but optimizes that time. However, this timing was not investigated empirically.⁽¹⁰⁶⁾

A main operational disadvantage of lagging pedestrian intervals is additional delays to pedestrians.

With concurrent signals, as described above, pedestrians usually have more crossing opportunities and shorter waits. Unless a system more heavily penalizes motorists, pedestrians will often have to wait a long time for an exclusive pedestrian phase. As a result, many pedestrians will simply choose to ignore the signal and cross if and when a gap in traffic occurs.^{(104),(122)} In addition, an exclusive pedestrian phase may increase the overall cycle length of the intersection, thus increasing delay for all users. On the other hand, an exclusive pedestrian phase removes pedestrians from the vehicular phases, thus increasing vehicular capacity during those phases.

Multimodal Impacts

Pedestrians may become impatient or ignore a lagging pedestrian interval or exclusive pedestrian phase and begin crossing the road during the DON'T WALK phase.

Physical Impacts

No specific physical needs were identified.

Socioeconomic Impacts

Minimal costs are associated with the retiming of the pedestrian signals. The exclusive pedestrian phase, if implemented, may require additional signing and pavement markings to indicate that diagonal crossings may be made (2009 MUTCD, Section 3B.18).⁽¹⁾

Enforcement, Education, and Maintenance

Leading or lagging pedestrian phases should be accompanied by police enforcement to ensure that vehicles and pedestrians obey traffic signals.

Summary

Exhibit 9-10 summarizes the issues associated with pedestrian signal phasing modifications.

Characteristic	Potential Benefits	Potential Concerns
Safety	Reduce pedestrian/vehicle collisions.	None identified.
Operations	Exclusive phase: increased capacity for vehicular turning movements.	Lead phase: increased vehicular delay. Exclusive phase: increased vehicular delay due to potentially longer cycle length.
Multimodal	Lead phase: reduced pedestrian delay.	Lag phase: increased pedestrian delay. Exclusive phase: increased pedestrian delay due to potentially longer cycle length.
Physical	None identified.	None identified.
Socioeconomic	Lead or lag phases: little or no cost.	Exclusive phase: low cost to implement; moderate costs associated with vehicle delays.
Enforcement, Education, and Maintenance	None identified.	Enforcement may be necessary.

Exhibit 9-10. Summary of issues for pedestrian signal phasing modifications.

9.1.6 Grade-Separated Pedestrian Treatment

Description

In some situations, it may be feasible to separate pedestrian movements from an intersection. Pedestrian overpasses and underpasses allow for the uninterrupted flow of pedestrian movement separate from the vehicle traffic. However, it increases out-of-direction travel, both horizontally and vertically, for the pedestrian in the process.

Applicability

Pedestrian grade separation may be appropriate in situations where:

- An extremely high number of pedestrian/vehicle conflicts or collisions are occurring at the existing crossing location.
- School crossings exist or high volumes of children cross.
- A crossing has been evaluated as a high-risk location for pedestrians.
- Turning vehicles operate with high speeds.
- Sight distance is inadequate.

Usually, a warrant for a grade pedestrian separation is based on pedestrian and vehicle volume, vehicle speed, and area type. Warrants usually differ for new construction projects and existing highways. The first case provides greater opportunities for grade separation. In some cases, safety can be a major factor; for example, New Jersey Department of Transportation guidelines consider pedestrian overpasses and/or underpasses warranted if a safety evaluation indicates that erection of a fence to prohibit pedestrian crossing.⁽¹²³⁾

Safety Performance

Ideally, pedestrian grade separations should completely remove any pedestrian/vehicle conflicts at the location in question. However, studies have shown that many pedestrians will not use overpasses or underpasses if they can cross at street level in about the same amount of time, or if the crossing takes them out of their way. Some pedestrians may avoid a pedestrian tunnel or overpass due to personal security concerns.

Operational Performance

Completely eliminating a pedestrian crossing area should improve traffic flow. However, a pedestrian overpass will not likely be used if it is too inconvenient. Use of a median pedestrian barrier or landscaping treatments should be considered to reduce midblock crossings and encourage pedestrians to use the grade-separated crossing.

Multimodal Impacts

Pedestrian access and convenience may be negatively affected by grade separation. Pedestrians with disabilities or low stamina may have difficulty with the out-of-direction travel and elevation changes associated with grade separation.

Physical Impacts

Construction of a bridge overpass or tunnel is required. Note that any new or modified pedestrian grade separation treatment must comply with ADA requirements. This may involve adding long ramps with landings at regular intervals or installing elevators.

Socioeconomic Impacts

Grade separation can be very expensive and difficult to implement. As a result, grade separation is usually only feasible where pedestrians must cross high-speed, high-volume arterials.⁽¹⁰⁴⁾ In most cases, other treatments are likely to be more cost effective.

Enforcement, Education, and Maintenance

Maintenance issues associated with litter and graffiti are significant with pedestrian overpasses and underpasses. Additional police enforcement may be needed because of the fear of crime in these facilities.

Summary

Exhibit 9-11 summarizes the issues associated with pedestrian grade separation.

Characteristic	Potential Benefits	Potential Concerns
Safety	Reduced pedestrian-vehicle collisions. Converting at-grade intersections to grade-separated interchanges is associated with a 57 percent reduction in injury crashes, although this finding is for all road users. ⁽¹²⁴⁾	Pedestrians may cross in unexpected locations due to inconvenience of grade separation.
Operations	Improved vehicular capacity.	None identified.
Multimodal	Fewer conflicts between pedestrians and vehicles.	Increased walking distance, delay, and difficulty for pedestrians.
Physical	None identified.	Grade separation structure required, as well as ramps or elevators to meet ADA requirements.
Socioeconomic	None identified.	Significant costs (grade separation).
Enforcement, Education, and Maintenance	None identified.	Graffiti removal and enforcement for personal security may be necessary.

Exhibit 9-11. Summary of issues for pedestrian grade separation.

9.1.7 High Visibility Crosswalks

Description

In some situations, increasing the conspicuity of crosswalks can provide a safety benefit to pedestrians at signalized intersections. Designs and product application vary around the country based on State and local needs. The crosswalk should include retroreflective pavement markings (versus only using a different material like brick for the crosswalk).

Applicability

The addition of high visibility crosswalks may apply to intersections with frequent conflicts between pedestrians and vehicles. Due to the low cost of this treatment, it could also serve as a systemic treatment on a series of intersections or jurisdiction-wide as a policy.

Safety Performance

Anecdotal evidence has shown a safety benefit to the installation of high visibility crosswalks. A case study in New York City in 1995 indicated reductions at a small number of installations at locations with a high number of pedestrian-vehicle crashes.

Additionally, a ladder-style, also referred to as a continental style, crosswalk (longitudinal versus lateral) was shown to be effective for keeping vehicles out of the crosswalk area.⁽¹²⁵⁾

Operational Performance

None identified. The high visibility crosswalks typically have the same footprint as existing crosswalks.

Multimodal Impacts

High visibility crosswalks provide an enhanced space for pedestrian and bicycles to cross the intersection safely.

Physical Impacts

None identified. High visibility crosswalks typically have the same footprint as existing crosswalks.

Socioeconomic Impacts

Minimal costs are associated with high visibility pavement markings.

Enforcement, Education, and Maintenance

Because the high visibility pavement marking is installed in the travel lane, it will be necessary to maintain the markings. In some cases the markings (e.g., “ladder style” markings) can be designed so there is little or no pavement marking in the typical motor vehicle wheel paths.

Summary

Exhibit 9-12 summarizes the issues associated with high visibility crosswalks.

Characteristic	Potential Benefits	Potential Concerns
Safety	Decreased risk of pedestrian collisions.	None identified.
Operations	None identified.	None identified.
Multimodal	Enhanced space for pedestrian and bicyclists to cross.	None identified.
Physical	Installation can occur in the same footprint as standard crosswalks.	None identified.
Socioeconomic	None identified.	None identified.
Enforcement, Education, and Maintenance	Improved compliance.	Enhanced crosswalks may require additional effort to maintain pavement markings.

Exhibit 9-12. Summary of issues for high visibility crosswalks.

9.2 BICYCLE TREATMENTS

9.2.1 Provide Bicycle Box

Description

A bicycle box uses advance stop lines placed on the approach to a signalized intersection, typically in the rightmost lane, at a location upstream from the normal stop line location. These create a dedicated space for bicyclists—a bicycle box—to occupy while waiting for a green indication. Advance stop lines are used in conjunction with bicycle lanes or other similar bicycle provisions.

Note that this treatment is considered experimental; it is not currently identified in the MUTCD.

Applicability

This treatment may apply in situations where vehicle-bicycle collisions have been observed in the past, or vehicle/bicycle conflicts are observed in field observations. The treatment may be considered if a bike lane exists on the approach.

In locations with a high volume of right-turning motor vehicle traffic, use of this treatment may be beneficial.

Safety Performance

Such a treatment was found to be effective in Europe, resulting in a 35 percent reduction in through-bicycle/right-turning-vehicle collisions.⁽¹²⁶⁾

Operational Performance

This treatment is not expected to have a significant effect on traffic operations unless a high volume of right-turning traffic is present.

Multimodal Impacts

Bicycle boxes permit bicyclists to pass other queued traffic on the intersection approach leg, giving them preferential treatment in proceeding through the intersection.

Enforcement, Education, and Maintenance

Concerns with providing a bicycle box include motorist violation of existing stop line, a lack of uniformity with other intersections, and a need for right-turn-on-red prohibitions. Users are not yet familiar with this application, so heavy education may be required.

Summary

Exhibit 9-13 summarizes the issues associated with providing a bicycle box.

Characteristic	Potential Benefits	Potential Concerns
Safety	Potential reduction in collisions between through bicycles and right-turning vehicles.	None identified.
Operations	None identified.	None identified.
Multimodal	Bicyclists can bypass queued traffic, thus reducing delay.	None identified.
Physical	None identified.	None identified.
Socioeconomic	None identified.	None identified.
Enforcement, Education, and Maintenance	None identified.	Enforcement of the box may be necessary.

Exhibit 9-13. Summary of issues for providing a bicycle box.

9.2.2 Provide Bike Lanes

Description

While bicycle lanes are frequently used on street segments, AASHTO cautions against the use of bicycle lane markings through intersections.⁽²⁶⁾ Special lanes for bicyclists can cause problems to the extent that they encourage bicyclists and motorists to violate the rules of the road for drivers of vehicles. Specifically, a bike lane continued to an intersection encourages right-turning motorists to stay in the left lane, not the right (bike) lane, in violation of the rule requiring that right turns be made from the lane closest to the curb. Similarly, straight-through, or even left-turning, bicyclists are encouraged to stay right. Installation of bike lanes at signalized intersections is associated with a range of vehicle-bicycle crash effects – both increases and decreases.⁽¹²⁷⁾

The bike lane shall be positioned between the through lane and the right-turn only lane. A right-turn-only lane encourages motorists to make right turns by moving close to the curb (as the

traffic law requires). A bicyclist going straight can easily avoid a conflict with a right-turning car by staying to the left of the right-turn lane. A bike lane to the left of the turn lane encourages bicyclists to stay out of the right-turn lane when going straight. The MUTCD requires through bicycle lanes to be positioned only to the left of a right-turn-only lane and to the right of a left-turn-only lane.

Applicability

This treatment may be applicable in situations where there are a high number of bicyclists using the road or where bicycle use is being promoted or encouraged.

Safety Performance

Some European literature suggests that bicycle lane markings can increase motorist expectation of bicyclists; one Danish study found a 36 percent reduction in bicycle collisions when these were marked.⁽¹²⁸⁾ Other research concludes that bicycle paths along arterials typically increase bicyclists' vulnerability to a collision at signalized intersections; however, raised and brightly colored crossings reduce the number of bicycle/vehicle conflicts and should improve safety.⁽¹²⁰⁾ Installation of colored bike lanes at signalized intersections has been associated with a 39 percent reduction in vehicle/bicycle crashes.⁽¹²⁷⁾

Multimodal Impacts

Bicycle lanes delineate roadway space between motor vehicles and bicycles and provide for more predictable movements by each.⁽²⁶⁾

Physical Impacts

Bicycle lanes may require additional right-of-way unless width is taken from the existing travel and/or parking lanes, either by lane narrowing or the removal of a lane.

Summary

Exhibit 9-14 summarizes of the issues associated with providing bicycle lanes.

Characteristic	Potential Benefits	Potential Concerns
Safety	Potential reduction in vehicle/bicycle collisions.	Potential increase in vehicle/bicycle collisions.
Operations	None identified.	None identified.
Multimodal	Bicycle lanes delineate roadway space between motor vehicles and bicycles and provide for more predictable movements by each.	None identified.
Physical	None identified.	Bicycle lanes may require additional right-of-way unless width is taken from existing lanes.
Socioeconomic	None identified.	None identified.
Enforcement, Education, and Maintenance	None identified.	None identified.

Exhibit 9-14. Summary of issues for providing bicycle lanes.

9.3 TRANSIT TREATMENTS

9.3.1 Relocate Transit Stop

Placement of bus stops in the vicinity of intersections can significantly influence safety and operational performance. Approximately 2 percent of pedestrian accidents in urban areas and 3 percent in rural areas are related to bus stops.⁽¹²⁹⁾ Proper placement and provisions at bus stops can reduce several safety and mobility problems. Traffic engineers often have two choices with regard to bus stop placement in the vicinity of an intersection: on the near side (upstream) or far side (downstream). The 1996 *Transit Cooperative Research Program (TCRP) Report 19: Guidelines for the Location and Design of Bus Stops* provides a comprehensive comparative analysis of far-side, near-side, and midblock placement of bus stops.⁽¹²⁹⁾

Application

Relocation of a transit stop to a location upstream of the intersection (near side) should be considered in situations where there is congestion on the far side of the intersection during peak periods.

Relocation of a transit stop to a location downstream of the intersection (far side) should be considered in situations where one or more of the following exist:

- Heavy right-turn movement.
- Conflicts between vehicles trying to turn right, through vehicles, and stationary near-side buses, resulting in rear-end and sideswipe collisions.
- Pedestrian collisions because pedestrians cross in front of a stationary bus and are struck by a vehicle.

Safety Performance

One advantage of near-side placements is that the bus driver has the entire width of the intersection available to pull away from the curb. Near-side bus placements increase conflicts between right-turning vehicles, through traffic, and the bus itself. When the bus is stopped at the bus stop, traffic control devices, signing, and crossing pedestrians are blocked from view. Vehicles on the adjacent approach to the right may have difficulty seeing past a stopped bus while attempting a right turn on red.

Far-side bus stop placements minimize conflicts between right-turning vehicles and buses. Relocating the bus stop to the far side of the intersection can also improve safety by eliminating the sight distance restriction caused by the bus and encouraging pedestrians to cross the street from behind the bus instead of in front of it.⁽¹³⁰⁾ The presence of a far-side transit bus stop is associated with a 45 percent reduction in transit-related crashes.⁽¹³¹⁾ The 1996 TCRP report recommends a minimum clearance distance of 5 ft between a pedestrian crosswalk and the front or rear of a bus stop.⁽¹²⁹⁾ Finally, the bus driver can take advantage of gaps in the traffic flow that are created at signalized intersections. However, far-side bus stops may cause rear-end collisions, as drivers often do not expect buses to stop immediately after the traffic signal.

Far-side bus stops appear to offer greater overall safety.

Operational Performance

Near-side bus stop placements minimize interference with through traffic in situations where the far side of the intersection is congested. This type of placement also allows the bus driver to look for oncoming traffic, including other buses with potential passengers for the stopped bus. However, if the bus stop services more than one bus, the right and through lanes may be temporarily blocked.

Far-side bus stop placements improve the right-turn capacity of the intersection. Yet they may block the intersection during peak periods by stopping buses or by a traffic queue extending

back into the intersection. Also, if the light is red, it forces the bus to stop twice, decreasing the efficiency of bus operations.

Multimodal Impacts

Near-side bus stop placements allow pedestrians to access buses closest to the crosswalk, and allow pedestrians to board, pay the fare, and find a seat while the bus is at a red light. However, placing the bus stops on the near side of intersections or crosswalks may block pedestrians' view of approaching traffic and the approaching drivers' view of pedestrians.⁽¹⁰⁴⁾

Physical Impacts

Near-side bus stops/bus shelter placements may interfere with the placement of a red-light camera.

Socioeconomic Impacts

Relocation of a bus stop is a relatively low-cost improvement, unless it involves the relocation of a bus bay and shelter.

Enforcement, Education, and Maintenance

Some jurisdictions have implemented or are considering a yield-to-bus law. If implemented, this would require all motorists to yield to buses pulling away from a bus stop and reduce transit/vehicle conflicts.

Far-side bus bays provide a location for police officers to conduct red-light running or speed enforcement, and can also facilitate U-turns.

From a driver education point of view, the traffic engineer and transit agency may consider consistently placing the bus stop either on the near side or the far side, so that motorists have an expectation of where the bus is going to stop at all signalized intersections in their jurisdiction.

Summary

Exhibit 9-15 summarizes of the issues associated with providing near-side or far-side transit stops.

Characteristic	Potential Benefits	Potential Concerns
Safety	Right-turning vehicle conflicts (far side). Sight distance issues for crossing pedestrians/vehicles on adjacent approach (far side). Rear-end conflicts (near side).	Right-turning vehicle conflicts (near side). Sight distance issues for crossing pedestrians/vehicles on adjacent approach (near side). Rear-end conflicts (far side).
Operations	Eliminates double stopping (near side).	Right-turn/through lanes may be blocked (near side). Intersection may be blocked (far side).
Multimodal	Passenger can board while light is red (near side). Less walking distance to crosswalk (near side).	None identified.
Physical	None identified.	May interfere with red-light camera placement (near side).
Socioeconomic	None identified.	Relocation (far or near) may be costly if it involves relocation of bus bay/bus shelter.
Enforcement, Education, and Maintenance	Far-side bus bays provide space for enforcement vehicles.	Enforcement of yielding to buses may be necessary.

Exhibit 9-15. Summary of issues for near-side/far-side transit stops.

9.4 TRAFFIC CONTROL TREATMENTS

Intersection-wide traffic control treatments can provide operational and/or safety benefits on all approaches and for all movements. Signal coordination improves traffic flow for through traffic and provides gaps for left-turn movements. Signal preemption and priority identifies and accommodates critical movements and users. Signal controller upgrades (from pre-timed to actuated) accommodate intersections where traffic flow is highly variable, reducing delays and driver frustration. Change and clearance interval adjustments can address a red-light running problem. Cycle length can also be adjusted based on the nature of the traffic flow through the intersection. Finally, the advisability of removal of a signalized intersection from late night/early morning flash mode should be evaluated.

9.4.1 Change Signal Control from Pre-timed to Actuated

Description

Traffic signal control at an intersection may be pre-timed, semi-actuated, actuated, adaptive or traffic responsive. A pre-timed mode of control could simply be a function of the capabilities of the controller (older controllers may not have actuated capabilities), or it could be a byproduct of the lack of detection at the intersection (for example, a modern controller with full actuated capabilities may be required to run pre-timed if no detection is in place). The mode of control used can have a profound effect on the operational efficiency and safety of the signalized intersection.

A pre-timed controller operates within a fixed cycle length using preset intervals and no detection. Pre-timed traffic control signals direct traffic to stop and permit it to proceed in accordance with a single predetermined time schedule or series of schedules.

Traffic engineers should consider upgrading intersections from pre-timed to more efficient types of control. Semi-actuated traffic signals have detectors located on the minor approaches and oftentimes in the left-turn lanes of the major approaches. Fully actuated traffic signals have

detection on all approaches, have varying cycle lengths, and ensure acceptable servicing through basic controller timings.

Traffic responsive control uses system and presence detection to select one of a set of timing plans (pre-timed) based upon the traffic demand. This type of control further optimizes the operation by using the presence detection on the side streets and left turns to allocate unused green time to other phases as needed. Adaptive control dynamically assigns green time for each phase based upon system detection.

Selecting the best type of control for a location requires full knowledge of local conditions, but, in general, can be based on:

- Variations in peak and average hourly traffic volumes on the major approaches.
- Variations in morning and afternoon hourly volumes.
- Percentage of volumes on the minor approaches.
- Usage by large vehicles, pedestrians, and bicycles.
- Capabilities of existing traffic control equipment.
- Locations where main or side street traffic could benefit from progression or platooning.

Applicability

Converting a signal from pre-timed to a more efficient type of control may be considered in the following situations:

- Where fluctuations in traffic cannot be anticipated and thus cannot be programmed with pre-timed control.
- At complex intersections where one or more movements are sporadic or subject to variations in volume.
- At intersections that are poorly placed within a traffic corridor of intersections with pre-timed traffic signals.
- To minimize delay in periods of light traffic.

Safety Performance

Actuated traffic signals and traffic signal systems control (intelligent signal systems) provide better service to all movements at an intersection, reducing driver frustration and the likelihood of red-light running. However, they can also make it more difficult for pedestrians with visual impairments to predict when changes in signal phasing will occur. There is little research on the safety effects of changing signal control from pre-timed to actuated, but the possibility of reduced rear-end and red-light running crashes due to fewer stops makes actuation a potential safety measure.

Operational Performance

Intelligent signal systems, used in appropriate situations, can reduce delays to vehicles, particularly in light traffic situations and for movements from minor approaches.

Benefits of intelligent signal systems may be less significant in situations where traffic patterns and volumes are predictable and do not vary significantly. Actuated control only may not be the best choice where there is a need for a consistent starting time and ending time for each phase to facilitate signal coordination with traffic signals along a corridor. Actuated signals are dependent on the proper operation of detectors; therefore, they are affected by a stalled vehicle, vehicles involved in a collision, or construction work. To a lesser degree, other types of intelligent signal control operation could be impacted by malfunction or loss of system detectors. Most intelligent signal systems rely upon fail-safe timing plans when one or more groups of detectors fail.

Multimodal Impacts

Pre-timed traffic signals may be more acceptable to the unfamiliar pedestrian than traffic-actuated signals in areas where there is large and fairly consistent pedestrian traffic crossing the road. Intelligent signal systems may cause confusion to the pedestrian with the operation of pedestrian push buttons where long cycle lengths or adaptive control is present. Actuated pedestrian push buttons must be located in appropriate locations and be accessible to be ADA compliant.

Physical Impacts

Approaches needing actuation require detectors. Depending on the type of detector, this may create physical impacts (see Chapter 5 for further discussion of detector types).

Socioeconomic Impacts

Generally speaking, intelligent signal system equipment costs more to purchase and install than pre-timed traffic controllers, although almost all traffic controllers purchased today are capable of actuated operation. Depending on the geometry, number of lanes, and traffic characteristics, detection can be a significant percentage of the cost of a signalized intersection, but many of the more advanced, newer types of detection can cover an entire approach (lefts and throughs) per unit.

Enforcement, Education, and Maintenance

Pre-timed traffic signals may lead to driver frustration in low-volume situations, as in the late evening/early morning hours, as the driver waits for the signal to change green while no other vehicles are present on the other approaches. This may lead to red-light running.

Intelligent signal systems require more equipment and components, and can be more costly to maintain. Detector and/or signal indication (bulb, lens, LED) failure are the most common public complaints.

Summary

Exhibit 9-16 summarizes the issues associated with providing signal actuation.

Characteristic	Potential Benefits	Potential Concerns
Safety	Improves safety. Reduces driver frustration, red-light running.	None identified.
Operations	Provides better service to minor approaches. Accommodates widely fluctuating volumes.	Can sometimes reduce smooth platooning in coordinated systems. Requires proper operation of detectors.
Multimodal	None identified.	May be problematic for unfamiliar pedestrians due to variations to cycle lengths or longer cycle lengths.
Physical	None identified.	Detectors required.
Socioeconomic	None identified.	Can be costly.
Enforcement, Education, and Maintenance	Enforcement needs may decrease.	Maintenance costs will likely increase to maintain detection.

Exhibit 9-16. Summary of issues for providing signal actuation.

9.4.2 Modify Change and Clearance Intervals (Yellow and All-Red)

Description

The yellow change interval warns approaching traffic of the change in assignment of right-of-way. Yellow change intervals, a primary safety measure used at traffic signals, are the subject of much debate. The yellow change interval is normally between 3 and 6 seconds. Since long yellow change intervals may encourage drivers to use it as a part of the green interval, a maximum of 5 seconds is commonly employed. Longer yellow intervals are generally associated with higher approach speeds. Local practice dictates the length of the change interval.

The ITE standard formula for change intervals is as follows:

$$CP = t + \frac{V}{2a + 64.4g} + \frac{W + L}{V} \quad (\text{U.S. Customary})$$

where:

- CP = change period (s)
- t = perception-reaction time of the motorist (s); typically 1
- V = speed of the approaching vehicle (ft/s)
- a = comfortable deceleration rate of the vehicle (ft/s²); typically 10 ft/s²
- W = width of the intersection, curb to curb (ft)
- L = length of vehicle (ft); typically 20 ft
- g = grade of the intersection approach (%); positive for upgrade, negative for downgrade

Intersections where the existing yellow change interval time is less than the time needed for a motorist traveling at the prevailing speed of traffic to reach the intersection or stop comfortably before the signal turns red will require a longer yellow change interval. The minimum length of yellow should be determined using the kinematics formula in the 1985 ITE proposed practice assuming an average deceleration of 10 ft/s or less, a reaction time of 1 second or more, and an 85th percentile approach speed. An additional 0.5 seconds of yellow time should be considered for locations with significant truck traffic, significant population of older drivers, or more than 3 percent of the traffic entering on red.⁽¹³³⁾

The red clearance interval is an optional interval that follows the yellow change interval and precedes the next conflicting green interval. The red clearance interval provides additional time following the yellow change interval before releasing conflicting traffic. The decision to use a red clearance interval is determined based on engineering judgment and assessment of any of the following criteria:

- Intersection geometrics.
- Collision experience.
- Pedestrian activity.
- Approach speeds.
- Local practices.

The red clearance interval is typically either set by local policy or calculated using an equation that determines the time needed for a vehicle to pass through the intersection. The equation most commonly used is described in various documents⁽¹³⁴⁾ (and Chapter 5). As intersections are widened to accommodate additional capacity, the length of the calculated clearance interval increases. This increase may contribute to additional lost time at the intersection, which negates some of the expected gain in capacity due to widening.

Applicability

Modifying the yellow or red clearance interval may be considered where:

- A high number of angle/left-turn collisions occur due to through/left-turning drivers failing to clear the intersection or stop before entering the intersection at onset of the red.
- A high number of rear-end collisions occur because drivers brake sharply to avoid entering the intersection at the onset of the red.
- A high number of red-light violations are recorded.

Safety Performance

At intersection approaches where yellow signal timing duration is set below values associated with ITE guidelines or similar kinematic-based formulae, increasing yellow change interval duration to achieve ITE guidelines can significantly reduce red-light running. Increasing yellow change and/or red clearance interval timing to achieve values associated with ITE guidelines or similar kinematic formulae can significantly reduce motorists entering the intersection at the end of the yellow phase.

The best estimate of the crash effects associated with implement improved change interval timing, based on before-after studies, is about 8 to 14 percent reduction in total crashes, and about a 12 percent decrease in injury crashes.⁽¹³⁵⁾

Research shows that yellow interval duration is a significant factor affecting the frequency of red-light running and that increasing yellow time to meet the needs of traffic can dramatically reduce red-light running. Bonneson and Son (2003) and Zador et al. (1985) found that longer yellow interval durations consistent with the ITE Proposed Recommended Practice (1985) of using 85th percentile approach speeds are associated with fewer red-light violations, all other factors being equal. Bonneson and Zimmerman (2004) found that increasing yellow time in accordance with the ITE guideline or longer reduced red light violations more than 50 percent. Van Der Host found that red light violations were reduced by 50 percent one year after yellow intervals were increased by 1 seconds.⁽¹⁴⁰⁾ Retting et al (2007) found increasing yellow time in accordance with the guideline reduced red-light violations by 36 percent on average. Retting, Chapline & Williams (2002) found that adjusting the yellow change interval in accordance with the ITE guidelines reduced total crashes by 8 percent, right-angle crashes by 4 percent, and pedestrian and bicycle crashes by 37 percent.⁽⁷⁸⁾

One study conducted by Souleyrette et al. (2004), suggests modest short-term crash reductions, but no longer-term effects associated with installing red clearance intervals.⁽¹³⁶⁾

Exhibit 9-17 presents selected findings associated with signal clearance modifications.

Treatment	Finding
Retiming to ITE standards. ⁽¹³⁷⁾	Reduced red-light violations by 50 percent.
Add all-red clearance interval. ⁽¹³⁶⁾	Modest short-term crash reductions, but no longer-term effects.
Retiming signal change intervals to ITE standards. ⁽¹³⁸⁾	8 percent estimated reduction in all collisions. 12 percent estimated increase in rear-end collisions. 39 percent estimated reduction in vehicle-bicycle and vehicle-pedestrian collisions.
Retiming signal change intervals to ITE standards. ⁽¹³⁹⁾	5 percent estimated reduction in all collisions. 9 percent estimate reduction in fatal and injury collisions.

Exhibit 9-17. Safety effects associated with modifying change and clearance intervals: selected findings.

Operational Performance

Extending the yellow and red interval will increase the amount of lost time, decreasing the overall efficiency of the intersection.

Multimodal Impacts

Either extending the yellow and/or red clearance interval or providing a red clearance interval will benefit pedestrians, giving them additional time to clear the intersection. The elderly or people with mobility disabilities may benefit substantially.

Physical Impacts

No physical impacts are associated with this treatment.

Socioeconomic Impacts

The treatment has been shown to reduce red-light running at a wide variety of signalized intersections.

Enforcement, Education, and Maintenance

Local practice varies as to legal movements during the yellow phase. Police, traffic engineering staff, and the public need to be clear and in agreement about what is permissible in their jurisdiction.

Summary

Exhibit 9-18 summarizes the issues associated with modifying yellow and/or red clearance intervals at signalized intersections.

Characteristic	Potential Benefits	Potential Concerns
Safety	Angle collisions are reduced. Left-turn collisions are reduced. Rear-end collisions are reduced.	None identified.
Operations	None identified.	Increased lost time.
Multimodal	The elderly and people with mobility disabilities have more time to cross.	None identified.
Physical	No physical requirements.	None identified.
Socioeconomic	Low-cost alternative to police and automated enforcement.	None identified.
Enforcement, Education, and Maintenance	Red-light enforcement may become less necessary.	None identified.

Exhibit 9-18. Summary of issues for modifying yellow/red clearance intervals.

9.4.3 Modify Cycle Length

Description

Calculating and selecting cycle length requires judgment on the part of the traffic engineer or analyst. General practice suggests a cycle length between 50 and 120 seconds. For low-speed urban roads, a shorter cycle length is preferable (50 to 70 seconds). For wider roadways (greater than 50 ft) with longer pedestrian crossing times (greater than 20 s seconds), or in situations where heavier traffic is present and left-turning vehicles are not effectively accommodated, a cycle length of 60 to 90 seconds may be preferable. At high-volume intersections, multiple phases to accommodate heavy turning movements may necessitate a cycle length of 90 to 120 seconds.⁽¹⁴⁰⁾ In addition, cycle lengths longer than 120 seconds may be needed at large intersections to accommodate multiple long pedestrian crossings in combination with heavy turning movements, especially during peak periods. Typically, system cycle lengths are governed by the higher volume intersections within the system and limit the flexibility of the traffic engineer in choosing a cycle length that may otherwise work better for a specific location.

Safety Performance

Longer cycle lengths may lead to driver frustration and red-light running, as it may take several cycles for a motorist to get through the intersection, particularly when attempting a left turn against opposing traffic. However, because an increase in cycle length reduces driver exposure to the yellow indication (e.g., a cycle length change from 60 to 120 seconds reduces the number of times that the yellow is presented by 50 percent), there is an inverse relationship between a change in cycle length and the frequency of red-light-running. That is, an increase in cycle length corresponds to a decrease in the frequency of red-light-running.⁽¹⁴¹⁾

No known research or specific collision modification factors exist for modifying cycle length.

Operational Performance

A cycle length of 90 seconds is often considered optimum, since lost time is approaching a maximum, capacity is approaching a minimum, and delay is not too great.⁽¹⁴⁰⁾ Longer cycle lengths may lead to excessive queuing on the approach and will interfere with turning movements (left- and right-turn channelization) if through traffic is severely backed up.

Conversely, intersection capacity drops substantially when cycle lengths fall below 60 seconds, as a greater percentage of available time is used up in the yellow and red clearance intervals.

Multimodal Impacts

A shorter cycle length may not provide pedestrians with sufficient time to safely cross the intersection, particularly if it has turning lanes. Conversely, a longer cycle length may encourage impatient pedestrians to cross illegally during the red phase.

Physical Impacts

No physical impacts are associated with the modification of cycle length.

Enforcement, Education, and Maintenance

As part of regular traffic signal observations (recommended every 3 to 5 years, or as needed), consider modifying cycle lengths and splits (and offsets in coordinated systems) to accommodate emerging operational needs.

Socioeconomic Impacts

No significant costs are associated with this treatment, apart from labor.

Summary

Exhibit 9-19 summarizes the issues associated with cycle length modification.

Characteristics	Potential Benefits	Potential Concerns
Safety	Increase in cycle length corresponds to a decrease in the frequency of red-light running.	Longer cycle lengths could induce some drivers to run red lights.
Operations	Reduction in delay optimized at 90 seconds.	Excessive queuing (with longer cycle lengths). Inadequate capacity (with cycle lengths that are too short).
Multimodal	None identified.	Inadequate crossing time for pedestrians (with cycle lengths that are too short).
Physical	None identified.	None identified.
Socioeconomic	None identified.	None identified.
Enforcement, Education, and Maintenance	None identified.	Increased maintenance cost of regular signal observations and retiming.

Exhibit 9-19. Summary of issues for cycle length modifications.

9.4.4 Late Night/Early Morning Flash Removal

Description

Some jurisdictions operate traffic signals in flashing mode during various periods of the night, the week, or for special events. Flashing operation can benefit traffic flow, particularly with pre-timed signals, when traffic is very light (late evening/early morning hours, or on a Sunday or holiday in an industrial area).

Two modes of flashing operation are typically used: red-red and red-yellow. Red-red (all approaches receive a flashing red indication) is used where traffic on all approaches is roughly the same. In this instance, the intersection operates as an all-way stop. Red-yellow (the minor street receives a flashing red indication and the major street receives a flashing yellow indication) is used in situations where traffic is very light on the minor street. In this instance, the intersection operates as a two-way stop.

Safety Performance

One study examined safety impacts associated with converting 12 intersections from nighttime flashing operation to steady operation in Winston-Salem, NC. The analysis indicated that flashing operation reduced nighttime angle crashes (the ones most likely to be positively affected) by approximately 34 percent. Total nighttime crashes also saw a significant reduction of approximately 35 percent.⁽¹⁴²⁾

A separate study evaluated safety impacts associated with a change in statewide late night flash policy by the North Carolina DOT making it standard practice to operate signals in steady mode at all times. Before this policy, it was standard practice to allow traffic signals to operate in late night flash mode unless directed otherwise by the division traffic engineer. The policy also changed the standard operating times for late night flash operations. As a result of this policy, many signals were either removed from late night flash operations or had their late night flash operating times modified to conform to the new policy. Replacing nighttime flash with steady operation was associated with an estimated 48 percent reduction in nighttime frontal and opposing direction sideswipe collisions and head-on collisions, and an estimated 27 percent reduction in all nighttime collisions.

Selected study findings associated with the removal of a traffic signal from a flashing mode operation (such as during the late-night/early morning time period) are shown in Exhibit 9-20.

Treatment	Finding
Remove signal from late night/early morning flash mode. ^{(142),(143)}	34 percent estimated reduction in nighttime angle collisions. 35 percent estimated reduction in all nighttime collisions. 48 percent estimated reduction in nighttime frontal and opposing direction sideswipe collisions and head-on collisions 27 percent estimated reduction in all nighttime collisions

Exhibit 9-20. Safety effects associated with removal of signal from late night/early morning flash mode: selected findings.

Operational Performance

If the signalized intersection removed from flashing operation is not fully actuated and responsive to traffic demand, increased red-light violations and/or complaints about unnecessary long waits on red signals may occur.

Multimodal Impacts

Removing a traffic signal from a flash mode will require vehicles to come to a complete stop during the red phase. This treatment should give vehicles more time to see, respond, and yield to any pedestrians.

Physical Impacts

No physical impacts are associated with this treatment.

Socioeconomic Impacts

No costs are associated with this treatment.

Enforcement, Education, and Maintenance

When a traffic signal is taken out of flash mode, police enforcement could be undertaken at the location to ensure habituated drivers do not proceed through the intersection as if the signal were still operating in flashing mode. The traffic engineer may consider temporary signing/publicity to inform motorists of the change in operations and to explain the safety benefits.

Summary

Exhibit 9-21 summarizes the issues associated with flash mode removal.

Characteristic	Potential Benefits	Potential Concerns
Safety	Angle collisions are reduced.	Could induce red-light running on minor legs if controller is not sufficiently sensitive to minor road demand.
Operations	None identified.	Increased delay for through traffic.
Multimodal	Motorists forced to yield to pedestrians.	None identified.
Physical	None identified.	None identified.
Socioeconomic	None identified.	None identified.
Enforcement, Education, and Maintenance	None identified.	Enforcement and temporary signing may be needed for a period after conversion.

Exhibit 9-21. Summary of issues for flash mode removal.

9.5 STREET LIGHTING AND ILLUMINATION

9.5.1 Provide or Upgrade Illumination

Description

The purpose of roadway lighting is to enhance visibility and conspicuity for drivers, bicyclists, and pedestrians, thereby improving their ability to see each other and the physical infrastructure of the intersection. This allows them to react more quickly and accurately to each other when natural light drops below a certain level, either at night or during bad weather.

Applicability

Consider intersection lighting at all signalized intersections. More nighttime collisions than expected may justify upgrades, particularly if the nighttime collisions involve pedestrians, bicyclists, and/or fixed objects.

Design Features

The illumination design at an intersection should meet lighting criteria established by the Illuminating Engineering Society of North America (IESNA) in IESNA RP-8-00, *American National Standard Practice for Roadway Lighting*.⁽⁷⁰⁾ The basic principles and design values for intersections have been presented previously (Chapter 5) and include overall light level and uniformity of lighting.

Some of the factors that affect the light level and uniformity results include:

- Luminaire wattage, type, and distribution.
- Luminaire mounting height.
- Pole placement and spacing.

These factors are interrelated. For example, higher mounting heights improve uniformity by spreading the light over a larger area; however, the overall light level decreases unless larger wattages are used or poles are placed closer together. Good illumination design balances these various factors against an overall desire to minimize the number of poles and fixtures (both for cost savings and for minimizing the number of fixed objects in the right-of-way).

Pole Placement and Spacing

Besides the types of poles and fixtures, the placement is also an important aspect of a good roadway design. Several factors need to be considered in pole placement. The first is safety. Most important is to place the pole at an offset distance that can assist in preventing crashes (vehicles and pedestrians). Second, determine the pole spacing most efficacious for initial and long-term maintenance costs, yet still meeting the lighting requirement. At intersections, shared use of poles for signal equipment and illumination is recommended. Exhibit 9-22 shows examples from RP-8-00 of illumination pole layouts typical at signalized intersections with and without channelized right-turn lanes. However, recent research to improve lighting at midblock pedestrian crosswalks suggests it may be desirable to locate poles approximately one third to one half the luminaire mounting height back from the crosswalk to improve lighting for pedestrians. This may require separate poles for signal equipment and luminaires.⁽¹⁴⁴⁾ For intersections providing separate pedestrian pedestals at the crosswalk, the mast arm poles for vehicle signal heads should be located for optimal illumination as well. Intersection lighting, when crosswalks are present, should account for the presence of pedestrians and attempt to achieve positive contrast.

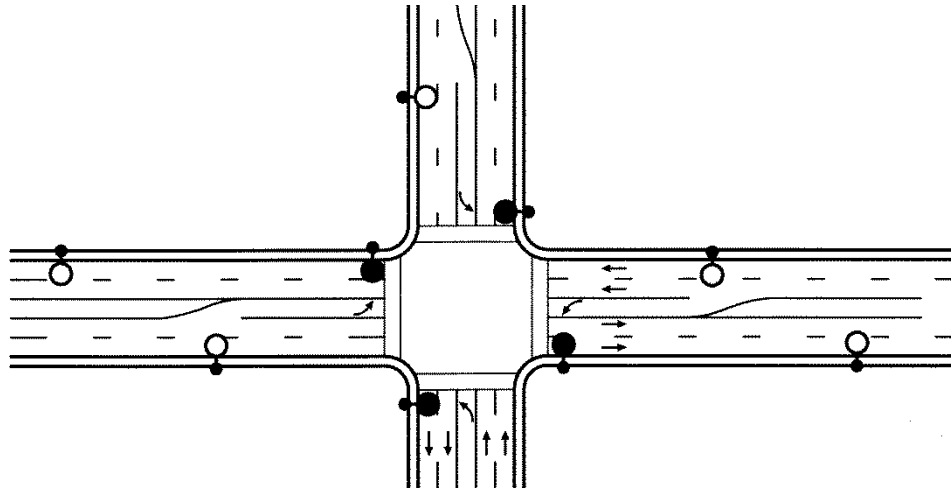

(a) Typical lighting layout for intersection without right-turn bypass lane.

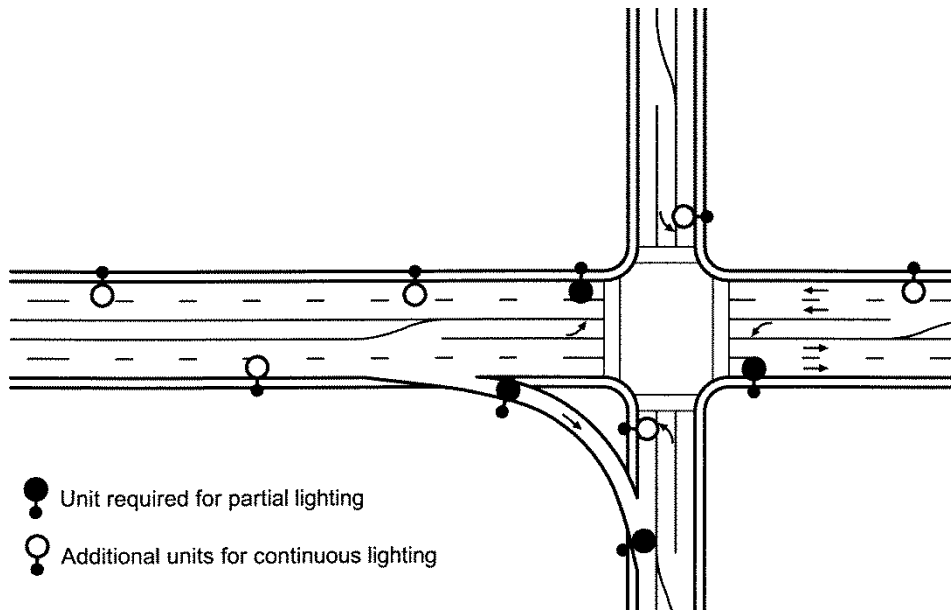

(b) Typical lighting layout for intersection with right-turn bypass lane.

Exhibit 9-22. Typical lighting layouts.^(70, figure D3)

Safety Performance

Optimal illumination and visibility reduces the chance of nighttime accidents and enhances traffic flow. Roadway lighting also increases sight distance, security, and the use of surrounding facilities. Installation of lighting at intersections is associated with a 38 percent reduction in all dark condition collisions and a 42 to 59 percent reduction in vehicle/pedestrian collisions in dark conditions.⁽¹⁴⁵⁾

Operational Performance

No documented relationship exists between illumination and operational intersection performance. The authors believe that illumination likely has little effect on traffic flow, delay, and queuing.

Multimodal Impacts

As noted above, illumination demonstrably reduces pedestrian crashes and provides a more secure nighttime environment for all intersection users.

Physical Impacts

Illumination typically has little effect on the overall footprint of an intersection. Commonly, combination poles support both signal heads and luminaires, so additional poles are rarely needed in the immediate vicinity of the intersection. However, the recent research cited previously suggests the possibility of improved pedestrian visibility using additional poles upstream from the crosswalk.

Socioeconomic Impacts

Illumination also reduces the fear of crime at night, and it promotes business and the use of public streets at night.⁽⁷⁰⁾

In addition to the initial capital cost and maintenance of illumination fixtures, illumination requires energy consumption. The Roadway Lighting Committee of IESNA believes that lighting of streets and highways is generally economically practical and that such preventive measures can cost a community less than the crashes caused by inadequate visibility.⁽⁷⁰⁾ Judicious design of luminaire types, wattages, mounting height, and pole spacing may increase visibility at the intersection without significantly increasing energy costs.

Summary

Exhibit 9-23 summarizes the issues associated with providing illumination.

Characteristic	Potential Benefits	Potential Disbenefits
Safety	Reported reductions in nighttime collisions.	None identified.
Operations	None identified.	None identified.
Multimodal	May reduce pedestrian crashes.	None identified.
Physical	Little impact.	None identified.
Socioeconomic	May reduce fear of nighttime crime.	Additional energy consumption.
Enforcement, Education, and Maintenance	None identified.	Maintenance of illumination will be necessary.

Exhibit 9-23. Summary of issues for providing illumination.

9.6 REMOVE TRAFFIC SIGNAL

As indicated in Section 4B.03 of the MUTCD, improper or unjustified traffic control signals can result in one or more of the following disadvantages:

- Excessive delay.
- Excessive disobedience of the signal indications.
- Increased use of less adequate routes as road users attempt to avoid the traffic control signals.
- Significant increases in the frequency of collisions (especially rear-end collisions).

Converting traffic signals to roundabouts or multi-way stop controls at appropriate settings and under appropriate traffic conditions can provide a range of safety, operational, environmental, and economic benefits.

9.6.1 Convert Signalized Intersection to a Roundabout

Description

The modern roundabout is a circular intersection with design features promoting safe and efficient traffic flow. At roundabouts in the United States, vehicles travel counterclockwise around a raised center island, with entering traffic yielding the right-of-way to circulating traffic. In urban settings, entering vehicles negotiate a curve sharp enough to slow speeds to about 15 to 20 mph; in rural and suburban settings, entering vehicles may be held to somewhat higher speeds (30 to 35 mph). Within the roundabout and as vehicles exit, slow speeds are maintained by the deflection of traffic around the center island and the relatively tight radius of the roundabout and exit lanes. Roundabouts have replaced many formerly signalized intersections.

Applicability

Converting a signalized intersection to a roundabout requires sufficient right-of-way to accommodate the circumference of the roundabout, which may include one, two, or three circulating lanes, depending on the volume of traffic. Mini roundabouts can be installed with less right-of-way, including some cases where no additional right-of-way is needed.

Safety Performance

Conversion of signalized intersections to roundabouts is associated with substantial safety benefits. Before-after analysis conducted for nine such conversions as part of NCHRP Report 672 estimated a 48 percent reduction in all crashes, and a 78 percent reduction in injury crashes. ⁽¹⁴⁶⁾

Treatment	Finding
Convert signalized intersection to roundabout. ⁽¹⁴⁶⁾	48 percent estimated reduction in all collisions. 78 percent estimated reduction in injury collisions.

Exhibit 9-24. Safety effects associated with converting traffic signals to roundabouts: selected findings.

Operational Performance

In addition to providing safety effects, converting signalized intersections to roundabouts is associated with substantial reductions in vehicle delay. Several studies have reported significant improvements in traffic flow following conversion of traditional intersections to roundabouts. A study of three locations in New Hampshire, New York, and Washington, where roundabouts replaced traffic signals or stop signs, found an 89 percent average reduction in vehicle delays and

a 56 percent average reduction in vehicle stops.⁽¹⁴⁸⁾ A study of 11 intersections in Kansas found a 65 percent average reduction in delays and a 52 percent average reduction in vehicle stops after roundabouts were installed.⁽¹⁴⁹⁾

Multimodal Impacts

Conversion of signalized intersections to roundabouts can benefit pedestrians. Roundabouts generally are safer for pedestrians than traditional intersections. In a roundabout, pedestrians walk on sidewalks around the perimeter of the circular roadway. If they need to cross the roadway, they cross only one direction of traffic at a time. In addition, crossing distances are relatively short, and traffic speeds are lower than at traditional intersections. Studies in Europe indicate that, on average, converting conventional intersections to roundabouts can reduce pedestrian crashes by about 75 percent.^{(150),(151)} Single-lane roundabouts in particular have been reported to involve substantially lower pedestrian crash rates than comparable intersections with traffic signals. Safety studies on bicyclists at roundabouts have mixed findings, with some European studies showing higher crash rates for bicycles at roundabouts compared with traffic signals.⁽¹⁴⁶⁾

Physical Impacts

Converting a signalized intersection to a roundabout requires sufficient right-of-way to accommodate the circumference of the roundabout. In many cases, construction of a roundabout in place of a traffic signal will require the acquisition of small amounts of right-of-way at the intersection. However, because roundabouts generally require fewer approach lanes than signalized intersections, in some cases existing travel lanes approaching the intersection can be converted to parking, bike lanes, or other uses. Roundabouts can also improve the esthetics of existing signalized intersections, including the addition of landscaping.

Socioeconomic Impacts

Converting a signalized intersection to a roundabout requires significant capital investment. However, roundabouts offer lower lifecycle costs compared with traffic signals, which require electrical power and maintenance of signal hardware (including detectors). Reduced vehicle delays and other operational benefits associated with roundabouts can lower vehicle operating costs (including fuel consumption) for motorists and transit agencies.

Summary

Exhibit 9-25 summarizes the issues associated with converting traffic signals to roundabouts.

Characteristic	Potential Benefits	Potential Disbenefits
Safety	Substantial reductions in all collisions and injury collisions.	None identified.
Operations	Substantial reductions in traffic delays and vehicle stops.	None identified.
Multimodal	Roundabouts generally are safer for pedestrians than traditional intersections.	Multi-lane roundabouts can be challenging for visually impaired pedestrians. Safety studies on bicyclists at roundabouts have mixed findings.
Physical	Esthetic improvement, including landscaping.	May require additional right-of-way.
Socioeconomic	Lower life cycle costs, vehicle operating costs (including fuel consumption) for motorists.	Requires significant capital investment.
Enforcement, Education, and Maintenance	Roundabouts require less maintenance than traffic signals.	Public information may be needed.

Exhibit 9-25. Summary of issues for converting traffic signals to roundabouts.

9.6.2 Convert Signalized Intersection to All-Way Stop Control

Description

All-way stop control requires vehicles approaching the intersection from all directions to stop prior to entering the intersection. Because of the large number of vehicle stops and delays associated with this form of control, its use is generally limited to residential areas and low-speed settings.

Applicability

Converting a signal to all-way stop control requires thoughtful analysis and consideration, as it is not a common practice. Before converting a signal to all-way stop control, the engineer should review the guidance in the MUTCD Part 2B.07.

Safety Performance

Researchers identified the effect on intersection crashes of converting nearly 200 one-way street intersections in Philadelphia from signal to all-way stop sign control.⁽¹⁵²⁾ Using crash and traffic volume data for a comparison group, regression models were computed to represent the normal crash experience of signal controlled intersections of one-way streets, by impact type, as a function of traffic volume. Estimates were obtained for different classes of crashes categorized by impact type, day/night condition, and impact severity. Aggregate results indicate that replacing signals by all-way stop signs on one-way streets is associated with a reduction in crashes of approximately 24 percent, combining all severities, light conditions, and impact types.

Treatment	Finding
Convert signalized intersection to multi-way stop. ⁽¹⁵²⁾	24 percent estimated reduction in all collisions. 25 percent estimated reduction in right-angle collisions. 17 percent estimated reduction in pedestrian collisions (46 percent reduction at night)

Exhibit 9-26. Safety effects associated with converting traffic signals to multi-way stop.

Operational Performance

By design, all-way-stop control generates considerable vehicle delay compared with traffic signal operation because all vehicles are required to stop before entering the intersection.

Multimodal Impacts

Conversion of signalized intersections to all-way stop control benefits pedestrians and bicyclists because of the low traffic speeds of motor vehicles in the vicinity of the intersection.

Physical Impacts

Conversion of signalized intersections to all-way stop control eliminates traffic signal poles, but introduces sign supports. Intersection sight distance differs depending on the type of intersection and maneuver involved. Signalized intersections require that drivers be provide with an unobstructed view of both the approach triangle and the departure triangle, whereas intersections controlled by all-way stop signs have no such requirements.⁽¹⁵³⁾

Socioeconomic Impacts

Conversion of signalized intersections to all-way stop control reduces costs required to electrify and maintain traffic signals. The cost of installing and maintaining multi-way stop signs is relatively low.

Summary

Exhibit 9-27 summarizes the issues associated with converting traffic signals to all-way stop control.

Characteristic	Potential Benefits	Potential Disbenefits
Safety	Reduced crashes.	None identified.
Operations	None identified.	Increased vehicle delay.
Multimodal	Benefits pedestrians and bicyclists because of the low traffic speeds of motor vehicles in the vicinity of the intersection.	None identified.
Physical	Eliminates traffic signal poles.	Requires installation of sign poles.
Socioeconomic	Reduces costs required to electrify and maintain traffic signals.	None identified.
Enforcement, Education, and Maintenance	Eliminates traffic signal maintenance.	Significant education will be required to share the signal removal decision with the public and public officials. The location may require periodic police enforcement of stop signs.

Exhibit 9-27. Summary of issues for converting traffic signals to all-way stop control.

CHAPTER 10

APPROACH TREATMENTS

TABLE OF CONTENTS

10.0	APPROACH TREATMENTS	10-2
10.1	Signal Head Placement and Visibility	10-2
10.1.1	Convert to Over-the-Road Signal Heads	10-3
10.1.2	Add Supplemental Signal Heads	10-4
10.1.3	Increase Size of Signal Heads	10-5
10.1.4	Increase Number of Signal Heads	10-7
10.1.5	Provide Backplates	10-9
10.1.6	Provide Advance Warning	10-10
10.2	Signing and Speed Control Treatments	10-12
10.2.1	Improve Lane Use and Street Name Signing	10-12
10.2.2	Reduce Operating Speed	10-14
10.3	Roadway Surface Improvements	10-14
10.3.1	Improve Pavement Surface	10-14
10.3.2	Improve Cross Section	10-17
10.3.3	Remove Obstacles from Clear Zone	10-19
10.4	Sight Distance Treatments	10-20
10.4.1	Improve Sight Lines	10-20
10.5	Dilemma Zone Detection	10-23
10.6	Red Light Camera Enforcement	10-25

LIST OF EXHIBITS

10-1	Summary of approach treatments	10-2
10-2	Safety benefits associated with using mast arms: selected findings	10-3
10-3	Summary of issues for using mast arm/span wire-mounted signal heads	10-4
10-4	Summary of issues for supplemental near-side traffic signal heads	10-5
10-5	Safety benefits associated with using 12-inch signal lenses: selected findings	10-6
10-6	Summary of issues for increasing the size of signal heads	10-7
10-7	Lane-aligned signal heads	10-7
10-8	Safety benefits associated with the addition of a signal head: selected findings	10-8
10-9	Summary of issues for adding a signal head	10-8
10-10	Summary of issues for using signal head backplates	10-10
10-11	Safety benefits associated with advance warning signs and flashers: selected findings	10-11
10-12	Summary of issues related to advance warning treatments	10-12
10-13	Safety benefits associated with advance lane-use signs: selected findings	10-13
10-14	Summary of issues for improving signing	10-14
10-15	Safety benefits associated with nonskid treatments, drainage improvements, or resurfacing: selected findings	10-16
10-16	Summary of issues for pavement treatments	10-17
10-17	Summary of issues for cross section improvements	10-19
10-18	Summary of issues for removing obstacles from the clear zone	10-20
10-19	Expected reduction in number of crashes per intersection per year by increased sight distance	10-21
10-20	Safety benefits associated with sight distance improvements: selected findings	10-22
10-21	Summary of issues for visibility improvements	10-23
10-22	Dilemma zone and detector placement	10-24
10-23	Vehicular distances traveled by speed	10-24
10-24	Summary of issues for dilemma zone detection	10-25
10-25	Summary of issues for red light cameras	10-27

10.0 APPROACH TREATMENTS

Approaches are critical signalized intersection components. Intersections and traffic control devices should be obvious to approaching motorists, bicyclist, and pedestrians. Adequate signing and pavement marking must provide the driver with sufficient information to determine the appropriate lane and direction to travel. The pavement on the approaches should provide the needed degree of friction for a turning maneuver or stop and adequate drainage. The approaches ideally should meet at right angles and should be at grade and free of unnecessary clutter and obstacles. Sight distance for all approaches should be adequate for drivers proceeding through the intersection, particularly those making a permissive left turn.

This chapter will discuss various treatments related to signalized intersection approaches, as summarized in Exhibit 10-1.

Approach Treatment Type	Treatment
Traffic control	Mast arm and span wire mounts Advanced warning flashers Dilemma zone protection Operating speed Extended lane line markings
Pavement/cross section improvements	Skid resistance Rumble strips Improved cross section Removal of obstacles Reduce intersection skew
Visibility	Near-side traffic signal heads Larger traffic signal heads Increase number of signal heads Backplates Adequate sight distance for conflicting turning movements, pedestrian crossings

Exhibit 10-1. Summary of approach treatments.

10.1 SIGNAL HEAD PLACEMENT AND VISIBILITY

Traffic signals should be placed so the signal heads are visible at a distance upstream of the intersection and from all lanes on the approach. Approaches with poorly placed traffic signals are likely to experience an increase of conflicts and collisions. At intersections with a higher proportion of heavy trucks, drivers in adjacent lanes or following a heavy vehicle may not be able to see the signal indication, which may lead to inadvertent red-light running. Some red-light runners claim they did not see the traffic signal, and one reason could be suboptimal placement of traffic signal heads or a failure to make the traffic signal head visually prominent.

Approach treatments that improve signal visibility help drivers make decisions at the intersection and alert them to the presence of a signalized intersection. Subsequently, the probability of driver error, such as inadvertently running a red light and being involved in a collision, is lower.

The following sections identify traffic control treatments that can be applied to improve the visibility of signal heads.

10.1.1 Convert to Over-the-Road Signal Heads

Description

Three major types of signal head placement are in popular use today: pedestal, span wire, or mast arm mounted. Chapter 5 discussed the merits and drawbacks of each. For a signalized intersection experiencing safety problems related to the placement or visibility of a pedestal-mounted signal head, the traffic engineer should consider either replacing signal heads or supplementing signal heads. Replacing or supplementing signal heads should be considered when:

- An approach where a pedestal-mounted traffic signal head is located against a backdrop with a considerable amount of visual clutter.
- An approach where heavy truck traffic habitually prevents adjacent and following drivers from viewing a pedestal-mounted traffic signal head.

Both mast arms and span wire mounted traffic signals improve the signal head's prominence upstream of the intersection.

Application

This treatment should be considered:

- At intersections where a high number of angle collisions occur that may be attributable to unintentional red-light runners.

Safety Performance

The safety impact of mast arm mounted signal heads relates to the conspicuity of the signal indications, especially in areas where there are competing visual distractions like on-site signing and lighting near the pedestal-mounted heads. Safety effects of signal upgrades from pedestal to mast arm are shown in Exhibit 10-2.

Treatment	Finding
Replace pedestals with mast arms, ⁽¹⁵⁵⁾	36 percent reduction for all crash types and severities. 47 percent reduction for severe injuries (all crash types) 13 percent reduction for minor injuries (all crash types) 72 percent reduction for right angle crashes (all severities) 20 percent increase in rear-end crashes (all severities) 2 percent increase in left turn crashes (all severities)

Exhibit 10-2. Safety benefits associated with using mast arms: selected findings.

Operational Performance

Signal head placement has a negligible effect on intersection capacity. However, centering signal heads over lanes can help drivers choose the proper lane to navigate through the intersection.

Multimodal Impacts

The placement of traffic signal heads on span wires or mast arms will be particularly advantageous for heavy vehicles, giving them additional time to decelerate and come to a full stop.

Physical Impacts

Span wire mounted signal heads have a constructability advantage over mast arm mounted signal heads. At larger intersections, the length of the mast arm may limit its use.

Socioeconomic Impacts

Span wire installations are generally considered less esthetically pleasing than mast arms because of overhead wires.

Enforcement, Education, and Maintenance

Span wire installations generally have higher ongoing maintenance costs than mast arms. Both types may need additional reinforcements if installed in a location known for strong winds.

Summary

Exhibit 10-3 summarizes the issues associated with using mast arm or span wire mounts for signal heads.

Characteristic	Potential Benefits	Potential Concerns
Safety	Increases signal visibility. Decreases collisions.	None identified.
Operations	Negligible effect.	None identified.
Multimodal	Heavy vehicles have more time to stop.	None identified.
Physical	Greater flexibility in placement of span wire poles.	Less flexibility in placement of mast arm poles.
Socioeconomic	None identified.	Span wires not aesthetically pleasing.
Enforcement, Education, and Maintenance	None identified.	Span wires typically require more maintenance than mast arms.

Exhibit 10-3. Summary of issues for using mast arm/span wire-mounted signal heads.

10.1.2 Add Supplemental Signal Heads

Description

Supplemental traffic signals may also be placed on the near side of the intersection, far-left, far-right, or very high. This may be particularly useful if:

- Sight distance is an issue, such as on approaches to intersections on horizontal and vertical curves.
- The intersection is particularly wide, so that a far-side signal cannot be placed within MUTCD sight distance requirements for approaching drivers.⁽¹⁾
- Auxiliary turn lanes are present.

Applicability

Supplemental head placements may be considered where there may be limited sight distance or at a particularly wide intersection where visibility of the signal indications could be a problem. Refer to the MUTCD for guidance on the location of signal heads.⁽¹⁾

Safety Performance

Supplemental traffic signal heads appear to reduce the number of fatal and injury collisions at an intersection, according to the limited research that has been done on their effectiveness at preventing collisions.

Operational Performance

When placed on the near side of an intersection, additional signal poles have a negligible effect on intersection capacity.

Multimodal Impacts

Near-side traffic signal placement on a median benefits heavy trucks by giving them additional warning.

The placement of the traffic signal should not interfere with the movement of pedestrians across the intersection or along the sidewalk.

Physical Impacts

As a pedestal traffic signal is mounted on the near side of an intersection, a median must be present in that location. This will likely incur additional costs to provide electricity and conduit to connect to the traffic controller. In other cases (far-left, far-right, or very high-mounted), the signal head can often be placed on an existing pole with access to conduit and power.

Summary

Exhibit 10-4 summarizes the issues associated with supplemental near-side traffic signal poles.

Characteristic	Potential Benefits	Potential Concerns
Safety	Increases signal visibility. Decreases angle collisions.	None identified.
Operations	Negligible.	None identified.
Multimodal	Heavy trucks have more time to stop.	May interfere with movement of crossing pedestrians.
Physical	None identified.	None identified.
Socioeconomic	None identified.	Moderate costs.
Enforcement, Education, and Maintenance	None identified.	None identified.

Exhibit 10-4. Summary of issues for supplemental near-side traffic signal heads.

10.1.3 Increase Size of Signal Heads

Description

Two diameter sizes are currently used for signal lenses: 8 inches and 12 inches. Of these, 12-inch signal faces for red, amber, and green indications are commonly used at medium- and high-volume intersections. Many jurisdictions are working to limit the use of 8-inch signal heads to only low-speed locations without confusing/complex backgrounds. The MUTCD indicates 12-inch signal faces shall be used for all signal sections in all new signal faces, with the following exceptions:⁽¹⁾

Eight-inch circular signal indications may be used in new signal faces only for:

- A. The green or flashing yellow signal indications in an emergency-vehicle traffic control signal;
- B. The circular indications in signal faces controlling the approach to the downstream location where two adjacent signalized locations are close to each other and it is not practical

because of factors such as high approach speeds, horizontal or vertical curves, or other geometric factors to install visibility-limited signal faces for the downstream approach;

- C. The circular indications in a signal face located less than 120 feet from the stop line on a roadway with a posted or statutory speed limit of 30 mph or less;
- D. The circular indications in a supplemental near-side signal face;
- E. The circular indications in a supplemental signal face installed for the sole purpose of controlling pedestrian movements rather than vehicular movements; and
- F. The circular indications in a signal face installed for the sole purpose of controlling a bikeway or a bicycle movement.

Existing 8-inch circular signal indications not included in items A through F may be retained for the remainder of their useful service life.

Application

Using 12-inch lenses should improve visibility for the driver, and as such may reduce red-light running and associated angle collisions.

Safety Performance

Srinivasan et al. (2008) conducted a before-after evaluation for four types of treatments at signalized intersections using data from Winston-Salem, NC. The result was an estimated 42 percent reduction in right-angle collisions and a 3 percent reduction in total collisions.⁽¹⁵⁶⁾ Another before-and-after study was undertaken to assess the effectiveness of larger (12 inches) and brighter signal head displays in British Columbia. Results from an EB analysis showed the frequency of total crashes was reduced by approximately 24 percent with the proposed signal displays. The results were found to be consistent with previous studies and laboratory tests that showed increased signal visibility results in shorter reaction times by drivers and leads to improved safety.⁽¹⁵⁷⁾

References regarding the safety benefits of installing 12-inch signal lenses are shown in Exhibit 10-5.

Treatment	Finding
Install 12-inch signal lenses, use higher wattage bulbs. ⁽¹⁵⁷⁾	24 percent estimated reduction in all collisions.
Install 12-inch signal lenses. ⁽¹⁵⁶⁾	42 percent estimated reduction in right angle collisions. 3 percent estimated reduction in all collisions.

Exhibit 10-5. Safety benefits associated with using 12-inch signal lenses: selected findings.

Operational Performance

None identified.

Socioeconomic Impacts

Using 12-inch lenses costs nominally more than using 8-inch lenses.

Summary

Exhibit 10-6 summarizes the issues associated with increasing the size of signal heads.

Characteristic	Potential Benefits	Potential Concerns
Safety	Reduction in collisions – particularly angle collisions.	None identified.
Operations	None identified.	None identified.
Multimodal	None identified.	None identified.
Physical	None identified.	None identified.
Socioeconomic	None identified.	Larger signal heads cost nominally more than smaller signal heads.
Enforcement, Education, and Maintenance	None identified.	None identified.

Exhibit 10-6. Summary of issues for increasing the size of signal heads.

10.1.4 Increase Number of Signal Heads

Description

The number of signal heads may be increased so one signal head is over each lane of traffic on an approach. Current MUTCD requirements for signal head placement state “a minimum of two signal faces shall be provided for the major movement on the approach, even if the major movement is a turning movement.”⁽¹⁾ In addition, at least one signal head must be not less than 40 ft beyond the stop line and not more than 180 ft beyond the stop line unless a supplemental near-side signal face is provided. Finally, at least one and preferably both of the signal faces must be within the 20-degree cone of vision.

Traffic signal heads on a mast arm typically located above each. Exhibit 10-7 shows an example of an approach with dual left-turn lanes, two through lanes, and a right-turn lane with lane-aligned signal heads.



Exhibit 10-7. Lane-aligned signal heads.

Application

Consider this treatment in situations where unusually high numbers of angle collisions occur because a vehicle runs a red light. Also, consider it at high speed intersections with fewer signal heads than approach lanes. This application may be a local or spot treatment, or may be part of a systematic improvement plan.

Safety Performance

A Canadian study evaluated the crash effects associated with additional primary signal heads and found a 28 percent decrease in all collisions, a 28 percent decrease in rear-end collisions, and a 35 percent reduction in angle collisions.⁽¹⁵⁸⁾

Exhibit 10-8 summarizes selected findings relating to the safety benefits of adding a signal head.

Treatment	Finding
Add a primary signal head. ⁽¹⁵⁸⁾	28 percent estimated reduction in all collisions.
	28 percent estimated reduction in rear-end collisions.
	35 percent estimated reduction in angle collisions.

Exhibit 10-8. Safety benefits associated with addition of a signal head: selected findings.

Operational Performance

None identified.

Socioeconomic Impacts

The capital cost of adding an extra signal head is minimal if the existing mounting and pole can be used. If a new mast arm and/or pole is required, for instance, the costs could be significant. Additional maintenance and electricity costs are incurred over time.

Summary

Exhibit 10-9 summarizes the issues associated with adding a signal head.

Characteristic	Potential Benefits	Potential Concerns
Safety	Reduction in collisions.	None identified
Operations	None identified.	None identified.
Multimodal	None identified.	None identified.
Physical	None identified.	May require new signal pole and foundation.
Socioeconomic	None identified.	Costs may be high if a new mast arm and pole is required.
Enforcement, Education, and Maintenance	None identified.	None identified.

Exhibit 10-9. Summary of issues for adding a signal head.

10.1.5 Provide Backplates

Description

Backplates are a common treatment for enhancing the signal head visibility. Backplates have a dull black finish to enhance the contrast between the signal head and its surroundings, and can include a strip of yellow retroreflective tape around the perimeter of the backplate.

Applicability

The MUTCD contains guidance pertaining to the use of backplates in Section 4D.12, Visibility, Aiming, and Shielding of Signal Faces. Backplates should be provided for the following situations

- Intersections with approach speeds 45 mph or higher.
- Sun glare, bright sky, and/or complex or confusing backgrounds indicate a need for enhanced signal face target value.

Backplates serve to increase the contrast between the signal head and its surroundings, drawing the attention of approaching drivers and therefore increasing the likelihood that they will stop on a red indication. They should be considered in situations where a high number of angle collisions occur.

Operational Features

Backplates with a yellow retroreflective strip around the outside edge highlight the presence of the traffic signal. This is an advantage particularly during power outages, and provides an additional benefit to drivers with a color vision deficiency (the shape of the signal is clear, helping a color deficient driver identify red-yellow-green by placement rather than color).

Safety Performance

A British Columbia study evaluated crash effects of installing yellow micro-prismatic retroreflective sheeting along the outer edge of backplates in an attempt to frame the signal heads and make them more visible to motorists.⁽¹⁵⁹⁾ The study found an estimated 15 percent reduction in all crashes.

Operational Performance

The use of backplates enhances the contrast between the traffic signal indications and their surroundings for both day and night conditions, which is also helpful to older drivers (MUTCD Section 4D.12).⁽¹⁾

Socioeconomic Impacts

The cost of installing signal backplates on a signal head is minimal. In addition, extra wind loading caused by backplates may necessitate larger (more costly) support poles for both span wires and mast arms.

Education, Enforcement, and Maintenance

Due to their larger size, signal heads with backplates may be more prone to movement during high winds. This may pose a problem if they are mounted on a span wire, leading to maintenance issues; however, there are designs available (e.g., vented backplates) to mitigate potential problems.

Summary

Exhibit 10-10 summarizes the issues associated with using signal head backplates.

Characteristic	Potential Benefits	Potential Concerns
Safety	Reduction in angle collisions.	None identified.
Operations	Benefit to Older Drivers	None identified.
Multimodal	None identified.	None identified.
Physical	None identified.	None identified.
Socioeconomic	None identified.	Minor cost for backplates and reflective tape. Possible increased pole cost for increased wind loads.
Enforcement, Education, and Maintenance	None identified.	None identified.

Exhibit 10-10. Summary of issues for using signal head backplates.

10.1.6 Provide Advance Warning

Description

These two treatments provide advance warning to motorists:

1. Provide a general warning of a signalized intersection ahead.
2. Provide a specific advance warning of an impending traffic signal change (from green to red) ahead.

Treatments that provide a general warning include static signs (SIGNAL AHEAD) and continuous advance-warning flashers. These flashers consist of a sign mounted on a pole with a yellow flashing light. The sign may read BE PREPARED TO STOP or show a schematic of a traffic signal. This type of flasher flashes regardless of what is occurring at the signal. Both treatments are placed upstream of the traffic signal at a distance sufficient to allow drivers time to react to the signal.

The second type of treatment provides a specific warning of an impending traffic signal change ahead. These advance-warning flashers inform drivers of the status of a downstream signal. This type is activated showing yellow flashing lights or illuminating an otherwise blank changeable message such as “Red Signal Ahead.”

The sign and the flashers are placed a certain distance from the stop line as determined by the speed limit on the approach.

Applicability

A SIGNAL AHEAD sign (possibly with an optional warning flasher) is required by the MUTCD in cases where the primary traffic control is not visible from a sufficient distance to permit the driver to respond to the signal. Warning flashers may be an effective countermeasure for:

- Rear-end collisions where a driver appears to have stopped suddenly to avoid running a red light and was struck from behind.
- Angle collisions caused by inadvertent red-light running.
- Queues from a red signal occurring at a location where approaching traffic cannot see it due to a vertical or horizontal curve.

Advance-warning flashers are appropriate for higher-speed, isolated intersections where the signalized intersection may be unexpected or where there may be sight distance issues. They

appear to be most beneficial in situations where the minor approach volumes exceed 13,000 AADT or greater.⁽¹⁶⁰⁾

Operational Features

A key factor in operating an advance-warning flasher is determining an appropriate time for coordinating the onset of flash with the onset of the yellow interval at the traffic signal. The recommended practice is to time the onset of flash as a function of posted speed for the distance from the flasher to the stop line. Timing the onset of flash for speeds greater than the posted speed encourages speeding to clear the intersection before the onset of the red interval.

Safety Performance

The introduction of advance-warning flashers on the approaches to a signalized intersection appears to be associated with a reduction in right-angle collisions.

Angle collisions were reduced by 35 percent at 11 signalized intersections where a SIGNAL AHEAD sign was installed on one or more approaches.⁽¹⁶¹⁾

A study conducted in Minnesota involving the installation of an advance-warning flasher on one approach found a 29 percent reduction in the number of red-light running events, in particular those involving trucks (63 percent). The study did not use a control or comparison group of intersection approaches.⁽¹⁶²⁾

Results from a study of 106 signalized intersections in British Columbia showed that intersections with advance-warning flashers have a lower frequency of crashes than similar locations without flashers. The results were not statistically significant at the 95th percentile confidence level. Benefits were found primarily for moderate-to-high traffic volumes on the minor approach.⁽¹⁶⁰⁾

Exhibit 10-11 shows selected references to safety benefits of advance-warning devices.

Treatment	Finding
Post SIGNAL AHEAD signs. ⁽¹⁶¹⁾	35 percent estimated decrease in angle collisions.
Advance-warning flasher ⁽¹⁶³⁾	8 percent estimated decrease in all crash types, all severities. 11 percent estimated decrease in injury crashes (all crash types) 43 percent estimated decrease in right angle crashes (all severities) 1 percent estimated decrease in rear-end crashes (all severities)

Exhibit 10-11. Safety benefits associated with advance warning signs and flashers: selected findings.

Operational Performance

Advance-warning flashers have no documented effect on intersection capacity.

Multimodal Impacts

Flashers may be particularly useful for larger commercial vehicles, which need a greater distance to stop on intersection approaches.

Socioeconomic Impacts

Advance-warning flashers that activate before the onset of the yellow phase may be costly to install.

Enforcement, Education, and Maintenance

Another study investigated the effect of advance flashing amber signs at two intersection approaches. Results showed that only a few drivers responded to the start of flashing by slowing down. The majority of vehicles increased their speed; many significantly exceeded the speed limit. Fifty percent of drivers who saw the flashing amber within the first 3 seconds it was displayed continued through the stop line. Driver education and police enforcement should be applied to ensure that drivers respond appropriately to signal-activated advance warning flashers.⁽¹⁶⁴⁾

Summary

Exhibit 10-12 summarizes the issues associated with advance warning treatments.

Characteristics	Potential Benefits	Potential Concerns
Safety	Decreases angle collisions.	May induce some drivers to try to beat the light.
Operations	Negligible effect.	None identified.
Multimodal	Heavy vehicles given more time to stop.	None identified.
Physical	None identified.	Activated advance-warning flashers require link to traffic controller at intersection.
Socioeconomic	Signing and continuous advance-warning flashers have low cost.	Activated advance-warning flashers have moderate costs.
Enforcement, Education, and Maintenance	None identified.	Enforcement may be needed to ensure compliance with the signal indications.

Exhibit 10-12. Summary of issues related to advance warning treatments.

10.2 SIGNING AND SPEED CONTROL TREATMENTS

10.2.1 Improve Lane Use and Street Name Signing

Description

For some intersections, the use of signs beyond the minimum required by the MUTCD may improve safety and/or operations.⁽¹⁾

Application

Signing treatments to consider at signalized intersections include:

- Increase the size of signs. Signs located on wide streets are more difficult to read from the far lane, and signs located overhead appear smaller to drivers and therefore need to be substantially larger than ground-mounted signs to have the same visibility.⁽⁶⁹⁾
- Use overhead lane-use signs. These provide improved visibility and may help correct a problem with sideswipe crashes on approach due to last-minute lane changes. These are especially important for treatments involving indirect turning movements that may violate driver expectation. In addition, ground-mounted signs may be less visible in a typical urban environment due to visual clutter.
- Use large street name signs on mast arms. These signs, either retroreflective or internally illuminated, are visible from a greater distance.

- Use advance street name signs.

Safety Performance

Advance lane-use signs may improve safety by reducing last-minute lane changes and better preparing drivers to watch for potential conflicts. One study in Winston Salem, NC based on limited data reported that advance signing reduced angle collisions by 35 percent.⁽¹⁶¹⁾ An evaluation of advance street name signs⁽¹⁶⁵⁾ estimated these devices were associated with a 10 percent reduction in sideswipe crashes.

Selected findings of safety benefits of other types of improved signing at signalized intersections are shown in Exhibit 10-13.

Treatment	Finding
Install larger signs. ⁽¹⁰¹⁾	15 percent decrease in all collisions.
Overhead lane-use signs. ⁽¹⁶⁶⁾	10 percent decrease in rear-end collisions. 20 percent decrease in sideswipe collisions.
Install advance warning signs. ⁽¹⁶¹⁾	35 percent estimated reduction in angle crashes.
Install advance street name signs. ⁽¹⁶⁵⁾	10 percent estimated reduction in sideswipe crashes.

Exhibit 10-13. Safety benefits associated with advance lane-use signs: selected findings.

Operational Performance

Advance lane-use signing may improve lane utilization at the intersection and therefore improve capacity if the affected movement is critical.

Physical Impacts

Sign supports are obstacles that could injure bicyclists, motorcyclists, pedestrians, and vehicle occupants.⁽⁶⁹⁾ Therefore, each sign should be carefully located to minimize the potential hazard. In addition, large advance signs can be difficult to locate in areas with tight right-of-way or where a sidewalk would be adversely affected by the sign or its support.

Socioeconomic Impacts

Low to moderate cost.

Summary

Exhibit 10-14 summarizes the issues associated with improving signing.

Characteristic	Potential Benefits	Potential Concerns
Safety	Various types of improved informational signing can reduce crashes.	None identified.
Operations	Advance signing may improve lane utilization and capacity of the intersection.	None identified.
Multimodal	None identified.	None identified.
Physical	None identified.	Sign supports must be designed to minimize potential hazard.
Socioeconomic	None identified.	Low to moderate cost.
Enforcement, Education, and Maintenance	None identified.	Added sign inventory to manage/maintain.

Exhibit 10-14. Summary of issues for improving signing.

10.2.2 Reduce Operating Speed

Excessive speed on an approach may lead to drivers' running a red light, braking suddenly to avoid a signal change, or losing control of the vehicle while attempting a left or right turn. Reducing the operating speed on an intersection approach cannot be accomplished through simply lowering the posted speed limit. Research suggests that drivers use the road and the surrounding road environment in choosing the operating speed of their vehicle, as opposed to a posted speed limit.

Possible countermeasures to reduce vehicles' operating speed include landscaping, rumble strips, medians, narrow travel lanes, bike lanes, on-street parking, curb radii reductions, and automated speed enforcement. Several of these treatments are discussed elsewhere in the guide; the reader is encouraged to refer to those sections for more information.

10.3 ROADWAY SURFACE IMPROVEMENTS

10.3.1 Improve Pavement Surface

Description

An important objective of highway design objective is ensuring that pavement provides sufficient friction and provides for adequate drainage. A polished pavement surface, a surface with drainage problems, or a poorly maintained road surface can contribute to crashes at or within intersections. Within an intersection, the potential for vehicles on adjacent approaches to be involved in crashes contributes to the likelihood of severe (angle) crashes, particularly in crashes where the driver is unable to stop in time.

Water can accumulate on pavement surfaces due to rutted wheel paths, inadequate crowns, and poor shoulder maintenance. These problems can also cause skidding crashes and should be treated when present. While there is only limited research on such site-specific programs, the results provide confidence that pavement improvements are effective in decreasing crashes related to wet pavement. The effectiveness will vary with respect to location, traffic volume, rainfall intensity, road geometry, temperature, pavement structure, and other factors.

Vehicles often experience difficulties in coming to a safe stop at intersections because of reduced friction on wet or slippery pavement. A vehicle will skid during braking and maneuvering

when frictional demand exceeds the friction force that can be developed between the tire and the road surface; friction is greatly reduced on a wet and slippery surface, which has 20 to 30 percent less friction than a dry road surface.⁽¹⁶⁷⁾

Water pooling on or flowing across the roadway can prevent smooth operation of an intersection if vehicles are forced to decelerate or swerve in order to proceed safely through the intersection. It is necessary to intercept concentrated storm water at all intersection locations before it reaches the highway and to remove over-the-curb flow and surface water without interrupting traffic flow or causing a problem for vehicle occupants, pedestrians, or bicyclists. Improvements to storm drainage may be needed to improve intersection operations and safety. Potholes, if present on an approach, increase the likelihood of drivers' swerving or braking to avoid damage to their vehicles. A rough surface may also allow water to pool, and in colder environments, can cause ice to form on an intersection approach.

Proper drainage and a high-quality surface will prevent problems related to pooled water and lack of skid resistance. Skid resistance is an important consideration in pavement design, and polished pavement surfaces should be addressed to reduce the potential for skidding. Both vehicle speeds and pavement condition affect the surface's skid resistance. Improving the pavement condition, especially for wet weather conditions, can be accomplished by providing adequate drainage, grooving existing pavement, or overlaying existing pavement.

Improvements to pavement condition should have high initial skid resistance, ability to retain skid resistance with time and traffic, and minimum decrease in skid resistance with increasing speed.

Applicability

Improvements related to skid resistance, drainage problems, and pavement surface should be considered when:

- A high number of wet road surface collisions occur.
- Angle collisions occur and many involve one or more vehicles' skidding into the intersection and striking another vehicle.
- Single vehicle collisions occur where the driver lost control due to skidding.
- Rear-end or sideswipe collisions occur when drivers swerve or brake to avoid potholes or puddles.
- Change in type of control.

Safety Performance

Several pavement treatments appear to reduce collisions, although the study locations for the following findings of effectiveness were not necessarily signalized intersections. A 2010 California study reported that resurfacing with grooved pavement reduced wet road crashes by 50 percent, but results were not significant due to the lack of sufficient data.⁽¹⁶⁸⁾ Grooves carry off water from the road surface and increase the coefficient of friction between tires and pavement. The same study found that resurfacing with open-graded asphalt concrete significantly decreased the number of wet-related collisions by 42 percent. Another paper describes a non-carbonate surface treatment used at a wide range of sites as part of a comprehensive Skid Accident Reduction Program. Wet pavement collisions dropped by 61 to 82 percent; fatal and injury wet pavement collisions dropped by 73 to 84 percent.⁽¹⁶⁹⁾ Apart from addressing wet road surface collisions, resurfacing the approaches to an intersection will likely reduce the number of rear-end or sideswipe collisions caused when vehicles swerve or slow to avoid potholes. It may, however, lead to a higher operating speed and an overall shift in the collision profile toward collisions of greater severity.

Exhibit 10-15 shows the safety benefits associated with nonskid treatments, drainage improvements or resurfacing.

Treatment	Finding
Groove pavement. ⁽¹⁶⁸⁾	50 percent estimated reduction in wet pavement collisions.
Resurface with open-graded asphalt concrete. ⁽¹⁶⁸⁾	42 percent estimated reduction in wet pavement collisions.
Overlay pavement. ⁽¹⁷⁰⁾	27 percent estimated reduction in all collisions. 29 percent estimated reduction in fatal collisions. 16 percent estimated reduction in injury collisions. 32 percent estimated reduction in PDO collisions.
Resurface. ⁽¹⁷¹⁾	5 percent estimated reduction in fatal/serious injury collisions. 1 percent estimated increase in all collisions.
Improve pavement friction (increase skid resistance).	40 to 78 percent estimated reduction in wet road crashes
Improve pavement texture. ⁽¹⁷²⁾	5 percent estimated reduction in all collisions.
Noncarbonate surface treatment. ⁽¹⁶⁹⁾	61 to 82 percent estimated reduction in wet pavement collisions. 73 to 82 percent estimated reduction in fatal/injury collisions on wet pavement.
Drainage improvement. ⁽¹⁰¹⁾	20 percent estimated reduction in all collisions.

Exhibit 10-15. Safety benefits associated with nonskid treatments, drainage improvements, or resurfacing: selected findings.

Operational Performance

A pavement in poor condition can result in lower saturation flow rates and, consequently, reduce the capacity of the intersection. If vehicles need to proceed at slow speeds through an intersection or deviate from the travel path to avoid potholes, pooled water, or ice, operations likely will degrade.

Pavement resurfacing and drainage improvements usually improve intersection operations, although no known research conclusively indicates the expected capacity benefit of these treatments.

Multimodal Impacts

If road improvements are being carried out, sidewalks and bike paths adjacent to the intersection should be considered for skid-resistant treatments, checked for adequate drainage, and repaired if uneven surfaces exist due to cracking, frost heaves, etc. This will reduce pedestrian tripping hazards and the likelihood of bicyclists' swerving into traffic to avoid potential roadside hazards.

Enforcement, Education, and Maintenance

Pavement improvements (particularly resurfacing) may convey the message to drivers that they can now travel at higher speeds. Speeds on the approaches to the intersection should be monitored to ensure that the speed profile has not increased significantly in the post-implementation period. If speed has increased significantly and this is leading to degradation in safety, speed enforcement should be considered.

Summary

Exhibit 10-16 summarizes the issues associated with pavement treatments.

Characteristic	Potential Benefits	Potential Concerns
Safety	Wet-weather collisions reduced. Angle collisions due to skidding reduced. Rear-end/sideswipe collisions due to swerving/braking reduced.	Higher speed profile is a possible byproduct.
Operations	Improved traffic flow, less swerving.	None identified.
Multimodal	None identified.	None identified.
Physical	No additional requirements.	None identified.
Socioeconomic	None identified	Moderate to high costs associated with improvements.
Enforcement, Education, and Maintenance	None identified.	Enforcement may be needed to control speeds.

Exhibit 10-16. Summary of issues for pavement treatments.

10.3.2 Improve Cross Section

Description

Roadways should intersect on as flat a grade as possible to prevent difficulty in vehicle handling, especially when vehicles will likely need to wait for their turn to enter the intersection (as with left-turn lanes). However, it is not always feasible to design a level intersection, so consideration should be given to the profiles of the roadways as they intersect. Practitioners should examine roadway profiles and crowns to determine whether the intersection of these slopes contributes to vehicle handling difficulties. Generally, the pavement of the minor road is warped so that the crown is tilted to the same plane as the major road profile. Another option is to flatten the cross sections of both roadways so that they are each inclined to intersect with the profile of the other road. This method can create a large, flat roadway area, which in turn can lead to drainage problems; therefore, this design should only be used on smaller intersections or where the drainage problem can be solved. A third option involves maintaining constant cross sections on both roadways, and altering the centerline profiles to provide smooth pavement. This is a less desirable option than the previous two discussed, given that drivers from both directions must pass over three grade breaks at the intersection.⁽³⁾

In addition to the benefits to vehicles, pedestrians and bicyclists benefit from improvements to the cross section of an intersection. Severe grades and cross slopes can be difficult for bicyclists and pedestrians to negotiate. For example, flatter uphill grades allow bicyclists to more easily accelerate from a complete stop. Low cross slopes of no more than 2 percent are essential for pedestrians with mobility impairments per ADAAG, as severe cross slopes can make a roadway inaccessible.⁽³⁶⁾

Application

This treatment may be applicable at intersections where the grades of intersecting roads are greater than 3 percent and one or both of the following is true:

- A high number of rear-end collisions are occurring due to driver hesitation on the approaches and while making left or right turns.
- A high number of left-turn collisions are occurring due to poor sight distance.

Safety Performance

The cross section improvements discussed above will improve sight distance, and therefore should decrease left-turn conflicts with through vehicles. It will also allow a more uniform operating speed through the intersection on the major road approaches, reducing rear-end conflicts.

Operational Performance

The cross section improvements discussed above may reduce the time headway between vehicles and increase the capacity of the intersection.

Multimodal Impacts

Larger commercial vehicles and transit buses will particularly benefit from cross section improvements to the intersection. During any intersection reconstructing, the engineer should consider improvements to the adjacent sidewalks if pedestrian facilities exist and are being used.

Socioeconomic impacts

Cross section improvements may have moderate costs. They may be difficult to implement in areas where there is little or no right-of-way. Coordination with adjacent landowners may be needed.

Education, Enforcement, and Maintenance

Cross section improvements may convey the message that drivers can now travel at higher speeds. Speeds on the approaches to the intersection should be monitored to ensure that the speed profile has not increased significantly in the post-implementation period. If speed has increased significantly and this leads to safety problems, consider police speed enforcement. Note that cross section improvements on hilly roadways may actually result in reduced speeds.

The effectiveness of this treatment will likely be enhanced if performed in conjunction with a comprehensive and timely winter road maintenance program in colder climates.

Summary

Exhibit 10-17 summarizes the issues associated with cross section improvements.

Characteristic	Potential Benefits	Potential Concerns
Safety	Decrease in rear-end collisions due to driver braking. Decrease in left-and right-turning collisions involving inadequate sight distance.	Higher speed profile.
Operations	Better traffic flow.	None identified.
Multimodal	Improved driver handling of large trucks and transit. Sidewalks and curb ramps will be made more accessible by retrofitting to new cross section.	None identified.
Physical	None identified.	Significant right-of-way requirements.
Socioeconomic	None identified.	Moderate costs.
Enforcement, Education, and Maintenance	None identified.	Speed enforcement may be necessary. Winter maintenance may be needed.

Exhibit 10-17. Summary of issues for cross section improvements.

10.3.3 Remove Obstacles from Clear Zone

Description

Roadside objects can be a particular hazard to motorists on high-speed approaches. Utility poles, luminaires, traffic signal poles, bus shelters, signs, and other street furniture should be moved back from the edge of the road if possible. In general, a signalized intersection and the entire area within the right-of-way should be kept free of visual clutter, particularly illegally placed commercial signs.

Application

For high speed approaches at rural intersections, obstacles should be routinely removed from the clear zone on intersection approaches. Removing objects should be considered an immediate priority when:

- An unusually high number of run-off-the-road injury and fatal collisions involving roadside obstacles occurs.
- There is evidence in the collision police report that drivers claim distraction by unnecessary or illegally placed signing or other visual clutter.

Poles and other hardware that cannot be removed could be shielded from impact by errant vehicles.

For urban, low-speed environments, the right-of-way is often limited. It may not be practical to establish a full-width clear zone. Types of obstructions that may be located near signals could be fire hydrants, signs, utility poles, transit facilities, and luminaire supports. Obstacles should be located far enough away from the shoulder and curb to accomplish the following:

- Avoid adverse impacts on vehicle lane position and encroachments into other lanes.
- Improve sight distance for all users at the signal.
- Reduce the travel lane encroachments from occasional parked and disabled vehicles.
- Minimize contact between obstacles and vehicles.

The practitioner should relocate objects a minimum of 4 feet and at least 6 feet where feasible under these conditions. Other considerations can be found in the Roadside Design Guide.⁽⁶²⁾

Safety Performance

This treatment should decrease the frequency and severity of run-off-the-road collisions involving roadside obstacles. An Ohio study on roadside safety treatments estimated that removing or relocating fixed objects outside of the clear zone was associated with a 38 percent reduction in fatal and injury crashes.⁽¹⁷³⁾ This study was not limited to intersections.

Physical Impacts

Moving objects further away from the roadside may be difficult to implement in built-up areas where right-of-way is limited. Studies have shown under urban conditions that a minimum offset from curbs of 4 ft and, if possible, a distance of 6 ft can reduce fixed object crashes. For buffer areas between sidewalks and curbs, the practitioner should only allow posts with frangible bases.⁽¹⁷⁴⁾

Enforcement, Education, and Maintenance

Traffic engineers should coordinate with their equivalents in the planning department and maintenance staff to ensure that the entire right-of-way surrounding the intersection and its approaches stays free of obstacles and extraneous signing.

Summary

Exhibit 10-18 summarizes the issues associated with removing obstacles from the clear zone.

Characteristic	Potential Benefits	Potential Concerns
Safety	Reduction in the number and severity of single-vehicle collisions.	None identified.
Operations	None identified.	None identified.
Multimodal	None identified.	None identified.
Physical	--	Obstacle removal may be difficult in built-up areas with limited right-of-way.
Socioeconomic	None identified.	None identified.
Enforcement, Education, and Maintenance	--	Ongoing maintenance will be needed to ensure that the clear zone remains free of obstacles.

Exhibit 10-18. Summary of issues for removing obstacles from the clear zone.

10.4 SIGHT DISTANCE TREATMENTS

10.4.1 Improve Sight Lines

Description

Adequate sight distance for drivers contributes to the safety of the intersection. In general, left-turning vehicles need sight distance to see opposing through vehicles approaching the intersection in situations where a permissive left-turn signal is being used. Also, where right turns on red are permitted, right-turning vehicles need adequate sight distance to view vehicles approaching from the left on the cross street, as well as opposing vehicles turning left onto the cross street. AASHTO's *A Policy on Geometric Design of Highways and Streets* recommends providing adequate sight distance for all movements at signalized intersections where the signal operates on flash at times.⁽³⁾

Sight distance at signalized intersections should:

- Provide drivers making permissive left-turning movements need enough sight distance to judge on-coming traffic.
- Provide clear sight lines to all signal faces.
- Provide clear sight lines at pedestrian crosswalks.
- Provide clear sight lines at bike lanes and other bicycle facilities or treatments.
- Have sight distance at or above the above the minimums used in the AASHTO Green Book when placed on flash for emergencies.

Carefully consider landscaping at signalized intersections; it could prevent motorists from making left and right turns safely due to inadequate sight distances. Practitioners should ensure that traffic signs, pedestrian crossings, and nearby railroad crossing and school zones are not obstructed. Median planting of trees or shrubs greater than 2 ft in height should be well away from the intersection (more than 50 ft). No plantings having foliage between 2 ft and 8 ft in height should be present within sight triangles. Low shrubs or plants not exceeding a height of 2 ft are appropriate on the approaches to a signalized intersection, either on the median, or along the

edge of the roadway. The 1990 FHWA Guide, *Vegetation Control for Safety: A Guide for Street and Highway Maintenance Personnel*, provides additional guidelines and insight on vegetation control with regard to sight distance issues.⁽⁸⁷⁾

Application

Visibility improvements at signalized intersections should be considered when:

- Inadequate sight distance exists between vehicles and/or pedestrian. Any obstructions that limit sight distance of any types of users should be removed or relocated. A high number of left- and right-turn collisions are occurring.

Safety Performance

Crashes related to inadequate sight distance (specifically, angle- and turning-related) would be reduced if sight distance problems were improved. Intersections with sight distance problems will experience higher collision rates.⁽¹⁵⁷⁾ Older drivers are likely to have problems at intersections with limited sight distances, as they may need more time to perceive and react to hazards. Exhibit 10-19 shows the expected reduction in number of collisions per intersection per year, based on an FHWA report.⁽¹⁷⁵⁾

AADT* (1000s)	Increased Sight Distance		
	20 ft–49 ft	50 ft–99 ft	> 100 ft
< 5	0.18	0.20	0.30
5-10	1.00	1.30	1.40
10-15	0.87	2.26	3.46
> 15	5.25	7.41	11.26

* Annual average daily traffic entering the intersection

Exhibit 10-19. Expected reduction in number of crashes per intersection per year by increased sight distance.⁽¹⁷⁵⁾

A report by FHWA cites sight distance improvements as being one of the most cost-effective treatments (see Exhibit 10-20). Fatal collisions were reduced by 56 percent and nonfatal injury collisions were reduced by 37 percent at intersections having sight distance improvements.⁽¹⁷⁶⁾ The Handbook of Road Safety measures estimates that increasing triangle sight distance is associated with a 48 percent reduction in injury crashes, and an 11 percent reduction in property damage crashes.⁽¹⁴⁵⁾ However, these results include both signalized and unsignalized intersections.

Treatment	Implication
Sight distance improvements. ⁽¹⁷⁶⁾	56 percent estimated reduction in fatal collisions. 37 percent estimated reduction in injury collisions.
Sight distance improvements. ⁽¹⁴⁵⁾	48 percent estimated reduction in injury crashes. 11 percent estimated reduction in property damage crashes.

* Note: these crash results include both signalized and unsignalized intersections

Exhibit 10-20. Safety benefits associated with sight distance improvements: selected findings.

Socioeconomic Impacts

Sight distance improvements can often be achieved at relatively low cost by clearing sight triangles of vegetation or roadside appurtenances.

The most difficult aspect of this strategy is the removal of sight restrictions located on private property. The legal authority of highway agencies to deal with such sight obstructions varies

widely, and the time (and possibly the cost) to implement sight distance improvements by clearing obstructions may be longer if those obstructions are located on private property than if they are on public property. If the object is mature trees or plantings, then environmental issues may arise. Larger constructed objects (i.e., bus shelters, buildings) may not be feasibly removed. Consider other alternatives in these situations.

Multimodal Impacts

The appropriate use of landscaping can visually enhance a road and its surroundings. Landscaping may act as a buffer between pedestrians and motorists and reduce the visual width of a roadway, serving to reduce traffic speeds while providing a more pleasant environment. However, landscaping should not interfere with the movement of pedestrians along sidewalks, nor should it block the motorist's view of the pedestrian, or the pedestrian's view of the motorist.

Enforcement, Education, and Maintenance

All plantings should have an adequate watering and drainage system, or should be drought resistant. This will minimize the amount of maintenance required and reduce the exposure of maintenance staff to traffic. Plantings should not be allowed to obstruct pedestrians at eye height or overhang the curb onto the pavement.

Summary

Exhibit 10-21 summarizes the issues associated with visibility treatments.

Characteristics	Potential Benefits	Potential Concerns
Safety	Left- and right-turning collisions involving inadequate sight distance.	None identified.
Operations	Negligible.	None identified.
Multimodal	Provides additional warning for heavy vehicles making left and right turns. Appropriate landscaping will provide a more pleasant environment for pedestrians.	None identified.
Physical	None identified.	May be significant right-of-way requirements.
Socioeconomic	Appropriate landscaping will visually enhance intersection and surroundings.	None identified.
Enforcement, Education, and Maintenance	None identified.	Landscaping may require extensive maintenance.

Exhibit 10-21. Summary of issues for visibility improvements.

10.5 DILEMMA ZONE DETECTION

Description

On a high-speed approach to a signalized intersection there is a length of roadway in advance of the intersection, commonly referred to as the "dilemma zone," wherein drivers may be indecisive and respond differently to the onset of the yellow signal. When in the dilemma zone at the onset of yellow, some drivers may stop abruptly, while others may decide not to stop and perhaps even accelerate through the intersection. Such variation in driver behavior is conducive to the occurrence of rear-end, right-angle, and left-turn collisions. A dilemma zone detection system uses pulse (or advanced) detectors placed at one or more locations on the intersection

approach to extend the green and prevent the onset of yellow while approaching vehicles are in the dilemma zone (see Section 5.5.1).

The current state of the practice includes two typical installations:

1. Basic detection/actuation to increase the probability of gap-outs and reduce max-outs to improve both safety and operations.
2. Detection systems that take more dynamic control, extending all-red time if the system detects that a driver will likely run the red light.

As shown in Exhibit 10-22, some States use a rule of thumb of 5 seconds in advance of the stop line to provide dilemma zone protection. On very high speed routes, an additional set of detectors may be placed 8 seconds from the stop line. Exhibit 10-23 illustrates the distance traveled by vehicles at various speeds.

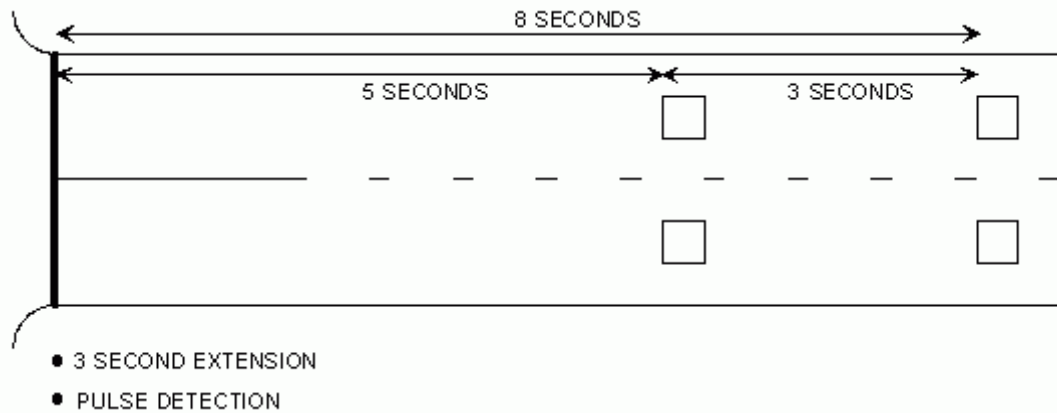

Exhibit 10-22. Dilemma Zone and detector placement.⁽⁶³⁾

Exhibit 10-23. Vehicular distances traveled by speed.^(Adapted from 63)

Speed (mph)		Time (s)	
mph	fps	5	8
		Distance Traveled (ft)	
5	7.3	37	59
10	14.7	73	117
15	22.0	110	176
20	29.3	147	235
25	36.7	183	293
30	44.0	220	352
35	51.3	257	411
40	58.7	293	469
45	66.0	330	528
50	73.3	367	587
55	80.7	403	645
60	88.0	440	704
65	95.3	477	763
70	102.7	513	821
75	110.0	550	880
80	117.3	587	939

Application

Dilemma zone detection systems apply to high-speed signalized intersections, often located in rural or suburban areas. This treatment (more specifically, a dynamic type control) is especially useful on high-speed approaches with heavy volumes of large trucks.

Safety Performance

An evaluation of a dilemma zone detection system developed for the Texas Department of Transportation estimated that red light violations were reduced by 58 percent, heavy vehicle red light violations were reduced by 80 percent, and severe crash frequency was reduced by 39 percent.⁽¹⁷⁷⁾

Operational Performance

The dilemma zone detection system developed for the Texas Department of Transportation was associated with a 14 percent reduction in approach delay and a 9 percent reduction in stop frequency. Other dynamic detection system designs for protection achieve similar operational improvements.

Multimodal Impacts

Large trucks and tour buses, which require longer stopping distances than passenger vehicles, especially benefit from the use of dilemma zone detection.

Socioeconomic impacts

Reductions in approach delay, heavy vehicle braking, and injury crashes provide economic benefits. Significant initial costs are associated with design and implementation of dilemma zone detection systems.

Education, Enforcement, and Maintenance

Traffic signal maintenance technicians may require additional training on technical aspects of dilemma zone detection systems.

Summary

Exhibit 10-24 summarizes the issues associated with the application of dilemma zone detection.

Characteristics	Potential Benefits	Potential Concerns
Safety	Reduced red-light running and injury crashes.	None identified.
Operations	Reduced approach delay and stop frequency.	None identified.
Multimodal	Especially useful for large trucks.	None identified.
Physical	None identified.	Possible disturbance to ROW and/or pavement surface.
Socioeconomic	Economic benefits from reductions in approach delay, heavy vehicle braking, and injury crashes.	Significant initial costs for design and implementation.
Enforcement, Education, and Maintenance	None identified.	Traffic signal technicians may require additional training for maintenance of installed equipment.

Exhibit 10-24. Summary of issues for dilemma zone detection

10.6 RED LIGHT CAMERA ENFORCEMENT

Description

Red light cameras automatically photograph vehicles whose drivers run red lights. The cameras are connected to the traffic signal and to sensors monitoring traffic flow just before the crosswalk or stop line. Vehicles that do not stop during the red phase are photographed. Depending on the particular technology, the system captures a series of photographs and/or a video clip showing the red light violator prior to entering the intersection on a red signal, as well as the vehicle's progression through the intersection. Cameras record the date, time of day, time elapsed since the beginning of the red signal, vehicle speed, and license plate. Tickets typically are mailed to owners of violating vehicles, based on a review of photographic evidence.

Application

Red light cameras are typically deployed at specific approaches to urban and suburban intersections with histories of red-light running crashes. Red light cameras may be especially useful on approaches where police officers have difficulty conducting traditional red light enforcement due to constrained environments and/or high traffic speeds.

It is vital to put public safety first in decisions regarding enforcement of traffic laws, including an emphasis on non-automated enforcement alternatives where applicable.⁽¹⁷⁸⁾ Note that other infrastructure treatments should be considered before automated red light enforcement, including the following:

- Updating signal timing to reflect current traffic conditions.
- Updating clearance timing per recommended practice.
 - Ensuring that clearance timing practice does not vary between State and local agencies in a region.
- Clearing sight lines to signal heads.
- Signing in advance of the intersection.
- Installing advance, signal-activated warning flashers.
- Installing reflectorized backplates.

Safety Performance

In NCHRP Report 729: *Automated Enforcement for Speeding and Red Light Running* three of the four case studies included information on safety performance:⁽¹⁷⁹⁾

- The program in the city of Portland, Oregon, resulted in a 69 to 93 percent reduction in red-light running violations.
- The program in the city of Virginia Beach, Virginia, reduced red light violations more than 69 percent over a 13 month period since the activation of the red light cameras.
- An audit of the program in the city of San Diego, California, found an 8 percent reduction in crashes from red-light running and a 16 percent reduction in red-light running related crashes at the specific signals with cameras. The city has initiated many changes to the program since completion of the audit.

Some studies, including FHWA's Safety Evaluation of Red Light Cameras,⁽²⁰⁷⁾ have reported reductions in angle crashes along with increases in rear end crashes, resulting in a net decrease in aggregate crash severity. The *Highway Safety Manual*⁽¹¹⁾ (Chapter 14) includes crash modification factors for red light cameras that indicate a 26 percent reduction in angle crashes and an 18 percent increase in rear-end crashes. However, NCHRP Report 729 concluded that the overall impact on violations and crashes related to a red light enforcement program needs further study.

Operational Performance

No operational performance measures have been reported for this treatment. However, changes to signal timing, detector settings, and other components of the intersection must be communicated to the division responsible for overseeing the red light program. As these adjustments are made, changes to the red light cameras can be made to ensure proper operation.

Multimodal Impacts

Pedestrians and bicyclists are vulnerable to impacts from motor vehicles that run red lights, and thus stand to benefit from reductions in red-light running behavior.

Socioeconomic impacts

A successful red light camera program will modify driver behavior in order to achieve a decrease in severe crashes associated with red-light running. The citations generated from red light cameras will result in fines and fees, which should be distributed in accordance with the state laws and/or local ordinances. In most cases, the citation fines and fees may be used to offset the cost of the red light camera program, with any excess monies used expressly for other road safety purposes.

The judiciary is critical to a successful red light camera program from the development of legislation to the choice of camera right down to the processing of violations. It is therefore important to get them involved as early on in the process as possible and for the judiciary to champion the effort. Another reason to involve them is to ensure that they are prepared to support the prosecution of the issued tickets when the red light camera system is activated.⁽¹⁸⁰⁾

Education, Enforcement, and Maintenance

A key component in developing a new enforcement program is informing and educating the public about the program, especially the purpose, the camera locations, the process for adjudication of citations, the use of revenue, and results of program evaluation in terms of effect on violations and crashes. In addition to conducting a public information campaign, a jurisdiction should consider assessing public support prior to, and during, implementation of the program.

Summary

Exhibit 10-25 summarizes the issues associated with red light cameras

Characteristics	Potential Benefits	Potential Concerns
Safety	Reduced red-light running and angle crashes.	Increased rear-end crashes.
Operations	None identified.	Changes to signal timing must be addressed when an agency installs red light cameras.
Multimodal	Pedestrians and bicyclists benefit from reduced red-light running.	None identified.
Physical	None identified.	Additional equipment installed along the roadside.
Socioeconomic	Fines generated by citations typically cover the cost of camera installation and operation	Fine revenue in excess of program operating costs can be a source of controversy.
Enforcement, Education, and Maintenance	Enforcement should be accompanied by public information and education.	Maintenance of installed equipment.

Exhibit 10-25. Summary of issues for red light cameras.

Chapter 11

INDIVIDUAL MOVEMENT TREATMENTS

TABLE OF CONTENTS

11.0	Individual Movement Treatments.....	11-3
11.1	Left-Turn Treatments	11-3
11.1.1	Add Single Left-Turn Lane	11-3
11.1.2	Multiple Left-Turn Lanes	11-15
11.2	Right-Turn Treatments	11-18
11.2.1	Channelizing Islands	11-18
11.2.2	Right-Turn Lanes	11-23
11.2.3	Provide Double Right-Turn Lanes.....	11-28
11.2.4	Restricting Turns, U-Turns.....	11-30
11.2.5	Provide Auxiliary Through Lanes	11-31
11.2.6	Delineate Through Path	11-34
11.3	Variable Lane Use Treatments	11-36
11.3.1	Provide Reversible Lanes	11-36
11.3.2	Provide Variable Lane Use Assignments	11-37

LIST OF EXHIBITS

11-1	Diagram of a single left-turn lane.....	11-4
11-2	Rule-of-thumb intersection capacities assuming various exclusive left-turn treatments ..	11-5
11-3	Narrow left-turn lanes may be used effectively in retrofit situations	11-6
11-4	Illustration of negative, no, and positive offset left-turn lanes.....	11-7
11-5	Example of positive offset left-turn lane.....	11-8
11-6	Guidelines for use of left-turn phasing	11-10
11-7	Guidelines for selection of type of left-turn phasing.....	11-11
11-8	Minimum recommended sight distance for allowing permissive left turns.....	11-12
11-9	Safety benefits associated with left-turn lane improvements for four approach, urban and suburban intersection	11-12
11-10	Crash effects of modifying left-turn phases	11-13
11-11	Summary of issues for left-turn lanes	11-14
11-12	Safety benefits associated with double left-turn lanes: selected findings.....	11-17
11-13	Summary of issues for multiple left-turn lanes.....	11-18
11-14	Channelized islands.....	11-19
11-15	Example illustration of a channelized right-turn lane	11-21
11-16	Safety benefits associated with right-turn channelization: selected findings.....	11-22
11-17	Summary of issues for channelized right-turn lanes	11-23
11-18	Diagram of a typical right-turn lane	11-24
11-19	Right-turn lane volume warrants	11-25
11-20	Narrow (8 ft) right-turn lanes may be used effectively in retrofit situations	11-26
11-21	Safety benefits associated with right-turn improvements	11-27
11-22	Summary of issues for right-turn lanes	11-28
11-23	Summary of issues for double right-turn lanes	11-30
11-24	Summary of issues for turn prohibitions.....	11-31
11-25	Diagram of an auxiliary through lane	11-32
11-26	Summary of issues for auxiliary through lanes	11-34
11-27	Example of delineated paths	11-35
11-28	Summary of issues for path delineation	11-36
11-29	Summary of issues for reversible lanes.....	11-37

11-30 Example use of variable lane use sign to add a third left-turn lane during certain times
of day 11-38

11-31 Example use of variable lane use sign to add a second right-turn lane along a corridor
during certain times of day 11-39

11-32 Summary of issues for variable lane use 11-39

11.0 INDIVIDUAL MOVEMENT TREATMENTS

This section identifies treatments for vehicle movements at signalized intersections. This section will start with left- and right-turn lanes, including multiple turning lanes. Relocating or prohibiting movements will be the next treatment discussed. Information related to through lane treatments will follow. Finally, this chapter will cover treatments to be used sparingly, but are available in response to unusually heavy traffic conditions (e.g., variable and reversible lane usage). The treatments in this section primarily address the following safety and operational concerns facing practitioners:

- Choosing appropriate treatment that addresses common crash types at signals.
- Impacts to all users are considered when choosing a treatment.
- An intersection that operates with nominal delay and queuing.

11.1 LEFT-TURN TREATMENTS

This section discusses the key safety, operational, and design characteristics associated with left-turn treatments that range in scope from a single left-turn lane to multiple left-turn lanes.

Left-turning vehicles encounter conflicts from several sources: pedestrians; bicyclists; opposing through traffic; through traffic in the same direction; and crossing traffic. These conflicts can cause angle-, sideswipe, left-turn, and rear-end crashes.

The demand for left-turn movements also affects the amount of green time that is allocated to other traffic movements. Operational treatments may be justified to minimize the amount of green time that is allocated to left-turn movements. This will allow the practitioner to reallocate time to other critical movements.

11.1.1 Add Single Left-Turn Lane

Adding a single left-turn lane at an approach that currently has shared through and left-turn movements is one of the most common approaches to improve the safety and reduce delay. An example of a typical left-turn lane is shown in Exhibit 11-1. Installing a left-turn lane on one approach does not necessarily mean that a left-turn lane for the opposing left is necessary. If one left-turn lane is installed, the practitioner should ensure that the traveling path of through traffic transitions through the signal into the correct lane.

Left-turning vehicles stopped in traffic while waiting for a gap in opposing traffic are prone to rear-end crashes. Separate left-turn lanes provide a refuge while waiting for a gap. Reviewing the crash history collision diagrams or the results of a traffic conflict study can provide the basis for adding a left-turn lane or changing left-turn phasing. Practitioners should look for a history of rear ends or left-turn crashes on any given approach.

A left-turn lane provides left-turning vehicles space to safely decelerate away from through traffic. Reducing this conflict directly impacts rear end collisions. If practicable, the left-turn lane should be long enough to accommodate most of the deceleration needed to stop at the intersection.

Left-turn lanes can help improve signals' efficiency. Separating through movements from left-turning vehicles can decrease the headway between vehicles and improve the flow rate through the signal for both movements. Different phasing options can be utilized to accommodate fluctuating traffic flow occurring throughout the day. For example, a lagging left turn needed for the morning commuters reverting back to simultaneous lefts for the rest of the day. The practitioner should always consider impacts to non-motorized travel. The typical impact is the additional pavement that pedestrians must cross and the walk time that must be added to signal's timing plan.

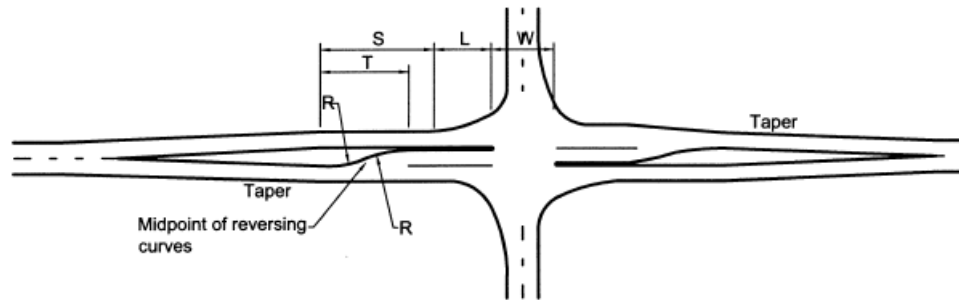

L = Storage length

R = Radius of reversing curve

S = Stopping sight distance for a speed of $(0.7)(\text{operating speed of highway})$

T = Tangent distance required to accommodate reversing curve

W = Minimum distance of 12 m (40 ft)

Exhibit 11-1. Diagram of a single left-turn lane.⁽¹⁸¹⁾

Applicability

Review local agencies' adopted guidelines and practices should be reviewed to determine whether left-turn lane warrants are in place for a particular roadway. Key elements to consider when determining whether a left-turn lane is warranted include:

- **Significant intersections.** A left-turn lane should be considered at the intersections of higher class facilities (i.e., arterials and principal arterials) and other public roads equal to a collector or higher classification to accommodate both higher approach speeds and expected growth in traffic volumes.
- **Prevailing approach speeds.** An increase in speed differentials between through and slower-speed left-turning vehicles may lead to an increase in rear-end collisions.
- **Capacity of an intersection.** The addition of a left-turn lane can increase the number of vehicles the intersection can serve.
- **Proportion of approach vehicles turning left.** Higher volumes of left-turn traffic result in increased conflicts and delay to through vehicles.
- **Volumes of opposing through vehicles.** High volumes of opposing vehicles reduce the number of gaps available for a left-turn movement (assuming permissive phasing), thus increasing conflicts and delay with approaching through movements.
- **Design conditions.** A left-turn lane may be needed to improve sight distance.
- **Crash history associated with turning vehicles.** A left-turn lane should be considered if there is a disproportionate amount of collisions involving left-turning vehicles on the approach.

In the absence of site-specific data, the *HCM 2010* indicates the probable need for a left-turn lane if the left-turn volume is greater than 100 vehicles in a peak hour, and the probable need for dual left-turn lanes if the volume exceeds 300 vehicles per hour.⁽²⁾ The HCM also indicates a left-turn lane should be provided if a left-turn phase is warranted.

Exhibit 11-2 highlights several rule-of-thumb intersection capacities for various scenarios where exclusive left-turn treatments may be required on one or both approaches to an intersection. In general, exclusive left-turn lanes are needed when a left-turn volume is greater

than 20 percent of total approach volume or when a left-turn volume is greater than 100 vehicles per hour in peak periods.⁽⁴⁸⁾

Case I: No Exclusive Left-Turn Lanes

Assumed critical signal phases* 2

Left-turn volumes Critical major approach:** ≤ 125 veh/hr
Critical minor approach: ≤ 100 veh/hr

Planning-level capacity (veh/hr), sum of critical approach volumes***		Number of basic lanes,**** major approach		
		2	3	4
Number of basic lanes, minor approach	1	1,700	2,300	—
	2	2,400	3,000	—
	3	—	—	—

Case II: Exclusive Left-Turn Lane on Major Approaches Only

Assumed critical signal phases 3

Left-turn volumes Critical major approach: 150-350 veh/hr
Critical minor approach: ≤ 125 veh/hr

Planning-level capacity (veh/hr), sum of critical approach volumes		Number of basic lanes, major approach		
		2	3	4
Number of basic lanes, minor approach	1	1,600	2,100	2,300
	2	2,100	2,600	2,800
	3	2,700	3,000	3,200

Case III: Exclusive Left-Turn Lane on Both Major and Minor Approaches

Assumed critical signal phases 4

Left-turn volumes Critical major approach: 150-350 veh/hr
Critical minor approach: 150-250 veh/hr

Planning-level capacity (veh/hr), sum of critical approach volumes		Number of basic lanes, major approach		
		2	3	4
Number of basic lanes, minor approach	1	1,500	1,800	2,000
	2	1,900	2,100	2,400
	3	2,200	2,300	2,800

Notes: *Critical signal phases are non-concurrent phases
 **A critical approach is the higher of two opposing approaches (assumes same number of lanes)
 ***Use fraction of capacity for design purposes (e.g., 85 or 90 percent)
 ****Basic lanes are through lanes, exclusive of turning lanes
 Adapted from NCHRP 279, figure 4-11⁽⁴⁸⁾

Exhibit 11-2. Rule-of-thumb intersection capacities assuming various exclusive left-turn treatments.

Key Design Features

Key design elements of an exclusive left-turn lane include: entering taper, storage length, lane width, and offset. Design criteria for left-turn lanes are presented in the AASHTO *A Policy on Geometric Design for Highways and Streets* as well as in the policies of individual highway agencies.⁽³⁾

Entering taper. Entering tapers should be designed to: (1) allow vehicles to depart the through travel lane with minimum braking; and (2) provide adequate length to decelerate and join the back of queue. In practice, some deceleration (10 mph) is considered acceptable in the

through lane prior to entering the turn lane. An appropriate combination of deceleration and taper length will vary according to the situation at individual intersections. A relatively short taper and a longer deceleration length may be applicable at busier intersections where speeds are slower during peak hours. This allows more storage space during peak hours and reduces the potential for spillover into the adjacent through lane. However, off-peak conditions should be considered when vehicle speeds may be higher, thus requiring a longer deceleration length.

AASHTO indicates a taper rate of 8:1 for 30 mph to 15:1 for 50 mph or greater is common for high-speed roadways. Using a taper that is too short may require a vehicle to stop suddenly, thus increasing the potential for rear-end collisions. Using too long of a taper may result in drivers inadvertently drifting into the left-turn lane, especially if located within a horizontal curve. AASHTO indicates that municipalities and urban counties are increasingly adopting the use of taper lengths such as 100 ft for a single turn lane and 150 ft for a dual turn lane.⁽³⁾

Storage length. The length of the left-turn bay should be sufficient to store the number of vehicles likely to accumulate during a critical period so the lane may operate independent of the through lanes. The storage length should be sufficient to prevent vehicles spilling back from the auxiliary lane into the adjacent through lane. Storage length is a function of the cycle length, signal phasing, rate of arrivals and departures, and vehicle mix. As a rule-of-thumb, the left-turn lane should be designed to accommodate one and one-half to two times the average number of vehicle queues per cycle, although methods vary by jurisdiction. The HCM can also be used to estimate queues, as noted in Chapter 7.⁽²⁾ Traffic models used to develop signal timing can provide an accurate estimate on queue length.

Lane width. Lane width requirements for left-turn lanes are largely based on operational considerations. Generally, lane widths of 12 ft are desirable to maximize traffic flow; however, right-of-way or non-motorized needs may dictate the use of a narrower lane width. For situations where it is not possible to achieve the standard width for a left-turn lane, providing a less-than-ideal lane is likely an improvement over providing no left-turn lane. Lane widths less than 9 ft are not recommended for new design. However, in some very constrained retrofit situations on lower speed roadways, lane widths as low as 8 ft for some left-turning movements may be a better choice than not providing any left-turn lane or having too few left-turn lanes. Achieving more lanes through restriping from 12-ft lanes to narrower lanes should be considered where appropriate.^{(57),(182)} Exhibit 11-3 shows an example from Montgomery County, Maryland, where a narrow left-turn lane has been used effectively.



Exhibit 11-3. Narrow left-turn lanes may be used effectively in retrofit situations.

Offset. A left-turning driver's view of opposing through traffic may be blocked by left-turning vehicles on the opposite approach. When left-turning traffic has a permissive signal phase, this can lead to collisions between vehicles turning left and through vehicles on the opposing

approach. In a situation with a negative offset or no offset, left-turning motorists can be blocked by opposing left turners (see Exhibit 11-4(a)). This should be avoided when possible.

The practitioner should consider left-turn lanes with a positive offset that allow drivers to see oncoming traffic without obstruction (see Exhibit 11-4(c)).

This practice helps improve safety and operations of the left-turn movement by improving driver acceptance of gaps in opposing through traffic and eliminating the potential for vehicle path overlap. This is especially true for older drivers who have difficulty judging gaps in front of oncoming vehicles. AASHTO policy recommends that medians wider than 18 ft should have positive offset left-turn lanes. However, providing any amount of offset that moves obstructing vehicles out of the way should be pursued. One method for laterally shifting left-turning vehicles is to narrow the turn-lane width using pavement markings.

Positive offsetting has other benefits. Positive offsetting of left-turn lanes ensures that the turning radii for opposing left-turning vehicles do not overlap each other. This allows these movements to be concurrent phases. Also, positive offsetting of the left-turn lanes can be useful for staged improvements. For example, dual lefts can be built on the major street approach, but cannot be utilized until the minor streets are widened. The outside turn lane is striped out to provide positive offset.

Offset left-turn lanes should remain parallel to the through travel route if practical. Exhibit 11-4 illustrates a positive offset at an intersection.⁽¹⁾

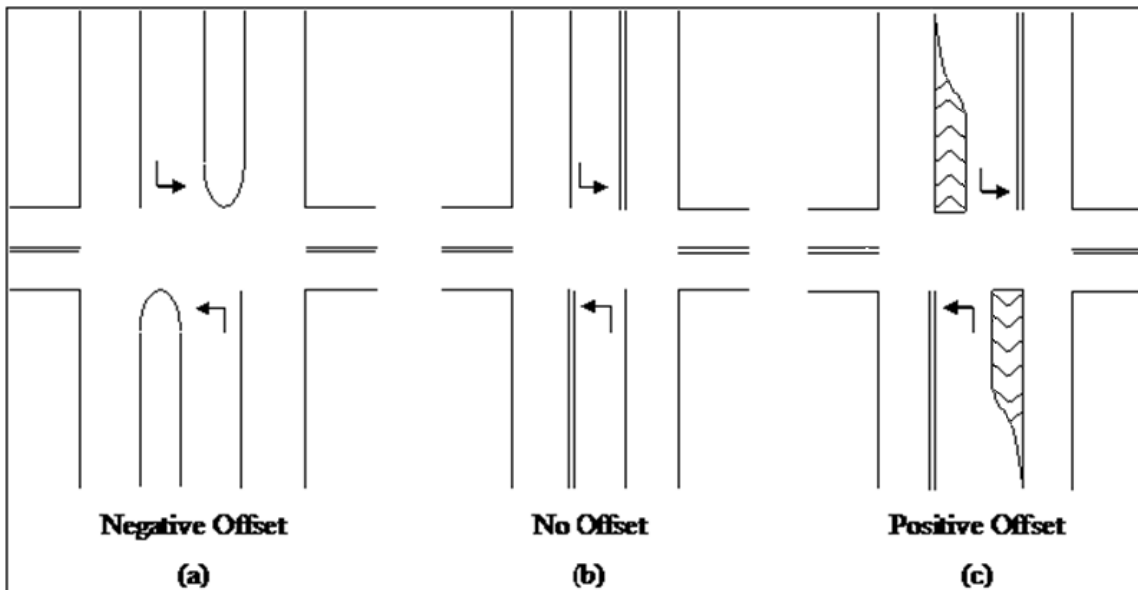

Exhibit 11-4. Illustration of negative, no, and positive offset left-turn lanes. Positive offset is preferred.⁽¹⁸³⁾



Exhibit 11-5. Example of positive offset left-turn lane.

Dropped Lane. In constrained areas, through lanes are sometimes converted to left-turn lanes. This type of lane is sometimes referred to as a “dropped” lane. The traffic control used to alert or raise awareness by the driver in this situation is critical especially at locations with higher speeds or congested areas. For this reason, the MUTCD requires the use of a wide dotted white lane line to distinguish the drop lane from the adjacent through lane (refer to MUTCD Section 3B.04).

Channelization

Physical channelization of left turns emphasizes separation of left-turning vehicles from the through traffic stream. It guides drivers through an intersection approach, increasing capacity and driver comfort.

A left-turn channelization design should incorporate consideration of the design vehicle, roadway cross section, traffic volumes, vehicle speeds, type and location of traffic control, pedestrians, and bus stops. In addition to these design criteria, consideration should be given to the travel path; drivers should not have to sharply change direction in order to follow the channelization. Channelizing devices should not cause drivers to make turns with angles that vary greatly from 90 degrees. If median treatments are used to channelize the left turn, pedestrian needs identified in Chapter 8 should be considered. Additional guidance is provided in the AASHTO policy.⁽³⁾

Channelization can be provided using curbed concrete, painted islands, or delineators. The appropriateness of raised or flush medians depends on conditions at a given intersection. Painted channelization provides guidance to drivers without presenting an obstruction in the roadway, and would be more appropriate where vehicles may be proceeding through the intersection at high speeds or where the design vehicle can be better accommodated. However, paint is more difficult to see at night, especially at intersections that are not lighted.

Raised curbed islands should provide guidance in the intersection area but should not present a significant obstruction to vehicles. Safety advantages of left-turn lanes with raised channelization include:

- Turning paths are clearly defined within an expansive median opening.
- Improved visibility for left-turning drivers.
- Simultaneous opposing left-turn lanes are offset from one another.
- Sideswipe collisions due to motorists' changing from left-turn to through lanes or vice versa are prevented.
- Median refuge for pedestrians providing a two stage crossing.
- Median islands can be used to control speed across crosswalks.

Raised pavement markings and "flex-post" delineators should be considered when use of raised channelization is not possible.

Operational Features

The type of signal phasing used for a left-turn movement directly affects the safety and operational performance of the turn. The practitioner should always strive to utilize the smallest number of phases. To accomplish this, less-restrictive phasing schemes are preferable where appropriate because these phases result in lower delay to all users of the intersection. However, the responsible agency for the signal's performance should review the operation and safety of the intersection on an annual basis to ensure the intersection is operating within expectations.

Exhibit 11-6 presents suggested guidelines for determining whether left-turn phasing is appropriate, and Exhibit 11-7 presents suggested guidelines for determining the type of left-turn phasing. Current signal equipment allows practitioners the flexibility to alter timing and phasing throughout the day as conditions warrant. Exhibit 11-8 presents the minimum recommended sight distance for permissive left turns. Note that many agencies have adopted similar guidelines with localized variations to reflect State policy. Examples of deviations include the following:

- Some States have a policy to always use protected-only left-turn phasing where the left-turn movement crosses three lanes, while other States allow the use of permissive phasing or protected-permissive phasing in those situations.
- Some States use values in the criteria that are more conservative than provided here, such as lower crash frequency thresholds for protected-only left-turn phasing.
- Some municipalities (Tucson, AZ; Denver, CO) allow the use of protected-permissive phasing at double left turns, while most States use protected-only phasing for those locations.

Left-turn phasing (protected-permissive, permissive-protected, or protected-only) should be considered if any one of the following criteria is satisfied:

1. A minimum of 2 left-turning vehicles per cycle and the product of opposing and left-turn hourly volumes exceeds the appropriate following value:
 - a. Random arrivals (no other traffic signals within 0.5 mi):
One opposing lane: 45,000 Two opposing lanes: 90,000
 - b. Platoon arrivals (other traffic signals within 0.5 mi):
One opposing lane: 50,000 Two opposing lanes: 100,000
 2. The left-turning movement crosses 3 or more lanes of opposing through traffic.
 3. The posted speed of opposing traffic exceeds 45 mph.
 4. Recent crash history for a 12-month period indicates 5 or more left-turn collisions that could be prevented by the installation of left-turn signals.
 5. Sight distances to oncoming traffic are less than the minimum distances in Exhibit 11-7.
 6. The intersection has unusual geometric configurations, such as five legs, when an analysis indicates that left-turn or other special traffic signal phases would be appropriate to provide positive direction to the motorist.
 7. An opposing left-turn approach has a left-turn signal or meets one or more of the criteria in this table.
 8. An engineering study indicates a need for left-turn signals. Items that may be considered include, but are not necessarily limited to, pedestrian volumes, traffic signal progression, freeway interchange design, maneuverability of particular classes of vehicles, and operational requirements unique to preemption systems.
-

Exhibit 11-6. Guidelines for use of left-turn phasing.^{(184),(185)}

The type of phasing to use can be based on the following criteria:

1. Insignificant number of adequate gaps in opposing traffic to complete a left turn.
2. Permissive left-turn phasing may be considered at sites that do not satisfy any of the left-turn phasing criteria listed in Exhibit 11-6.
3. Protected-permissive left-turn phasing may be considered at sites that satisfy one or more of the left-turn phasing criteria listed in Exhibit 11-6 but do not satisfy the phasing criteria for protected-only phasing (see criterion 4 below). Protected-permissive phasing is not appropriate when left-turn phasing is installed as a result of an accident problem.
4. Permissive-protected left-turn phasing may be considered at sites that satisfy the criteria for protected-permissive phasing and one of the following criteria:
 - a. The movement has no opposing left turn (such as at a T-intersection) or the movement is prohibited (such as at a freeway ramp terminal).
 - b. A protected-permissive signal display is used that provides the left-turning vehicle with an indication of when the driver must yield to opposing traffic, a flashing yellow arrow, or other such devices.
5. Protected-only left-turn phasing should be considered if any one of the following criteria is satisfied:
 - a. A minimum of 2 left-turning vehicles per cycle and the product of opposing and left-turn hourly volumes exceed 130,000-150,000 for one opposing lane or 300,000 for two opposing lanes.
 - b. The posted speed of opposing traffic exceeds 45 mph.
 - c. Left-turning crashes per approach (including crashes involving pedestrians) equal 4 or more per year, or 6 or more in 2 years, or 8 or more in 3 years.
 - d. The left-turning movement crosses three or more lanes of opposing through traffic.
 - e. Multiple left-turn lanes are provided.
 - f. Sight distances to oncoming traffic are less than the minimum distances in Exhibit 11-8.
 - g. The signal is located in a traffic signal system that may require the use of lead-lag left-turn phasing. This criterion does not apply if:
 - i. An analysis indicates lead-lag phasing is not needed.
 - ii. An analysis indicates that protected-permissive phasing reduces total delay more than lead-lag phasing.
 - iii. A protected-permissive signal display is used that allows a permissive left turn to operate safely opposite a lagging protected left-turn phase (see Chapter 2 for discussion of left-turn trap).
 - h. An engineering study indicates a need for left-turn signals. Items that may be considered include, but are not necessarily limited to, pedestrian volumes, traffic signal progression, freeway interchange design, maneuverability of particular classes of vehicles, number of older drivers, and operational requirements unique to preemption systems.

Exhibit 11-7. Guidelines for selection of type of left-turn phasing.^(184,185)

Design Speed (mph)	Design Intersection Sight Distance for Passenger Cars* (ft)
20	165
25	205
30	245
35	285
40	325
45	365
50	405
55	445
60	490
65	530

* For a passenger car making a left turn from an undivided highway. For other conditions and design vehicles, the time gap should be adjusted and the sight distance recalculated.

Source: Adapted from (3), exhibit 9-67

Exhibit 11-8. Minimum recommended sight distance for allowing permissive left turns.

Safety Performance

The HSM contains information that allows practitioners to quantify the safety impacts of left-turning phasing and/or left-turn lanes. Exhibits 11-9 and 11-10 identify CMFs used to calculate the number of crashes per year. The exhibits show favorable impacts towards safety through the addition of a lane and exclusive left-turn movements.

The presence of a left-turn lane could create situations where vehicles are more likely to off-track. Large trucks and buses are more likely to off-track than passenger cars particularly if short tapers are used to shift through traffic. Off-tracking increases the likelihood of sideswipe and head on crashes between left-turning and adjacent through vehicles and between opposing left-turning vehicles. These impacts to large vehicles can be reduced with proper lengths of tapers and appropriate pavement markings.

In providing left-turn lanes, vehicles in opposing left-turn lanes may block their respective drivers' view of approaching vehicles in the through lanes. This potential problem can be resolved by offsetting the left-turn lanes.

Exhibit 11-9 shows safety benefits of left-turn geometric improvements. All collision modification factors suggest safety improvements associated with providing a left-turn lane at a signalized intersection. Collision types that would particularly benefit from a left-turn lane are rear-end and left-turn collisions. Provision of a left-turn lane in conjunction with protected left-turn phasing would appear to provide the most benefit.

Crash Modification Factor (CMF ₁₁) for Installation of Left-Turn Lanes on Intersection Approaches					
Intersection Type	Intersection traffic control	Number of approaches with left-turn lanes ^a			
		One approach	Two approaches	Three approaches	Four approaches
3 Approaches	Traffic signal	0.93	0.86	0.80	0.80
4 Approaches	Traffic signal	0.90	0.81	0.73	0.66

Exhibit 11-9. Safety benefits associated with left-turn lane improvements for four approach, urban and suburban intersection.

Source: Highway Safety Manual.⁽¹¹⁾

Potential Crash Effects of Modifying Left-Turn Phase at Urban Signalized Intersections (8,15,22)

Treatment	Setting (Intersection Type)	Traffic Volume AADT (veh/day)	Crash Type (Severity)	CMF	Std. Error
Change to protected phasing (8,15)	Urban (Four- and three-leg signalized)	Unspecified	Left-turn crashes on treated approach (All severities)	0.01*	0.01
			All types (All severities)	0.94**	0.1
Change from permissive to protected/permissive or permissive/protected phasing (15,22)	Urban (Four-leg signalized)	Major road 3,000 to 77,000 and minor road 1 to 45,500	Left-turn (Injury)	0.84	0.02
Change from permissive to protected/permissive or permissive/protected phasing (15)	Urban (Four-leg signalized)	Unspecified	All types (All severities)	0.99	N/A*

Base Condition: For changing to protected phasing, the base condition is permissive, permissive/protected, or protected/permissive phasing. For changing to permissive/protected or protected/permissive phasing, the base condition is permitted phasing.

NOTE: Bold text is used for the most reliable CMFs. These CMFs have a standard error of 0.1 or less.

* Observed variability suggests that this treatment could result in an increase, decrease, or no change in crashes. See Part D—Introduction and Applications Guidance.

** Standard error of CMF is unknown.

- Combined CMF, see Part D—Introduction and Applications Guidance.

Exhibit 11-10. Crash effects of modifying left-turn phases
Source: Highway Safety Manual⁽¹⁾

Operational Performance

The addition of a left-turn lane increases capacity for the approach by removing left-turn movements from the through traffic stream. The addition of a left-turn lane may allow for the use of a shorter cycle length or allocation of green time to other critical movements.

The additional pavement width associated with the left-turn lane increases the crossing width for pedestrians and may increase the minimum time required for pedestrians to cross. In addition, the wider roadway section likely will increase the amount of clearance time required for the minor street approach. Restriping the roadway with narrower lanes can minimize this problem.

If a left-turn lane is excessively long, through drivers may enter the lane by mistake without realizing it is a left-turn lane. Effective signing and marking of the upstream end of the left-turn lane should remedy this problem.

Practitioners considering adding protected left turn phasing should evaluate the impacts to other movements at the intersection. Other movements may experience increases in queue lengths, and stopped approach delay for all users. Impacts to coordination also should be evaluated prior to implementation of additional left turn phasing.

Multimodal Impacts

For cases where widening is required to add a left-turn lane, the pedestrians will need to walk further to cross the street increasing the conflict between vehicles and pedestrians. Consider pedestrian refuges (along with push buttons) for wide roadway sections (approximately 75 ft).⁽¹⁸⁶⁾

Practitioners should consider the volumes of truck and bus traffic using the lane in the design of a left-turn lane.

Physical Impacts

Adding a left-turn lane will increase the footprint of the intersection if no median is currently present, except when the approach is restriped with narrower lanes. The approach to the intersection will be wider to accommodate the auxiliary lane.

Designers should also use caution when considering restriping a shoulder to provide or lengthen a left-turn lane. Part of the safety benefits of installing the turn lane may be lost due to a loss of shoulder, less proximity to roadside objects, and a reduction in intersection sight distance. In addition, the shoulder may not have been designed and constructed to a depth that will support considerable traffic volumes and may require costly reconstruction.

Socioeconomic Impacts

The potential reduction in travel time and in vehicle emissions is a benefit of left-turn lanes. A certain degree of comfort is provided to drivers when they are able to wait to turn outside of the through traffic stream, since they are not delaying other vehicles and can wait for a comfortable gap.

The cost of construction and the accompanying signing, striping, and additional signal equipment are one of the main economic disadvantages to installing a left-turn lane. Also, access to properties adjacent to the intersection approach may need to be restricted when a left-turn lane is installed.

Enforcement, Education, and Maintenance

Given that left-turn lanes are common at signalized intersections, no education should be needed to prepare drivers for installation of a lane at an intersection.

Maintenance issues for left-turn lanes and phasing will be the same as for other areas of the intersection. Pavement markings, signs, and indications should be kept visible and legible. Pavement skid resistance should be maintained. Detection systems should be checked for any call failures. In addition, ongoing reviews through intersection counts, observations, and periodic checks of performance goals related to crashes, delay, and network compatibility are needed.

Summary

Exhibit 11-11 provides a summary of the issues associated with left-turn lanes.

Characteristic	Potential Benefits	Potential Concerns
Safety	Separation of left-turn vehicles from through movements.	Increased pedestrian exposure.
Operations	Additional capacity. Potential for shorter cycle lengths and/or allocation of green to other movements.	Spillback; inadequacy of design.
Multimodal	Left-turn lane may result in shorter pedestrian delays due to shorter cycle length.	Depending on design, may result in longer crossing time and exposure for pedestrians.
Physical	None identified.	Increased intersection size. *
Socioeconomic	Travel time reduced. Vehicle emissions reduced.	Right-of-way and construction costs. *
Enforcement, Education, and Maintenance	None identified.	None identified. Adding signals without funding adjustment reduces ability to properly maintain all intersections.

* Applies to situations where the left-turn lane is added by physical widening rather than restriping.

Exhibit 11-11. Summary of issues for left-turn lanes.

11.1.2 Multiple Left-Turn Lanes

Multiple left-turn lanes are widely used at signalized intersections where traffic volumes have increased to the point that signal timing cannot alleviate excessive queues and delay with the current number of lanes.

Multiple left-turn lanes allow for the allocation of green time to other critical movements or utilize a shorter cycle length. Using multiple left-turn lanes helps reduce the queue waiting to turn left; the practitioner will need to estimate how many vehicles may be in each lane. Rarely will there be an even distribution among the turn lanes, which can dramatically impact the signal timing.

Applicability

Double and triple left-turn lanes are appropriate at intersections with high left-turn volumes that cannot be adequately served in a single lane. As a rule-of-thumb, consider dual left-turn lanes when left-turn volumes exceed 300 vehicles per hour (assuming moderate levels of opposing through traffic and adjacent street traffic). A left-turn demand exceeding 600 vehicles per hour indicates a triple left-turn may be appropriate. Lane distribution for triple lefts is critical to operational success.⁽¹⁸⁷⁾

While effective in improving intersection capacity, double or triple lefts are not appropriate where:

- A high number of vehicle-pedestrian conflicts occur.
- Left-turning vehicles are not expected to evenly distribute themselves among the lanes.
- Channelization may be obscured.
- Sufficient right-of-way is not available to provide for the design vehicle.
- Other alternative intersections may be a more appropriate option.
- An insufficient number of departure lanes exist.

Design Features

The design of multiple left-turn lanes is similar to that of single turn lanes. In addition, the interaction between vehicles in adjacent lanes and also the width of the receiving lanes should be considered. The following are design considerations for triple left-turn lanes provided by Ackeret.⁽¹⁸⁸⁾ These same considerations apply for double left-turn lanes:

- Widths of receiving lanes.
- Width of intersection (to accommodate three vehicles abreast).
- Clearance between opposing left-turn movements during concurrent maneuvers.
- Pavement marking and signing visibility.
- Placement of stop lines for left-turning and through vehicles.
- Weaving movements downstream of turn.
- Potential for pedestrian conflict.

The previous section provided criteria for selecting the type of signal phasing to be used. In general, protected-only left-turn phasing is used for most double-lane and triple-lane left-turn movements, although some agencies have used protected-permissive phasing for double left turns.

Operational Features

Drivers may be confused when attempting to determine their proper turn path on an approach with multiple left-turn lanes. Providing positive guidance for the driver in the form of pavement markings can help eliminate driver confusion and eliminate vehicle conflict by channeling vehicles in their proper turn path.

Delineation of turn paths is especially useful to drivers making simultaneous opposing left turns, as well as in some cases where drivers turn right when a clear path is not readily apparent. This strategy is also appropriate when the roadway alignment may be confusing or unexpected.

Delineation of turn paths is expected to improve intersection safety, though the effectiveness has not been well evaluated. The additional guidance in the intersection will help separate vehicles making opposing left turns, as well as vehicles turning in adjacent turn lanes.

Additional operational features of dual and triple left-turn lanes are identified below.

- Prominent and well-placed signing, located over each lane if feasible, should be used with triple left-turn movements, especially in advance of the intersection. The signing will help maximize the benefits of triple lefts. Lane distribution for triple left-turn lanes should be estimated as close as possible. Practitioners should reevaluate marking and signing immediately after the triple lefts are constructed for any necessary adjustments.
- The excess green time for left-turn movements resulting from the additional lane should be allocated to other critical movements or removed from the entire cycle to reduce the cycle length.
- Triple left turns should not include a permissive phase; they should be protected only at all times of day.

Safety Performance

A literature review shows that dual left-turn lanes with protected-only phasing generally operate with minimal negative safety impacts. Common crash types in multiple turn lanes are sideswipes between vehicles in the turn lanes. Turn path delineation guides drivers through their lane and can help reduce sideswipes at left-turn maneuvers.

A study of double and triple left-turn lanes in Las Vegas, NV, showed that about 8 percent of intersection-related sideswipes occur at double lefts, and 50 percent at triple lefts.⁽¹⁸⁹⁾ These

sideswipes are 1.4 and 9.2 percent of all crashes at the intersections with double and triple lefts, respectively. Turn path geometry and elimination of downstream bottlenecks are important considerations for reducing sideswipes.

One study indicates that triple left-turn lanes have been shown to operate well, and drivers do not have trouble understanding the triple left turns.⁽¹⁹⁰⁾ In addition, construction of triple left-turn lanes has not resulted in unexpected or unacceptable crash experiences. Another study showed that 10 percent of the crashes at intersections with triple lefts occurred in the approach for the triple left. These are angle crashes that occur when left-turning vehicles collide with through traffic on the cross street. These crashes are attributed to short change and clearance intervals and limited sight distance, not operation of the triple left.

Exhibit 11-12 presents selected findings of the safety benefits of multiple left-turn lanes.

Treatment	Finding
Double left-turn lane. ⁽¹⁶³⁾	29 percent estimated reduction in all fatal/injury collisions. 26 percent estimated reduction in all PDO collisions. 29 percent estimated reduction in fatal/injury rear-end collisions. 47 percent estimated reduction in fatal/injury left-turn collisions. 20 percent estimated reduction in angle fatal/injury collisions.
Triple left –turn lanes.	Texas study found triple lefts did not raise any major safety issues.

Exhibit 11-12. Safety benefits associated with double left-turn lanes: selected findings.

Operational Performance

Multiple left-turn lanes can improve intersection operations by reducing the time allocated to the signal phase for the left-turn movement. Triple left-turn lanes have been constructed to meet the left-turn capacity demand without having to construct an interchange. This configuration can accommodate left-turn volumes of more than 600 vehicles per hour. Vehicle delays, intersection queues, and green time for the left-turn movement are all reduced, improving operation of the entire intersection.

To achieve this level of performance, these turning movements should still be serviced through normal phasing sequences. If these turns require split-phasing and/or independent phasing, the advantages mentioned in the previous paragraph will not be long term. Evaluation of the signal timing necessary for the triple left-using traffic software and simulation is key to a successful implementation of multiple left-turn lanes. The practitioner may need to compare triple lefts with other alternative intersection designs.

While dual left-turn lanes are largely operated with protected-only phasing, some agencies use protected-permissive signal phasing. This signal phasing improves capacity for the left-turn movements, particularly during nonpeak times when opposing traffic volumes are lower. Many agencies have safety concerns regarding permissive left-turns in a double turn lane. In fact, many agencies only allow dual left-turn lanes to be run as protected-only phasing. However, some agencies overcome this concern by offsetting the dual left-turn lanes.

Multimodal Impacts

Adding turn lanes increases the crossing distance for pedestrians, as well as their exposure to potential conflicts if roadway widening is required. One method to mitigate this exposure is the use of median refuge islands for pedestrians. The islands reduce the walking distance and provide safe areas for pedestrians and bicyclists to wait. These refuge islands also allow for a two stage crossing.

Physical Impacts

Installation of a second or third turn lane will increase the footprint of the intersection, except when additional lanes can be accommodated through restriping. As with single left-turn lanes, practitioners should consider right-of-way costs and access to adjacent properties.

Socioeconomic Impacts

A shorter green time for left-turning vehicles, made possible by multiple turn lanes, can provide more green time to other movements. As this reduces delay, it will also reduce vehicle emissions.

Enforcement, Education, and Maintenance

Little or no education should be needed for multiple left-turn lanes that operate with protected-only or split phasing other than lane assignment signing and markings. Some public information may be needed to educate drivers regarding a permissive movement at a double left-turn lane.

Summary

Exhibit 11-13 summarizes the issues associated with multiple left-turn lanes.

Characteristic	Potential Benefits	Potential Concerns
Safety	Potential reduction in collisions.	Permissive phasing can increase the opportunity for left turn crashes.
Operations	Potential improvement in capacity.	Unbalanced lane utilization.
Multimodal	None identified	Longer crossing distance and more exposure.
Physical	None identified.	Multiple turn lanes may increase the footprint of the intersection.
Socioeconomic	Potential reduction in vehicle emissions due to lower delay.	None identified.
Enforcement, Education, and Maintenance	None identified.	Maintaining more equipment, pavement, marking, signing. Enforcement of triple lefts may be an issue.

Exhibit 11-13. Summary of issues for multiple left-turn lanes.

11.2 RIGHT-TURN TREATMENTS

The purpose of this section is to highlight what strategies are available to practitioners for right-turning movements. Significant volumes of right-turning vehicles can adversely impact the operations and safety of a signalized intersection. Typical improvements used to offset these adverse impacts range from channelizing islands to right-turn lanes. This section will move from lower to higher impact improvements related to additional property.

Practitioners should consider phasing overlaps for right-turning movements. The ability to share green time with compatible movements at the intersection can reduce the need for some of the following treatments.⁽¹⁸⁷⁾

11.2.1 Channelizing Islands

Channelizing islands that physically separate through and right-turning movements are constructed to improve the operations and/or safety of an intersection. These islands can be constructed as standalone improvements or built in combination with a right-turn lane.

Applicability

Channelization of the right turn with a raised or painted island can provide larger turning radii to accommodate large design vehicles. A larger turning radius also allows higher turning speeds. These higher speeds help increase the efficiency of the right-turning vehicles. The island allows some queuing of through traffic and provides access for right-turning vehicles to travel through the intersection.

Agencies increasingly install raised channelized islands to provide an area for pedestrian refuge. Crosswalks with long crossing distances can be reduced somewhat by providing these islands.

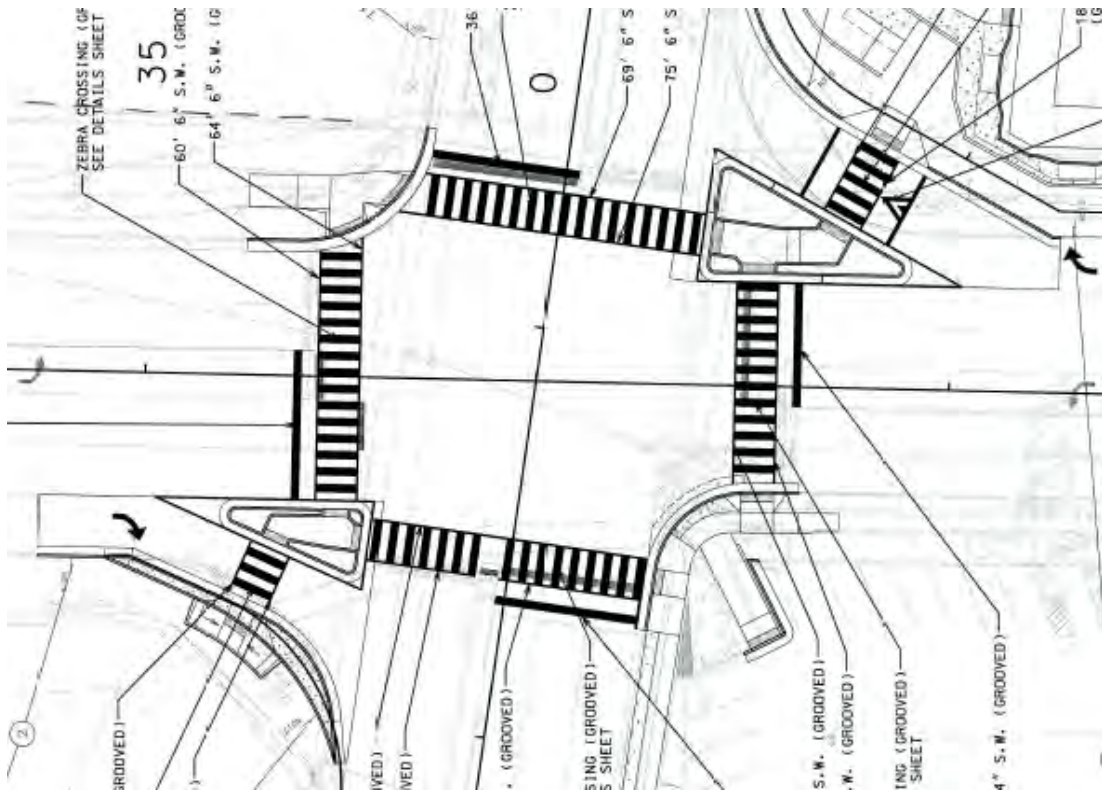

(11-14a) (a. City of Columbia, MO)
Exhibit 11-14. Channelized islands.

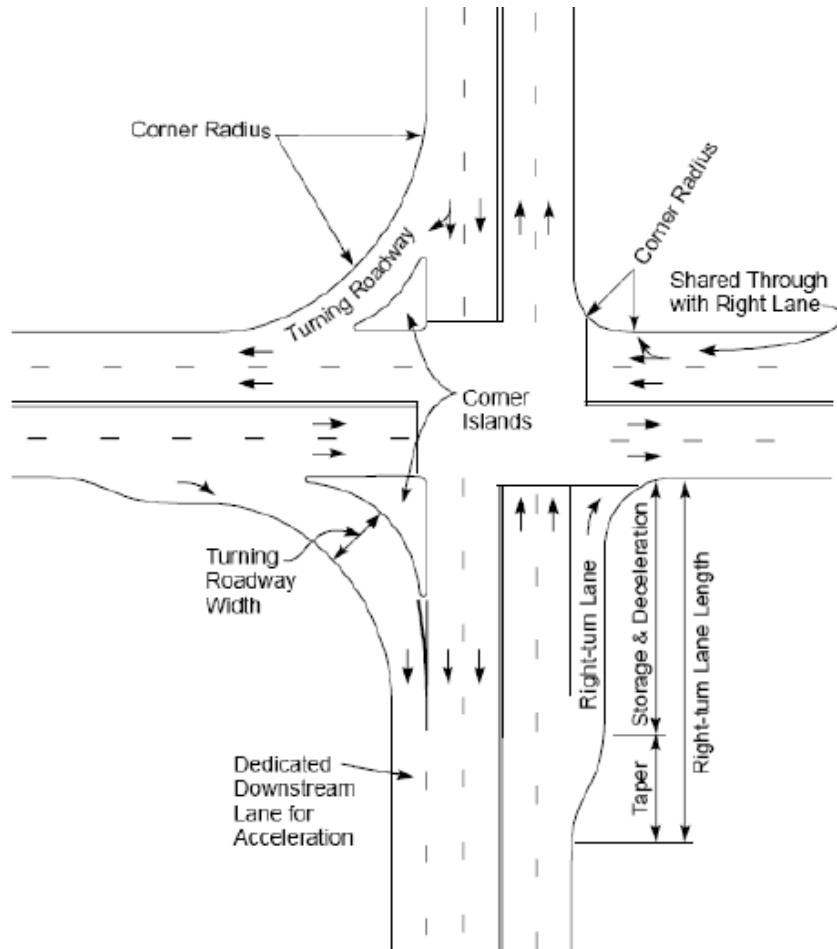

Figure 2-20. Right-Turn Lane and Right Turning Roadway Examples.

Source: Fitzpatrick and Schneider (2004)

(11-14b)⁽²⁰⁰⁾

Exhibit 11-14. Channelized islands (cont'd).

Key Design Features

Channelizing islands can be raised or flush with the pavement. A Georgia study evaluated the effects of right-turn channelization in the form of painted islands, small raised islands, and large raised islands.⁽¹⁹¹⁾ Results show that traffic islands appear to reduce the number of right-turn angle crashes, and the addition of an exclusive turn lane appears to correspond to an increased number of sideswipe crashes given the introduction of a lane change.

Raised channelized islands using simple curves find high incidences of rear-end and pedestrian crashes. As driver's focus to their left anticipating on-coming traffic, they lose sight of the vehicle they were following who chooses to yield. To aid driver's line of sight while turning right, an "Australian" right is used. A large radius allows a right turn vehicle to maneuver by the island, but allows viewing all of the details in front of them.

Exhibit 11-15 illustrates a channelized right-turn lane.

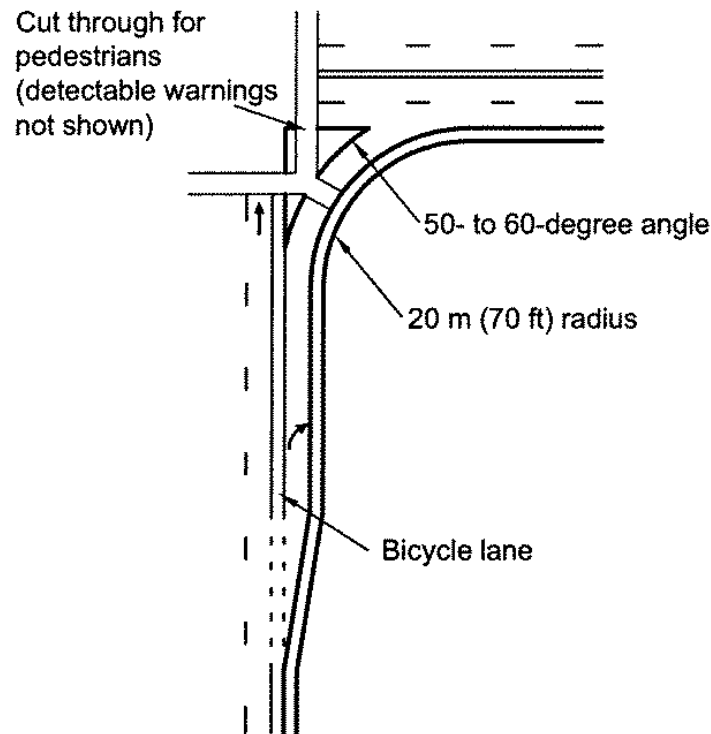

Exhibit 11-15. Example illustration of a channelized right-turn lane.

Channelized right-turn lanes apply for intersections with a high volume of right-turning vehicles that experience excessive delay due to the traffic signal. The larger the turn radius, the higher vehicle speeds can be. An important consideration is the desired speed of the turning vehicles as they enter the crossroad. The turn radius can be used to control speed, especially if the speed varies greatly from the road the vehicle is turning from. Additionally, larger turn radii and higher speeds can pose a pedestrian safety issue.

A channelized right-turn lane will have a larger footprint than an intersection with a conventional right-turn lane. Additional right-of-way may be needed to accommodate the larger corner radius. Constructing a departure auxiliary lane to allow for a downstream merge may also increase right-of-way costs.

Operational Features

The right turn may operate as a free flow movement if an acceleration lane is provided on the cross street, or the movement may be controlled by a YIELD sign where the turning roadway enters the cross street. Periodic enforcement may be needed to ensure drivers obey any traffic control devices used for the right-turn roadway (such as a YIELD sign).

Visibility of channelizing islands is very important. Islands can be difficult for drivers to see, especially at night and in inclement weather. This is particularly true for older drivers. Raised islands have been found to be more effective than flush painted islands at reducing nighttime collisions, because they are easier to see.

Older drivers, in particular, benefit from channelization as it provides a better indication of the proper use of travel lanes at intersections. However, older drivers often find making a right turn without the benefit of an acceleration lane on the crossing street to be particularly difficult.

Safety Performance

A reduction in rear-end collisions involving right-turning vehicles and following through vehicles could be expected after construction of a right-turn roadway. Turning vehicles will not need to decelerate as much as they would for a standard right-turn lane, and therefore the speed differentials between turning and through vehicles would not be as great.

The potential for rear-end and sideswipe crashes on the departure lanes may increase as the vehicles turning onto the crossroad merge with the vehicles already on the road.

Higher speeds and a possibly longer crossing distance and exposure could lead to an increase in crashes involving pedestrians, and the resulting crashes will likely have more serious consequences.

Safety benefits of right-turn channelization are shown in Exhibit 11-16.

Exhibit 11-16. Safety benefits associated with right-turn channelization: selected findings.⁽²⁰⁰⁾

Treatment	Finding
Channelization	25 percent decrease in all collisions 50 percent decrease in right-turn collisions

Operational Performance

Through vehicles will experience less delay if right-turning vehicles do not have to decelerate in a through lane. If the volume of right turns is significant enough that the right turn is the critical movement on an approach, provision of a right-turn roadway may increase capacity enough that more green time can be provided for other movements.

Multimodal Impacts

Curbed islands offer a pedestrian refuge. Crossing paths should be clearly delineated, and the island itself should be made as visible as possible to passing motorists.

Right-turn roadways can reduce the safety of pedestrian crossings if an area is not provided for pedestrian refuge. Right-turn roadways increase crossing distances and pedestrian exposure to traffic. Elderly and mobility-impaired pedestrians may have difficulty crossing intersections with large corner radii. Right-turn channelization also makes it more difficult for pedestrians to cross the intersection safely, adequately see oncoming traffic that will turn right, and know where to cross. Proper delineation of the turning roadway may help, particularly at night.

Larger turn radii result in higher vehicle speeds. In areas with significant pedestrian traffic, consideration should be given to minimizing the curb radii while still accommodating the turning path of the design vehicle. Minimizing the curb radii will reduce vehicular turning speeds, minimize pedestrian crossing distances, and reduce the potential severity of vehicle-pedestrian collisions.

Socioeconomic Impacts

Access to adjacent properties may need to be restricted to provide a merge area. Owners of adjacent property should be involved in early discussions regarding the plans.

Summary

Exhibit 11-17 summarizes the issues associated with channelized right-turn lanes.

Characteristics	Potential Benefits	Potential Liabilities
Safety	Separation of decelerating right-turn vehicles.	Potential for sideswipes and rear-end collisions on departure leg. Pedestrian crosswalk design compatibility.
Operations	Higher right-turn capacity. Shorter green time. Less delay for following through vehicles.	None identified. "Australian Right" may not accommodate large vehicles
Multimodal	Pedestrian refuge area.	Longer pedestrian crossing distance and exposure. Higher vehicle speeds.
Physical	Smaller impact than a lane along the right-of-way	Larger intersection footprint.
Socioeconomic	Support a mixed use, walkable community	Right-of-way costs. Access restrictions to property.
Enforcement, Education, and Maintenance	None identified.	Higher maintenance of islands, marking, signing

Exhibit 11-17. Summary of issues for channelized right-turn lanes.

11.2.2 Right-Turn Lanes

Turning vehicles' deceleration creates a speed differential between them and the through vehicles. This can lead to delay for the through vehicles, as well as rear-end crashes involving both movements.

In addition to providing safety benefits for approaching vehicles, right-turn lanes at signalized intersections can reduce vehicular delay and increase intersection capacity.

Exhibit 11-18 illustrates the operational impacts of a right-turn lane.

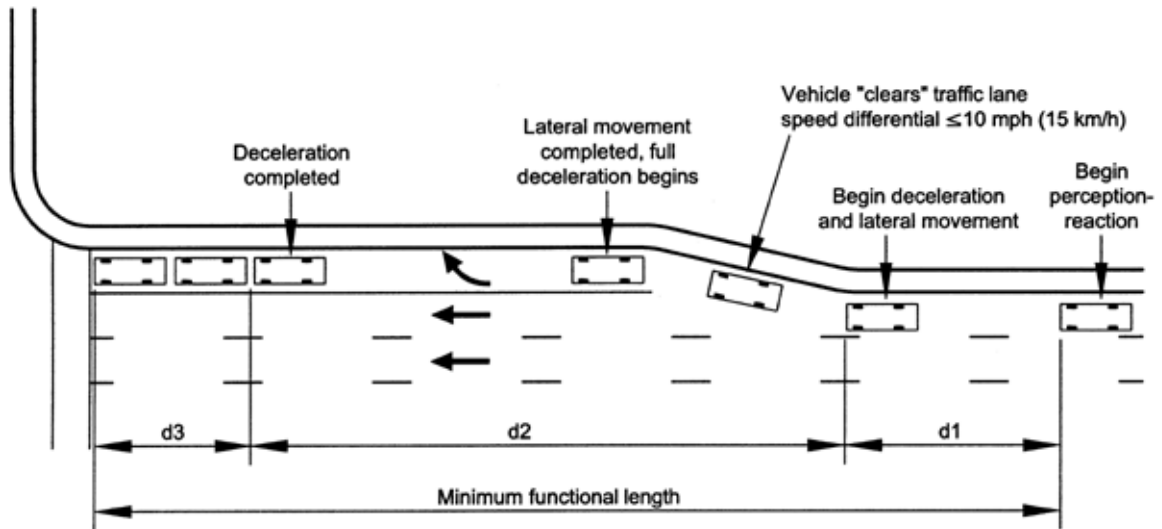

Exhibit 11-18. Diagram of a typical right-turn lane. (adapted from 192)

Right-Turn Lane Warrants

Similar to left-turn lane warrants, review the adopted guidelines and practices from local agencies when determining if a right-turn lane is warranted. Factors to consider include vehicle speeds, turning and through volumes, percentage of trucks, approach capacity, desire to provide right-turn-on-red operation, type of highway, arrangement/frequency of intersections, crash history involving right turns, pedestrian conflicts, and available right-of-way.

NCHRP 279 identifies warrants for right-turn lanes on four-lane, high-speed roadways, shown in Exhibit 11-19.⁽⁴⁸⁾ These warrants are based on the percentage of vehicles turning right (as a percentage of through vehicles) during the peak period.

State	Conditions Warranting Right-Turn Lane off Major (Through Highway)		
	Through Volume	Right-Turn Volume	Highway Conditions
Alaska	N/A	DHV = 25 vph	
Idaho	DHV = 200 vph	DHV = 5 vph	2 lanes
Michigan	N/A	ADT = 600 vpd	2 lanes
Minnesota	ADT = 1,500 vpd	All	Design speed > 70 km/h (45 mph)
Utah	DHV = 300 vph	Crossroad ADT = 100 vpd	2 lanes
Virginia	DHV = 500	DHV = 40 vph	2 lanes
	All	DHV = 120 vph	Design speed > 70 km/h (45 mph)
	DHV = 1,200 vph	DHV = 40 vph	4 lanes
	All	DHV = 90 vph	
West Virginia	DHV = 500 vph	DHV = 250 vph	Divided highways
Wisconsin	ADT = 2,500 vpd	Crossroad ADT = 1,000 vpd	2 lanes

Notes: DHV = design hourly volume; ADT = average daily traffic; vph = vehicles per hour; vpd = vehicles per day

Exhibit 11-19. Right-turn lane volume warrants.⁽⁴⁸⁾

Design features

The key design criteria for right-turn lanes are: entering taper; deceleration length; storage length; lane width; corner radius; and sight distance. *A Policy on Geometric Design for Highways and Streets* and agencies' policies describe the design criteria for selecting an appropriate right-turn lane length.⁽³⁾

Entering taper and deceleration length. Determine the entering taper and deceleration length based on vehicle speed. Design the storage length to accommodate the maximum vehicle queue expected for the movement under design year conditions. From a functional perspective, the entering taper should allow for a right-turning vehicle to decelerate and brake outside of the through traffic lanes. This is particularly important at higher vehicle speeds. In urban areas, this is often difficult to achieve and some deceleration of a turning vehicle is expected in the through travel lane.

Storage length. Make right-turn lanes sufficiently long to store the number of vehicles likely to accumulate during a critical period. The storage length should be sufficient to prevent vehicles from spilling back from the auxiliary lane into the adjacent through lane. At signalized intersections, the storage length required is a function of the cycle length, signal phasing arrangement, and rate of arrivals and departures. As a rule-of-thumb, design the auxiliary lane to accommodate 1.5 to 2 times the average number of vehicle queues per cycle, although methods vary by jurisdiction. See Chapter 7 for additional discussion regarding methodologies for estimating queue lengths/storage requirements.

In some cases, a right-turn lane may already exist, but increased traffic volumes may necessitate lengthening it, which can help improve operations and safety by providing additional storage for right-turning vehicles. If the length of a right-turn lane is inadequate, right-turning vehicles will spill back into the through traffic stream, thus increasing the potential for rear-end collisions. Longer entering tapers and deceleration lengths can reduce this potential.

Lane width. Lane width requirements for right-turn lanes are largely based on operational considerations. Generally, lane widths of 12 ft maximize traffic flow; however, right-of-way or pedestrian needs may dictate use of a narrower lane width. Consider restriping from 12 ft-lanes to narrower lanes in order to create more travel lanes where appropriate.⁽⁵⁷⁾ Exhibit 11-20 shows

an example from Montgomery County, MD, where a narrow right-turn lane has been used effectively.



Exhibit 11-20. Narrow (8 ft) right-turn lanes may be used effectively in retrofit situations.

Corner Radius. The corner radius influences the turning speed of vehicles. Large corner radii allow vehicles to turn at higher speeds. If low-speed, right-turn movements are desired, particularly in locations where pedestrian crossings occur, the curb radius should be minimized, yet still accommodate the turning path of the design vehicle. Pedestrian crossing distances will be minimized if curb radius is minimized. In addition, lower vehicle speeds can reduce the probability of a crash.

A larger curb radius is appropriate for situations where it is desirable for right-turning vehicles to exit the through traffic stream quickly. The right turn may operate as a free-flow movement if an acceleration lane is provided on the cross street, or the movement may be controlled by a yield sign where the turning roadway enters the cross street.

Increasing the turning radius can reduce the potential for sideswipe or rear-end collisions by reducing lane encroachments as a vehicle approaches a turn and as it enters the cross street. Also, some older drivers and drivers of large vehicles may have difficulty maneuvering; the rear wheels of their vehicles may ride up over the curb or swing out into other lanes where traffic may be present. For situations where a large turning radius is desired, the use of a channelization island may be appropriate to reduce unused pavement area. Unused pavement area contributes to driver confusion regarding the appropriate path through the intersection.

Sight distance. Adequate sight distance should be provided for vehicles in the right-turn lane or channelized right-turn movement. If right turns on red are permitted, drivers turning right should be able to view oncoming traffic from the left on the crossroad.

Safety Performance

Right-turn lanes are often used to preclude the undesirable effects resulting from the deceleration of turning vehicles. ITE's *Transportation and Land Development* indicates that a vehicle traveling on an at-grade arterial at a speed 10 mph slower than the speed of the normal traffic stream is 180 times more likely to be involved in a crash than a vehicle traveling at the normal traffic speed.⁽⁸⁹⁾ Right-turn channelization demonstrably reduces right-turn angle crashes. However, the addition of a right-turn lane may result in an increase in sideswipe crashes. From a vehicular operations standpoint, larger curb radii generally result in vehicle turning paths that are in line with the pavement edge. In addition, larger curb radii produce higher vehicle speeds that can negatively impact the safety of pedestrians and bicyclists.

The provision of right-turn lanes minimizes collisions between vehicles turning right and following vehicles, particularly on high-volume and high-speed major roads. A right-turn lane may

be appropriate in situations with an unusually high number of rear-end collisions on a particular approach. Installation of a right-turn lane on one major road approach at a signalized intersection is expected to reduce total crashes by 2.5 percent, and crashes are expected to decrease by 5 percent when right-turn lanes are constructed on both major-road approach.⁽¹⁹⁰⁾

Selected findings of safety benefits associated with various right-turn lane improvements are given in Exhibit 11-21.

Crash Modification Factor (CMF₃) for Installation of Right-Turn Lanes on Intersection Approaches

Intersection Type	Intersection traffic control	Number of approaches with right-turn lanes ^a			
		One approach	Two approaches	Three approaches	Four approaches
3 Approaches	Traffic signal	0.96	0.92	--	--
4 Approaches	Traffic signal	0.96	0.92	0.88	0.85

Exhibit 11-21. Safety benefits associated with right-turn improvements.
Source: Highway Safety Manual, Chapter 12.⁽¹¹⁾

Operational Performance

Right-turn lanes remove decelerating and slower-moving vehicles from the through traffic stream, which reduces delay for following through vehicles. Lin concluded that a right-turn lane may reduce vehicle delays substantially, even with the percentage of right-turns as low as 10 percent.⁽¹⁹³⁾

Installation of a right-turn lane can create other safety or operational problems at the intersection. For example, vehicles in the right-turn lane may block the cross street drivers' view of through traffic; a significant issue where right turns on red are permitted on the cross street. If a right shoulder is restriped to provide a turn lane, there may be adverse impacts on safety due to the decrease in distance to roadside objects. Carefully consider delineation of the turn lane to provide adequate guidance through the intersection.

If a right-turn lane is excessively long, through drivers may enter the lane by mistake without realizing it is a right-turn lane. Effective signing and marking the upstream end of the right-turn lane may remedy this.

Also, if access to a right-turn lane is blocked by a queue of through vehicles at a signal, drivers turning right may block the movement of through traffic if the two movements operate on separate phases. This could lead to unsafe lane changes and added delay.

Multimodal Impacts

The speed of turning vehicles is a risk to pedestrian safety.

The addition of a turn lane increases the crossing distance for pedestrians and may require additional time for the pedestrian change (upraised hand) interval phase. Other issues to consider when designing a right-turn lane include potential conflicts between turning vehicles and bicyclists proceeding through the intersection. Also, right-turning drivers from the inside right-turn lane might not see pedestrians in a parallel crosswalk that has a concurrent WALK signal.

Transit stops may have to be relocated from the near side of an intersection, due to possible conflicts between through buses and right-turning vehicles.

Physical Impacts

Addition of a right-turn lane will increase the footprint of the intersection, unless the shoulder is restriped to create a turn lane. The approach to the intersection will be wider to accommodate the auxiliary lane.

Designers should use caution when considering restriping a shoulder to provide or lengthen a right-turn lane. Part of the safety benefits of installing the turn lane may be lost due to loss of shoulder, the greater proximity of traffic to roadside objects, and a possible reduction in intersection sight distance.

Socioeconomic Impacts

Installing or lengthening a right-turn lane on an intersection approach may involve restricting right turns in and out of driveways on that approach. Techniques include signing or construction of a raised median.

The cost of construction (including relocation of signal equipment) and right-of-way acquisition is the main disadvantage to installation of a turn lane. Also, access to properties adjacent to the intersection approach may need to be restricted when a turn lane is installed.

Enforcement, Education, and Maintenance

Periodic enforcement may be needed to prevent red light violations, especially if right turns on red are prohibited.

Right-turn lanes are common, and minimal education should be needed to prepare drivers for their installation. Drivers may need a reminder that they should be watching for pedestrians crossing the departure lanes.

Maintenance issues for right-turn lanes will be the same as for other areas of the intersection. Pavement markings and signs should be kept visible and legible. Pavement skid resistance should be maintained.

Summary

Exhibit 11-22 summarizes the issues associated with right-turn lanes.

Characteristic	Potential Benefits	Potential Liabilities
Safety	Separation of right-turn vehicles.	Higher speed of right-turning vehicles increases risk to pedestrians.
Operations	Higher right-turn capacity. Shorter green time. Less delay for following through vehicles. Additional storage for approach queues.	Potential for off-tracking of large vehicles.
Multimodal	None identified.	Longer pedestrian crossing distance, time, and exposure. May require transit stop relocation.
Physical	None identified.	Larger intersection footprint.
Socioeconomic	None identified.	Right-of-way/construction costs. Access restrictions to property.
Enforcement, Education, and Maintenance	None identified.	Periodic enforcement may be needed to prevent red light violations, especially if right turns on red are prohibited.

Exhibit 11-22. Summary of issues for right-turn lanes.

11.2.3 Provide Double Right-Turn Lanes

High volumes of right-turning vehicles may support double right-turn lanes to increase capacity for the turns and reduce delay for other movements at the intersection. Double right-turn lanes can reduce both the length needed for turn lanes and the green time needed for that movement.

Approaches with right-turn volumes that cannot be accommodated in a single turn lane without excessively long green times (and delays for other approaches) may be appropriate locations for double turn lanes. Also, locations where right-of-way is not available to provide a long turn lane but there is space for two shorter turn lanes may be ideal for double turn lanes. Clearly, multiple turn lanes are not appropriate where only one receiving lane is available; however, consideration may be given to providing a departing auxiliary lane to allow for double right turns with a downstream merge.

As with single right-turn lanes, the design vehicle should be considered when determining length, width, and taper of the turn lane. The receiving lane should accommodate the turning radius of a large vehicle. Delineation of the turn path will guide drivers through the maneuver and help reduce crossing over into adjacent lanes while turning.

Based on the subjective assessment of the authors, the safety experience of double right-turn lanes should be similar to that of single right-turn lanes. Rear-end collisions of decelerating right-turn vehicles and following through vehicles may be reduced after construction of the additional turn lane, because the turn lanes have a higher capacity for the slower vehicles. Even though the double turn lanes increase capacity, some deceleration may occur in the through lanes, depending on the length of the turn lanes. This could lead to rear-end crashes.

Sideswipes between turning vehicles are a possibility at double turn lanes. This is especially an issue if the turn radius is tight and large vehicles are likely to be using the turn lanes. Delineation of turn paths should help address this.

Construction of an additional right-turn lane can be reasonably expected to improve the operation of the intersection, provided that the affected right-turn movement is a critical movement. The additional deceleration and storage space should help prevent spillover into adjacent through lanes. Less green time should be needed for right-turn traffic, and this time thus can be allocated to other movements. However, a double turn lane will result in a wider footprint for the intersection and increase the distance pedestrians must cross, which increases their exposure to potential conflicts with vehicular traffic.

Acquisition of right-of-way to provide an additional turn lane may be expensive. If a departure auxiliary lane is to be constructed to allow for a downstream merge, this may also increase right-of-way costs. Access to adjacent properties may need to be restricted to provide a merge area. Owners of adjacent property should be involved in early discussions regarding the plans.

Lane use signing and signs prohibiting right turns on red from the inside turn lane should convey all the information that drivers would need. In some cases the outside lane will be handled with yield control while the inside right-turn lane is under signal control. Periodic enforcement may be needed to ensure drivers obey any right turn on red prohibitions.

Summary

Exhibit 11-23 summarizes the issues associated with double right-turn lanes.

Characteristics	Potential Benefits	Potential Liabilities
Safety	Separation of right-turn vehicles.	Potential for sideswipes.
Operations	Higher right-turn capacity. Shorter green time. Less delay for following through vehicles.	Off-tracking of large vehicles.
Multimodal	None identified.	Longer pedestrian crossing distance, time, and exposure.
Physical	Potentially shorter intersection footprint than needed for single turn lane.	Wider intersection footprint.
Socioeconomic	None identified.	Right-of-way costs. Access restrictions to property.
Enforcement, Education, and Maintenance	None identified.	None identified.

Exhibit 11-23. Summary of issues for double right-turn lanes.

11.2.4 Restricting Turns, U-Turns

One of the easiest methods to improve the operation of signals is reducing the number of phases or movements. Typically, these restrictions relate to a turning movement; however, any movement like through movements from the minor street could be restricted. Safety and operations at some signalized intersections can be enhanced by restricting turning maneuvers, particularly left turns, during certain periods of the day (such as peak traffic periods) or by prohibiting particular turning movements altogether. Signing or channelization can be implemented to restrict or prohibit turns at intersections.

Prohibiting or restricting left turns should practically eliminate crashes related to the affected turning maneuver. Analyze alternative routes to ensure crash rates and operational problems do not increase due to diversion of traffic to these alternatives. Also, the benefit of restricting turns may be reduced by an increase in accidents related to formation of queues (rear-end collisions).

Restricting right turns on red is a commonly done due to the number of pedestrians crossing at the intersection. Certain vehicles, such as school buses, have policies in place to prohibit drivers from turning right on red. The HSM equation 12-35 calculates a CMF using this formula: $CMF = 0.98^n$, in which n is the number of approaches that have the prohibition.

The key to success is how well the prohibition is communicated through signing, marking, and may require public outreach to inform drivers.

Managing access near signals is often problematic. Adding medians and restricting existing entrances to right in, right out can improve operational efficiency. Providing a U-turn at the signal for access can help offset these restrictions. Note that U-turning vehicles proceed through an intersection at a slower speed than left-turning vehicles and can adversely affect both operations and safety at the intersection. Consider prohibition of U-turns at intersections with high volumes of movement with which U-turns interfere. Slower moving U-turning traffic will reduce the capacity of a left-turn movement. Drivers attempting to make a U-turn during a permitted left-turn phase may interfere with opposing through traffic. Rear-end crashes involving U-turning vehicles followed by left-turning or through vehicles may be a sign of operational problems with the U-turn maneuver.

Consider sight distance limitations. If opposing left-turning vehicles waiting in a turn lane block a U-turning driver's view of oncoming through traffic, prohibition of U-turn (as well as left-turn) maneuvers on a permissive left-turn phase may be appropriate.

Accommodate the turning radius of the design vehicle by a combination of median and receiving lane width. A shorter turn radius will cause slower speeds for U-turning vehicles, and will result in more delay to following vehicles.

One study suggests adjusting for U-turns differently from left-turns when determining saturation flow rates of left-turn lanes, to account for their larger effect on operations.⁽¹⁹⁴⁾

Summary

Exhibit 11-24 summarizes the issues associated with turn prohibitions.

Characteristic	Potential Benefits	Potential Liabilities
Safety	Potential reduction in collisions.	None identified.
Operations	Potential increase in capacity and reduction in delay due to reduction of the number of phases.	Could adversely affect adjacent intersections.
Multimodal	Fewer conflicts with turning vehicles. Lower delay to all users.	None identified.
Physical	Could reduce the footprint of intersection.	Upkeep of delineators, marking, and islands to restrict movements.
Socioeconomic	Part of a traffic calming measure while enhancing main street efficiency. Reduce emissions.	Impacts from adverse travel.
Enforcement, Education, and Maintenance	None identified.	Enforcement of turn restrictions may be needed.

Exhibit 11-24. Summary of issues for turn prohibitions.

11.2.5 Provide Auxiliary Through Lanes

Adding auxiliary through lanes (i.e., additional through lanes with limited length) at signalized intersections can provide added capacity for through movements. The amount of added capacity achieved depends on the extent to which through vehicles use the auxiliary lane. Various factors (such as the length of the auxiliary lane, turn volumes, and overall operation of the intersection) contribute to how many vehicles will use an auxiliary lane.

Description

Auxiliary lanes are generally provided on the approaches of a signalized intersection in advance of the intersection, reduced downstream of the intersection, or dropped at a subsequent intersection. Right-turn traffic may share the outside lane with a portion of the through vehicles, or there may be a separate exclusive right-turn lane. The auxiliary lane may also serve as an acceleration lane for vehicles turning right from the adjacent approach. Exhibit 11-25 illustrates an auxiliary through lane.

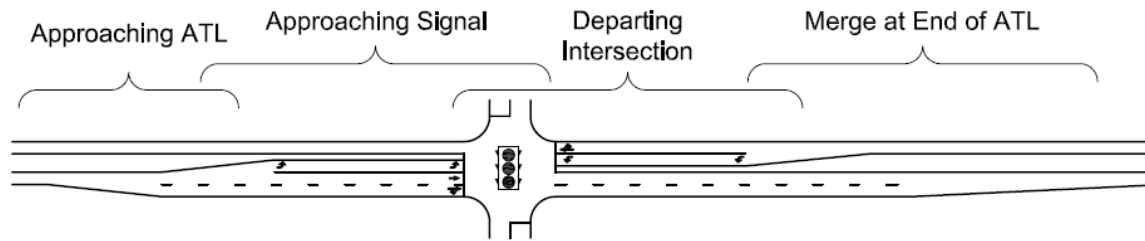

Exhibit 11-25. Diagram of an auxiliary through lane.
Source: NCHRP Report 707.⁽¹⁹⁵⁾

Applicability

Auxiliary through lanes are applicable for arterials that have adequate capacity along midblock segments but require additional capacity at signalized intersection locations. The full benefit of an auxiliary through lane will not be realized if a bottleneck or constraint exists on the arterial upstream or downstream of the intersection.

Design Features

The length of the auxiliary through lane on both sides of an intersection helps determine whether the lane will be used; longer lanes get more use by through vehicles than do shorter ones. Ideally, the lane should be of sufficient length to allow a smooth merge once the lane is reduced.

Clearly communicating when the lane will end also determines how well the auxiliary lane will be used.⁽¹⁹⁶⁾ The reduction of the auxiliary lane downstream should be signed and marked according to the MUTCD.⁽¹⁾ If not properly signed and marked, motorists can become trapped near the end of the reduced lane, without advance notice of the reduction. Therefore, particular attention should be made to discontinuing the lane line at the $\frac{3}{4}d$ distance from the end of the full width lane (see MUTCD Figure 3B-14). Note that "d", placement of the warning sign, is found in MUTCD Table 2C-4.

Operational Features

Unless a separate right-turn lane is provided, both through and right-turning vehicles may use the additional lane. More vehicles are likely to use the auxiliary through lane if there is not adequate green time to clear the signal from the inside through lane. Using relatively short green times for the approach will clear vehicle queues and likely result in a higher utilization of the outside auxiliary through lane due to compressed gaps in the through movement.

Safety Performance

Based on the subjective assessment of the authors, the safety experience of an intersection with auxiliary through lanes should not significantly differ from conventional intersections without the additional lane. The downstream merge maneuver this design requires may lead to an increase in merge-related collisions (sideswipes), but studies have not evaluated this.

Again, the length of the auxiliary through lane impacts the safety of the intersection. Drivers not comfortable with an auxiliary lane will stay in the through lane. No reduction in rear end crashes at the signal should be expected. Right-turning vehicles off the minor street may conflict with the vehicles on the main street using the auxiliary lane. The right-turning vehicles may use the auxiliary lane as an acceleration lane and not properly yield to the major street. This could lead to right turn, right angle crashes or right turn rear end crashes.

NCHRP 707 lists the following elements as critical to its safe operation:⁽¹⁹⁵⁾

- Downstream length should be sufficient to allow enough acceleration to merge back into through movement easily.

- Access control is necessary to reduce the number of conflicting movements along the lane.
- Sight distance should be adequate to view all signing, marking, merge area, and judge traffic flow.
- Queuing downstream of the auxiliary through lane merge should be prevented if possible from bottlenecks.
- Taper design should match AASHTO Green Book standards.
- Signing, marking, and lighting of the auxiliary through lane should be in accordance with MUTCD guidelines, should be clear and concise, and should accommodate nighttime operations.

Operational Performance

NCHRP 707 contains a step by step procedure to estimate the usage of a proposed auxiliary lane. This example is for the additional of a single auxiliary lane adjacent to a single, continuous through lane.⁽¹⁹⁵⁾

$$X_T = \frac{V_T}{S_T \times \frac{g}{C}}$$

- where:
- V_T = 15 - minute through - movement demand flow rate on the approach, expressed in vehicles per hour;
 - S_T = A adjusted through saturation flow rate per lane on the approach, in vehicles per hour;
 - g = Effective green time for the approach, in seconds; and
 - C = Intersection cycle length, in seconds.

$$V_{ATL} = 20.226 + 81.791 \times X_T^2 + 1.65 \times \frac{V_T^2}{10,000}$$

- where: V_{ATL} = The predicted through movement flow rate in the auxiliary through lane (in vehicles per hour), and all other variables are as previously defined.

Remaining volume traveling in the continuous through lanes is $V_{CTL} = V_T - V_{ATL}$.

Multimodal Impacts

Wider intersections result in longer crossing times for pedestrians and bicyclists, as well as increased exposure to vehicle conflicts.

Physical Impacts

Adding an auxiliary through lane will increase the footprint of the intersection if no median is currently present. The approach to the intersection will be wider to accommodate the auxiliary lane.

Socioeconomic Impacts

Driver perception of the benefits of the auxiliary through lane will determine how often the lane is used by through vehicles. If right-turn volumes are high enough that drivers do not benefit from using the lane, capacity of the through movement will not improve significantly.

The cost of construction and the accompanying signing and striping are among the main economic disadvantages to installation of an auxiliary lane. Also, access to properties adjacent to the intersection approach should be restricted when another lane is constructed. Property owners affected by the restrictions, especially business owners, may be opposed to the auxiliary lanes.

Enforcement, Education, and Maintenance

Auxiliary through lanes do not present any special enforcement issues.

No public education should be needed to inform drivers how to proceed through the intersection. Only critical, location-specific signs should be located within the downstream auxiliary through lane area due to the merge and reduction demand on the driver. Markings and signing for lane use and arrangement are generally sufficient upstream, and lane reduction signing and markings are sufficient downstream.

Maintenance issues for through auxiliary lanes will be the same as for other areas of the intersection. Pavement markings and signs should be kept visible and legible.

Summary

Exhibit 11-26 summarizes the issues associated with auxiliary through lanes.

Characteristic	Potential Benefits	Potential Liabilities
Safety	May reduce rear-end crashes due to improved signal operation.	Potential for sideswipes downstream of merge. Right-turn crashes with minor street.
Operations	Decreased delay for through vehicles.	Improper use of auxiliary lane downstream; under use of auxiliary lane upstream.
Multimodal	Reduces queues may decrease overall cycle length	Longer pedestrian crossing time and exposure.
Physical	None identified.	Larger intersection footprint.
Socioeconomic	None identified.	Construction costs. Driver perception of delay. Access to properties.
Enforcement, Education, and Maintenance	None identified	Enforcement responding to crashes from rear ends and side swipes. Right-turning drivers not yielding to through movement.

Exhibit 11-26. Summary of issues for auxiliary through lanes.

11.2.6 Delineate Through Path

At complex intersections where the correct path through the intersection may not be immediately evident to drivers, pavement markings may be needed to provide additional guidance. The same markings are used to delineate turning paths through intersections for multiple turn lanes. These markings are a continuation of the longitudinal lane stripes, but have a different stripe and skip pattern. An example of these markings is given in Exhibit 11-27.

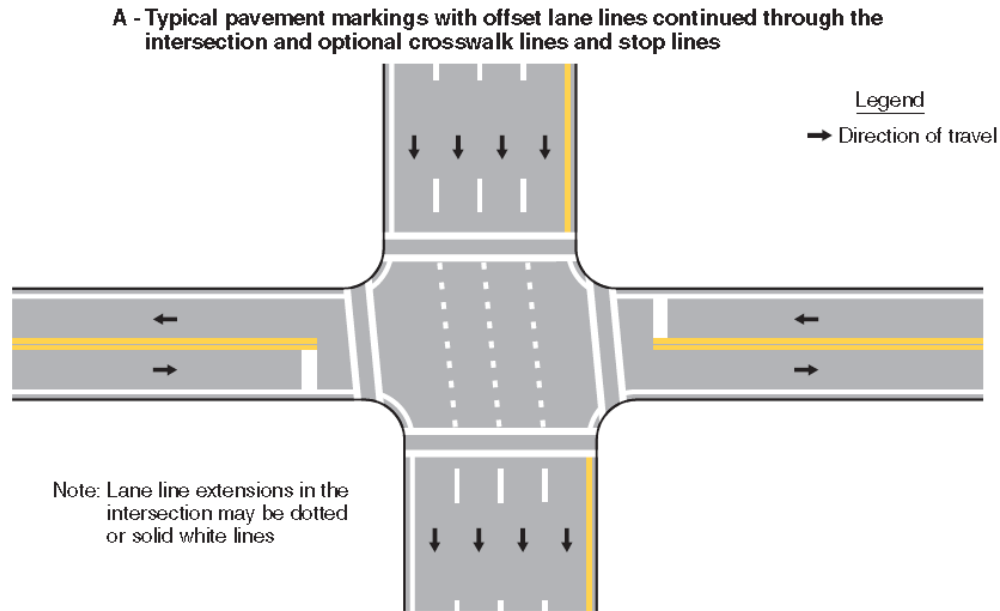

Exhibit 11-27. Example of delineated paths.
Source: MUTCD 2009 Fig 3B-13.⁽¹⁾

Intersections where through vehicles cannot proceed through the intersection in a straight line may benefit from pavement markings that guide drivers along the appropriate path. Skewed intersections, intersections where opposing approaches are offset, and multi-leg intersections may all present situations where additional guidance can improve safety and operations.

Delineating the through path should help reduce driver confusion in the intersection, which will reduce erratic movements as drivers steer into or out of the appropriate path. This would reduce the potential for sideswipe, rear-end, and head-on crashes.

Pavement markings through the intersection should account for off-tracking of large (design) vehicles. The markings should be spaced far enough apart to allow off-tracking without crossing over the markings.

The cost of installing and maintaining the pavement markings should be the only costs of this treatment, and should be similar to that of other pavement markings on the approaches.

Summary

Exhibit 11-28 summarizes the issues associated with path delineation.

Characteristic	Potential Benefits	Potential Liabilities
Safety	Fewer erratic maneuvers.	None identified.
Operations	Fewer erratic maneuvers.	None identified.
Multimodal	None identified.	Potential off-tracking of large vehicles.
Physical	None identified.	Installation costs.
Socioeconomic	None identified.	Maintenance costs.
Enforcement, Education, and Maintenance	None identified.	None identified.

Exhibit 11-28. Summary of issues for path delineation.

11.3 VARIABLE LANE USE TREATMENTS

11.3.1 Provide Reversible Lanes

Reversible lanes increase capacity without additional widening when flows during peak periods are highly directional. These peak periods could be regular occurrences, as with normal weekday morning and evening peak traffic, or with special events, as with roadways near major sporting venues. Reversible lanes often extend for a considerable length of an arterial through multiple signalized intersections.

According to the MUTCD, reversible lanes are governed by signs (Section 2B.25) and/or the following lane use control signals (section 4J.02):⁽¹⁾

- DOWNWARD GREEN ARROW.
- YELLOW X.
- WHITE TWO-WAY LEFT-TURN ARROW.
- WHITE ONE-WAY LEFT-TURN ARROW.
- RED X.

At least three sources provide good information on the implementation of reversible lanes. First, the MUTCD provides guidance on the allowable applications of these lane use control signs and signals, as well as when lane use signals should be used instead of signs. Second, the *Traffic Control Devices Handbook* provides additional information on signal control transition logic that can be used when reversing the directional flow of a lane or changing a lane to or from two-way left-turn operation.⁽⁶⁸⁾ Third, the *Traffic Safety Toolbox* provides further discussion on planning and implementation considerations, in addition to a discussion of the effects on capacity and safety.⁽¹⁰⁾

Safety Performance

Reversible lanes help reduce congestion and likely reduce rear-end collisions. As reported in the *Traffic Safety Toolbox*, “Studies of a variety of locations where reversible lanes have been implemented have found no unusual problem with head-on collisions compared to other urban facilities. Typically, the reversible lanes will have either no effect on safety conditions or will achieve small but statistically significant reductions in accident rates on the facility.”^(10, p. 130)

Reversible lanes may preclude the use of median treatments as an access- management technique along an arterial street.

Operational Performance

Reversible lanes directly benefit operational performance by allowing better matching of the available right-of-way to peak direction demands.

Multimodal Impacts

The operation of a reversible lane precludes the use of a fixed median to physically separate opposing travel directions. Therefore, reversible lane operation precludes the use of medians as a refuge area for pedestrians, thus requiring pedestrians to cross the arterial in one stage.

Physical Impacts

Reversible lanes may postpone or eliminate the need to widen a facility.

Socioeconomic Impacts

Reversible lanes are a relatively low-cost treatment compared to the cost of physically widening a facility. This type of facility may not be viewed as conducive to the type of development along the route.

Summary

Exhibit 11-29 summarizes of the issues associated with reversible lanes.

Characteristics	Potential Benefits	Potential Concerns
Safety	Typically achieves small but statistically significant accident reductions due to reduced congestion.	May preclude access management techniques.
Operations	Provides additional capacity to accommodate peak direction flows.	Potential confusion by drivers during off peak times.
Multimodal	None identified.	Reversible lanes may prevent the use of median pedestrian refuges.
Physical	May postpone or eliminate the need to widen a facility.	None identified.
Socioeconomic	Relatively low cost.	May not be compatible with adjacent property uses.
Enforcement, Education, and Maintenance	None identified.	New treatment to the area would require some communication.

Exhibit 11-29. Summary of issues for reversible lanes.

11.3.2 Provide Variable Lane Use Assignments

The concept of variable lane use treatments at signalized intersections is similar to that of the reversible lane but is typically applied locally to a single intersection. Variable treatments change individual lane assignments at a signalized intersection by time of day and thus can be used to accommodate turning movements with highly directional peaking characteristics.

Issues to consider when implementing variable lane use assignments include: ⁽⁵⁷⁾

- Adequate turning radius for the number of turning lanes intended during each mode of operation.
- Adequate receiving lanes for each mode of operation.
- Compatible signal phasing to accommodate each lane configuration.

- The use of similar variable advance lane use signs to provide adequate notice to drivers of the lane use in effect.

Impacts to signal timing and phasing require special attention when implementing variable lane use assignments. Variable lane assignments should be evaluated using traffic software and simulations. While not necessary for all variable lane use operations, split phasing allows any legal combination of lanes to be implemented, provided that the other factors cited above are accommodated. Other techniques that could be used include variable left-turn phasing treatments (e.g., protected-only operation during some times of day, and protected-permissive operation during others). Today's traffic software and simulation programs allow the practitioner to evaluate different scenarios prior to implementing this strategy on the street.

Exhibits 11-30 and 11-31 provide examples from Montgomery County, Maryland, where variable lane use signs have been provided for additional left and right turns, respectively. These signs have been employed in conjunction with advance variable lane use signs provided several hundred feet before the intersection. The signs are compliant with the MUTCD, which allows changeable message signs to use the reverse color pattern when displaying regulatory messages (Sections 2A.07 and 6F.52).⁽¹⁾ They are reported as being well received by the public and effective in reducing peak-period queuing.⁽⁵⁷⁾



(a) Double left turn during morning peak and off-peak periods.



(b) Triple left turn during evening peak period.

Exhibit 11-30. Example use of variable lane use sign to add a third left-turn lane during certain times of day.



Exhibit 11-31. Example use of variable lane use sign to add a second right-turn lane along a corridor during certain times of day.

Summary

Exhibit 11-32 summarizes the issues associated with variable lane use.

Characteristics	Potential Benefits	Potential Concerns
Safety	None identified.	None identified.
Operations	Improved peak-period utilization of existing right-of-way. Reduced queuing during peak periods.	None identified.
Multimodal	None identified.	Barrier to adding bike lanes.
Physical	Reduces or eliminates need for additional right-of-way.	None identified.
Socioeconomic	Lower cost than adding lanes.	None identified.
Enforcement, Education, and Maintenance	None identified.	Communicate any changes to the public. Maintain additional equipment

Exhibit 11-32. Summary of issues for variable lane use.

List of Acronyms

AADT	Average Annual Daily Traffic
AASHTO	American Association of State Highway and Transportation Officials
ADA	Americans with Disabilities Act
ADAAG	Americans with Disabilities Act Accessibility Guidelines
ADT	Average Daily Traffic
ATC	Advanced Transportation Controller
BCR	Benefit-Cost Ratio
BIU	Bus Interface Unit
CLA	Critical Lane Analysis
CMF	Crash Modification Factor
CW	Continuous Wave
EB	Empirical Bayes
EPDO	Equivalent Property Damage Only
FARS	Fatality Analysis Reporting System
FHWA	Federal Highway Administration
GPS	Global Positioning System
HCM	Highway Capacity Manual
HSIS	Highway Safety and Information System
HSM	Highway Safety Manual
IESNA	Illuminating Engineering Society of North America
ITE	Institute for Transportation Engineers
ITS	Intelligent Transportation Systems
LED	Light Emitting Diode
LOS	Level of Service
MMU	Malfunction Management Unit
MMUCC	Model Minimum Uniform Crash Criteria
mph	mile(s) per hour
MUTCD	Manual on Uniform Traffic Control Devices
NCHRP	National Cooperative Highway Research Program
NEMA	National Electrical Manufacturers Association
NHTSA	National Highway Traffic Safety Administration
NTCIP	National Transportation Communication for ITS Protocol
PDO	Property Damage Only
PHB	Pedestrian Hybrid Beacons

PPLT	Protected-Permissive Left-Turn
PROWAG	Public Rights of Way Accessibility Guidelines
PSI	Potential for Safety Improvement
QEM	Quick Estimation Method
RF	Radio Frequency
RSA	Road Safety Audit
RSI	Relative Severity Index
SCP	Signal Control and Prioritization
SDLC	Synchronous Data Link Control
SPF	Safety Performance Function
SPUI	Single Point Urban Intersection
SSAM	Surrogate Safety Analysis Model
STV	Small Target Visibility
SUV	Sport Utility Vehicle
TCQSM	Transit Capacity and Quality of Service Manual
TRB	Transportation Research Board
UPS	Uninterrupted Power Supply
USDOT	United States Department of Transportation
v/c	Volume-to-Capacity

Glossary of Terms

Actuated Signals: Vary the amount of green time allocated to each phase based on traffic demand. Can operate either in a fully actuated mode, semi-actuated mode, or coordinated mode.

Advance Stop Lines: Vehicle stop lines moved 5 to 10 m (15 to 30 ft) further back from the pedestrian crossing than the standard 1.2 m (4 ft) distance to improve visibility of through bicyclists and crossing pedestrians for motorists who are turning right.

All-way Stop control: Requires that vehicles approaching the intersection from all directions come to a stop prior to entering the intersection.

Americans with Disabilities Act (ADA): Law passed in 1990 that prohibits discrimination and ensures equal opportunity and access for persons with disabilities (<http://www.fta.dot.gov/civilrights/12325.html>).

Auxiliary Lane: A lane added in advance of (and sometimes carried through) an intersection for a limited distance to facilitate speed change (acceleration or deceleration), added capacity (throughput), separate turning or weaving.

Back-of-Queue: The maximum backward extent of queued vehicles during a typical cycle.

Before and After Study: Crash frequencies at a site are compared before and after implementation of a treatment.

Benefit-Cost Ratio (BCR) Method: First the present worth of benefits and costs is calculated. Then the ratio of present worth of benefits over present worth of costs is calculated. If the ratio is greater than 1.0, the project is economically justified.

Bicycle Box: Advance stop lines are placed on the approach to a signalized intersection, typically in the rightmost lane, at a location upstream from the normal stop line location. These create a dedicated space for bicyclists—a bicycle box—to occupy while waiting for a green indication.

Capacity: The maximum sustainable flow rate at which vehicles can pass through a given point in an hour under prevailing conditions; it is often estimated based on assumed values for saturation flow, and width of lanes, grades, and lane use allocations, as well as signalization conditions.

Change and Clearance Interval: The amount of time, in seconds, based on speed and corresponding to distance, provided for vehicles to either stop at or clear an intersection (refer to ITE Recommended Practice).

Crash Modification Factor (CMF): The ratio of expected crash frequency at a location with a countermeasure divided by the expected crash frequency at the location without the countermeasure.

Critical Phase: One phase of a set of phases that occur in sequence and whose combined flow ratio is the largest for the signal cycle.

Cut-through Median: A median on which the pedestrian path is at the same grade as the adjacent roadway.

Curb Extensions (also known as “Bulbouts” or “Neckdowns”): Involve extending the sidewalk or curb line into the street, reducing the effective street width.

Curb Ramp: A ramp leading from a sidewalk to a street to provide access for people who use wheelchairs and scooters.

Cycle Length: The time allotted or used for one complete sequence of signal indications.

Decision Sight Distance: The distance needed for a driver to detect an unexpected or otherwise difficult-to-perceive information source or condition in a roadway environment that may be visually cluttered, recognize the condition or its potential threat, select an appropriate speed and path, and initiate and complete the maneuver safely and efficiently.

Delay: The additional travel time experienced by a driver, passenger, bicyclist, or pedestrian beyond that is required to travel at the desired speed, including stop and start-up time.

Detectable Warning: A surface of truncated domes built in or applied to walking surfaces to alert visually impaired pedestrians of the presence of the vehicular travel way and to provide physical cues to assist pedestrians in detecting the boundary from sidewalk to street.

Detectors (also called Sensors): Inform the signal controller that a motor vehicle, pedestrian, or bicycle is present at a defined location on the approach to an intersection or within a signal system.

Dilemma Zone: Length of roadway in advance of an intersection wherein drivers may be indecisive and respond differently to the onset of a yellow signal.

Dilemma Zone Detection System: Uses detectors placed at one or more locations on an intersection approach to extend the green and prevent the onset of yellow while approaching vehicles are in the dilemma zone.

Disability Glare: The glare that results when stray light is superimposed in the eye on top of the retinal image of the object of interest, altering the apparent brightness of that object and the background in which it is viewed.

Dropped Lane: A through lane that becomes a left- or right-turn lane at an intersection.

Effective Green Time: The amount of usable time available to serve vehicular movements during a phase of a cycle.

Empirical Bayes (EB) Method: Calculates expected crash frequencies through a combination of observed and predicted crash frequencies. The predicted crash frequencies are derived through the development of a safety performance function (SPF).

Exclusive Pedestrian Signal Phase: Allows pedestrians to cross in all directions at an intersection at the same time, including diagonally. Sometimes called a “Barnes dance” or “pedestrian scramble.”

Far-side Transit Stop: A transit stop located downstream of an intersection.

Forgiving Roadway: An information-driven concept predicated on meeting the expectations of road users—motorists, bicyclists, and pedestrians—and assuring that they get needed information, when it is required, in an explicit and usable format, in sufficient time to react.

Fully-actuated Signals: Traffic signals that recognize users on all approaches.

Gap Reduction: A predetermined, constant time (often fraction of a second) which is subtracted from the maximum extension or passage time beginning at a point after the initial or minimum green has timed out.

Highway Safety Manual (HSM): An American Association of State Highway Transportation Officials (AASHTO) document that provides tools to practitioners to conduct quantitative safety analyses.

Human Factors Research: Deals with human physical, perceptual, and cognitive abilities and characteristics and how they affect our interactions with tools, machines, and workplaces.

Illuminance: The amount of light incident on the pavement surface from the lighting source.

Intersection Count: Number of vehicles entering a signalized intersection. This is often counted by turning movement and direction of travel.

Intersection Sight Distance: The distance required for a driver without the right of way to perceive and react to the presence of traffic signal indications, conflicting vehicles, and pedestrians.

Lagging Pedestrian Interval: Retiming the signal splits so that the pedestrian WALK signal begins a few seconds after the vehicular green for turning movement.

Leading Pedestrian Interval: Retiming the signal splits so that the pedestrian WALK signal begins a few seconds before the vehicular green. While the vehicle signals are in "All Red," this allows pedestrians to establish their presence in the crosswalk before the turning vehicles, thereby enhancing the pedestrian right-of-way.

Light Level: Represents the intensity of light output on the pavement surface. Reported in units of lux (metric) or footcandles (U.S. Customary).

Lost Time: The unused portion of a vehicle phase that occurs twice during a phase: at the beginning when vehicles are accelerating from a stopped position, and at the end when vehicles decelerate in anticipation of the red indication; often calculated as the sum of start-up loss and clearance interval.

Luminance: The amount of light reflected from the pavement toward the driver's eyes.

Manual on Uniform Traffic Control Devices (MUTCD): A compilation of national standards for all traffic control devices, including traffic signals.

Maximum Green Time: The maximum limit to which the green time can be extended for a phase in the presence of a call from a conflicting phase.

Near-side Transit Stop: A transit stop located upstream of an intersection.

Pedestrian Hybrid Beacon (PHB): A special type of traffic control device used to warn and control traffic at an unsignalized location to assist pedestrians in crossing a street or highway at a marked crosswalk.

Pedestrian Signal Detector: Devices to help pedestrians, including those with visual or mobility impairments, activate the pedestrian phase, such as pushbuttons or other passive detection devices.

Permissive-only Left-Turn Phasing (also called "Permitted-Only" Phasing): Signal phasing that allows two opposing approaches to time concurrently, with left turns allowed after motorists yield to conflicting traffic and pedestrians.

Positive Guidance: Concept that focuses on understanding and making allowances for how road users—primarily motorists—acquire, interpret, and apply information in the driving task.

Potential for Safety Improvement (PSI): The difference between expected crashes (obtained from the Empirical Bayes method) and predicted crashes (obtained from safety performance functions).

Preemption: Primarily related to the transfer of the normal control (operation) of traffic signals to a special signal control mode for the purpose of servicing railroad crossings, emergency vehicle passage, mass transit vehicle passage, and other special tasks, the control of which requires terminating normal traffic control to serve the special task.

Presence Detection: Alerts the controller to waiting vehicles during the red interval and calls for additional green time (passage or extension) for moving vehicles during the green interval.

Pre-timed Signals: Traffic signals that are programmed to give green indications to movements based on a predetermined allocation of time. Operate with fixed cycle lengths and green splits, and in turn can operate either in an isolated or coordinated mode.

Priority: The preferential treatment of one vehicle class (such as a transit vehicle, emergency service vehicle, or a commercial fleet vehicle) over another vehicle class at a signalized intersection without causing the traffic signal controllers to drop from coordinated operations.

Progression: The movement of vehicle platoons from one signalized intersection to the next.

Prohibited Left-Turn Movements: A scenario under which left-turning drivers are required to divert to another facility or turn in advance of or beyond the intersection via a geometric treatment such as a jughandle or a downstream median U-turn.

Protected-only Left-Turn Phasing: Signal phasing that provides a separate phase for left-turning traffic and allowing left turns to be made only on a green left arrow signal indication, with no pedestrian movement or vehicular traffic conflicting with the left turn.

Protected-Permissive Left-Turn (PPLT) Phasing: A combination of protected and permissive left-turn phasing.

Public Rights of Way Accessibility Guidelines (PROWAG): Guidelines developed specifically for pedestrian facilities in the public right-of-way that address conditions and constraints that exist in the public right-of-way.

Pulse Detection: A type of detection located well upstream of the intersection to provide inputs to the controller regarding approaching vehicles.

Queue Storage Ratio: The proportion of the available queue storage distance that is occupied at the point in the cycle when the back-of-queue position is reached.

Ramped Median: A median on which the pedestrian path is raised to the grade of the top of the curb.

Red Clearance Interval: Optional interval that follows the yellow change interval and precedes the next conflicting green interval. Provides additional time following the yellow change interval before conflicting traffic is released.

Red Light Running: When a motorist enters an intersection when the red signal is displayed and as a consequence sometimes collides with another motorist, pedestrian, or bicyclist who is legally within the intersection.

Red-Red Flashing Operation: A mode of flashing operation in which all approaches receive a flashing red indication. Typically used where traffic volumes on all approaches are roughly the same.

Red-Yellow Flashing Operation: A mode of flashing operation in which the minor street receives a flashing red indication and the major street receives a flashing yellow indication. Used in situations where traffic is very light on the minor street.

Ring-and-Barrier Structure: Signal phasing that prohibits conflicting movements (e.g., eastbound and southbound through movements) from timing concurrently while allowing non-conflicting movements (e.g., northbound and southbound through movements) to time together.

Road Safety Audit (RSA): A formal safety performance examination of an existing or future road or intersection by an independent audit team that considers the safety of all road users and qualitatively estimates and reports on road safety issues and opportunities for safety improvement.

Road Safety Management Process: Systematically identifying deficient locations from safety perspectives and addressing safety problems of these locations.

Roundabout: A circular intersection with design features that promote safe and efficient traffic flow.

Safety Performance Function: An equation that presents the mathematical relationship between crash frequency and volume for a reference group.

Safety Effectiveness Evaluation: The process of developing quantitative estimates of how a countermeasure, project, or a group of projects has affected crash frequencies or severities.

Semi-actuated Signals: Traffic signals that use various detection methods to identify roadway users on the minor approaches and/or major approach left-turn lanes.

Signal Interval: The part of the signal cycle during which signal indications do not change.

Signal Phase: The right-of-way, yellow change, and red clearance intervals in a cycle that are assigned to an independent traffic movement or combination of traffic movements.

Signal Phasing: The sequence of individual signal phases or combinations of signal phases within a cycle that define the order in which various pedestrian and vehicular movements are assigned the right-of-way.

Split Phasing: Signal phasing that consists of having two opposing approaches time consecutively rather than concurrently (i.e., all movements originating from the west followed by all movements from the east).

Small Target Visibility (STV): The level of visibility of an array of targets on the roadway. Determined by the average of three components: the luminance of the targets and background, the adaptation level of adjacent surroundings, and the disability glare.

Stopping Sight Distance: The distance along a roadway required for a driver to perceive and react to an object in the roadway and to brake to a complete stop before reaching that object.

System Detection: A collection of vehicular data such as count, speed, occupancy, queue length used by the controller to order and recall special override timing plans, traffic responsive timing plans, and adaptive signal control.

Traffic Demand: For an intersection, traffic demand represents the arrival pattern of vehicles.

Traffic Signals: Electrically operated traffic control devices that provide indication for roadway users to advance their travels by assigning right-of-way to each approach and movement.

Traffic Signal Controller: Acts as the “brain” of a traffic signal, changing signal indications based on user needs. The controller determines when the indication for the approach will change and how much time will be given to each movement.

Traffic Signal Heads: Informs roadway users of when their movement can proceed through the intersection. Signal heads vary in configuration, shape, and size depending on the movement for which they are used.

Traffic Volume: For an intersection, traffic volume is generally measured as the number of vehicles that pass through the intersection over a specific period of time.

Uniformity: Represents the ratio of either the average-to-minimum light level (E_{avg}/E_{min}) or the maximum-to-minimum light level (E_{max}/E_{min}) on the pavement surface.

Variable Initial: A volume-density feature used to improve intersection efficiency by using each pulse detector actuation during the red interval, typically on the major through approach, to incrementally alter the minimum green time in order to clear the accumulated queue for each cycle.

Variable Lane Use Treatments: Individual lane assignments at a signalized intersection are changed by time of day.

Veiling Luminance: Produced by stray light from light sources within the field of view. This stray light is superimposed in the eye on top of the retinal image of the object of interest, which alters the apparent brightness of that object and the background in which it is viewed.

Volume-to-Capacity (v/c) Ratio (also called degree of saturation): Represents the sufficiency of an intersection to accommodate the vehicular demand.

Yield-to-Bus Law: A law requiring all motorists to yield to buses pulling away from a bus stop in order to reduce transit/vehicle conflicts.

REFERENCES

1. Federal Highway Administration (FHWA). *Manual on Uniform Traffic Control Devices*. Washington, DC: U.S. Department of Transportation (USDOT), 2009.
2. Transportation Research Board (TRB). *Highway Capacity Manual 2010*. Washington, DC: TRB, National Research Council (NRC), 2010.
3. American Association of State Highway and Transportation Officials (AASHTO). *A Policy on Geometric Design of Highways and Streets*. Washington, DC: AASHTO, 2011.
4. FHWA. Safety and Operations Electronic Reading Room. <http://www.fhwa.dot.gov/tfhrc/safety/intro.htm>. Accessed May 2004.
5. National Highway Traffic Safety Administration (NHTSA). *Traffic Safety Facts 2002: A Compilation of Motor Vehicle Crash Data from the Fatality Analysis Reporting System and the General Estimates System*. Washington, DC: USDOT, 2003.
6. Rodegerdts, L., et al., *NCHRP Report 672: Roundabouts: An Informational Guide, Second Edition*. Washington, DC: Transportation Research Board of the National Academies, 2010.
7. Americans with Disabilities Act (ADA). Public Law 226, 101st Congress. July 26, 1990.
8. U.S. Architectural and Transportation Barriers Compliance Board (U.S. Access Board). *Proposed Accessibility Guidelines for Pedestrian Facilities in the Public Right-of-Way*, July 26, 2011.
9. FHWA, *Driver Expectancy in Highway Design and Operations*. FHWA-TO-86-1. Washington, DC: USDOT, May 1986.
10. Institute for Transportation Engineers (ITE). *Traffic Safety Toolbox: A Primer on Traffic Safety*. Washington, DC: ITE, 1999.
11. American Association of State Highway and Transportation Officials (AASHTO). *Highway Safety Manual, 1st Edition*. Washington, DC: AASHTO, 2010.
12. Smiley, A., C. MacGreger, and R. Dewar. *Evaluation of Prototype Highway Tourist Signs for Ontario*. Prepared by Human Factors North for the Ontario Ministry of Transportation, Research and Development Branch. Ontario, Canada: June 1996.
13. Eby, D. and L. Kostyniuk. *Estimating Driving Task Demand from Crash Probabilities: A Review of the Literature and Assessment of Crash Databases*. 2004. <https://www.volpe.dot.gov/safety-management-and-human-factors/surface-transportation-human-factors/estimating-driving-task>
14. Treat, J., N. Tumbas, S. McDonald, D. Shinar, R. Hume, R. Mayer, R. Stansfin, and N. Castellen. *Tri-level Study of the Causes of Traffic Accidents*. Report No. DOT-HS-034-3-535-77 (TAC), Indiana, 1977.
15. Staplin, L., K. Lococo, S. Byington, and D. Harkey. *Highway Design Handbook for Older Drivers and Pedestrians*. Report No. FHWA-RD-01-103. Washington, DC: USDOT, 2001.

16. FHWA. *Young Drivers and Highway Design and Operations: Findings and Recommended Research*. Report No. FHWA-RD-01-120. Washington DC: USDOT, 2001
17. Bureau of Transportation Statistics. *National Transportation Statistics 2010*. "Table 1-11: Number of U.S. Aircraft, Vehicles, Vessels, and Other Conveyances." Washington, DC: USDOT, 2010.
18. Fatality Analysis Reporting System. "Fatality Facts 2009: Pedestrians." <https://www.iihs.org/topics/fatality-statistics/detail/pedestrians>
19. Insurance Institute for Highway Safety, Fatality Facts, Passenger Vehicles.
20. American Association of State Highway and Transportation Officials. *Highway Safety Manual* (2010), Table 10-6.
21. Slack, K., *NCHRP Report 500: Guidance for Implementation of the AASHTO Strategic Highway Safety Plan*. Washington, DC: Transportation Research Board of the National Academies, 2000.
22. NHTSA. Traffic Safety Facts 2008. <https://crashstats.nhtsa.dot.gov/Api/Public/ViewPublication/811162>
23. Mohamedshad, Y., L. Chen, and F. Council. *Association of Selected Intersection Factors with Red-Light-Running Crashes*. Report No. FHWA-RD-00-12. Washington, DC: USDOT, 2000.
24. NHTSA. *Traffic Safety Factors*. "Distracted Driving 2009." Report No. DOT HS 811 379. Washington, DC: 2010, p. 11.
25. Sing, S. *Distracted Driving and Driver, Roadway, and Environmental Factors*. Report No. DOT HS 811 380, National Highway Traffic Safety Administration. Washington, DC: 2010, p. 12.
26. AASHTO. *Guide for the Development of Bicycle Facilities, 4th Edition*. Washington, DC: AASHTO, 2012.
27. FHWA. *Selecting Roadway Design Treatments to Accommodate Bicycles*. Report No. FHWA-RD-02-073. Washington, DC: USDOT, January 2004.
28. Pein, W. E. *Trail Intersection Design Guidelines*. Prepared for State Bicycle/Pedestrian Program, State Safety Office, Florida Department of Transportation. Highway Safety Research Center, University of North Carolina. September 1996.
29. Danish Road Directorate. *Collection of Cycle Concepts*. Copenhagen, Denmark: Road Directorate: 2000.
30. USDOT, Pedestrian and Bicycle Information Center, "How Many Bicyclists are Killed and Injured Each Year?" web page. <http://www.bicyclinginfo.org/faqs/answer.cfm?id=40>
31. NHTSA. *NHTSA Traffic Safety Facts 2009*, "Bicyclists and Other Cyclists." Report No. DOT HS 811 386. Washington, DC: 2010.
32. FHWA. *Injuries to Pedestrians and Bicyclists: An Analysis Based on Hospital Emergency Department Data*. Report No. FHWA-RD-99-078. Washington, DC: USDOT, 1999.
33. FHWA. *Pedestrian and Bicycle Crash Types of the Early 1990s*. Report No. FHWA-RD-95-163. Washington, DC: USDOT, 1995.

34. FHWA. *Summary of Travel Trends: 2009 National Household Travel Survey*. "Table 7. Average Annual Person Trips Per Household by Mode of Transportation and MSA Size 1977, 1983, 1990, and 1995 NPTS, and 2001 and 2009 NHTS." Report No. FHWA-PL-II-022, Washington, DC: USDOT, 2011, p. 16.
35. Fruin, J. J. *Pedestrian Planning and Design*. New York: Metro Association of Urban Designers and Environmental Planning, 1971.
36. U.S. Department of Justice, *ADA Standards for Accessible Design (ADAAG)*. 2010.
37. Kirschbaum, J. B., P. W. Axelson, P.E. Longmuir, K. M. Mispagel, J. A. Stein, and D. A. Yamada. *Designing Sidewalks and Trails for Access, Part II of II: Best Practices Design Guide*. Report No. FHWA-EP-01-127. Washington, DC: USDOT, September 2001.
38. Zegeer, C.V., C. Seiderman, P. Lagerway, M. Cynecki, M. Ronkin, and R. Schneider. *Pedestrian Facilities Users Guide—Providing Safety and Mobility*. Report No. FHWA-RD-01-102. Washington, DC: USDOT, 2002.
39. Leaf, W.A., and D.F. Preusser. *Literature Review on Vehicle Travel Speeds and Pedestrian Injuries*. Report No. DOT-HS-809-021. Washington, DC: USDOT, October 1999.
40. Florida Department of Transportation, *Florida Pedestrian Planning and Design Handbook*, April 1999.
41. Taoka, G.T. "Statistical Evaluation of Brake Reaction Time," *Compendium of Technical Papers*, 52nd Annual Meeting of ITE, Chicago, IL, pp. 30-36, August 1982.
42. ITE, *Trip Generation Manual, 8th Edition: An ITE Informational Report*. Washington, DC: 2008.
43. Minnesota Department of Transportation. "Intersection Control Evaluation (ICE)." Technical Memorandum No. 07-02-T-01, March 20, 2007, p 2.
<http://dotapp7.dot.state.mn.us/edms/download?docId=700081>
44. ITE. *ITE Traffic Engineering Handbook*. 6th edition, W.H. Kraft, ed. Washington, DC: ITE, 2009.
45. Bonneson, J. and M. Fontaine. *NCHRP Report 457: Evaluating Intersection Improvements: An Engineering Study Guide*. Washington, DC: Transportation Research Board of the National Academies, 2010
46. Woodson, W.E., B. Tillman, and P. Tillman. *Human Factors Design Handbook: Information and Guidelines for the Design of Systems, Facilities, Equipment, and Products for Human Use*, Second Edition. New York: McGraw-Hill, Inc., 1992.
47. Gattis, J. L., and S. T. Low. *Intersection Angle Geometry and the Driver's Field of View*. Final Technical Report 1073. University of Arkansas, March 1998, p. 38.
48. AASHTO. *Guide for the Planning, Design, and Operation of Pedestrian Facilities*. 1st Edition. Washington, DC: AASHTO, 2004.
49. FHWA. *Federal Lands Highway Project Development and Design Manual*. "Chapter 9. Highway Design." Draft. August 2012. <http://flh.fhwa.dot.gov/resources/manuals/pddm/>

50. University of North Carolina Highway Safety Research Center. *Florida Pedestrian Planning and Design Handbook*. Florida Department of Transportation: April 1999.
51. City of Portland (Oregon). *City of Portland Pedestrian Design Guide*. Portland, OR: Office of Transportation, June 1998.
52. FHWA. Memorandum on ADAAG Detectable Warnings. May 6, 2002.
http://www.fhwa.dot.gov/environment/bicycle_pedestrian/guidance/accessibility_guidance/dwm.cfm.
53. U.S. Department of Justice. *2010 ADA Standards for Accessible Design*, "Chapter 7. Communication Elements and Features," Figure 705.1 Size and Spacing of Truncated Domes.
54. U.S. Architectural and Transportation Barriers Compliance Board (U.S. Access Board). *Proposed Accessibility Guidelines for Pedestrian Facilities in the Public Right-of-Way*, July 26, 2011.
55. FHWA *Alternative Intersections/Interchanges: Informational Report (AIIR)*. Report No. FHWA-HRT-09-060, Washington, DC: USDOT, 2010. <http://www.fhwa.dot.gov/publications/research/safety/09060/>
56. Seymour, E., J. Green, and J. Black. "The Permitted Lead-Lag Left-Turn Display." In *1994 Compendium of Technical Papers*, ITE, 64th Annual Meeting, La Jolla, CA, 1994.
57. Wainwright, W.S. "Tricks of the Trade: How to Get More Capacity at Your Signalized Intersections, at Low Cost and Without Compromising Safety." In *2003 Annual Meeting and Exhibit, CD Compendium*, ITE, 73rd Annual Meeting, Seattle, WA, August 24-27, 2003.
58. FHWA. *Alternative Intersections/Interchanges: Informational Report (AIIR)*. Report No. FHWA-HRT-09-060, Washington, DC: USDOT, 2010. <http://www.fhwa.dot.gov/publications/research/safety/09060/>
59. Bentzen, B.L., and L.S. Tabor. *Accessible Pedestrian Signals*. Document A-37. Washington, DC: U.S. Architectural and Transportation Barriers Compliance Board (U.S. Access Board), 1998.
60. Barlow, J.M., B.L. Bentzen, and L.S. Tabor. "Accessible Pedestrian Signals: Synthesis and Guide to Best Practice." *Research Results Digest Number 278*. Washington, DC: NCHRP, July 2003.
61. Noyce, D.A., and J.M. Barlow. *Interfacing Accessible Pedestrian Signals (APS) with Traffic Signal Control Equipment*. Washington, DC: U.S. Architectural and Transportation Barriers Compliance Board (U.S. Access Board), April 2003.
62. American Association of State Highway Transportation Officials (AASHTO). *Roadside Design Guide*. Washington, DC: AASHTO, 2002.
63. Missouri DOT. *Engineering Policy Guide, Section 902.5.37.3*. Jefferson City, MO,
<http://epg.modot.mo.gov>
64. Kell, J.H., and I.J. Fullerton. *Manual of Traffic Signal Design*, 2nd edition. Washington, DC: ITE, 1998.
65. Bonneson, J.A., and P.T. McCoy. *Manual of Traffic Detector Design*, 1st edition. Washington, DC: ITE, 1994.
66. FHWA. *Traffic Signal Timing Manual*. Report No. FHWA-HOP-08-024. Washington, DC: USDOT, FHWA, June 2008.

67. Wortman, R.H., and T.C. Fox. "A Reassessment of the Traffic Signal Change Interval." In *Transportation Research Record* 1069 (1986).
68. ITE. *Traffic Control Devices Handbook*, J.L. Pline, ed. Washington, DC: ITE, 2001.
69. ITE. *Traffic Signing Handbook*. Washington, DC: ITE, 1997.
70. Illuminating Engineering Society of North America (IESNA). *American National Standard Practice for Roadway Lighting*. Standard RP-8-00. June 2000 (Reaffirmed 2005).
71. Antonucci, N.D., K.K. Hardy, K.L. Slack, et al. *NCHRP Report 500 Volume 12: Guidance for Implementation of the AASHTO Strategic Highway Safety Plan*. Washington, DC: Transportation Research Board of the National Academies, 2004.
72. FHWA. *FHWA Road Safety Audit Guidelines*. Report No. FHWA-SA-06-06. Washington, DC: USDOT, 2006.
73. ITE. *Statistical Evaluation in Traffic Safety Studies*. Washington, DC: ITE, 1999.
74. USDOT. *Model Minimum Uniform Crash Criteria Guideline*. Third Edition. Washington, DC: USDOT, 2008.
75. Alexander, G. *Positive Guidance in Maryland: Guidelines and Case Studies*. Maryland State Highway Administration, 1997.
76. FHWA, *Retroreflective Borders on Traffic Signal Backplates: A South Carolina Success Story*. Report No. FHWA-SA-09-011. Washington, DC: USDOT, 2009.
77. FHWA, *Safety Evaluation of Advance Street Name Signs*. Report No. FHWA-HRT-09-029. Washington, DC: USDOT, 2009.
78. FHWA, Crash Modifications Factors (CMF) Clearinghouse. <http://www.cmfclearinghouse.org/>
79. Hauer, E. *Observational Before - After Studies in Road Safety*. Elsevier Science Ltd., Oxford, UK: 1997.
80. TRB. *Highway Capacity Manual*, Special Report 209. Washington, DC: TRB, 1985.
81. Chang, G.L., J. Joseph. *Empirical Investigation of Intersection Traffic Patterns Under Maryland Driving Populations—Analysis of the Critical-Lane Volume Method at Signalized Intersections*. College Park, MD: The University of Maryland at College Park, August 2001.
82. Harwood, D.W., M.T. Pietrucha, M.D. Wooldridge, R.E. Brydia, and K. Fitzpatrick. *NCHRP Report 375: Median Intersection Design*. Washington, DC: Transportation Research Board of the National Academies, 1995.
83. Radwan, A.E., K.C. Sinha, and H.L. Michael. *Development and Use of a Computer Simulation Model for the Evaluation of Design and Control Alternatives for Intersections of Minor Roads with Multilane Rural Highways*. Report Nos. FHWA-IN-79/8, FHWA-IN-79/9, and FHWA-IN-79/10. Joint Highway Research Project. West Lafayette, IN: Purdue University, July 1979.

84. Priest, R.V. "Statistical Relationships Between Traffic Volume, Median Width, and Accident Frequency on Divided Highway Grade Intersections." *Highway Research News*, No. 13. Washington, DC: Highway Research Board, NRC, June 1964.
85. Castronovo, S., P.W. Dorothy, and T.L. Maleck. "Investigation of the Effectiveness of Boulevard Roadways." In *Transportation Research Record* 1635 (1998).
86. Dorothy, P.W., T.L. Maleck, and S.E. Nolf. "Operational Aspects of Michigan Design for Divided Highways." *Transportation Research Record* 1579 (1997).
87. FHWA. *Vegetation Control for Safety: A Guide for Street and Highway Maintenance Personnel*. Report No. FHWA-RT-90-003. Washington, DC: USDOT, 1990.
88. Gluck, J., H.S. Levinson, and V.G. Stover. *NCHRP Report 420: Impacts of Access Management Techniques*. Washington, DC: Transportation Research Board of the National Academies, 1999
89. ITE. *Transportation and Land Development*, 2nd Edition. Washington, DC: ITE, 2002.
90. TRB. *Access Management Manual*. Washington, DC: TRB, 2003.
91. Xu, L. "Right Turns Followed by U-Turns vs. Direct Left Turns: A Comparison of Safety Issues." *ITE Journal*, November 2001, pp. 36-43.
92. Papayannoulis, V., J.S. Gluck, K. Feeney, and H.S. Levinson. "Access Spacing and Traffic Safety." In *Transportation Research Circular E-C019: Urban Street Symposium Conference Proceedings*, Dallas, TX, June 28-30, 1999. Washington, DC: TRB, NRC, December 2000.
93. McLean, J. *Transport Research Report 315: Practical Relationships for the Assessment of Road Feature Treatments*. Summary Report. Australian Road Research Board, 1997.
94. Colorado Department of Transportation. *Colorado Access Control Demonstration Project: Final Report*. Denver, CO: Colorado Department of Transportation, June 1985.
95. Maze, T., D. Plazak, P. Chao, J. K. Evans, E. Padgett, and J. Witmer. *Access Management Research and Awareness Program*, Phase IV Final Report. CTRE Management Project 97-1. Center for Transportation Research and Education: November 1999.
96. McCoy, P.T., and J.E. Heimann. "Effect of Driveway Traffic on Saturation Flow Rates at Signalized Intersections." *ITE Journal*, February 1990, pp. 12-15.
97. Vargas, F.A., and Y. Gautam. "Problem: Roadway Safety vs. Commercial Development Access." In *1989 Compendium of Technical Papers*, ITE, 59th Annual Meeting, San Diego, CA. Washington, DC: ITE, 1989, pp. 46-50.
98. ITE. *The Traffic Safety Toolbox: A Primer on Traffic Safety*. Washington, DC: ITE, 1999.
99. Rakha, H., A. Medina, H. Sin, F. Dion, M. Van Aerde, and J. Jenq. "Traffic Signal Coordination Across Jurisdictional Boundaries: Field Evaluation of Efficiency, Energy, Environmental, and Safety Impacts." *Transportation Research Record* 1727 (2000).
100. Avgoustis, A. *Quantifying the Safety Impacts of Intelligent Transportation Systems*. Master of Engineering Thesis, Civil Engineering Department, Virginia Polytechnic Institute and State University, 1999

101. Southeast Michigan Council of Governments. *SEMCOG Traffic Safety Manual*, Third Edition. 1998
102. Colorado Department of Transportation. *Colorado Access Control Demonstration Project: Final Report*. Denver, CO: Colorado Department of Transportation, June 1985.
103. Collura, J., J. Chang, E.W. Willhaus, and J. Gifford. "Traffic Signal Preemption and Priority: Technologies, Past Deployments, and System Requirements." In *2001 ITS America Conference Proceedings*, Miami Beach, FL, 2001.
104. Zegeer, C.V., and C. Seiderman. "Designing for Pedestrians." In *2001 Compendium of Technical Papers*, ITE, 71st Annual Meeting, Chicago, IL. Washington, DC: ITE, 2001.
105. UK Dept. of Transportation, London, England. *Killing Speed and Saving Lives*. See also Limpert, Rudolph. *Motor Vehicle Accident Reconstruction and Cause Analysis*. Fourth Edition. Charlottesville, VA: The Michie Company, 1994
106. King, M. "Calming New York City Intersections." *Transportation Research Circular E-C019: Urban Street Symposium Conference Proceedings*, Dallas, TX, June 28-30, 1999. Washington, DC: TRB, NRC, December 2000.
107. Walkinfo.org Pedestrian and Bicycle Information Center, "Crossing Enhancements." <http://www.walkinginfo.org/engineering/crossings-enhancements.cfm>
108. Retting, R.A., and R. Van Houten. "Safety Benefits of Advance Stop Lines at Signalized Intersections: Results of a Field Evaluation." *ITE Journal*, September 2000, pp. 47-49, 54.
109. Zegeer, C.V., and M.J. Cynecki. "Evaluation of Countermeasures Related to RTOR Accidents that Involve Pedestrians." *Transportation Research Record* 1059 (1986).
110. Lalani, N. and the ITE Pedestrian and Bicycle Task Force. *Alternative Treatments for At-Grade Pedestrian Crossings*. Washington, DC: ITE, 2001.
111. FHWA. Pedestrian Safety Countermeasure Deployment Project web site. http://safety.fhwa.dot.gov/ped_bike/tools_solve/ped_scdproj/
112. Washington State Department of Transportation (WSDOT). *Local Agency Safety Management System*. Olympia, WA: WSDOT, September 2000.
113. Lord, D., A. Smiley, and A. Haroun. "Pedestrian Accidents with Left-Turning Traffic at Signalized Intersections: Characteristics, Human Factors and Unconsidered Issues." Presented at TRB 77th Annual Meeting, 1998.
114. Zaidel, D.M., and I. Hocherman. "Safety of Pedestrian Crossings at Signalized Intersections." *Transportation Research Record* 1141 (1987).
115. Barlow, J. "Making Intersections Accessible for the Visually Impaired." In *2001 Compendium of Technical Papers*, ITE, 71st Annual Meeting, Chicago, IL. Washington, DC: ITE, 2001.
116. Van Houten, R., J.E.L. Malenfant, J. Van Houten, and R.A. Retting. "Auditory Pedestrian Signals Increase Pedestrian Observing Behavior at Signalized Intersections." Presented at TRB 77th Annual Meeting, 1998.

117. Allsbrook, L. "Pedestrian Signal Countdown Device." In *1999 Compendium of Technical Papers*, ITE, 69th Annual Meeting, Las Vegas, NV. Washington, DC: ITE, 1999.
118. Chester, D.C., and M. Hammond. "Evaluation of Pedestrians Understanding of Pedestrians Countdown Signals." In *1998 Compendium of Technical Papers*, ITE, 68th Annual Meeting, Toronto, Ontario, Canada. Washington, DC: ITE, 1998.
119. Markowitz, F., S. Sciortino, J.L. Fleck, and B.M. Yee. "Pedestrian Countdown Signals: Experience with an Extensive Pilot Installation." *ITE Journal*, January 2006, pp. 43-48. Updated by Memorandum: Olea, R., "Collision changes 2002-2004 and countdown signals." (February 7, 2006)
120. Van Houten, R., J.E. Malenfant, & R. Steiner. "Scanning 'eyes' symbol as part of the WALK signal: Examination across several intersection geometries and timing parameters." *Transportation Research Record* 1773 (2001): 75-81.
121. Van Houten, R., R.A. Retting, J. Van Houten, C.M. Farmer, and J.E.L. Malenfant. "Use of Animation in LED Pedestrian Signals to Improve Pedestrian Safety." *ITE Journal*, February 1999, pp. 30-38.
122. Zegeer, C, K. Opiela, and M. Cynecki. *Pedestrian Signalization Alternatives*. Report No. FHWA-RD-83-102. Washington, DC: USDOT, 1983.
123. New Jersey Department of Transportation. *Pedestrian Compatible—Planning and Design Guidelines*. Trenton, NJ: New Jersey Department of Transportation, 2001.
124. Elvik, R., T. Vaa, A. Erke, and M. Sorensen. *The Handbook of Road Safety Measures*. Second Edition. United Kingdom: Emerald Group Publishing, 2009.
125. King, M., *Walking Info Case Study No. 37, Zebra Crosswalk Markings*, New York, NY. http://www.walkinginfo.org/pedsafe/casestudy.cfm?CS_NUM=37
126. Herrstedt, L., M.A. Nielsen, L. Agústson, K.M.L. Krogsgaard, E. Jørgensen, and N.O. Jørgensen. *Safety of Cyclists in Urban Areas: Danish Experiences*. Copenhagen, Denmark: Danish Road Directorate, 1994.
127. Turner, S. A., Wood, G., Hughes, T., and Singh, R., "Safety Performance Functions for Bicycle Crashes in New Zealand and Australia." Presented at the 90th Annual Meeting of the Transportation Research Board, Washington, D.C., (2011)
128. Jensen, S.U., and M.A. Nielsen. "The Marking of Bicycle Crossings at Signalized Intersections" (in Danish). Summarized in *Nordic Road & Transport Research*, No. 1, 1997, p. 27.
129. Texas Transportation Institute. *TCRP Report 19: Guidelines for the Location and Design of Bus Stops*. Transit Cooperative Research Program. Washington, DC: Transportation Research Board of the National Academies, 1996.
130. Park, Y, and W.C. Kloos. "Applicability of Countermeasures to Implement Farside Travel Lane Bus Stops Case Study: Lloyd District Transit Hub, Portland, Oregon." In *1998 Compendium of Technical Papers*, ITE, 68th Annual Meeting, Toronto, Ontario, Canada. Washington, DC: ITE, 1998.
131. Shalah, F., A. Shalaby, B. Persaud, B., and A. Hadayeghi, "Analysis of Transit Safety at Signalized Intersections in Toronto." TRB 88th Annual Meeting Compendium of Papers CD-ROM. Washington, DC: 2009.

132. New York State Department of Transportation. *Accident Reduction Factors*. 2002.
133. FHWA. 9 Proven Safety Countermeasures Guidance Policy. 2008.
134. Eccles, K.A., and H.W. McGee. *A History of the Yellow and All-Red Intervals for Traffic Signals*. Washington, DC: ITE, 2001.
135. McGee, H., K. Moriarty, K. Eccles, et al. *NCHRP Report 731: Guidelines for Timing Yellow and All-Red Intervals at Signalized Intersections*. Washington, DC: Transportation Research Board of the National Academies, 2012.
136. Souleyrette, R. R., M. M. O'Brien, T. McDonald, H. Preston, and R. Storm. "Effectiveness of All-Red Clearance Interval on Intersection Crashes." Iowa State University, Center for Transportation Research and Education Report Number MN/RC-2004-26, 2004.
137. Bonneson, J., K. Zimmerman, C. Messer, D. Lord, and M. Wooldridge. *Development of Ramp Design Procedures for Facilities without Frontage Roads*. Report FHWA/TX-05/0-4538-2. Texas Department of Transportation, Austin, Texas, September 2004.
138. Retting, R.A. and Chapline, J.F. 2002. "Changes in Crash Risk Following Re-Timing of Traffic Signal Change Intervals." *Accident Analysis and Prevention* 34/2: 215-220.
139. Harkey, D., Srinivasan, R., Zegeer, C., Persaud, B., Lyon, C., Eccles, K., Council, F. M., and McGee, H., "Crash Reduction Factors for Traffic Engineering and Intelligent Transportation System (ITS) Improvements: State of Knowledge Report." *Research Results Digest* 299 (2005).
140. Ontario Ministry of Transportation. *Ontario Traffic Manual Book 12—Traffic Signals*. Toronto, Ontario, Canada: Ontario Ministry of Transportation, July 2001.
141. Bonneson, J.A.; Zimmerman, K.H.; and Brewer, M. 2002. *Engineering Measures to Reduce Red Light Running*. Texas Department of Transportation Report No. FHWA/TX-03/4027-2.
142. Harkey, D., et al., *NCHRP Report 617: Accident Modification Factors for Traffic Engineering and ITS Improvements*, Washington, DC: Transportation Research Board of the National Academies, 2008.
143. Murphy, B., "An Evaluation of the Safety Effects of Modifying Late Night Flash Signal Operations in North Carolina." TRB 88th Annual Meeting Compendium of Papers CD-ROM. Washington, D.C., (2009).
144. Hasson, P., P. Lutkevich, B. Ananthanarayanan, P. Watson, and R. Knoblauch. "Field Test for Lighting to Improve Safety at Pedestrian Crosswalks." Presented at the 2004 TRB Annual Meeting, Washington, DC, 2004.
145. Elvik, R. and Vaa, T., "Handbook of Road Safety Measures." Elsevier Science Ltd., Oxford, UK: 2004.
146. Rodegerdts, L., et. al., *NCHRP Report 672: Roundabouts: An Informational Guide*, Second Edition. Washington, DC: Transportation Research Board of the National Academies, 2010.
147. Markowitz, F., Sciortino, S., Fleck, J. L., and Yee, B. M., "Pedestrian Countdown Signals: Experience with an Extensive Pilot Installation." *ITE Journal*, January 2006, pp. 43-48.
148. Retting, R.A.; S. Mandavilli, E.R. Russell, and A.T. McCart. "Roundabouts, traffic flow and public opinion." *Traffic Engineering and Control* 47 (2006):268-72.

149. Russell, E.R., Mandavilli, S.; and Rys, M.J. *Operational Performance of Kansas Roundabouts: Phase II*. Report No. K-TRAN KSU-02-04, Manhattan, KS: Department of Civil Engineering, Kansas State University, 2004.
150. Brilon, W., B. Stuwe, and O. Drews. Sicherheit und Leistungsfähigkeit von Kreisverkehrsplätzen. FE Nr 77359/91. Bochum, Germany: Lehrstuhl für Verkehrswesen, Ruhr-Universität Bochum, 1993. Cited by: Elvik R. "Effects on road safety of converting intersections to roundabouts: a review of evidence from non-US studies." *Transportation Research Record* 1847 (2003):1-10.
151. Schoon, C. and J. van Minnen. "The safety of roundabouts in the Netherlands." *Traffic Engineering and Control* 35 (1994):142-48.
152. Persaud, B., E. Hauer, R. A. Retting, R. Vallurupalli, and K. Mucsi. "Crash Reductions Related to Traffic Signal Removal in Philadelphia." *Accident Analysis and Prevention* 29/6 (1997): 803-810.
153. Campbell, J.L., M.G. Lichy, J.L. Brown, et al. *NCHRP 600A: Human Factors Guidelines for Road Systems*. Washington DC: Transportation Research Board of the National Academies, 2008.
154. Bhesania, R.P. "Impact of Mast-Mounted Signal Heads on Accident Reduction." *ITE Journal*, October 1991, p. 25-29.
155. Thomas, G., D.Smith. "Effectiveness of Roadway Safety Improvements." Iowa State University, 2001.
156. Srinivasan, R., F. Council, C. Lyon, F. Gross, N. Lefler, and B. Persaud. "Evaluation of the Safety Effectiveness of Selected Treatments at Urban Signalized Intersections." TRB 87th Annual Meeting Compendium of Papers CD-ROM. Washington, D.C., 2008.
157. Sayed, T., W. Abdelwahab, and J. Nepomuceno. "Safety Evaluation of Alternative Signal Head Design." In *Transportation Research Record* 1635(1998).
158. Felipe, E., Mitic, D., and Zein, S. R., "Safety Benefits of Additional Primary Signal Heads." Vancouver, B.C., Insurance Corporation of British Columbia; G.D. Hamilton Associates, (1998)
159. Sayed, T., P. Leur, and J. Pump. "Safety Impact of Increased Traffic Signal Backboards Conspicuity." 2005 TRB 84th Annual Meeting: Compendium of Papers CD-ROM, Vol. TRB#05-16, Washington, D.C., 2005.
160. Sayed, T., H. Vahidi, and F. Rodriguez. "Advance Warning Flashers: Do They Improve Safety?" *Transportation Research Record* 1692 (1999).
161. Polanis, S. F., *Traffic Safety Toolbox: A Primer on Traffic Safety*. "Chapter 27. Low-Cost Safety Improvements." Washington, DC: Institution of Transportation Engineers, 1999. pp. 265-272.
162. Farragher, B.A., B.R. Weinholzer, and M.P. Kowski. "The Effect of Advanced Warning Flashers on Red Light Running: A Study Using Motion Imaging Recording System Technology at Trunk Highway 169 and Pioneer Trail in Bloomington, Minnesota." In *1999 Compendium of Technical Papers*, ITE, 69th Annual Meeting, Las Vegas, NV. Washington, DC: ITE, 1999.
163. Appiah, J., B. Naik, R. Wojtal, L. Rilett, "Safety Effectiveness of Actuated Advance Warning Systems." *Transportation Research Record* 2250 (2011).

164. Teply, S. "Safety Implications of Advanced Flashing Amber at Signalized Intersections." Presented at Traffic Safety Summit in Alberta VII, Annual Western Canada Traffic Association Conference, October 4-7, 1998.
165. Gross, F., N. Lefler, C. Lyon, and K. Eccles. "Safety Effectiveness of Advance Street Name Signs." TRB 89th Annual Meeting Compendium of Papers CD-ROM. Washington, D.C., 2010.
166. Laughland, J.C., L.E. Haefner, J.W. Hall, and D.R. Clough. *NCHRP Report 162: Methods for Evaluating Highway Safety Improvements*. Washington DC: Transportation Research Board of the National Academies, 1975.
167. Schaerer, P. *Engineering Studies for Snow Removal*. Special Report 115. Washington, DC: Highway Research Board, 1970.
168. Oh, S., D.R. Ragland, and C.Y. Chan. "Safety Performance of Experimental Pavement Types in California Using Before-and-After Comparisons." TRB 89th Annual Meeting Compendium of Papers CD-ROM. Washington, D.C., 2010.
169. Bray, J. "The Role of Crash Surveillance and Program Evaluation: NYSDOT's Skid Accident Reduction Program (SKARP)." Presented at 28th International Forum on Traffic Records and Highway Information Systems, Orlando, FL, 2002.
170. North Carolina Department of Transportation. "Safety Project Development Guide." http://www.doh.dot.state.nc.us/preconstruct/traffic/safety/project_guide/.
171. Abdel-Aty, M., Devarasetty, P. C., and Pande, A., "Safety Evaluation of Multilane Arterials in Florida." *Accident Analysis and Prevention*, 41 (2009): 4, pp. 777-788.
172. California Department of Transportation. *Local Assistance Program Guidelines*. "Chapter 9—Hazard Elimination Safety Program." 1997.
173. Hovey, P. W. and Chowdhury, M., "Development of Crash Reduction Factors." 14801(0), Ohio Department of Transport, 2005.
174. Dixon, K., M. Liebler, H. Zhu, M. Hunter, and B. Mattox. *NCHRP Report 612: Safe and Aesthetic Design of Urban Roadside Treatments*. Washington DC: Transportation Research Board of the National Academies, 2008.
175. David, N.A., and J.R. Norman. *Motor Vehicle Accidents in Relation to Geometric and Traffic Features of Highway Intersections: Volume II*. Report No. FHWA-RD-76-129. Washington, DC: USDOT, 1975.
176. FHWA. *The 1996 Annual Report on Highway Safety Improvement Programs*. Report No. FHWA-SA-96-040. Washington, DC: USDOT, 1996.
177. Zimmerman, K. and Bonneson, J., "In-Service Evaluation of the Detection-Control System for Isolated High-Speed Intersections." 2006 TRB 85th Annual Meeting: Compendium of Papers CD-ROM, Vol. TRB#06-1252, Washington, D.C., 2006.
178. Madsen, T. and P. Baxandall, "Caution: Red Light Cameras Ahead." U.S. Public Interest Research Group (PIRG) Education Fund, 2011.

179. Eccles, K., R. Fiedler, B. Persaud, C. Lyon and G. Hansen. *NCHRP 729: Automated Enforcement for Speeding and Red Light Running*. Washington DC: Transportation Research Board of the National Academies, 2012
180. FHWA, "Red-Light Camera Enforcement: Implementation Guidance" website. http://safety.fhwa.dot.gov/intersection/redlight/cameras/jpl_guide.cfm
181. Oregon Department of Transportation. *Highway Design Manual*. Salem, OR: Oregon Department of Transportation, 2003.
182. Harwood, D. *NCHRP Report 330: Effective Utilization of Street Width*. Washington DC: Transportation Research Board of the National Academies, 1990.
183. FHWA. *Techbrief: Safety Evaluation of Offset Improvements for Left-Turn Lanes*, Report No. FHWA-HRT-09-036, June 2009.
184. Agent, K., N. Stamatiadis, and S. Jones. *Development of Accident Reduction Factors*. Kentucky Highway Research Program, Research Report KTC-96-13. Lexington, KY: University of Kentucky, 1996.
185. Oregon Department of Transportation. *Traffic Signal Policy and Guidelines*. Salem, OR: Oregon Department of Transportation, November 19, 1999.
186. ITE, Traffic Engineering Council Committee 5A-5, *Design and Safety of Pedestrian Facilities*. Washington, DC: ITE, 1998.
187. FHWA. *Development of Guidelines for Triple Left and Dual Right-turn Lanes*. Report No. FHWA/TX-11/0-6112-1. Washington, DC: USDOT, 2011.
188. Ackeret, K.W. "Criteria for the Geometric Design of Triple Left-Turn Lanes." *ITE Journal*, December 1994, pp. 27-33.
189. Ackeret, K.W., S.S. Nambisan, and R. Menon. "Evaluation of Side Swipe Crashes at Triple and Dual Turn Lanes in Las Vegas, Nevada." In *1999 Compendium of Technical Papers*, ITE, 69th Annual Meeting, Las Vegas, NV. Washington, DC: ITE, 1999.
190. Belluccia, A.G., G.L. Harter, and M.J. Rehtoric. "Triple Left-turn Lanes: Getting the First One Approved." In *1998 Compendium of Technical Papers*, ITE, 68th Annual Meeting, Toronto, Ontario, Canada. Washington, DC: ITE, 1998.
191. Dixon, K.K., J.L. Hibbard, and H. Nyman. "Right-Turn Treatment for Signalized Intersections." In *Transportation Research Circular E-C019: Urban Street Symposium Conference Proceedings*, Dallas, TX, June 28-30, 1999.
192. Washington State Department of Transportation (WSDOT). *Highway Design Manual*. Olympia, WA: Environmental and Engineering Services Center, WSDOT, September 2002.
193. Lin, F.B. "Right-Turn-on-Red Characteristics and Use of Auxiliary Right-Turn Lanes." *Transportation Research Record* 1010 (1985).
194. Tsao, S. M., and S. W. Ando. "A Study on Adjustment Factors for U-Turns in Left-Turn Lanes at Signalized Intersections." *Journal of Advanced Transportation*, 29 (1995): 2, pp. 183-192.

195. Nevers, B., et. al., *NCHRP Report 707: Guidelines on the Use of Auxiliary Through Lanes at Signalized Intersections*. Washington DC: Transportation Research Board of the National Academies, 2011.
196. James Clark School of Engineering, University of Maryland, "Auxiliary Lane Length" web page. http://attap.umd.edu/bbs/view.php?id=Tools&page=1&sn1=&divpage=1&sn=off&ss=on&sc=on&select_ arrange=headnum&desc=asc&no=1
197. USDOT, "Policy Statement on Bicycle and Pedestrian Accommodation Regulations and Recommendations." Washington, DC: 2010. http://www.fhwa.dot.gov/environment/bicycle_pedestrian/overview/policy_accom.cfm
198. FHWA, "Guidance Memorandum on Consideration and Implementation of Proven Safety Countermeasures." Washington, D.C.: 2008.
199. FHWA, *Safe Access is Good for Business*. Report No. FHWA-HOP-06-107. Washington, DC: USDOT, 2006.
200. Fitzpatrick, K., W. Schneider, and E. Park, "Operation and Safety of Right-turn Lane Designs." Transportation Research Board Annual Meeting. Washington, DC., 2006.
201. National Transportation Operations Coalition. *National Traffic Signal Report Card, 2012*. Washington, DC: ITE, 2012.
202. ITS Benefits and Costs Database, USDOT ITS Joint Program Office, <http://www.benefitcost.its.dot.gov/>
203. Surface Transportation Policy Partnership. "Transportation and the Environment" web page. <http://www.transact.org/library/factsheets/environment.asp>
204. Environmental Protection Agency. "Technology Transfer Network 1996 National-Scale Air Toxics Assessment" web page. <http://www.epa.gov/ttnatw01/nata/natsa1.html>
205. ITE. *Preemption of Traffic Signals Near Railroad Grade Crossings: An ITE Recommended Practice*. Washington, DC: ITE, 2006.
206. ITS America, *Transit Signal Priority (TSP): A Planning and Implementation Handbook*. Washington, DC: ITS America, 2005.
207. FHWA, *Safety Evaluation of Red Light Cameras*. Report No. FHWA-RT-05-048. Washington, DC: USDOT, 2005.

For More Information:

Visit <http://safety.fhwa.dot.gov/intersection>

FHWA, Office of Safety

Jeffrey Shaw
jeffrey.shaw@dot.gov
202.738.7793

Updated July 2020

FHWA-SA-13-027