

RAMP - TYPICAL SECTION

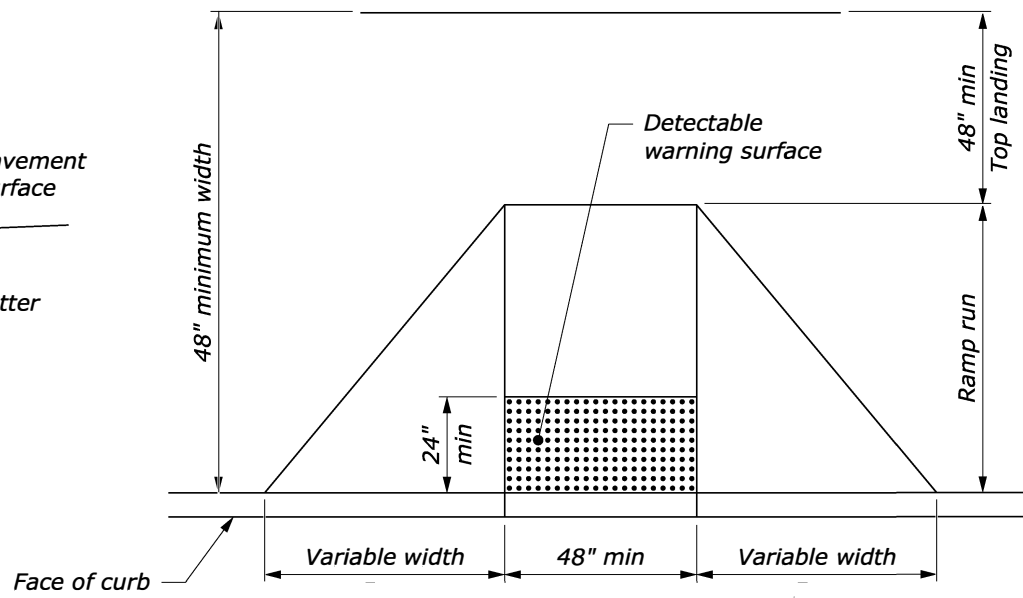

PERPENDICULAR CURB RAMP

NOTE:

1. The cross slopes of ramps must not exceed 1.5% in any direction.
2. Use a coarse broom finish running perpendicular to the running slope to create a slip resistant surface on concrete ramp surfaces, exclusive of the detectable warning surface.
3. Construct curb ramp perpendicular to the curb. Avoid skewing the ramp face.
4. Construct ramp transitions between walks, gutters, or streets that are flush and free of abrupt vertical changes not to exceed 0.25 inch.
5. Provide detectable warning surfaces that meet the Access Board's Public Right-of-Way Accessibility Guidelines.
6. Locate drainage inlets and manholes outside of ramp walking surfaces and landings.

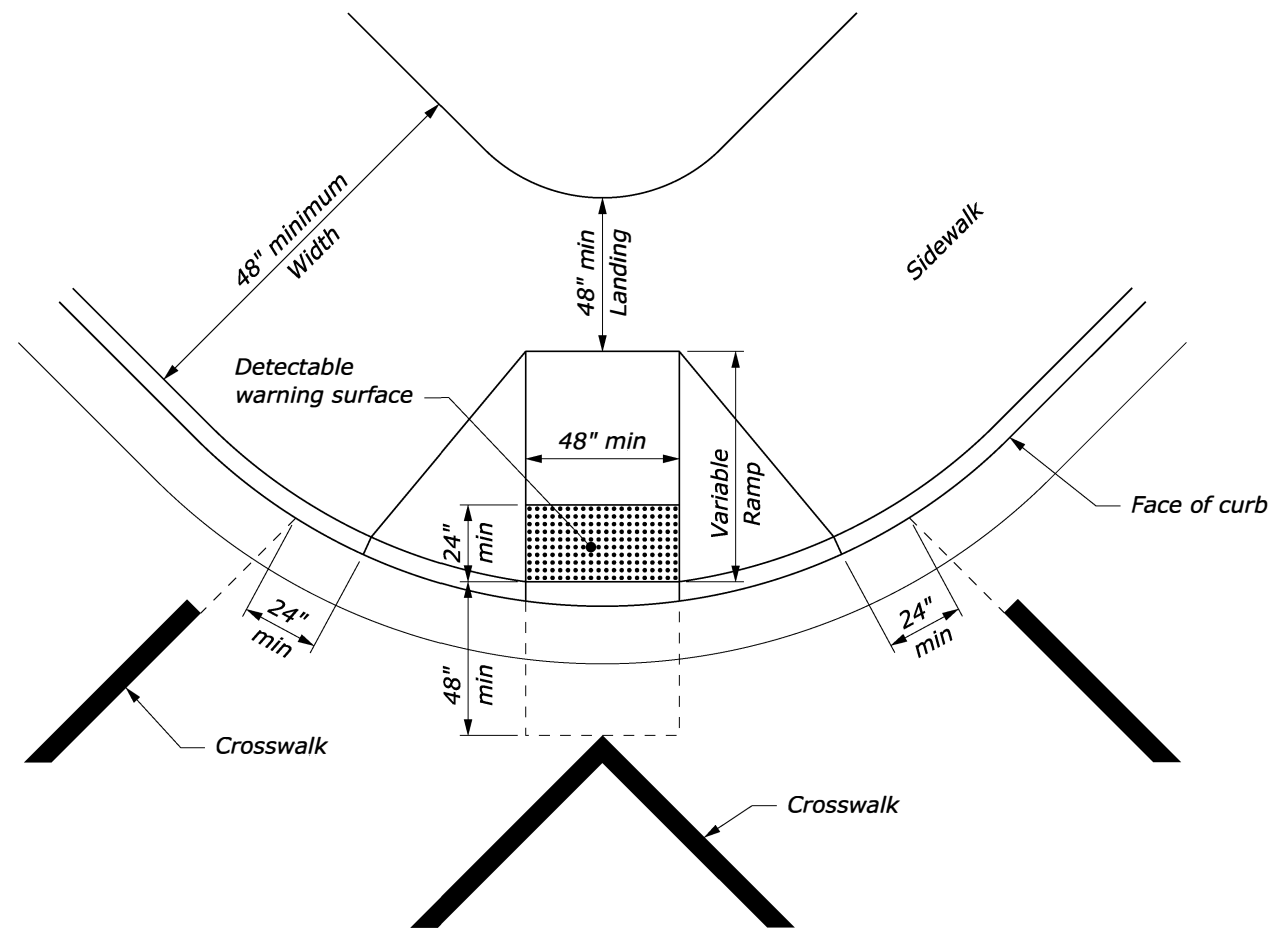

DIAGONAL CURB RAMP

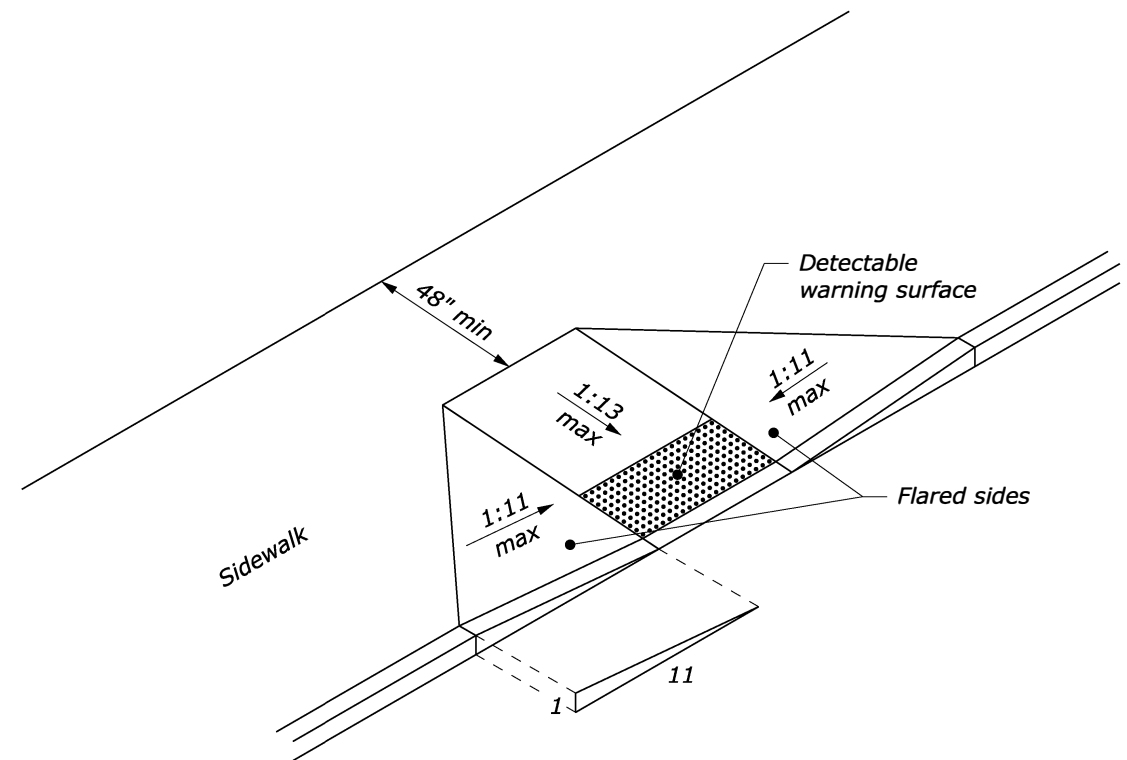

RAMP - ISOMETRIC

NO SCALE

U.S. DEPARTMENT OF TRANSPORTATION, FHWA
OFFICE OF FEDERAL LANDS HIGHWAY

**PERPENDICULAR
CURB RAMP**

FLH STANDARD
610-1

SPECIFICATION
FP-24

APPROVED FOR USE
8/2024

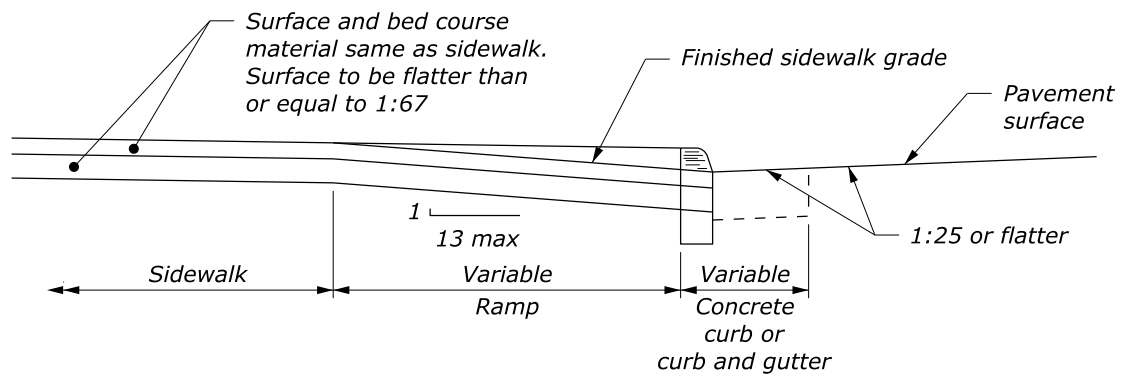

RAMP - TYPICAL SECTION

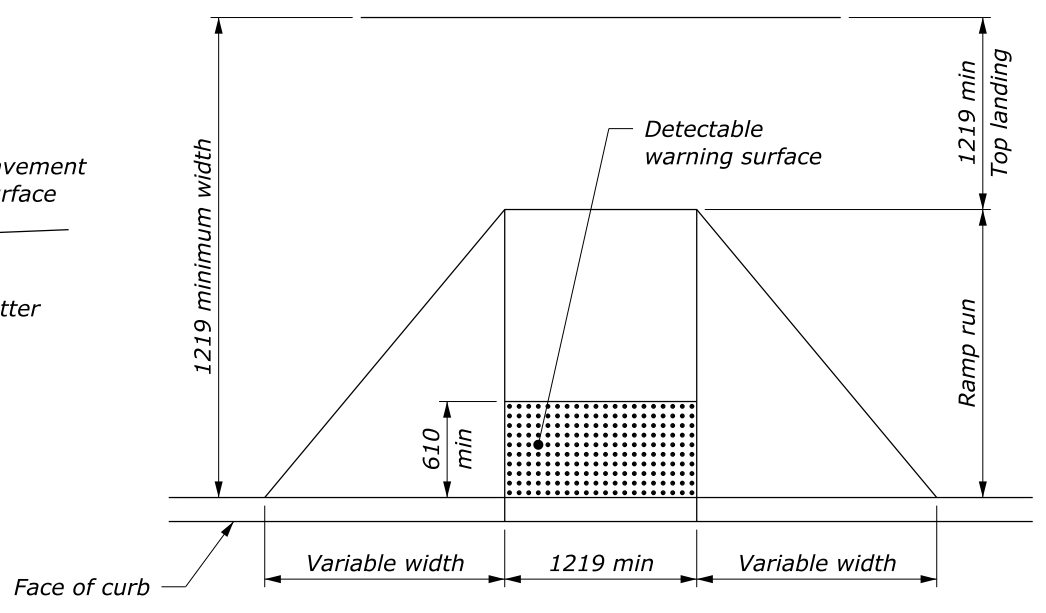

PERPENDICULAR CURB RAMP

NOTE:

1. The cross slopes of ramps must not exceed 1.5% in any direction.
2. Use a coarse broom finish running perpendicular to the running slope to create a slip resistant surface on concrete ramp surfaces, exclusive of the detectable warning surface.
3. Construct curb ramp perpendicular to the curb. Avoid skewing the ramp face.
4. Construct ramp transitions between walks, gutters, or streets that are flush and free of abrupt vertical changes not to exceed 6 mm.
5. Provide detectable warning surfaces that meet the Access Board's Public Right-of-Way Accessibility Guidelines.
6. Locate drainage inlets and manholes outside of ramp walking surfaces and landings.

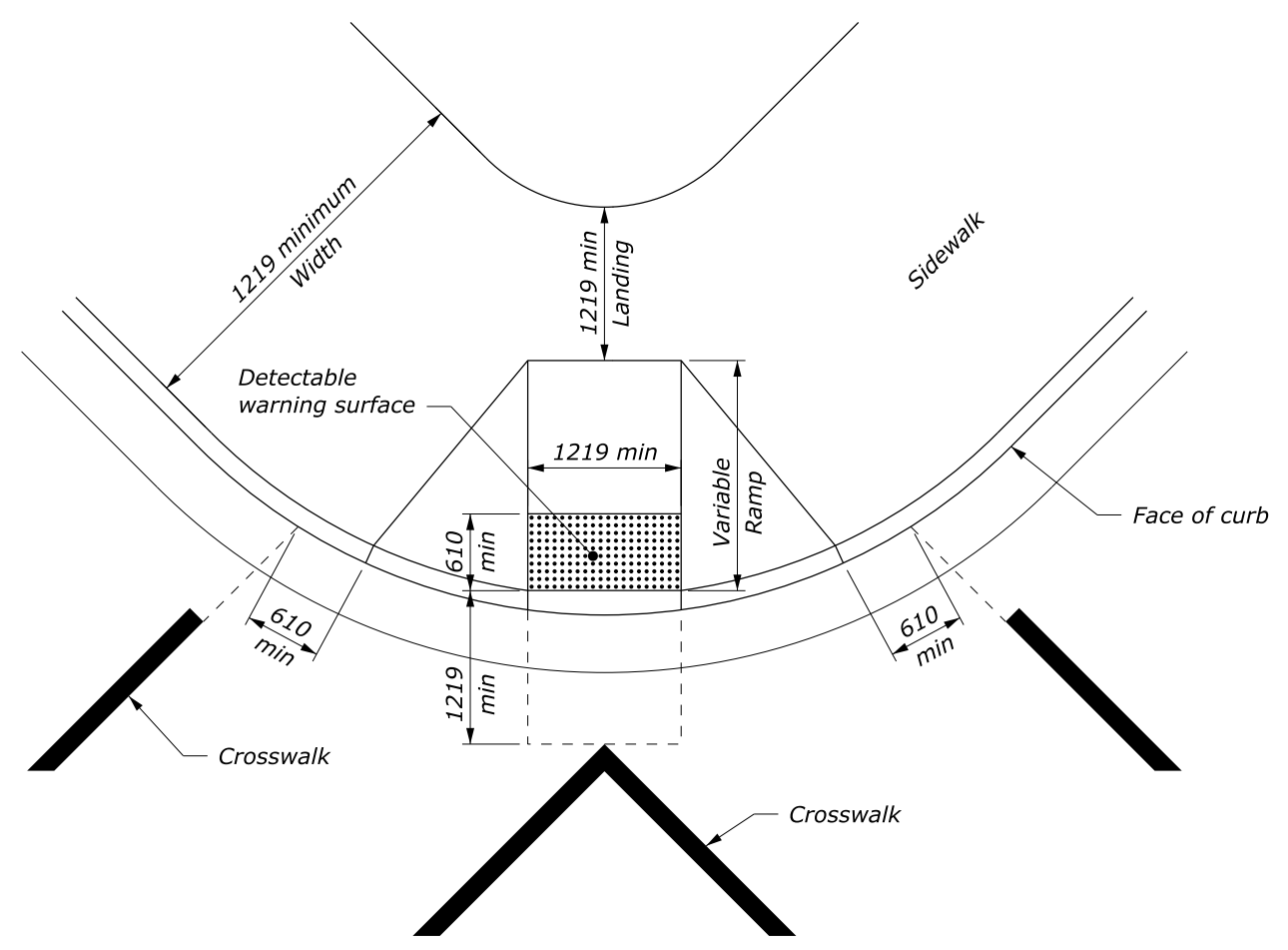

DIAGONAL CURB RAMP

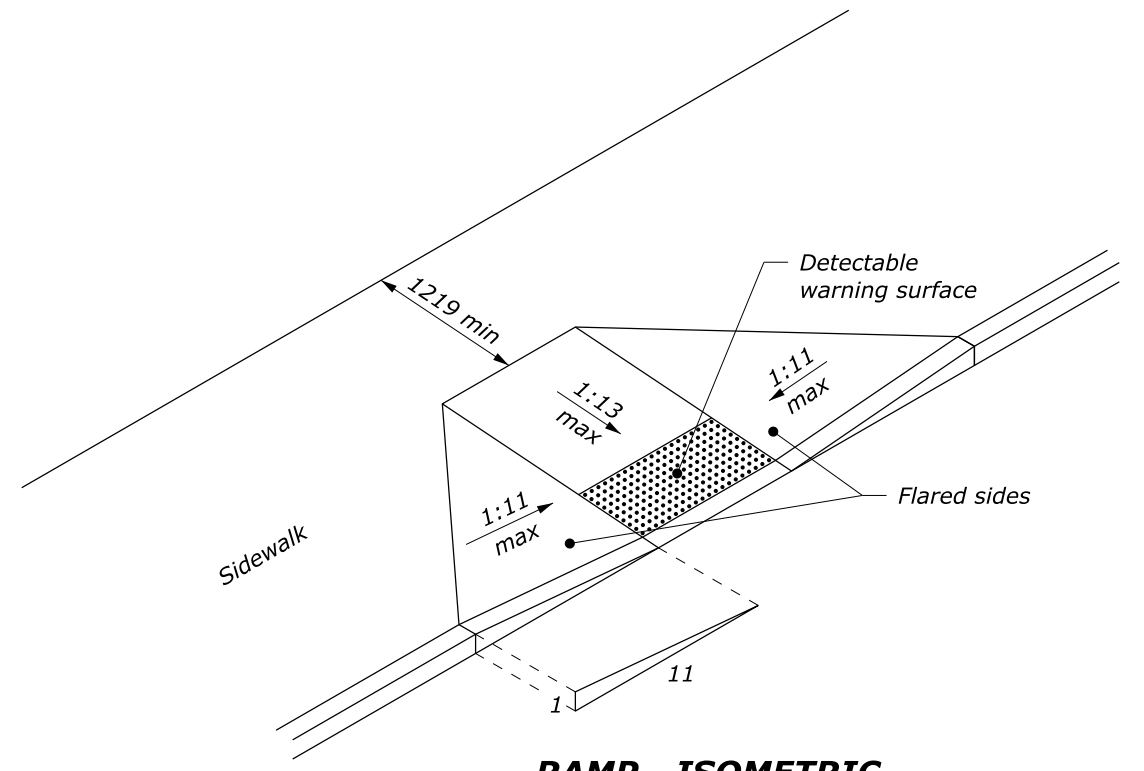

RAMP - ISOMETRIC

This drawing contains **Metric** units of measure. Dimensions without units are millimeters.

U.S. DEPARTMENT OF TRANSPORTATION, FHWA OFFICE OF FEDERAL LANDS HIGHWAY	FLH STANDARD M610-1
PERPENDICULAR CURB RAMP	SPECIFICATION FP-24
	APPROVED FOR USE 8/2024

NO SCALE