

**NOTES:**

1. Set all posts in concrete. Set corner, end, and pull posts to the dimensions shown. Set line posts to a minimum depth of 24 inches in concrete. Increase depth by 3 inches for each additional foot of fence height over 4 feet.
2. Adjust the post top elevations to provide a smooth visual fence profile. Install corner posts at horizontal breaks in the fence at 15° or more.
3. Provide fence fabric with a 2-inch mesh. Use 11-gage wire in fabric heights of 48 inches or less and 9-gage wire in fabric heights greater than 48 inches. Provide Class D coating when zinc-coated steel fence fabric is provided. Knuckle both selvages on fabric.
4. See Sheet 2 of 2 for hardware and gate requirements.

**CHAIN LINK FENCE**

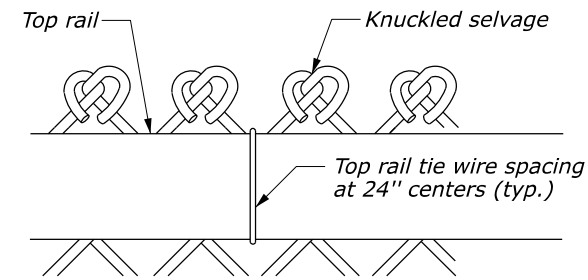

**WIRE SELVAGE DETAIL**

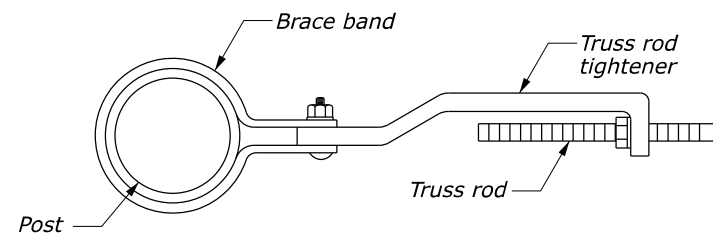

**TRUSS ROD TIGHTENER DETAIL**

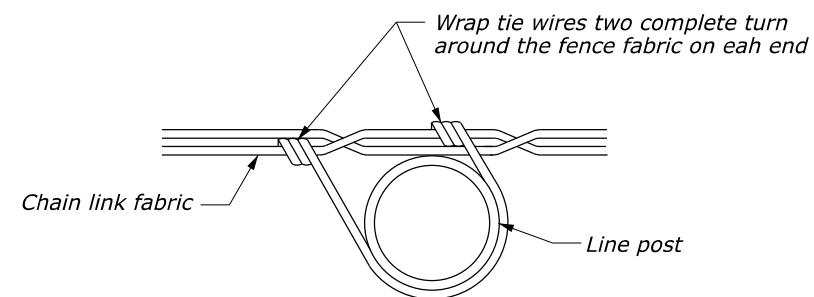

**CHAIN LINK FENCE TIE DETAIL**

NO SCALE

CHAIN LINK FENCE			
POST SIZE AND WEIGHT TABLE			
DESCRIPTION	FENCE HEIGHT	ROUND PIPE	
		Yield strength 25,000 Psi (min.)	
		dia. inch	lbs/ft (min.)
Brace rail & top rail	5 feet or less	1.315	0.740
	6 feet	1.315	0.740
Line post	5 feet or less	1.660	1.107
	6 feet	1.900	1.273
End, corner & pull post	5 feet or less	1.400	1.273
	6 feet	2.375	1.603

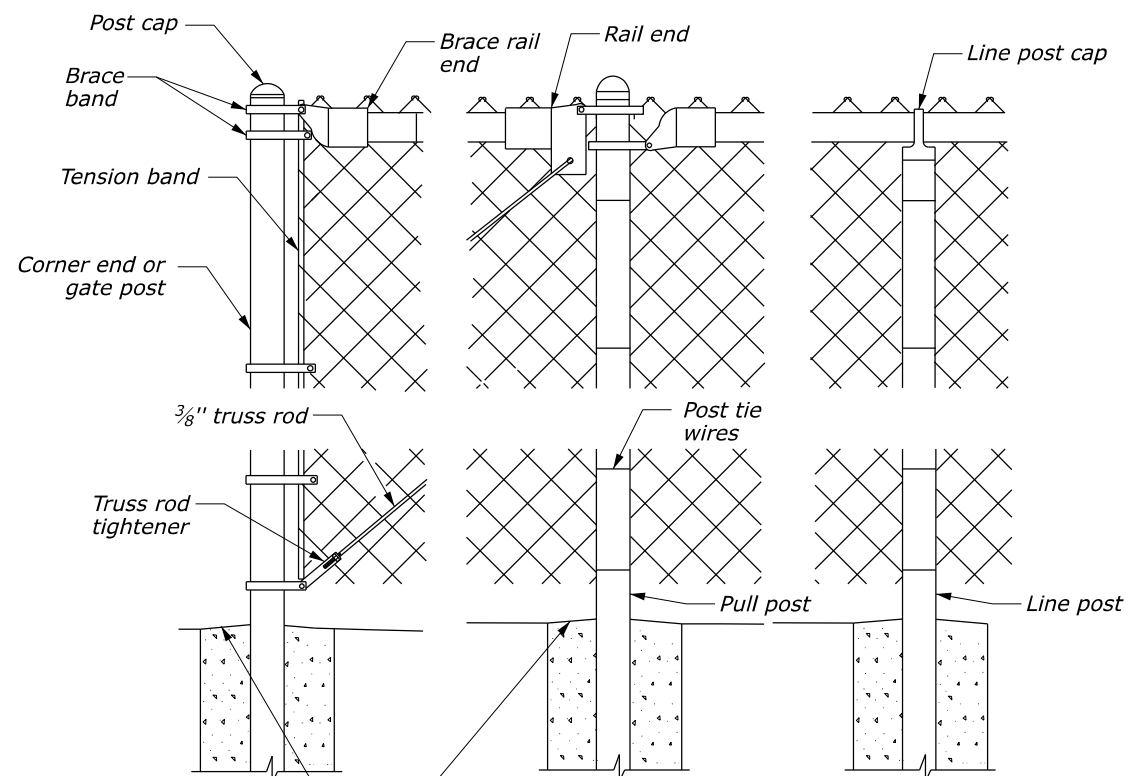

**CHAIN LINK DETAIL**

Convex surface to allow drainage from post (typ.)

U.S. DEPARTMENT OF TRANSPORTATION, FHWA  
OFFICE OF FEDERAL LANDS HIGHWAY













**RESIDENTIAL CHAIN LINK FENCE**

Sheet 1 of 2

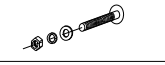
EFLHD DETAIL  
E619-07

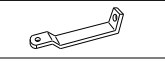
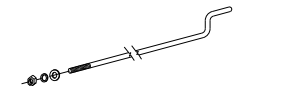
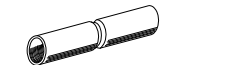
SPECIFICATION  
FP-14

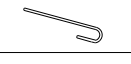
APPROVED FOR USE  
06/2024

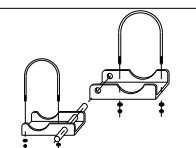
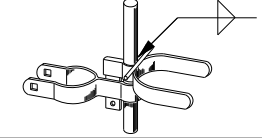
HARDWARE ITEM DESCRIPTION	STANDARD REQUIREMENTS
Brace rail and top rail 	See table on Detail E619-09, Sheet 1 of 2
Line post 	See table on Detail E619-09, Sheet 1 of 2
Corner; end and pull posts 	See table on Detail E619-09, Sheet 1 of 2
Post cap 	Cast non-ferrous alloy or galvanized pressed steel cap must fit snugly on post and gate top
Line post cap 	Galvanized pressed steel minimum $\frac{3}{32}$ " thickness or galvanized malleable ferrous alloy
Tension band 	Minimum $\frac{3}{32}$ " x $\frac{5}{16}$ " galvanized steel
Brace band 	Minimum $\frac{3}{32}$ " x $\frac{5}{16}$ " galvanized steel
Band bolt 	Minimum $\frac{5}{16}$ " x $1\frac{1}{4}$ " galvanized carriage bolt, (Lock washer & flat washer for each band)
Rail end 	Galvanized pressed steel or galvanized malleable ferrous alloy minimum $\frac{3}{8}$ " thickness on back bolting appendage
Brace rail end 	Galvanized pressed steel or galvanized malleable ferrous alloy minimum $\frac{3}{8}$ " thickness on back bolting appendage
Truss rod tightener 	Minimum $\frac{1}{4}$ " formed galvanized steel
Truss rod 	$\frac{3}{8}$ " galvanized, NC threaded rod, lock washer, & flat washer with two 90° bends opposite of threaded end
Top rail sleeve 	Galvanized steel 0.051" minimum thickness by 6" minimum length
Tension bar 	Minimum $\frac{3}{16}$ " x $\frac{3}{4}$ " galvanized steel
Fence fabric 	2" diamond mesh fabric, See Note 4 on Detail E619-07, Sheet 1 of 2
Tie wires 	Minimum 9 gage aluminum with one hooked end
Gate latch 	Minimum $\frac{1}{8}$ " galvanized pressed steel or malleable ferrous alloy. 1 latch per each single gate with bent minimum $\frac{3}{8}$ " attachment bolt, washer & nut.
Frame hinge 	Minimum $\frac{1}{8}$ " galvanized pressed steel with 2 - $\frac{3}{8}$ " U-bolts, lockwasher & nuts per hinge. Use 2 hinges per gate leaf up to 8' in width and 3 hinges per gate leaf widths greater than 8'.
Drop rod latch & guide 	Minimum $\frac{1}{8}$ " galvanized pressed steel. Drop rod guide includes $\frac{3}{8}$ " x 3" carriage bolt with lock washer & nut. Weld drop rod fork to rod & paint with an approved zinc rich paint.

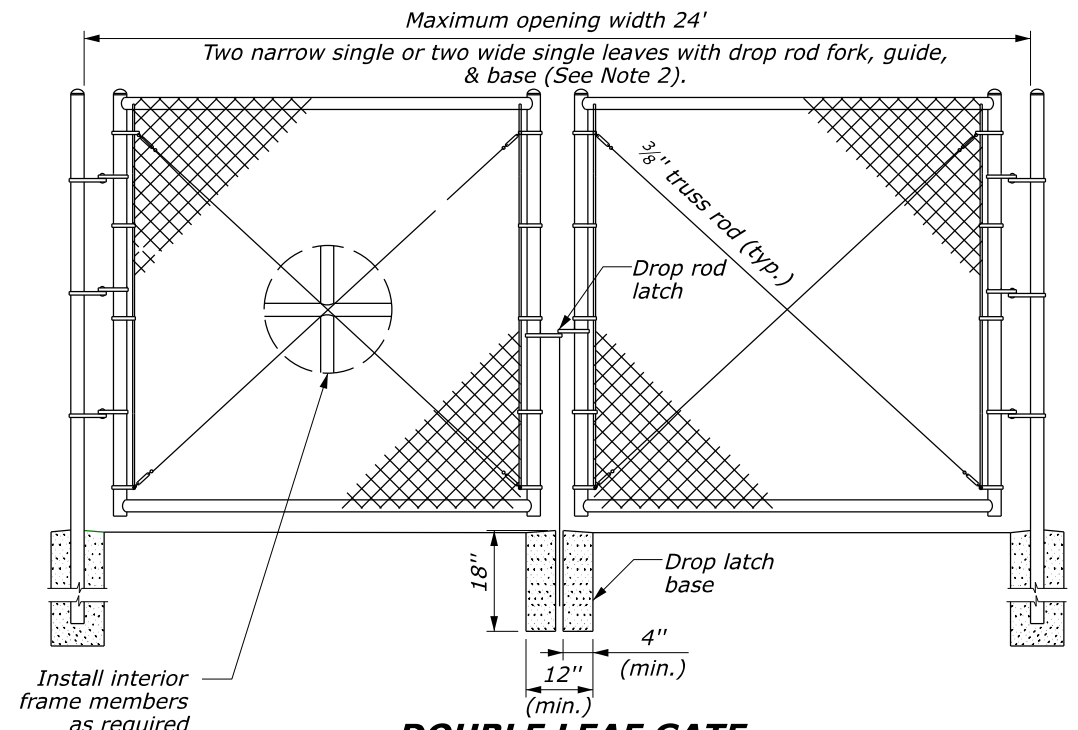

**DOUBLE LEAF GATE**

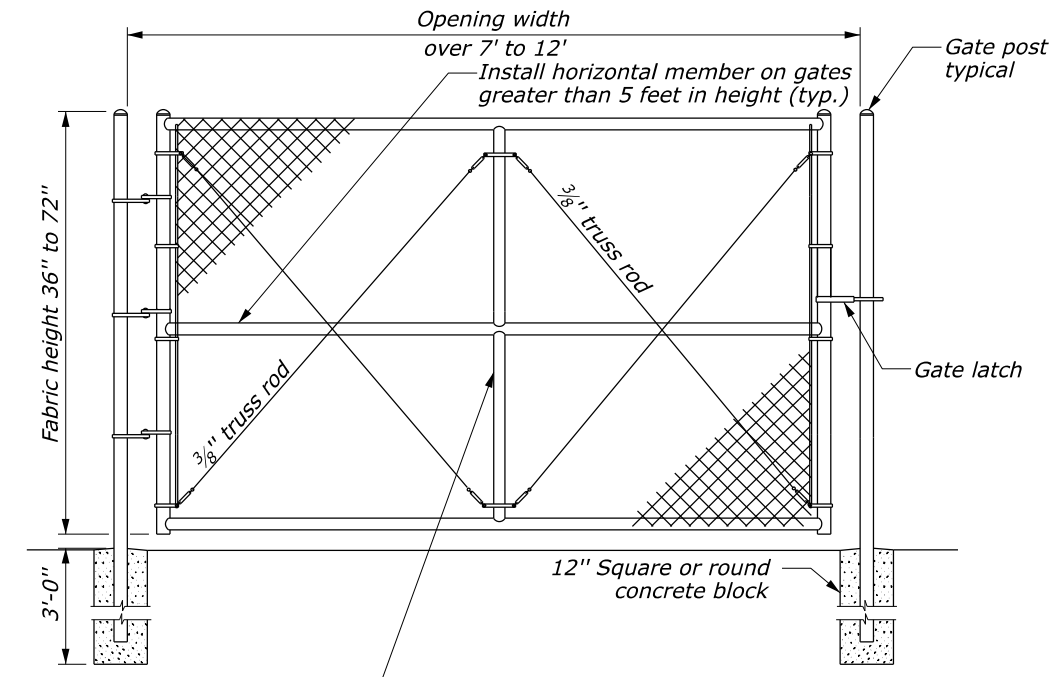

**WIDE SINGLE LEAF GATE**

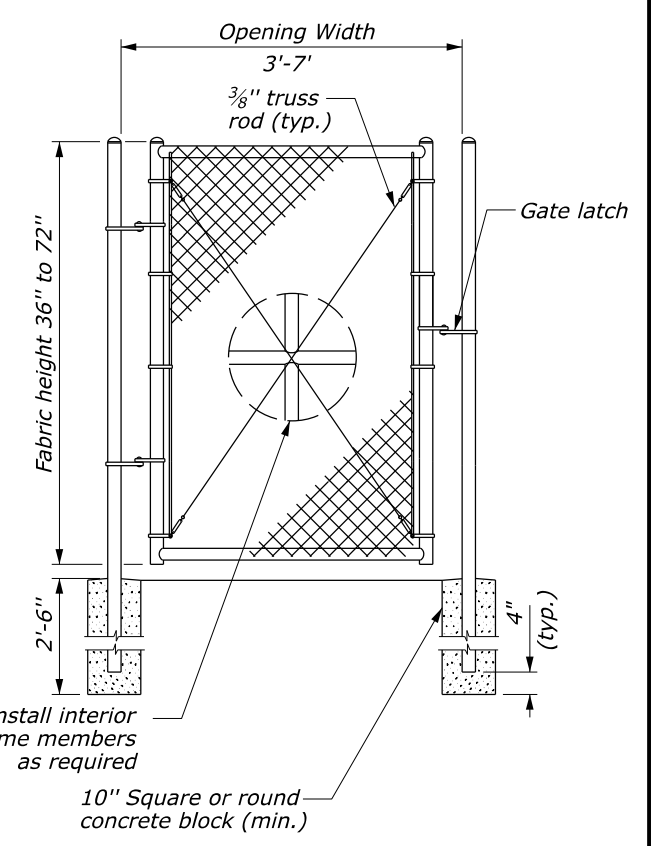

**NARROW SINGLE LEAF GATE**

Install equally spaced vertical uprights so that no horizontal dimension between outside members is greater than 5 feet

Install interior frame members as required

**CHAIN LINK GATE**

GATE LEAF WIDTHS		Minimum yield strength 25,000 Psi							
		ROUND TUBING				SQUARE TUBING			
		Steel		Aluminum		Steel		Aluminum	
		dia. inch	lbs/ft (min.)	dia. inch	lbs/ft (min.)	dia. inch	lbs/ft (min.)	dia. inch	lbs/ft (min.)
4 feet or less	Gate post size	1.90	1.257	1.90	0.866	2 x 2	2.35	2 x 2	0.94
Over 4 feet to 7 feet		2.375	2.135	2.375	1.260	2.5x2.5	2.728	2.5x2.5	1.265
Over 7 feet		2.375	3.117	2.375	2.00	2.5x2.5	3.882	2.5x2.5	2.904
Outside frame member	frame size	1.315	0.866	1.315	0.435	1.25x1.25	1.048	1.25x1.25	0.576
Interior bracing member		1.315	0.866	1.315	0.435	1.25x1.25	1.048	1.25x1.25	0.576

NO SCALE

**NOTES:**

1. Reinforce the gate frame corners with a malleable iron or pressed steel fitting designed for the purpose or shop weld the corners. Grind smooth all welds and paint each gate with the necessary hinges, latch, and drop rod locking device design for the type of gate posts used on the project. Provide positive type latching devices with provisions for pad locking at all gates. Provide keepers to retain the gate in the open position.
2. Use alternate gate frames constructed of steel section, other than pipe, as approved.
3. The design of the chain link hardware may vary from the details shown. Ensure all hardware and materials used in a single installation are uniform and compatible.

U.S. DEPARTMENT OF TRANSPORTATION, FHWA OFFICE OF FEDERAL LANDS HIGHWAY	EFLHD DETAIL E619-07
<b>RESIDENTIAL CHAIN LINK FENCE HARDWARE AND GATE</b>	SPECIFICATION FP-14
Sheet 2 of 2	APPROVED FOR USE 06/2024